



BAHCO



www.bahco.com

Catálogo-Tarifa **2024**

Catálogo-Tarifa 2024

Catálogo

Contenido	2-9
Capítulos	
Sierras de cinta y otras sierras para máquinas	11-20
Limas	21-36
Llaves	37-60
Llaves de vaso y carracas	61-102
Herramientas dinamométricas	103-122
Accesorios para herramientas eléctricas	123-186
Destornilladores	187-220
Llaves tipo allen	221-230
Alicates	231-264
Llaves para tubos y herramientas para fontanería	265-272
Herramientas neumáticas	273-288
Herramientas inalámbricas	289-294
Herramientas para automoción	295-356
Equipos de iluminación	357-358
Herramientas de inspección	359-362
Extractores	363-372
Almacenamiento de herramientas y composiciones	373-470
Herramientas para trabajos en altura	471-490
Herramientas aisladas	491-504
Herramientas antichispa	505-524
Herramientas de acero inoxidable	525-530
Pinzas y herramientas especiales para electrónica	531-536
Medición y trazado	537-546
Herramientas para pared	547-554
Arcos de sierra manuales	555-558
Serruchos	559-568
Formones	569-574
Tijeras y cuchillos	575-586
Mordazas y tornillos de banco	587-590
Martillos	591-598
Herramientas forestales y de tala de árboles	599-602
Cinceles y punteros de chapista	603-610
Palanca desencofrar	611-614
Herramientas para plantación y cultivo	615-618
Herramientas de poda	619-638
Herramientas neumáticas de exterior	639-642
Lindstrom	643-664
Índice alfanumérico	665-745
Precio de la soldadura	746
Condiciones generales de Venta	747
Garantía	751

**12 SIERRAS DE CINTA Y OTRAS SIERRAS
PARA MÁQUINAS**



21-36 LIMAS



37-60 LLAVES



61-102 LLAVES DE VASO Y CARRACAS



103-122 HERRAMIENTAS DINAMOMÉTRICAS



123-186 ACCESORIOS PARA HERRAMIENTAS ELÉCTRICAS



187-220 DESTORNILLADORES



221-230 LLAVES TIPO ALLEN



231-264 ALICATES



265-272 LLAVES PARA TUBOS Y HERRAMIENTAS PARA FONTANERÍA



273-288 HERRAMIENTAS NEUMÁTICAS



289-294 HERRAMIENTAS INALÁMBRICAS



471-490 HERRAMIENTAS PARA TRABAJOS EN ALTURA



491-504 HERRAMIENTAS AISLADAS



505-524 HERRAMIENTAS ANTICHISPA



525-530 HERRAMIENTAS DE ACERO INOXIDABLE

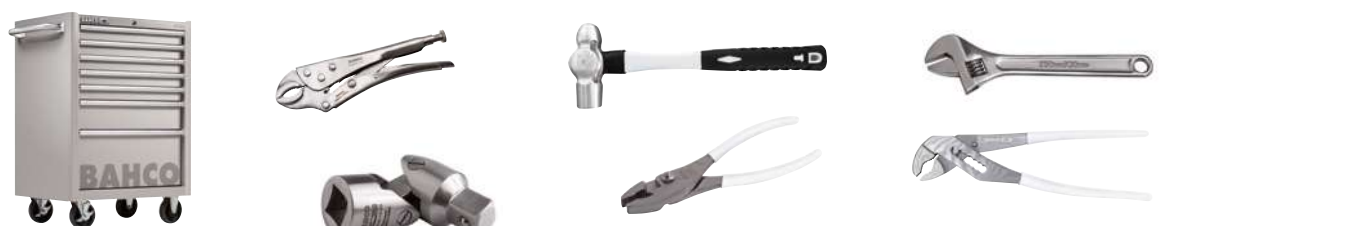

531-536 PINZAS Y HERRAMIENTAS ESPECIALES PARA ELECTRÓNICA



537-546 MEDICIÓN Y TRAZADO



547-554 HERRAMIENTAS PARA PARED



555-558 ARCOS DE SIERRA MANUALES



559-568 SERRUCHOS



569-574 FORMONES



575-586 TIJERAS Y CUCHILLOS



587-590 MORDAZAS Y TORNILLOS DE BANCO



591-598 MARTILLOS



599-602 HERRAMIENTAS FORESTALES Y DE TALA DE ÁRBOLES



603-610 CINCELES Y PUNTEROS DE CHAPISTA



611-614 PALANCA DESENCOFRAR



615-618 HERRAMIENTAS PARA PLANTACIÓN Y CULTIVO



619-638 HERRAMIENTAS DE PODA



639-642 HERRAMIENTAS NEUMÁTICAS DE EXTERIOR



643-666 LINDSTRÖM



Contenido

Sierras de cinta y otras sierras para máquinas	11-20	Destornilladores	187-220
SIERRAS DE CINTA BIMETÁLICAS PARA EL CORTE DE METAL	12	DESTORNILLADORES ERGO™ CON MANGO TRI-COMPONENTE	188
SIERRAS DE CINTA TRIMETÁLICAS PARA EL CORTE DE METAL	15	DESTORNILLADORES ERGO™ CON MANGO DE IMPACTO	198
SIERRAS DE CINTA DE METAL DURO PARA METAL	15	DESTORNILLADORES BAHCOFIT CON MANGO BI-MATERIAL	200
HOJA DE SIERRA PARA MADERA	17	DESTORNILLADORES CON MANGO DE GOMA	208
SIERRAS DE CINTA PARA CORTE DE AISLAMIENTO	17	DESTORNILLADORES CON MANGO DE CARRACA	211
SIERRAS CIRCULARES DE ACERO RÁPIDO	17	DESTORNILLADORES CON MANGO DE PRECISIÓN	212
HOJAS DE SIERRA DE MÁQUINA	18	DESTORNILLADORES CON MANGO EN T	215
ACCESORIOS PARA SIERRAS DE CINTA	20	DESTORNILLADORES PORTAPUNTAS DE 1/4"	216
		DESTORNILLADORES CON MANGO DE MADERA O PLÁSTICO	217
Limas	21-36	COMPROBADORES ELÉCTRICOS	219
LIMAS DE MECÁNICO	22	IMANTADOR DESTORNILLADORES	219
LIMAS PARA AFILADO	26		
ESCOFINAS	30	Llaves tipo allen	221-230
LIMAS CON DIENTES FRESADOS	31	CON PUNTA HEXAGONAL	222
LIMAS DE AGUJA	31	CON PUNTA TORX®	226
LIMAS DE DIAMANTE	34	ACODADAS	229
ACCESORIOS	35	MULTIHERRAMIENTAS	229
Llaves	37-60	Alicates	231-264
LLAVES AJUSTABLES "INGLESAS"	38	ALICATES DE CORTE	232
LLAVES COMBINADAS	40	ALICATES UNIVERSALES	239
LLAVES DE CARRACA	45	ALICATES DE MANIPULACIÓN	241
LLAVES FIJAS DE DOS BOCAS	48	TENACILLAS ARTICULADAS	247
LLAVES DE ESTRELLA DE DOS BOCAS	52	ALICATES PARA ARANDELAS	249
LLAVES PARA RACORES	54	PELACABLES Y HERRAMIENTAS PARA DESMONTAJE	251
LLAVES DE GOLPEO	55	ALICATES PARA TERMINALES	254
LLAVES DE TUBO	56	JUEGOS DE ALICATES	257
LLAVES UNIVERSALES	59	MORDAZAS DE PRESION	259
LLAVES DE GANCHO ARTICULADAS	60	REMACHADORAS	263
		ALICATES ESPECIALES	264
Llaves de vaso y carracas	61-102	Llaves para tubos y herramientas para fontanería	265-272
JUEGOS DE VASOS	62	LLAVES PARA TUBOS	266
1/4"	78	HERRAMIENTAS DE CORTATUBOS	268
3/8"	85	HERRAMIENTAS DE DOBLADO Y CONFORMADO	270
1/2"	91	HERRAMIENTAS DE REBABADO	271
3/4"	98		
1"	101		
CAJAS VACÍAS PARA JUEGOS DE VASOS	102		
LLAVES DE CARRACA PARA ESTRUCTURAS	102		
Herramientas dinamométricas	103-122	Herramientas neumáticas	273-288
LLAVES DINAMOMÉTRICAS DIGITALES	104	PISTOLAS DE IMPACTO NEUMÁTICAS	274
LLAVES DINAMOMÉTRICAS MECÁNICAS	106	CARRACAS NEUMÁTICAS	277
DESTORNILLADORES DINAMOMÉTRICOS	111	AMOLADORAS, LIJADORAS Y PULIDORAS NEUMÁTICAS	277
MULTIPLICADORES	113	TALADRO NEUMÁTICO	282
COMPROBADORES DE PAR	114	HERRAMIENTAS DE CORTE	283
ADAPTADORES DE PAR Y ÁNGULO	115	MARTILLOS, REMACHADORAS Y MARCADORES	284
HERRAMIENTAS DE INSERCIÓN	115	PISTOLAS DE PINTAR	285
JUEGOS DE MALETAS VACÍAS PARA HERRAMIENTAS DINAMOMÉTRICAS	121	HERRAMIENTAS DE SOPLADO Y LIMPIEZA	286
		EQUIPAMIENTO Y ACCESORIOS PARA HERRAMIENTAS NEUMÁTICAS	286
Accesorios para herramientas eléctricas	123-186	Herramientas inalámbricas	289-294
CORONAS DE SIERRA	124	LLAVES DE IMPACTO	290
HOJAS DE SABLE	134	CARRACAS	290
HOJAS DE CALAR	138	TALADROS Y ATORNILLADORES	291
ACCESORIOS MULTIHERRAMIENTAS	139	AMOLADORAS, LIJADORAS Y PULIDORAS INALÁMBRICAS	292
HOJAS PARA SIERRAS CIRCULARES	141	HERRAMIENTAS DE CORTE	292
DISCOS ABRASIVOS	142	ENGRASADORAS	293
SIERRAS DE CINTA	143	BATERÍAS Y CARGADORES	293
LIMAS ROTATIVAS DE CARBURO	144		
BROCAS	148		
PUNTAS DESTORNILLADOR	156		
HERRAMIENTAS DE IMPACTO	172		



Herramientas para automoción 295-356

HERRAMIENTAS PARA MOTOR	296
HERRAMIENTAS PARA SISTEMAS DE ESCAPE	318
HERRAMIENTAS Y EQUIPAMIENTOS PARA CAMBIOS DE ACEITE	319
HERRAMIENTAS Y EQUIPOS PARA SISTEMAS DE FRENADO	324
HERRAMIENTAS PARA RUEDAS Y TRANSMISIÓN	328
HERRAMIENTAS Y EQUIPOS PARA SUSPENSIÓN	336
HERRAMIENTAS PARA BATERÍAS Y SISTEMAS ELÉCTRICOS	337
PRENSAS Y ACCESORIOS	341
EQUIPAMIENTO LIGERO	342
HERRAMIENTAS PARA CARROCERÍA	344
EQUIPOS DE ELEVACIÓN	349

Equipos de iluminación 357-358

LINTERNAS MANUALES	358
LINTERNAS PARA LA CABEZA	358
ENROLLADORES DE CABLE	358

Herramientas de inspección 359-362

ENDOSCOPIOS	360
ESTETOSCOPIOS	360
ESPEJOS	360
LUPAS	361

Extractores 363-372

MECÁNICO	364
PALANCAS	370
HERRAMIENTAS PARA RECOGIDA	371
HERRAMIENTAS PARA ROSCAS	371

Almacenamiento de herramientas y composiciones 373-470

CARROS DE HERRAMIENTAS	374
MALETAS RÍGIDAS	436
ARMARIOS Y PANELES	448
CAJAS DE HERRAMIENTAS METÁLICAS	456
CAJAS Y ESTUCHES DE PLÁSTICO	462
EQUIPOS TEXTILES Y DE PIEL	463

Herramientas para trabajos en altura 471-490

ALMACENAMIENTO DE HERRAMIENTAS Y CORDONES	472
LLAVES	475
LLAVES PARA TUBOS	477
LLAVES DE VASO Y CARRACAS TRABAJOS EN ALTURA	477
DESTORNILLADORES	480
ALICATES	482
HERRAMIENTAS DE CORTE	484
MARTILLOS, PALANCAS Y CINCELES	486
MEDICIÓN Y TRAZADO	488
HERRAMIENTAS DINAMOMÉTRICAS	489
HERRAMIENTAS DE SUJECCIÓN	489
OTRAS HERRAMIENTAS	489
GUANTES	490

Herramientas aisladas 491-504

DESTORNILLADORES AISLADOS	492
ALICATES AISLADOS	498
LLAVES AISLADAS	501
VASOS Y CARRACAS AISLADOS	502
TIJERAS Y CUCHILLOS AISLADOS	502
PINZAS AISLADAS	503
EQUIPOS DE PROTECCIÓN	503
JUEGOS DE HERRAMIENTAS AISLADAS	503

Herramientas antichispa 505-524

LLAVES ANTICHISPA	506
HERRAMIENTAS PARA FONTANERÍA	511
LLAVES DE VASO Y CARRACAS ANTICHISPA	512
DESTORNILLADORES ANTICHISPA	515
ALICATES ANTICHISPA	516
MARTILLOS, PALANCAS Y CINCELES	518
RASQUETAS	521
HERRAMIENTAS DE JARDINERÍA	523
EXTRACTORES	523
LLAVES DINAMOMÉTRICAS ANTICHISPA	524

Herramientas de acero inoxidable 525-530

LLAVES ACERO INOXIDABLE	526
LLAVES DE VASO Y CARRACAS ACERO INOXIDABLE	527
DESTORNILLADORES DE ACERO INOXIDABLE	528
LLAVES ACODADAS	528
PUNTAS ACERO INOXIDABLE	529
ALICATES ACERO INOXIDABLE	529
MARTILLOS DE ACERO INOXIDABLE	530
CINCELES Y PUNTEROS DE CHAPISTA	530

Pinzas y herramientas especiales para electrónica 531-536

PINZAS ELECTRONICA	532
HERRAMIENTAS DE SOLDADURA	535
HERRAMIENTAS PARA MECÁNICA DE PRECISIÓN	535

Medición y trazado 537-546

FLEXÓMETROS Y CINTAS MÉTRICAS	538
RUEDAS DE MEDICIÓN	539
NIVELES	539
MARCADO	542
REGLAS	543
ESCUADRAS	544
MEDICIÓN DE PRECISIÓN	545

Herramientas para pared 547-554

RASCADORES	548
HERRAMIENTAS PARA ALBAÑILERÍA	550
HERRAMIENTAS PARA PAREDES DE PLACAS DE ESCAYOLA	552

Arcos de sierra manuales 555-558

ARCOS DE SIERRA	556
HOJAS DE ARCOS DE SIERRA	557

Serruchos 559-568

SERRUCHOS PARA MATERIALES DE CONSTRUCCIÓN	560
SERRUCHOS PARA MADERA	561
SERRUCHOS DE PRECISIÓN	565
MANGOS Y AFILADORES	566
HOJAS Y ARCOS DE MARQUETERÍA	566
ARCOS Y HOJAS PARA RECORTE	567
SERRUCHO "MUSICAL"	567

Formones 569-574

FORMONES	570
CINCELES GUBIA	572
CINCELES DE DEMOLICIÓN	572
ACCESORIOS PARA FORMONES	573

Tijeras y cuchillos 575-586

TIJERAS CORTACHAPAS	576
TIJERAS ELECTRICISTA	579
CUCHILLOS	580

Mordazas y tornillos de banco 587-590

MORDAZAS DE BANCO	588
TORNILLOS DE BANCO	589
ACCESORIOS PARA TORNILLOS DE BANCO	590

Martillos 591-598

MARTILLOS DE CARPINTERO	592
EXTRACTORES DE CLAVOS	593
MARTILLOS DE MECÁNICO	593
MARTILLOS PARA CONSTRUCCIÓN	594
MARTILLOS ESPECIALES	596
MARTILLOS SLEDGE	596
MARTILLOS Y MAZAS BLANDOS	597

Herramientas forestales y de tala de árboles 599-602

HACHAS, ALCOTANAS Y MAZAS	600
CUÑAS	601

Cinceles y punteros de chapista 603-610

CINCELES DE CHAPISTA	604
CINCELES DE CHAPISTA CON PROTECCIÓN	605
CINCELES DE CHAPISTA (REAFILABLES)	605
CINCELES DE CHAPISTA - ACCESORIOS	606
PUNTEROS	606
PUNTEROS CON MANGO BIMATERIAL	610
CINCELES DE CHAPISTA CON MANGO BIMATERIAL	610

Palanca desencofrar 611-614

BARRAS DESENCOFRADORAS	612
------------------------	-----

Herramientas para plantación y cultivo 615-618

PEQUEÑAS HERRAMIENTAS DE JARDINERÍA	616
-------------------------------------	-----

Herramientas de poda 619-638

TIJERAS DE PODA UNA MANO	620
HERRAMIENTAS PARA RECOGIDA DE FRUTA	624
TIJERAS DE PODAR DE DOS MANOS	624
SERRUCHOS CON PÉRTIGA Y PODADERAS DE ALTURA	626
CORTASETOS	630
TIJERAS CORTACÉPESDES	631
NAVAJAS DE PODA	632
TIJERAS FLORALES	632
ARCOS TRONZADORES	633
SERRUCHOS DE PODA	634
REPUESTOS Y ACCESORIOS	636
ACCESORIOS Y MANTENIMIENTO	636

Herramientas neumáticas de exterior 639-642

TIJERAS DE PODA NEUMÁTICAS	640
----------------------------	-----

Lindström 643-666**Cortantes de precisión**

ALICATES CORTE DIAGONAL	644
ALICATES CORTE DIAGONAL, CABEZA ESPECIAL	645
ALICATES DE CORTE OBLICUO	645
ÁNGULO	646
CORTANTE PARA PLÁSTICO	647
CORTE CON PUNTA	648
ALICATES DE CORTE OBLICUO, CABEZA ESPECIAL	648
CORTANTES PUNTA MICRO	648
CIZALLAS MULTIUSOS	648
ACCESORIOS Y REPUESTOS	649

Cortantes de precisión para materiales duros

CORTANTE DE CARBURO	649
ALICATES CORTE DIAGONAL EXTRA REFORZADO	649
ALICATES CORTE DIAGONAL RENDIMIENTO ESPECÍFICO	649
ALICATES CORTE DIAGONAL RENDIMIENTO ESPECÍFICO, CABEZA ESPECIAL	650

Alicates de manipulación de precisión

BOCA PLANA	650
BOCA REDONDA	650
BOCA CADENA	651
ALICATE PARA CREAR CADENAS DE JOYERÍA	651
BOCA DOBLADA	651
BOCA SEMIRREDONDA, CABEZA ESPECIAL	651
BOCA SEMIRREDONDA, CABEZA ESPECIAL	652
BOCA AGUJA	652

Cortante especial

INSERCIÓN DE IC/HERRAMIENTA DE EXTRACCIÓN Y CORTANTES IC	652
CORTAR Y DOBLAR	652
CORTANTES STANDOFF	653
CORTE Y FORMA	653
LEADFORMERS	653

Alicates universales especiales

INSERCIÓN DE IC/HERRAMIENTA DE EXTRACCIÓN Y CORTANTES IC	654
LEADFORMERS	654

Alicate de precisión

CABEZA AFILADA	652
CABEZA PUNTIAGUDA	653
CABEZA OBLICUA	653

Destornilladores de Precisión

ESD	653
-----	-----

Pelacables

ALICATES CORTE DIAGONAL	654
-------------------------	-----

Cortantes "heavy duty"

ALICATES CORTE DIAGONAL	654
-------------------------	-----

Herramientas dinamométricas

DESTORNILLADORES DINAMOMÉTRICOS	654
---------------------------------	-----

Pinzas

JUEGOS DE PINZAS	655
PINZAS DE CORTE	656
PINZAS DE PRECISIÓN	656
PINZAS DE PLÁSTICO DE PUNTA	658
REEMPLAZABLE - FIBRA DE CARBONO	
PINZAS TÁCTILES ERGONÓMICAS CON SEGURIDAD ESD	658
PINZAS ECONÓMICAS	659
PINZAS SMD	660
COMPONENTES PINZAS DE POSICIONAMIENTO	662
PINZAS UNIVERSALES	662
REPUESTOS Y ACCESORIOS	662



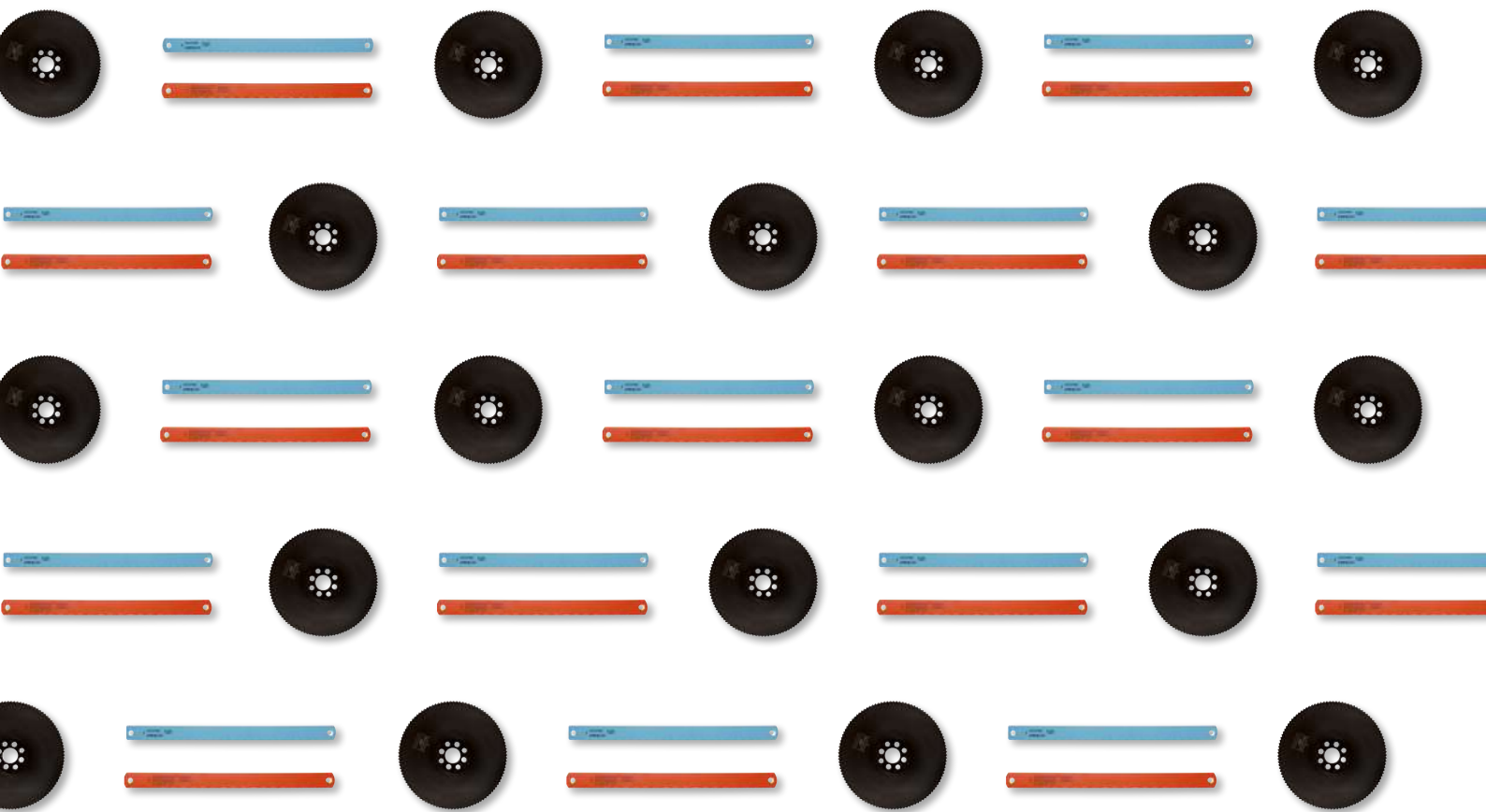

Sierras de cinta y otras sierras para máquinas



SIERRAS DE CINTA BIMETÁLICAS PARA EL CORTE DE METAL

Sierra cinta Easy Cut



3857 Easy-Cut

		€		
13 mm	EZ	9,81	1	3857-13-0.6-EZ-S
13 mm	EZ	9,81	1	3857-13-0.6-EZ-M
13 mm	EZ	9,81	1	3857-13-0.6-EZ-L
20 mm	EZ	10,91	1	3857-20-0.9-EZ-S
20 mm	EZ	10,91	1	3857-20-0.9-EZ-M
20 mm	EZ	10,91	1	3857-20-0.9-EZ-L
27 mm	EZ	12,43	1	3857-27-0.9-EZ-S
27 mm	EZ	12,43	1	3857-27-0.9-EZ-M
27 mm	EZ	12,43	1	3857-27-0.9-EZ-L
34 mm	EZ	15,26	1	3857-34-1.1-EZ-S
34 mm	EZ	15,26	1	3857-34-1.1-EZ-M
34 mm	EZ	15,26	1	3857-34-1.1-EZ-L

Sandflex® Cobra™

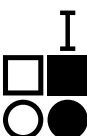

3851 Contour and small machine

		€		
6 mm	PRX	8,66	1	3851-6-0.6-10/14
6 mm	Hook	8,66	1	3851-6-0.6-H-6
6 mm	PRX	8,66	1	3851-6-0.9-10/14
6 mm	Hook	8,66	1	3851-6-0.9-H-6
10 mm	PRX	8,98	1	3851-10-0.6-10/14
10 mm	Hook	8,98	1	3851-10-0.6-H-4
10 mm	Hook	8,98	1	3851-10-0.6-H-6
10 mm	PRX	8,98	1	3851-10-0.9-10/14
10 mm	Hook	8,98	1	3851-10-0.9-H-4
10 mm	Hook	8,98	1	3851-10-0.9-H-6
10 mm	Regular	8,98	1	3851-10-0.9-R-14
13 mm	PRX	8,98	1	3851-13-0.5-10/14

		€		
13 mm	PRX	8,98	1	3851-13-0.5-14/18
13 mm	Regular	8,98	1	3851-13-0.5-R-10
13 mm	Regular	8,98	1	3851-13-0.5-R-14
13 mm	Regular	8,98	1	3851-13-0.5-R-18
13 mm	Regular	8,98	1	3851-13-0.5-R-24
13 mm	Hook	8,98	1	3851-13-0.5-H-4
13 mm	PRX	8,98	1	3851-13-0.6-10/14
13 mm	PRX	8,98	1	3851-13-0.6-5/8
13 mm	PRX	8,98	1	3851-13-0.6-6/10
13 mm	PRX	8,98	1	3851-13-0.6-8/12
13 mm	Hook	8,98	1	3851-13-0.6-H-3
13 mm	Hook	8,98	1	3851-13-0.6-H-4
13 mm	Hook	8,98	1	3851-13-0.6-H-6
13 mm	Regular	8,98	1	3851-13-0.6-R-10
13 mm	Regular	8,98	1	3851-13-0.6-R-14
13 mm	Regular	8,98	1	3851-13-0.6-R-18
13 mm	PRX	8,98	1	3851-13-0.9-10/14
13 mm	PRX	8,98	1	3851-13-0.9-6/10
13 mm	Hook	8,98	1	3851-13-0.9-H-3
13 mm	Hook	8,98	1	3851-13-0.9-H-4
13 mm	Hook	8,98	1	3851-13-0.9-H-6
13 mm	Regular	8,98	1	3851-13-0.9-R-14
13 mm	Regular	8,98	1	3851-13-0.9-R-6
20 mm	PRX	9,15	1	3851-20-0.9-10/14
20 mm	Hook	9,15	1	3851-20-0.9-H-3
20 mm	Hook	9,15	1	3851-20-0.9-H-4
20 mm	Regular	9,15	1	3851-20-0.9-R-18
20 mm	PRX	9,15	1	3851-20-0.9-4/6
20 mm	PRX	9,15	1	3851-20-0.9-5/8
20 mm	PRX	9,15	1	3851-20-0.9-6/10
20 mm	PRX	9,15	1	3851-20-0.9-8/12
27 mm	PS	9,30	1	3851-27-0.9-P-3
27 mm	PS	9,30	1	3851-27-0.9-P-4
27 mm	Regular	9,30	1	3851-27-0.9-R-6
34 mm	PS	13,67	1	3851-34-1.1-P-2
34 mm	PS	13,67	1	3851-34-1.1-P-3

Sandflex® Cobra™ Fundición



3851 Sandflex® Cobra™ Foundry

		€		
10 mm	HA	8,98	1	3851-10-0.6-HA-4
13 mm	HA	8,98	1	3851-13-0.6-HA-4
13 mm	HA	8,98	1	3851-13-0.6-HA-6
13 mm	HA	8,98	1	3851-13-0.9-HA-4
20 mm	HA	9,15	1	3851-20-0.9-HA-3
20 mm	HA	9,15	1	3851-20-0.9-HA-4
27 mm	HA	9,30	1	3851-27-0.9-HA-4
27 mm	HA	9,30	1	3851-27-0.9-HA-3



3851 Sandflex® Cobra™



		€		
27 mm	PRX	9,30	1	3851-27-0.9-2/3
27 mm	PRX	9,30	1	3851-27-0.9-3/4
27 mm	PRX	9,30	1	3851-27-0.9-4/6
27 mm	PRX	9,30	1	3851-27-0.9-5/8
27 mm	PRX	9,30	1	3851-27-0.9-6/10
27 mm	PRX	9,30	1	3851-27-0.9-8/12
27 mm	PRX	9,30	1	3851-27-0.9-10/14
34 mm	PRX	13,67	1	3851-34-1.1-2/3
34 mm	PRX	13,67	1	3851-34-1.1-3/4
34 mm	PRX	13,67	1	3851-34-1.1-4/6
34 mm	PRX	13,67	1	3851-34-1.1-5/8
34 mm	PRX	13,67	1	3851-34-1.1-6/10
41 mm	PRX	17,71	1	3851-41-1.3-1.4/2
41 mm	PRX	17,71	1	3851-41-1.3-2/3
41 mm	PRX	17,71	1	3851-41-1.3-3/4
41 mm	PRX	17,71	1	3851-41-1.3-4/6
41 mm	PRX	17,71	1	3851-41-1.3-5/8
54 mm	PRX	20,23	1	3851-54-1.3-1.4/2
54 mm	PRX	20,25	1	3851-54-1.3-2/3
54 mm	PRX	22,73	1	3851-54-1.3-3/4
54 mm	PRX	20,25	1	3851-54-1.3-4/6
54 mm	PR	20,25	1	3851-54-1.6-P-1.25
54 mm	PRX	20,25	1	3851-54-1.6-1/1.4
54 mm	PRX	20,25	1	3851-54-1.6-1.4/2
54 mm	PRX	20,25	1	3851-54-1.6-2/3
54 mm	PRX	20,25	1	3851-54-1.6-3/4
54 mm	PRX	20,25	1	3851-54-1.6-4/6
67 mm	PRX	35,08	1	3851-67-1.6-7/1
67 mm	PRX	35,08	1	3851-67-1.6-1/1.4
67 mm	PRX	35,08	1	3851-67-1.6-1.4/2
67 mm	PRX	35,08	1	3851-67-1.6-2/3
67 mm	PRX	35,08	1	3851-67-1.6-3/4
67 mm	PRX	35,08	1	3851-67-1.6-4/6
80 mm	PRX	52,69	1	3851-80-1.6-7/1
80 mm	PRX	52,69	1	3851-80-1.6-1/1.4
80 mm	PRX	52,69	1	3851-80-1.6-1.4/2

Hoja de sierra King Cobra



3854-Sandflex® King Cobra™ PHX



		€		
27 mm	PHX	10,45	1	3854-27-0.9-PHX-2/3
27 mm	PHX	10,45	1	3854-27-0.9-PHX-3/4
27 mm	PHX	10,45	1	3854-27-0.9-PHX-4/6

		€		
34 mm	PHX	14,63	1	3854-34-1.1-PHX-1.4/2
34 mm	PHX	14,63	1	3854-34-1.1-PHX-2/3
34 mm	PHX	14,63	1	3854-34-1.1-PHX-3/4
34 mm	PHX	14,63	1	3854-34-1.1-PHX-4/6
41 mm	PHX	18,95	1	3854-41-1.3-PHX-1.4/2
41 mm	PHX	18,95	1	3854-41-1.3-PHX-2/3
41 mm	PHX	18,95	1	3854-41-1.3-PHX-3/4
41 mm	PHX	18,95	1	3854-41-1.3-PHX-4/6
54 mm	PHX	26,39	1	3854-54-1.3-PHX-1.4/2
54 mm	PHX	26,39	1	3854-54-1.3-PHX-2/3
54 mm	PHX	26,39	1	3854-54-1.3-PHX-3/4
54 mm	PHX	29,89	1	3854-54-1.6-PHX-7/1
54 mm	PHX	29,89	1	3854-54-1.6-PHX-1/1.4
54 mm	PHX	29,89	1	3854-54-1.6-PHX-1.4/2
54 mm	PHX	29,89	1	3854-54-1.6-PHX-2/3
54 mm	PHX	29,89	1	3854-54-1.6-PHX-3/4
67 mm	PHX	37,54	1	3854-67-1.6-PHX-7/1
67 mm	PHX	37,54	1	3854-67-1.6-PHX-1/1.4
67 mm	PHX	37,54	1	3854-67-1.6-PHX-1.4/2
67 mm	PHX	37,54	1	3854-67-1.6-PHX-2/3
80 mm	PHX	56,38	1	3854-80-1.6-PHX-7/1
80 mm	PHX	56,38	1	3854-80-1.6-PHX-1/1.4
80 mm	PHX	56,38	1	3854-80-1.6-PHX-1.4/2

Sandflex® King Cobra™ PQ



3854-Sandflex® King Cobra™ PQ



		€		
27 mm	PQ	14,57	1	3854-27-0.9-PQ-3/4
27 mm	PQ	14,57	1	3854-27-0.9-PQ-4/6
34 mm	PQ	16,59	1	3854-34-1.1-PQ-2/3
34 mm	PQ	16,59	1	3854-34-1.1-PQ-3/4
34 mm	PQ	16,59	1	3854-34-1.1-PQ-4/6
41 mm	PQ	19,75	1	3854-41-1.3-PQ-1.4/2
41 mm	PQ	19,75	1	3854-41-1.3-PQ-2/3
41 mm	PQ	19,75	1	3854-41-1.3-PQ-3/4
41 mm	PQ	19,75	1	3854-41-1.3-PQ-4/6
54 mm	PQ	30,14	1	3854-54-1.6-PQ-9/1.2
54 mm	PQ	30,14	1	3854-54-1.6-PQ-1.4/2
54 mm	PQ	30,14	1	3854-54-1.6-PQ-2/3
54 mm	PQ	30,14	1	3854-54-1.6-PQ-3/4
54 mm	PQ	30,14	1	3854-54-1.6-PQ-4/6
67 mm	PQ	39,13	1	3854-67-1.6-PQ-9/1.2
67 mm	PQ	39,13	1	3854-67-1.6-PQ-1.4/2
67 mm	PQ	39,13	1	3854-67-1.6-PQ-2/3
80 mm	PQ	57,86	1	3854-80-1.6-PQ-9/1.2
80 mm	PQ	56,38	1	3854-80-1.6-PQ-1.4/2



Sandflex® King Cobra™ PQ



3858 PQ P9000

		€		
41 mm	PQ	25,63	1	3858-41-1.3-PQ-1.4/2
41 mm	PQ	25,63	1	3858-41-1.3-PQ-2/3
41 mm	PQ	25,63	1	3858-41-1.3-PQ-3/4
54 mm	PQ	39,06	1	3858-54-1.6-PQ-9/1.2
54 mm	PQ	39,06	1	3858-54-1.6-PQ-1.4/2
54 mm	PQ	39,06	1	3858-54-1.6-PQ-2/3
67 mm	PQ	51,26	1	3858-67-1.6-PQ-9/1.2
67 mm	PQ	51,26	1	3858-67-1.6-PQ-1.4/2
80 mm	PQ	73,24	1	3858-80-1.6-PQ-9/1.2

Hojas de sierra con dentado PHX

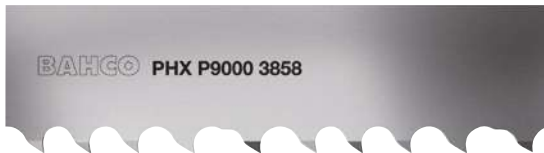

3858 PHX P9000

		€		
34 mm	PHX	15,50	1	3858-34-1.1-PHX-1.4/2
34 mm	PHX	15,50	1	3858-34-1.1-PHX-2/3
34 mm	PHX	15,50	1	3858-34-1.1-PHX-3/4
41 mm	PHX	20,75	1	3858-41-1.3-PHX-1.4/2
41 mm	PHX	20,75	1	3858-41-1.3-PHX-2/3
41 mm	PHX	20,75	1	3858-41-1.3-PHX-3/4
54 mm	PHX	26,85	1	3858-54-1.3-PHX-1.4/2
54 mm	PHX	26,85	1	3858-54-1.3-PHX-2/3
54 mm	PHX	26,85	1	3858-54-1.3-PHX-3/4
54 mm	PHX	26,85	1	3858-54-1.6-PHX-7/1
54 mm	PHX	26,85	1	3858-54-1.6-PHX-1/1.4
54 mm	PHX	26,85	1	3858-54-1.6-PHX-1.4/2
54 mm	PHX	26,85	1	3858-54-1.6-PHX-2/3
54 mm	PHX	26,85	1	3858-54-1.6-PHX-3/4
67 mm	PHX	36,62	1	3858-67-1.6-PHX-7/1
67 mm	PHX	36,62	1	3858-67-1.6-PHX-1/1.4
67 mm	PHX	36,62	1	3858-67-1.6-PHX-1.4/2
67 mm	PHX	36,62	1	3858-67-1.6-PHX-2/3
80 mm	PHX	43,21	1	3858-80-1.6-PHX-7/1
80 mm	PHX	43,21	1	3858-80-1.6-PHX-1/1.4
80 mm	PHX	43,21	1	3858-80-1.6-PHX-1.4/2

Sandflex® Top Fabricator



3853 Sandflex® Top Fabricator

		€		
20 mm	PF	10,04	1	3853-20-0.9-5/7-VS
20 mm	PF	10,04	1	3853-20-0.9-8/11-VS
27 mm	PF	10,43	1	3853-27-0.9-3/4
27 mm	PF	10,43	1	3853-27-0.9-4/6
27 mm	PF	10,43	1	3853-27-0.9-5/8
27 mm	PF	10,43	1	3853-27-0.9-8/11-VS
34 mm	PF	12,91	1	3853-34-1.1-2/3
34 mm	PF	12,91	1	3853-34-1.1-3/4
34 mm	PF	12,91	1	3853-34-1.1-4/6
34 mm	PF	12,91	1	3853-34-1.1-5/8
34 mm	PF	12,91	1	3853-34-1.1-5/7-VS
34 mm	PF	12,91	1	3853-34-1.1-8/11-VS
41 mm	PF	20,00	1	3853-41-1.3-2/3
41 mm	PF-W	20,00	1	3853-41-1.3-2/3-W
41 mm	PF	20,00	1	3853-41-1.3-3/4
41 mm	PF-W	20,00	1	3853-41-1.3-3/4-W
41 mm	PF	20,00	1	3853-41-1.3-4/6
41 mm	PF	20,00	1	3853-41-1.3-5/8
41 mm	PF	20,00	1	3853-41-1.3-5/7-VS
54 mm	PF	24,56	1	3853-54-1.3-3/4
54 mm	PF	24,56	1	3853-54-1.3-3/4-W
54 mm	PF	24,56	1	3853-54-1.3-5/8
54 mm	PF	24,56	1	3853-54-1.6-2/3
54 mm	PF-W	24,56	1	3853-54-1.6-2/3-W
54 mm	PF	24,56	1	3853-54-1.6-3/4
54 mm	PF-W	24,56	1	3853-54-1.6-3/4-W
54 mm	PF	24,56	1	3853-54-1.6-4/6
67 mm	PF	34,90	1	3853-67-1.6-2/3
67 mm	PF-W	34,90	1	3853-67-1.6-2/3-W
67 mm	PF	34,90	1	3853-67-1.6-3/4
67 mm	PF-W	34,90	1	3853-67-1.6-3/4-W
67 mm	PF-W	34,90	1	3853-67-1.6-5/8-W

Hoja de sierra Sandflex™ Top Fabricator



3853 Sandflex® Top Fabricator Coated

		€		
41 mm	PF	51,85	1	3853-41-1.3-2/3-WS
41 mm	PF	48,87	1	3853-41-1.3-3/4-WS
54 mm	PF	57,14	1	3853-54-1.6-2/3-WS
54 mm	PF	53,47	1	3853-54-1.6-3/4-WS
67 mm	PF	63,70	1	3853-67-1.6-2/3-WS
67 mm	PF	62,01	1	3853-67-1.6-3/4-WS

SIERRAS DE CINTA TRIMETÁLICAS PARA EL CORTE DE METAL

Hojas de sierra de cinta de metal duro Extreme Easy-Cut

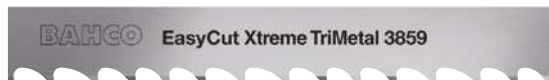

3859 Carbide Easy-Cut EZX

		€		
27 mm	EZX	32,14	1	3859-27-0.9-EZX-3/4
27 mm	EZX	42,02	1	3859-27-0.9-EZX-4/6
34 mm	EZX	31,72	1	3859-34-1.1-EZX-2/3
34 mm	EZX	40,38	1	3859-34-1.1-EZX-3/4
34 mm	EZX	43,67	1	3859-34-1.1-EZX-4/6
41 mm	EZX	30,39	1	3859-41-1.3-EZX-1.4/2
41 mm	EZX	34,30	1	3859-41-1.3-EZX-2/3
41 mm	EZX	44,19	1	3859-41-1.3-EZX-3/4
41 mm	EZX	46,25	1	3859-41-1.3-EZX-4/6
54 mm	EZX	43,16	1	3859-54-1.6-EZX-1.4/2
54 mm	EZX	39,24	1	3859-54-1.6-EZX-1/1.25
54 mm	EZX	44,70	1	3859-54-1.6-EZX-2/3
54 mm	EZX	48,00	1	3859-54-1.6-EZX-3/4
54 mm	EZX	56,75	1	3859-54-1.6-EZX-4/6
67 mm	EZX	39,45	1	3859-67-1.6-EZX-7/1
67 mm	EZX	46,66	1	3859-67-1.6-EZX-1.4/2
67 mm	EZX	42,75	1	3859-67-1.6-EZX-1/1.25
67 mm	EZX	57,17	1	3859-67-1.6-EZX-2/3
80 mm	EZX	41,51	1	3859-80-1.6-EZX-7/1
80 mm	EZX	49,23	1	3859-80-1.6-EZX-1.4/2
80 mm	EZX	77,25	1	3859-80-1.6-EZX-1/1.25

SIERRAS DE CINTA DE METAL DURO PARA METAL

Carbide Triple Set



3869 Carbide Triple Set®

		€		
13 mm	TS	53,99	1	3869-13-0.9-TS-3
20 mm	TS	55,83	1	3869-20-0.9-TS-3
20 mm	TS	81,45	1	3869-20-0.9-TS-4
27 mm	TS	55,83	1	3869-27-0.9-TS-3
27 mm	TS	81,45	1	3869-27-0.9-TS-4
34 mm	TS	35,27	1	3869-34-1.1-TS-2
34 mm	TS	59,49	1	3869-34-1.1-TS-3

Carbide Triple Set® "Xtra"™



3868 Carbide Triple Set® TSX

		€		
27 mm	TSX	87,49	1	3868-27-0.9-TSX-3/4
34 mm	TSX	57,33	1	3868-34-1.1-TSX-2
34 mm	TSX	69,82	1	3868-34-1.1-TSX-2/3
34 mm	TSX	86,09	1	3868-34-1.1-TSX-3/4
41 mm	TSX	70,50	1	3868-41-1.3-TSX-1.4/2
41 mm	TSX	61,27	1	3868-41-1.3-TSX-1.6
41 mm	TSX	60,20	1	3868-41-1.3-TSX-2
41 mm	TSX	74,87	1	3868-41-1.3-TSX-2/3
41 mm	TSX	92,13	1	3868-41-1.3-TSX-3/4
54 mm	TSX	91,48	1	3868-54-1.3-TSX-1.4/2
54 mm	TSX	93,01	1	3868-54-1.3-TSX-2/3
54 mm	TSX	93,16	1	3868-54-1.6-TSX-1/1.25
54 mm	TSX	101,86	1	3868-54-1.6-TSX-1.4/2
54 mm	TSX	88,57	1	3868-54-1.6-TSX-1.6
54 mm	TSX	93,28	1	3868-54-1.6-TSX-2/3
54 mm	TSX	93,28	1	3868-54-1.6-TSX-3/4
67 mm	TSX	122,43	1	3868-67-1.6-TSX-7/1
67 mm	TSX	127,43	1	3868-67-1.6-TSX-1/1.25
67 mm	TSX	130,30	1	3868-67-1.6-TSX-1.4/2
67 mm	TSX	130,30	1	3868-67-1.6-TSX-2/3
80 mm	TSX	205,05	1	3868-80-1.1-TSX-3/4
80 mm	TSX	130,30	1	3868-80-1.6-TSX-7/1
80 mm	TSX	139,15	1	3868-80-1.6-TSX-1/1.25
80 mm	TSX	129,40	1	3868-80-1.6-TSX-1.4/2
80 mm	TSX	180,64	1	3868-80-1.6-TSX-2/3

Carbide TSS Triple Set



3868 Carbide Triple Set® TSS

		€		
27 mm	TSS	87,49	1	3868-27-0.9-TSS-3/4
34 mm	TSS	71,21	1	3868-34-1.1-TSS-2/3
34 mm	TSS	8,81	1	3868-34-1.1-TSS-3/4
41 mm	TSS	77,62	1	3868-41-1.3-TSS-1.4/2
41 mm	TSS	76,80	1	3868-41-1.3-TSS-2/3
54 mm	TSS	113,99	1	3868-54-1.6-TSS-1/1.25
54 mm	TSS	111,95	1	3868-54-1.6-TSS-1.4/2
54 mm	TSS	118,10	1	3868-54-1.6-TSS-2/3
67 mm	TSS	122,43	1	3868-67-1.6-TSS-7/1
67 mm	TSS	130,30	1	3868-67-1.6-TSS-1/1.25
67 mm	TSS	130,30	1	3868-67-1.6-TSS-1.4/2
67 mm	TSS	130,30	1	3868-67-1.6-TSS-2/3
80 mm	TSS	130,30	1	3868-80-1.6-TSS-7/1
80 mm	TSS	156,23	1	3868-80-1.6-TSS-1.4/2
80 mm	TSS	180,64	1	3868-80-1.6-TSS-2/3



3881 Carbide Multi Chip THQ



3881 Carbide Multi Set THQ

		€		
34 mm	THQ	80,12	1	3881-34-1.1-THQ-2/3
41 mm	THQ	81,17	1	3881-41-1.3-THQ-1.4/2
41 mm	THQ	86,09	1	3881-41-1.3-THQ-2/3
54 mm	THQ	107,24	1	3881-54-1.6-THQ-1.4/2
54 mm	THQ	107,37	1	3881-54-1.6-THQ-1/1.25
54 mm	THQ	107,26	1	3881-54-1.6-THQ-2/3
67 mm	THQ	133,53	1	3881-67-1.6-THQ-1/1.25
67 mm	THQ	133,53	1	3881-67-1.6-THQ-1.4/2
67 mm	THQ	83,20	1	3881-67-1.6-THQ-2/3
80 mm	THQ	139,15	1	3881-80-1.6-THQ-7/1
80 mm	THQ	145,67	1	3881-80-1.6-THQ-1/1.25
80 mm	THQ	139,15	1	3881-80-1.6-THQ-1.4/2
80 mm	THQ	192,85	1	3881-80-1.6-THQ-2/3

3881 Carbide Multi Chip THS



3881 Carbide Multi Set THS

		€		
41 mm	THS	89,27	1	3881-41-1.3-THS-1.4/2
54 mm	THS	117,95	1	3881-54-1.6-THS-1/1.25
54 mm	THS	117,95	1	3881-54-1.6-THS-1.4/2
67 mm	THS	145,67	1	3881-67-1.6-THS-1/1.25
67 mm	THS	145,67	1	3881-67-1.6-THS-1.4/2
67 mm	THS	146,23	1	3881-67-1.6-THS-2/3
80 mm	THS	151,36	1	3881-80-1.6-THS-7/1
80 mm	THS	151,36	1	3881-80-1.6-THS-1.4/2
80 mm	THS	192,85	1	3881-80-1.6-THS-2/3
100 mm	THS	75,80	1	3881-100-1.6-THS-7/1

Sierra cinta 3860 Carbide dentado especial para Titanio



3860 Unset Carbide TMC

		€		
41 mm	TMC	97,11	1	3860-41-1.3-TMC-1.4/2
41 mm	TMC	113,62	1	3860-41-1.3-TMC-2/3
54 mm	TMC	114,97	1	3860-54-1.3-TMC-1.4/2

		€		
54 mm	TMC	133,05	1	3860-54-1.3-TMC-2/3
54 mm	TMC	90,00	1	3860-54-1.6-TMC-7/1
54 mm	TMC	114,11	1	3860-54-1.6-TMC-1/1.25
54 mm	TMC	106,82	1	3860-54-1.6-TMC-1.4/2
54 mm	TMC	146,66	1	3860-54-1.6-TMC-2/3
67 mm	TMC	126,24	1	3860-67-1.6-TMC-1/1.25
67 mm	TMC	121,39	1	3860-67-1.6-TMC-1.4/2
67 mm	TMC	149,72	1	3860-67-1.6-TMC-2/3
80 mm	TMC	113,27	1	3860-80-1.1-TMC-1.4/2
80 mm	TMC	135,96	1	3860-80-1.6-TMC-7/1
80 mm	TMC	142,62	1	3860-80-1.6-TMC-1/1.25
80 mm	TMC	149,31	1	3860-80-1.6-TMC-1.4/2
80 mm	TMC	151,11	1	3860-80-1.6-TMC-2/3
100 mm	TMC	116,93	1	3860-100-1.1-TMC-1.4/2

3860 TCD - Sierra cinta Metal Duro sin triscado



3860 Unset Carbide TCD

		€		
27 mm	TCD	96,46	1	3860-27-0.9-TCD-3
27 mm	TCD	91,44	1	3860-27-0.9-TCD-3/4
34 mm	TCD	70,73	1	3860-34-1.1-TCD-2/3
34 mm	TCD	100,96	1	3860-34-1.1-TCD-3/4
34 mm	TCD	100,96	1	3860-34-1.1-TCD-3/4-W
41 mm	TCD	63,92	1	3860-41-1.3-TCD-1.4/2
41 mm	TCD	68,50	1	3860-41-1.3-TCD-1.9/2.1
41 mm	TCD	71,35	1	3860-41-1.3-TCD-2/3
41 mm	TCD	106,61	1	3860-41-1.3-TCD-3/4
54 mm	TCD	81,39	1	3860-54-1.6-TCD-1.4/2
54 mm	TCD	66,41	1	3860-54-1.6-TCD-1.9/2.1
54 mm	TCD	97,71	1	3860-54-1.6-TCD-2/3
54 mm	TCD	135,68	1	3860-54-1.6-TCD-3/4
67 mm	TCD	87,03	1	3860-67-1.6-TCD-1.4/2
67 mm	TCD	61,43	1	3860-67-1.6-TCD-1/1.25
80 mm	TCD	93,86	1	3860-80-1.6-TCD-5/0.8

3860 TCZ - Sierra cinta metal duro sin triscado



3860 Unset Carbide TCZ

		€		
27 mm	TCZ	89,46	1	3860-27-0.9-TCZ-3/4
34 mm	TCZ	70,76	1	3860-34-1.1-TCZ-2/3
34 mm	TCZ	100,95	1	3860-34-1.1-TCZ-3/4
41 mm	TCZ	69,66	1	3860-41-1.3-TCZ-2/3
41 mm	TCZ	106,61	1	3860-41-1.3-TCZ-3/4

Dentado especial para corte barras tratadas al cromo duro

Hojas se sierra recubiertas



3860 Unset Carbide TMC Coated

W	V	€	Icon 1	Icon 2	Code
54 mm	TMC	115,28	1		3860-54-1.6-TMC-1/1.25S
54 mm	TMC	118,67	1		3860-54-1.6-TMC-1.4/2S
54 mm	TMC	129,97	1		3860-54-1.6-TMC-2/3S
67 mm	TMC	124,32	1		3860-67-1.6-TMC-1/1.25S
67 mm	TMC	129,97	1		3860-67-1.6-TMC-1.4/2S

HOJA DE SIERRA PARA MADERA

Sandcut® Bi-Metal



3861 Sandcut Bi-metal

W	V	€	Icon 1	Icon 2	Code
4	Hook	2,88	1		3861-20-0.6-H-4
1.33	Hook	3,83	1		3861-27-0.9-H-1.33
1.15	Hook	8,72	1		3861-34-0.9-H-1.15
1.15	Hook	8,72	1		3861-34-1.1-H-1.15
1.15	Hook	11,57	1		3861-41-1.1-H-1.15
1.15	Hook	13,08	1		3861-54-1.1-H-1.15

Sandcut® Sólido



3862 Sandcut Solid

W	V	€	Icon 1	Icon 2	Code
1.15	Hook	14,12	1		3862-33-0.9-H-1.15
1.15	Hook	14,12	1		3862-33-1.1-H-1.15
1.15	Hook	15,09	1		3862-40-1.1-H-1.15

SIERRAS DE CINTA PARA CORTE DE AISLAMIENTO

Hojas de sierra de cinta Sandflex® con doble punta aislante



3852 Sandflex® Twin Tip Insulation

W	V	€	Icon 1	Icon 2	Code
27 mm	INS	13,39	1		3852-27-0.9-INS-3
34 mm	INS	14,42	1		3852-34-1.1-INS-3

SIERRAS CIRCULARES DE ACERO RÁPIDO

Sierra circular acero rápido



3815-32-1

Ø	V	€	Icon 1	Icon 2	Code
200 mm	BW3	82,95	1		3815-200-2,0-32-1-03BW
200 mm	BW4	103,69	1		3815-200-2,0-32-1-04BW
225 mm	BW3	125,59	1		3815-225-2,0-32-1-03BW
225 mm	BW4	125,59	1		3815-225-2,0-32-1-04BW
225 mm	BW5	125,59	1		3815-225-2,0-32-1-05BW
225 mm	C6	125,59	1		3815-225-2,0-32-1-06C
250 mm	BW3	137,78	1		3815-250-2,0-32-1-03BW
250 mm	BW4	137,78	1		3815-250-2,0-32-1-04BW
250 mm	BW5	137,78	1		3815-250-2,0-32-1-05BW
250 mm	C6	137,78	1		3815-250-2,0-32-1-06C
275 mm	BW4	190,83	1		3815-275-2,5-32-1-04BW
275 mm	BW5	190,83	1		3815-275-2,5-32-1-05BW
275 mm	C6	190,83	1		3815-275-2,5-32-1-06C
275 mm	C8	190,83	1		3815-275-2,5-32-1-08C
300 mm	BW4	235,28	1		3815-300-2,5-32-1-04BW
300 mm	BW5	235,28	1		3815-300-2,5-32-1-05BW
300 mm	C5	235,28	1		3815-300-2,5-32-1-05C
300 mm	C6	235,28	1		3815-300-2,5-32-1-06C
300 mm	C8	235,28	1		3815-300-2,5-32-1-08C
315 mm	BW4	283,90	1		3815-315-2,5-32-1-04BW
315 mm	BW5	283,90	1		3815-315-2,5-32-1-05BW
315 mm	C6	283,90	1		3815-315-2,5-32-1-06C
315 mm	C8	283,90	1		3815-315-2,5-32-1-08C
350 mm	BW4	397,76	1		3815-350-2,5-32-1-04BW
350 mm	C6	397,76	1		3815-350-2,5-32-1-06C



Sierra circular en acero rápido



3815-40-2

Ø	V	€		
250 mm	BW3	137,78	1	3815-250-2.0-40-2-03BW
250 mm	BW4	137,78	1	3815-250-2.0-40-2-04BW
250 mm	BW5	137,78	1	3815-250-2.0-40-2-05BW
275 mm	BW3	190,83	1	3815-275-2.5-40-2-03BW
275 mm	BW4	190,83	1	3815-275-2.5-40-2-04BW
275 mm	BW5	190,83	1	3815-275-2.5-40-2-05BW
275 mm	C6	190,83	1	3815-275-2.5-40-2-06C
275 mm	C8	190,83	1	3815-275-2.5-40-2-08C
315 mm	BW4	283,90	1	3815-315-2.5-40-2-04BW
315 mm	BW5	283,90	1	3815-315-2.5-40-2-05BW
315 mm	C6	302,96	1	3815-315-3.0-40-2-06C

Sierra circular en acero rápido



3815-50-4

Ø	V	€		
370 mm	C8	397,76	1	3815-370-3.0-50-4-08C
370 mm	C10	397,76	1	3815-370-3.0-50-4-10C
400 mm	C10	522,87	1	3815-400-3.5-50-4-10C

HOJAS DE SIERRA DE MÁQUINA

Hoja de sierra para máquinas Sandflex® Bi-metal



3809

Ø	L	€		
10	300 mm	10,71	10	3809-300-25-1.25-10
14	300 mm	10,77	10	3809-300-25-1.25-14
6	300 mm	15,32	10	3809-300-32-1.60-6

Ø	L	€		
10	300 mm	15,44	10	3809-300-32-1.60-10
6	350 mm	12,50	10	3809-350-25-1.25-6
10	350 mm	12,50	10	3809-350-25-1.25-10
14	350 mm	12,50	10	3809-350-25-1.25-14
4	350 mm	16,48	10	3809-350-32-1.60-4
6	350 mm	16,48	10	3809-350-32-1.60-6
8	350 mm	16,48	10	3809-350-32-1.60-8
10	350 mm	16,48	10	3809-350-32-1.60-10
14	350 mm	16,48	10	3809-350-32-1.60-14
4	350 mm	22,08	10	3809-350-32-2.00-4
6	350 mm	22,08	10	3809-350-32-2.00-6
10	350 mm	22,08	10	3809-350-32-2.00-10
6	350 mm	27,66	10	3809-350-38-2.00-6
10	350 mm	27,66	10	3809-350-38-2.00-10
10	400 mm	15,91	10	3809-400-25-1.25-10
4	400 mm	20,94	10	3809-400-32-1.60-4
6	400 mm	20,94	10	3809-400-32-1.60-6
8	400 mm	20,94	10	3809-400-32-1.60-8
10	400 mm	20,94	10	3809-400-32-1.60-10
14	400 mm	20,94	10	3809-400-32-1.60-14
4	400 mm	24,56	10	3809-400-32-2.00-4
6	400 mm	24,56	10	3809-400-32-2.00-6
8	400 mm	25,05	10	3809-400-32-2.00-8
10	400 mm	24,56	10	3809-400-32-2.00-10
4	400 mm	28,00	10	3809-400-38-2.00-4
6	400 mm	28,00	10	3809-400-38-2.00-6
10	400 mm	28,00	10	3809-400-38-2.00-10
6	425 mm	24,73	10	3809-425-32-1.60-6
10	425 mm	28,00	10	3809-425-32-1.60-10
4	450 mm	26,16	10	3809-450-32-1.60-4
6	450 mm	26,16	10	3809-450-32-1.60-6
10	450 mm	26,16	10	3809-450-32-1.60-10
14	450 mm	26,16	10	3809-450-32-1.60-14
4	450 mm	30,83	10	3809-450-32-2.00-4
6	450 mm	30,83	10	3809-450-32-2.00-6
10	450 mm	30,83	10	3809-450-32-2.00-10
4	450 mm	35,06	10	3809-450-38-2.00-4
6	450 mm	35,06	10	3809-450-38-2.00-6
8	450 mm	35,06	10	3809-450-38-2.00-8
10	450 mm	35,06	10	3809-450-38-2.00-10
4	450 mm	43,92	10	3809-450-45-2.25-4
6	450 mm	43,92	10	3809-450-45-2.25-6
6	475 mm	50,75	10	3809-475-45-2.25-6
4	500 mm	40,96	10	3809-500-38-2.00-4
6	500 mm	40,96	10	3809-500-38-2.00-6
10	500 mm	40,96	10	3809-500-38-2.00-10
4	500 mm	52,47	10	3809-500-45-2.25-4
6	500 mm	52,47	10	3809-500-45-2.25-6
4	500 mm	62,01	10	3809-500-50-2.50-4
6	500 mm	62,01	10	3809-500-50-2.50-6
8	500 mm	62,93	10	3809-500-50-2.50-8
6	525 mm	42,81	10	3809-525-38-2.00-6
10	525 mm	42,81	10	3809-525-38-2.00-10
4	525 mm	54,85	10	3809-525-45-2.25-4
6	525 mm	54,85	10	3809-525-45-2.25-6
4	550 mm	57,69	10	3809-550-45-2.25-4
6	550 mm	57,69	10	3809-550-45-2.25-6
4	550 mm	68,75	10	3809-550-50-2.50-4
6	550 mm	68,75	10	3809-550-50-2.50-6
4	575 mm	62,84	10	3809-575-45-2.25-4
3	575 mm	71,69	10	3809-575-50-2.50-3
4	575 mm	71,69	10	3809-575-50-2.50-4
6	575 mm	71,69	10	3809-575-50-2.50-6
6	600 mm	50,96	10	3809-600-38-2.00-6
4	600 mm	63,05	10	3809-600-45-2.25-4
6	600 mm	63,05	10	3809-600-45-2.25-6
3	600 mm	76,25	10	3809-600-50-2.50-3
4	600 mm	76,25	10	3809-600-50-2.50-4
6	600 mm	76,25	10	3809-600-50-2.50-6
4	650 mm	84,90	5	3809-650-50-2.50-4
6	650 mm	84,90	5	3809-650-50-2.50-6
4	700 mm	92,76	5	3809-700-50-2.50-4
6	700 mm	92,76	5	3809-700-50-2.50-6
4	750 mm	108,25	5	3809-750-50-2.50-4
6	750 mm	108,25	5	3809-750-50-2.50-6

Sandflex® Bi-metal hoja de sierra para máquina KASTO

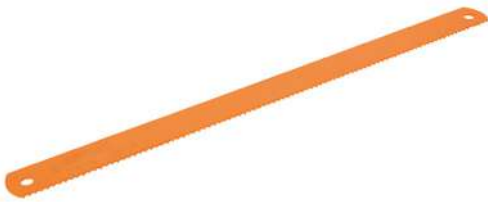

3809 KA

		€		
6	400 mm	24,59	10	3809-400-32-2.00-6-KA
4	450 mm	35,06	10	3809-450-38-2.00-4-KA
6	450 mm	35,06	10	3809-450-38-2.00-6-KA
10	450 mm	35,06	10	3809-450-38-2.00-10-KA
6	500 mm	52,47	10	3809-500-45-2.25-6-KA
4	500 mm	62,01	10	3809-500-50-2.50-4-KA
6	500 mm	62,01	10	3809-500-50-2.50-6-KA
4	550 mm	68,75	10	3809-550-50-2.50-4-KA
6	550 mm	68,75	10	3809-550-50-2.50-6-KA
3	575 mm	71,69	10	3809-575-50-2.50-3-KA
4	575 mm	71,69	10	3809-575-50-2.50-4-KA
6	575 mm	71,69	10	3809-575-50-2.50-6-KA
10	575 mm	71,69	10	3809-575-50-2.50-10-KA
4	600 mm	76,25	10	3809-600-50-2.50-4-KA
6	600 mm	76,25	10	3809-600-50-2.50-6-KA
3	650 mm	84,90	5	3809-650-50-2.50-3-KA
4	650 mm	84,90	5	3809-650-50-2.50-4-KA
6	650 mm	84,90	5	3809-650-50-2.50-6-KA
3	700 mm	92,76	5	3809-700-50-2.50-3-KA
4	700 mm	92,76	5	3809-700-50-2.50-4-KA
6	700 mm	92,76	5	3809-700-50-2.50-6-KA

Hoja de sierra para máquinas HSS

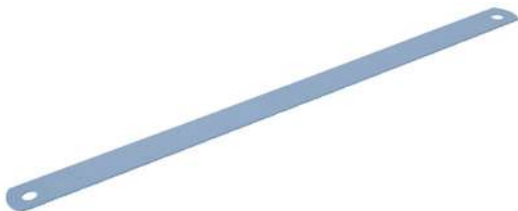

3802

		€		
6	300 mm	11,89	10	3802-300-25-1.25-6
10	300 mm	11,89	10	3802-300-25-1.25-10
14	300 mm	11,94	10	3802-300-25-1.25-14
6	300 mm	17,15	10	3802-300-32-1.60-6
10	300 mm	17,40	10	3802-300-32-1.60-10
6	350 mm	13,97	10	3802-350-25-1.25-6
10	350 mm	13,97	10	3802-350-25-1.25-10
14	350 mm	13,97	10	3802-350-25-1.25-14
4	350 mm	18,42	10	3802-350-32-1.60-4
6	350 mm	18,42	10	3802-350-32-1.60-6
8	350 mm	18,42	10	3802-350-32-1.60-8
10	350 mm	18,42	10	3802-350-32-1.60-10
14	350 mm	18,42	10	3802-350-32-1.60-14
6	400 mm	17,81	10	3802-400-25-1.25-6
10	400 mm	17,81	10	3802-400-25-1.25-10
14	400 mm	17,81	10	3802-400-25-1.25-14
4	400 mm	23,25	10	3802-400-32-1.60-4
6	400 mm	23,25	10	3802-400-32-1.60-6
8	400 mm	23,25	10	3802-400-32-1.60-8
10	400 mm	23,25	10	3802-400-32-1.60-10
14	400 mm	23,25	10	3802-400-32-1.60-14
4	400 mm	31,05	10	3802-400-38-2.00-4

		€		
6	400 mm	31,05	10	3802-400-38-2.00-6
10	400 mm	31,05	10	3802-400-38-2.00-10
6	425 mm	27,59	10	3802-425-32-1.60-6
10	425 mm	28,08	10	3802-425-32-1.60-10
4	450 mm	29,06	10	3802-450-32-1.60-4
6	450 mm	29,06	10	3802-450-32-1.60-6
10	450 mm	29,06	10	3802-450-32-1.60-10
14	450 mm	29,06	10	3802-450-32-1.60-14
4	450 mm	38,98	10	3802-450-38-2.00-4
6	450 mm	38,98	10	3802-450-38-2.00-6
8	450 mm	38,98	10	3802-450-38-2.00-8
10	450 mm	38,98	10	3802-450-38-2.00-10
8	475 mm	41,71	10	3802-475-38-2.00-8
4	500 mm	45,78	10	3802-500-38-2.00-4
6	500 mm	45,78	10	3802-500-38-2.00-6
8	500 mm	45,78	10	3802-500-38-2.00-8
10	500 mm	45,78	10	3802-500-38-2.00-10
10	500 mm	64,49	10	3802-500-45-2.25-10
4	500 mm	69,05	10	3802-500-50-2.50-4
6	500 mm	69,05	10	3802-500-50-2.50-6
6	525 mm	47,63	10	3802-525-38-2.00-6
8	525 mm	42,64	10	3802-525-38-2.00-8
10	525 mm	48,09	10	3802-525-38-2.00-10
6	550 mm	44,81	10	3802-550-38-2.00-6
4	550 mm	75,93	10	3802-550-50-2.50-4
6	550 mm	76,31	10	3802-550-50-2.50-6
8	550 mm	77,84	5	3802-550-50-2.50-8
10	550 mm	77,84	10	3802-550-50-2.50-10
4	575 mm	79,78	10	3802-575-50-2.50-4
6	575 mm	79,78	10	3802-575-50-2.50-6
4	600 mm	84,98	10	3802-600-50-2.50-4
6	600 mm	84,98	10	3802-600-50-2.50-6
8	600 mm	84,98	10	3802-600-50-2.50-8
4	650 mm	94,50	5	3802-650-50-2.50-4
6	650 mm	94,50	5	3802-650-50-2.50-6
3	700 mm	90,79	5	3802-700-50-2.50-3
4	700 mm	103,30	5	3802-700-50-2.50-4
6	700 mm	103,30	5	3802-700-50-2.50-6
4	750 mm	120,49	5	3802-750-50-2.50-4
6	750 mm	110,04	5	3802-750-50-2.50-6

Hoja de sierra para máquinas KASTO HSS

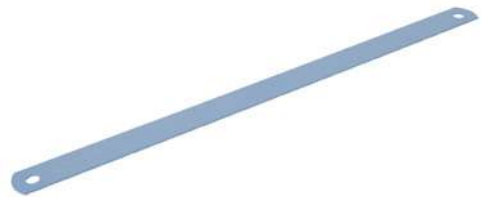

3802 KA

		€		
4	450 mm	38,98	10	3802-450-38-2.00-4-KA
6	450 mm	38,98	10	3802-450-38-2.00-6-KA
8	450 mm	38,98	10	3802-450-38-2.00-8-KA
10	450 mm	38,98	10	3802-450-38-2.00-10-KA
4	500 mm	69,05	10	3802-500-50-2.50-4-KA
6	500 mm	69,05	10	3802-500-50-2.50-6-KA
4	550 mm	76,31	10	3802-550-50-2.50-4-KA
8	550 mm	76,31	10	3802-550-50-2.50-8-KA
3	575 mm	79,78	10	3802-575-50-2.50-3-KA
4	575 mm	79,78	10	3802-575-50-2.50-4-KA
6	575 mm	79,78	10	3802-575-50-2.50-6-KA
4	650 mm	94,50	5	3802-650-50-2.50-4-KA
6	650 mm	86,26	5	3802-650-50-2.50-6-KA
2	700 mm	102,87	5	3802-700-50-2.50-2-KA
4	700 mm	103,30	5	3802-700-50-2.50-4-KA
6	700 mm	103,30	5	3802-700-50-2.50-6-KA



ACCESORIOS PARA SIERRAS DE CINTA

Cepillo de virutas



3870-BRUSH

Ø	€	Icon	Icon
60 mm	22,42	4	3870-BRUSH-60-6
80 mm	26,00	4	3870-BRUSH-80-6
80 mm	26,00	4	3870-BRUSH-80-8
80 mm	26,00	4	3870-BRUSH-80-10
100 mm	33,28	4	3870-BRUSH-100-10
100 mm	24,62	4	3870-BRUSH-100-12
100 mm	33,28	4	3870-BRUSH-100-10-HEX
100 mm	33,28	1	3870-BRUSH-100-13

Tacómetro



3870-TACHO

g	€	Icon	Icon
400 g	430,62	1	3870-TACHO METER

Tensiómetro



3870-TENSION

g	€	Icon	Icon
680 g	288,66	1	3870-TENSION METER

Refractómetro



3870-REFR

g	€	Icon	Icon
260 g	71,53	1	3870-REFRACTOMETER

Cuña metálica larga, 75mm



3870-WEDGE

g	€	Icon	Icon
60 g	4,52	1	3870-WEDGE-3

Rueda para ajuste de tensión de sierra cinta



3870-Wheel

kg	€	Icon	Icon
0.7790 kg	61,03	1	3870-WHEEL



Limas



LIMAS DE MECÁNICO

Lima plana paralela, embalaje industrial, sin mango



1-100...-0

		€		
100 mm	1	5,50	10	1-100-04-1-0
100 mm	2	4,93	10	1-100-04-2-0
100 mm	3	5,13	10	1-100-04-3-0
150 mm	1	5,13	10	1-100-06-1-0
150 mm	2	5,48	10	1-100-06-2-0
150 mm	3	5,68	10	1-100-06-3-0
200 mm	1	6,64	10	1-100-08-1-0
200 mm	2	7,05	10	1-100-08-2-0
200 mm	3	7,16	10	1-100-08-3-0
250 mm	1	8,67	10	1-100-10-1-0
250 mm	2	9,07	10	1-100-10-2-0
250 mm	3	9,21	10	1-100-10-3-0
300 mm	1	11,84	5	1-100-12-1-0
300 mm	2	12,11	5	1-100-12-2-0
300 mm	3	12,25	5	1-100-12-3-0
350 mm	1	16,93	5	1-100-14-1-0
350 mm	2	17,73	5	1-100-14-2-0

Tipo de picado: 1 = Basto, 2 = Entrefino, 3 = Fino

Lima paralela con mango



ergo



1-100...-2

		€		
100 mm	1	6,91	5	1-100-04-1-2
100 mm	2	7,05	5	1-100-04-2-2
150 mm	1	8,73	5	1-100-06-1-2
150 mm	2	8,81	5	1-100-06-2-2
150 mm	3	8,80	5	1-100-06-3-2
200 mm	1	9,55	5	1-100-08-1-2
200 mm	2	10,01	5	1-100-08-2-2
200 mm	3	11,13	5	1-100-08-3-2
250 mm	1	12,33	5	1-100-10-1-2
250 mm	2	12,72	5	1-100-10-2-2
250 mm	3	12,07	5	1-100-10-3-2
300 mm	1	15,21	5	1-100-12-1-2
300 mm	2	15,48	5	1-100-12-2-2
300 mm	3	14,23	5	1-100-12-3-2

Tipo de picado: 1 = Basto, 2 = Entrefino, 3 = Fino

Lima plana paralela, delgada



1-102

		€		
150 mm	2	7,72	10	1-102-06-2-0
150 mm	3	8,13	10	1-102-06-3-0
200 mm	1	9,21	10	1-102-08-1-0
200 mm	2	9,55	10	1-102-08-2-0
200 mm	3	9,67	10	1-102-08-3-0

Lima para torneear



1-104

		€		
250 mm	2	14,89	10	1-104-10-2-0
250 mm	3	15,42	10	1-104-10-3-0
300 mm	2	19,91	5	1-104-12-2-0
300 mm	3	21,39	5	1-104-12-3-0
350 mm	3	28,96	5	1-104-14-3-0

Tipo de picado: 2 = Entrefino, 3 = Fino

Lima plana paralela "Oberberg Cut"



1-106...-0

		€		
200 mm	1	10,90	10	1-106-08-1-0
250 mm	1	15,17	10	1-106-10-1-0
300 mm	1	19,37	5	1-106-12-1-0

Limado Oberg



ergo



1-106...-2

		€		
200 mm	1	14,31	5	1-106-08-1-2
250 mm	1	18,32	5	1-106-10-1-2
300 mm	1	22,11	5	1-106-12-1-2

Lima plana



1-110...-0

		€		
100 mm	1	4,69	10	1-110-04-1-0
100 mm	2	4,93	10	1-110-04-2-0
100 mm	2	5,13	10	1-110-04-3-0
150 mm	1	5,13	10	1-110-06-1-0
150 mm	2	5,48	10	1-110-06-2-0
150 mm	3	5,68	10	1-110-06-3-0
200 mm	1	6,64	10	1-110-08-1-0
200 mm	2	7,05	10	1-110-08-2-0
200 mm	2	7,16	10	1-110-08-3-0
250 mm	1	8,67	10	1-110-10-1-0
250 mm	2	9,07	10	1-110-10-2-0
250 mm	3	9,21	10	1-110-10-3-0
300 mm	1	11,84	5	1-110-12-1-0
300 mm	2	12,11	5	1-110-12-2-0
300 mm	3	12,25	5	1-110-12-3-0
350 mm	1	16,93	5	1-110-14-1-0

Tipo de picado: 1 = Basto, 2 = Entrefino, 3 = Fino

Lima plana



ergo



1-110...-2

			€		
150 mm	1	8,73	5	1-110-06-1-2	
150 mm	2	8,81	5	1-110-06-2-2	
150 mm	3	8,71	5	1-110-06-3-2	
200 mm	1	9,55	5	1-110-08-1-2	
200 mm	2	10,01	5	1-110-08-2-2	
200 mm	3	10,09	5	1-110-08-3-2	
250 mm	1	12,33	5	1-110-10-1-2	
250 mm	2	12,72	5	1-110-10-2-2	
250 mm	3	11,57	5	1-110-10-3-2	
300 mm	1	14,05	5	1-110-12-1-2	
300 mm	2	16,38	5	1-110-12-2-2	
300 mm	3	14,42	5	1-110-12-3-2	

Tipo de picado: 1 = Basto, 2 = Entrefino, 3 = Fino

Lima plana, punta delgada



1-111...-0

			€		
100 mm	1	5,13	10	1-111-04-1-0	
100 mm	2	5,41	10	1-111-04-2-0	
100 mm	3	5,60	10	1-111-04-3-0	
150 mm	1	5,60	10	1-111-06-1-0	
150 mm	2	6,42	10	1-111-06-2-0	
150 mm	3	6,64	10	1-111-06-3-0	
200 mm	1	7,84	10	1-111-08-1-0	
200 mm	2	8,88	10	1-111-08-2-0	

Tipo de picado: 1 = Basto, 2 = Entrefino, 3 = Fino

Lima plana, punta delgada



ergo



1-111...-2

			€		
150 mm	2	9,90	5	1-111-06-2-2	

Lima de contacto



1-115

			€		
110 mm	3	10,45	10	1-115-11-3-1	

Lima universal, 2 cantos planos (tipo USA)



1-143...-0

			€		
100 mm	1	4,25	10	1-143-04-1-0	
150 mm	1	4,62	10	1-143-06-1-0	
200 mm	1	5,96	10	1-143-08-1-0	
250 mm	1	7,84	10	1-143-10-1-0	
300 mm	1	10,70	5	1-143-12-1-0	

Lima 2 cantos planos



ergo



1-143...-2

			€		
150 mm	1	8,53	5	1-143-06-1-2	
200 mm	1	9,82	5	1-143-08-1-2	
250 mm	1	11,71	5	1-143-10-1-2	
300 mm	1	14,75	5	1-143-12-1-2	

Lima diagonal



ergo



1-320 ...-2

			€		
200 mm	2	21,45	5	1-320-08-2-2	
250 mm	2	23,41	5	1-320-10-2-2	

Lima diagonal



1-320...-0

			€		
200 mm	2	17,73	10	1-320-08-2-0	
250 mm	2	19,63	10	1-320-10-2-0	
300 mm	2	21,64	5	1-320-12-2-0	



Lima media caña



1-210...-0

			€		
100 mm	1	8,06	10	1-210-04-1-0	
100 mm	2	8,13	10	1-210-04-2-0	
100 mm	3	8,24	10	1-210-04-3-0	
150 mm	1	8,24	10	1-210-06-1-0	
150 mm	2	8,47	10	1-210-06-2-0	
150 mm	3	8,60	10	1-210-06-3-0	
200 mm	1	10,17	10	1-210-08-1-0	
200 mm	2	10,36	10	1-210-08-2-0	
200 mm	3	10,56	10	1-210-08-3-0	
250 mm	1	12,38	10	1-210-10-1-0	
250 mm	2	12,78	10	1-210-10-2-0	
250 mm	3	13,06	10	1-210-10-3-0	
300 mm	1	18,42	5	1-210-12-1-0	
300 mm	2	18,82	5	1-210-12-2-0	
300 mm	3	19,08	5	1-210-12-3-0	
350 mm	1	25,44	5	1-210-14-1-0	

Tipo de picado: 1 = Basto, 2 = Entrefino, 3 = Fino

Lima redonda



1-230...-0

			€		
100 mm	1	4,82	10	1-230-04-1-0	
100 mm	2	5,08	10	1-230-04-2-0	
100 mm	3	5,21	10	1-230-04-3-0	
150 mm	1	5,41	10	1-230-06-1-0	
150 mm	2	5,68	10	1-230-06-2-0	
150 mm	3	5,79	10	1-230-06-3-0	
200 mm	1	6,42	10	1-230-08-1-0	
200 mm	2	6,82	10	1-230-08-2-0	
200 mm	3	7,12	10	1-230-08-3-0	
250 mm	1	7,84	10	1-230-10-1-0	
250 mm	2	8,73	10	1-230-10-2-0	
250 mm	3	9,35	10	1-230-10-3-0	
300 mm	1	10,90	5	1-230-12-1-0	
300 mm	2	11,52	5	1-230-12-2-0	
300 mm	3	11,71	5	1-230-12-3-0	

Tipo de picado: 1 = Basto, 2 = Entrefino, 3 = Fino

Lima triangular



1-170...-0

			€		
100 mm	1	5,40	10	1-170-04-1-0	
100 mm	2	5,43	10	1-170-04-2-0	
100 mm	3	5,79	10	1-170-04-3-0	
150 mm	1	6,07	10	1-170-06-1-0	
150 mm	2	6,46	10	1-170-06-2-0	
150 mm	3	6,64	10	1-170-06-3-0	
200 mm	1	8,00	10	1-170-08-1-0	
200 mm	2	8,47	10	1-170-08-2-0	
200 mm	3	8,67	10	1-170-08-3-0	
250 mm	1	11,30	10	1-170-10-1-0	
250 mm	2	11,78	10	1-170-10-2-0	
250 mm	3	12,06	10	1-170-10-3-0	
300 mm	1	14,60	5	1-170-12-1-0	
300 mm	2	15,83	5	1-170-12-2-0	

Tipo de picado: 1 = Basto, 2 = Entrefino, 3 = Fino

Lima de media caña



ergo®



1-210...-2

			€		
100 mm	1	10,01	5	1-210-04-1-2	
100 mm	2	10,01	5	1-210-04-2-2	
150 mm	1	10,44	5	1-210-06-1-2	
150 mm	2	10,63	5	1-210-06-2-2	
150 mm	3	11,30	5	1-210-06-3-2	
200 mm	1	11,98	5	1-210-08-1-2	
200 mm	2	12,87	5	1-210-08-2-2	
200 mm	3	11,67	5	1-210-08-3-2	
250 mm	1	16,13	5	1-210-10-1-2	
250 mm	2	16,93	5	1-210-10-2-2	
250 mm	3	14,21	5	1-210-10-3-2	
300 mm	1	21,71	5	1-210-12-1-2	
300 mm	2	21,95	5	1-210-12-2-2	
300 mm	3	23,50	5	1-210-12-3-2	

Tipo de picado: 1 = Basto, 2 = Entrefino, 3 = Fino

Lima redonda con mango



ergo®



1-230...-2

			€		
100 mm	1	6,65	5	1-230-04-1-2	
100 mm	2	6,96	5	1-230-04-2-2	
150 mm	1	7,88	5	1-230-06-1-2	
150 mm	2	8,05	5	1-230-06-2-2	
150 mm	3	7,73	5	1-230-06-3-2	
200 mm	1	8,88	5	1-230-08-1-2	
200 mm	2	9,21	5	1-230-08-2-2	
200 mm	3	8,92	5	1-230-08-3-2	
250 mm	1	11,25	5	1-230-10-1-2	
250 mm	2	11,78	5	1-230-10-2-2	
250 mm	3	11,52	5	1-230-10-3-2	
300 mm	1	13,90	5	1-230-12-1-2	
300 mm	2	13,90	5	1-230-12-2-2	
300 mm	3	13,36	5	1-230-12-3-2	

Tipo de picado: 1-basto/ 2-entrefino/ 3-fino

Lima triangular



ergo®



1-170...-2

			€		
100 mm	2	8,73	5	1-170-04-2-2	
150 mm	1	8,97	5	1-170-06-1-2	
150 mm	2	9,44	5	1-170-06-2-2	
150 mm	3	10,72	5	1-170-06-3-2	
200 mm	1	11,30	5	1-170-08-1-2	
200 mm	2	11,71	5	1-170-08-2-2	
200 mm	3	13,92	5	1-170-08-3-2	
250 mm	1	14,57	5	1-170-10-1-2	
250 mm	2	14,60	5	1-170-10-2-2	
250 mm	3	17,76	5	1-170-10-3-2	

Tipo de picado: 1 = Basto, 2 = Entrefino, 3 = Fino

Lima cuadrada



1-160...-0

Longitud	Cant.	Precio	Paquete	Forma	Modelo
100 mm	1	5,58	10	1-160-04-1-0	
100 mm	2	5,83	10	1-160-04-2-0	
100 mm	3	5,96	10	1-160-04-3-0	
150 mm	1	5,38	10	1-160-06-1-0	
150 mm	2	5,79	10	1-160-06-2-0	
150 mm	3	6,01	10	1-160-06-3-0	
200 mm	1	6,45	10	1-160-08-1-0	
200 mm	2	6,76	10	1-160-08-2-0	
200 mm	3	6,91	10	1-160-08-3-0	
250 mm	1	9,14	10	1-160-10-1-0	
250 mm	2	9,60	10	1-160-10-2-0	
250 mm	3	9,76	10	1-160-10-3-0	
300 mm	1	13,13	5	1-160-12-1-0	
300 mm	2	13,67	5	1-160-12-2-0	
300 mm	3	16,10	5	1-160-12-3-0	

Tipo de picado: 1 = Basto, 2 = Entrefino, 3 = Fino

Lima cuadrada



1-160...-2

Longitud	Cant.	Precio	Paquete	Forma	Modelo
100 mm	1	7,88	5	1-160-04-1-2	
100 mm	2	8,24	5	1-160-04-2-2	
150 mm	1	8,67	5	1-160-06-1-2	
150 mm	2	8,73	5	1-160-06-2-2	
150 mm	3	9,13	5	1-160-06-3-2	
200 mm	1	9,76	5	1-160-08-1-2	
200 mm	2	10,17	5	1-160-08-2-2	
200 mm	3	11,67	5	1-160-08-3-2	
250 mm	1	12,06	5	1-160-10-1-2	
250 mm	2	12,87	5	1-160-10-2-2	
250 mm	3	14,21	5	1-160-10-3-2	
300 mm	1	17,37	5	1-160-12-1-2	
300 mm	2	17,02	5	1-160-12-2-2	
300 mm	3	17,17	5	1-160-12-3-2	

Tipo de picado: 1 = Basto, 2 = Entrefino, 3 = Fino

Juego 6 limas de mecánico, picado fino



1-476

Longitud	Cant.	Precio	Paquete	Forma	Modelo
100 mm	3	49,10	1	1-476-04-3-2	

Tipo de picado: 3 = Fino 1-160-04-3-2, 1-111-04-3-2, 1-230-04-3-2, 1-170-04-3-2, 1-210-04-3-2, 1-100-04-3-2

Juego de 3 limas de mecánico ERGO™



1-473

Longitud	Cant.	Precio	Paquete	Forma	Modelo
150 mm	2	28,47	5	1-473-06-2-2	

1-230-06-2-2		
1-210-06-2-2		
1-100-06-2-2		

Juego de 3 limas de mecánico ERGO™



1-473-08-2-2

Longitud	Cant.	Precio	Paquete	Forma	Modelo
200 mm	2	32,87	5	1-473-08-2-2	

1-230-08-2-2		
1-210-08-2-2		
1-100-08-2-2		

Juego de 3 limas de mecánico ERGO™



1-473-10-2-2_1

Longitud	Cant.	Precio	Paquete	Forma	Modelo
250 mm	2	38,72	5	1-473-10-2-2	

1-230-10-2-2		
1-210-10-2-2		
1-100-10-2-2		

Juego de 5 limas de mecánico ERGO™



1-477

Longitud	Cant.	Precio	Paquete	Forma	Modelo
200 mm	2	58,08	5	1-477-08-2-2	

1-100-08-2-2		
1-210-08-2-2		
6-343-08-2-2		
1-230-08-2-2		
1-170-08-2-2		



Juego de 5 limas de mecánico ERGO™



ergo



1-477-10-2-2

		€		
250 mm	2	69,77	5	1-477-10-2-2

1-100-10-2-2		
1-210-10-2-2		
6-343-10-2-2		
1-230-10-2-2		
1-170-10-2-2		

Juego de 5 limas de mecánico ERGO™



ergo



1-478

		€		
200 mm	1&2	52,63	5	1-478-08-1-2

1-210-08-1-2		
1-230-08-1-2		
1-100-08-1-2, 1-100-08-2-2		
1-160-08-1-2		

Juego de 5 limas de mecánico ERGO™



ergo



1-478-10-1-2_1

		€		
250 mm	1&2	62,64	5	1-478-10-1-2

1-210-10-1-2		
1-230-10-1-2		
1-100-10-1-2, 1-100-10-2-2		
1-160-10-1-2		

Juego de 5 limas de mecánico ERGO™



ergo



1-479

		€		
200 mm	1	61,85	5	1-479-08-1-2

4-138-08-1-2		
1-210-08-1-2		
6-343-08-2-2		
1-230-08-1-2		
1-100-08-1-2		

Juego de 5 limas de mecánico ERGO™



ergo



1-479-08-2-2

		€		
200 mm	2	62,90	5	1-479-08-2-2

4-138-08-1-2		
1-210-08-2-2		
6-343-08-2-2		
1-230-08-2-2		
1-100-08-2-2		

LIMAS PARA AFILADO

Lima para cadena de motosierra, plana



ergo



166-2

		€		
150 mm	3	8,74	5	166-6-16-2.5-2

Lima para cadena de motosierra, plana



166/167-12

		€		
150 mm	3	4,26	12	166-6-16-2.5-12
200 mm	1	7,43	12	167-8-21-3.2-12

Lima para cadena de motosierra



168 - 1P

		€		
150 mm	3.2 mm	1,75	12	168-6-3.2-1P
150 mm	3.5 mm	1,75	12	168-6-3.5-1P
200 mm	4.0 mm	1,75	12	168-8-4.0-1P
200 mm	4.5 mm	1,75	12	168-8-4.5-1P
200 mm	4.8 mm	1,75	12	168-8-4.8-1P
200 mm	5.2 mm	1,75	12	168-8-5.2-1P
200 mm	5.5 mm	1,75	12	168-8-5.5-1P
200 mm	6.3 mm	2,01	12	168-8-6.3-1P

Lima para cadena de motosierra



168 - 3P

Length	Width	Price	Quantity	Code
150 mm	3.2 mm	5,04	12	168-6-3.2-3P
150 mm	3.5 mm	5,04	12	168-6-3.5-3P
200 mm	4.0 mm	5,04	12	168-8-4.0-3P
200 mm	4.5 mm	5,04	12	168-8-4.5-3P
200 mm	4.8 mm	5,04	12	168-8-4.8-3P
200 mm	5.2 mm	5,04	12	168-8-5.2-3P
200 mm	5.5 mm	5,04	12	168-8-5.5-3P
200 mm	6.3 mm	5,04	12	168-8-6.3-3P

Lima para cadena de motosierra, caja de 6 limas



168-8

Length	Width	Price	Quantity	Code
200 mm	4.0 mm	1,71	6	168-8-4.0-6
200 mm	4.5 mm	1,71	6	168-8-4.5-6
200 mm	4.8 mm	1,71	6	168-8-4.8-6
200 mm	5.2 mm	1,72	6	168-8-5.2-6
200 mm	5.5 mm	1,71	6	168-8-5.5-6

Juego de limas para cadenas de motosierra con guía de limado



168-C-G

Length	Width	Price	Quantity	Code
200 mm	4.0 mm	29,11	10	168-COMBI-4.0-6922
200 mm	4.8 mm	29,90	10	168-COMBI-4.8-6920
200 mm	5.5 mm	29,90	10	168-COMBI-5.5-6924

Juego de limas para cadenas de motosierra



168-C

Length	Width	Price	Quantity	Code
200 mm	4.0 mm	15,02	10	168-COMBI-4.0
200 mm	4.5 mm	15,02	10	168-COMBI-4.5
200 mm	4.8 mm	15,02	10	168-COMBI-4.8
200 mm	5.5 mm	15,02	10	168-COMBI-5.5

Lima plana paralela



4-138...-0

Length	Width	Price	Quantity	Code
150 mm		7,60	10	4-138-06-1-0
200 mm		9,78	10	4-138-08-1-0
250 mm		12,04	10	4-138-10-1-0
300 mm		16,82	5	4-138-12-1-0

Lima plana paralela



4-138...-2

Length	Width	Price	Quantity	Code
150 mm		10,79	5	4-138-06-1-2
200 mm		13,01	5	4-138-08-1-2
250 mm		15,09	5	4-138-10-1-2
300 mm		19,48	5	4-138-12-1-2

Lima plana paralela



4-140...-0

Length	Width	Price	Quantity	Code
150 mm	1	7,95	10	4-140-06-1-0
200 mm	1	9,92	10	4-140-08-1-0
250 mm	1	12,18	10	4-140-10-1-0

Lima plana paralela



4-140...-2

Length	Width	Price	Quantity	Code
200 mm	1	13,01	5	4-140-08-1-2
250 mm	1	15,34	5	4-140-10-1-2

Lima plana paralela



4-142

Length	Width	Price	Quantity	Code
150 mm	1	7,33	10	4-142-06-1-0
200 mm	1	8,48	10	4-142-08-1-0
250 mm	1	11,09	10	4-142-10-1-0



Lima plana paralela



4-144...-0

Longitud	Cant.	€	Paquete	Artículo
200 mm	2	10,25	10	4-144-08-2-0

Lima de bricolaje para metal, embalaje individual



4-153

Longitud	Cant.	€	Paquete	Artículo
200 mm	1 & 1	16,44	5	4-153-08-1-2

Un lado con picado doble basto, el otro lado picado sencillo entrefino

Lima triangular para afilado



4-183...-0

Longitud	Cant.	€	Paquete	Artículo
100 mm	2	4,40	10	4-183-04-2-0
125 mm	2	5,09	10	4-183-05-2-0
150 mm	2	6,06	10	4-183-06-2-0
175 mm	2	7,19	10	4-183-07-2-0
200 mm	2	9,58	10	4-183-08-2-0
250 mm	2	11,98	10	4-183-10-2-0

Lima plana paralela



4-144...-2

Longitud	Cant.	€	Paquete	Artículo
200 mm	2	13,39	5	4-144-08-2-2

Juego de 2 limas de bricolaje 4-152 + 4-153



4-154

Longitud	Cant.	€	Paquete	Artículo
200 mm	1 & 2	31,18	10	4-154-08-2-2

Lima triangular para afilado



4-183...-2

Longitud	Cant.	€	Paquete	Artículo
100 mm	2	6,19	5	4-183-04-2-2
125 mm	2	7,59	5	4-183-05-2-2
150 mm	2	7,78	5	4-183-06-2-2
175 mm	2	9,21	5	4-183-07-2-2
200 mm	2	10,96	5	4-183-08-2-2

Lima de bricolaje para madera



4-152

Longitud	Cant.	€	Paquete	Artículo
200 mm	2 & 2	16,44	5	4-152-08-2-2

Un lado con picado doble basto, el otro lado picado sencillo entrefino

Lima para herramientas agrícolas



4-155

Longitud	Cant.	€	Paquete	Artículo
200 mm	1	12,22	10	4-155-08-2-0
250 mm	1	16,18	5	4-155-10-2-0

Lima triangular delgada



4-186...-0

Longitud	Cant.	€	Paquete	Artículo
100 mm	2	5,14	10	4-186-04-2-0
125 mm	2	5,14	10	4-186-05-2-0
150 mm	2	5,14	10	4-186-06-2-0
175 mm	2	7,27	10	4-186-07-2-0
200 mm	2	8,21	10	4-186-08-2-0

Lima triangular delgada



ergo®



4-186...-2

			€		
100 mm	2	6,59	5	4-186-04-2-2	
125 mm	2	7,32	5	4-186-05-2-2	
150 mm	2	7,78	5	4-186-06-2-2	

Lima triangular super delgada



4-188...-0

			€		
125 mm	2	7,12	10	4-188-05-2-0	
150 mm	2	7,95	10	4-188-06-2-0	

Lima triangular para sierras - 2 puntas



ergo®



4-190...-2

			€		
150 mm	2	7,80	5	4-190-06-2-2	
175 mm	2	9,38	5	4-190-07-2-2	
200 mm	2	8,66	5	4-190-08-2-2	

Lima triangular extra-delgada



4-187...-0

			€		
100 mm	2	5,43	10	4-187-04-2-0	
112 mm	2	5,86	10	4-187-45-2-0	
125 mm	2	5,86	10	4-187-05-2-0	
150 mm	2	6,20	10	4-187-06-2-0	
175 mm	2	8,83	10	4-187-07-2-0	

Lima triangular super delgada



ergo®



4-188...-2

			€		
125 mm	2	9,10	5	4-188-05-2-2	

Lima triangular para sierra de cinta



4-192...-0

			€		
150 mm	2	8,41	10	4-192-06-2-0	
175 mm	2	9,58	10	4-192-07-2-0	
200 mm	2	10,25	10	4-192-08-2-0	

Lima triangular extra-delgada



ergo®



4-187...-2

			€		
125 mm	2	7,93	5	4-187-05-2-2	
150 mm	2	9,47	5	4-187-06-2-2	

Lima triangular para sierras - 2 puntas



4-190...-0

			€		
175 mm	2	7,19	10	4-190-07-2-0	
200 mm	2	7,68	10	4-190-08-2-0	

Lima triangular para sierra de cinta



ergo®



4-192...-2

			€		
150 mm	2	11,64	5	4-192-06-2-2	
200 mm	2	13,39	5	4-192-08-2-2	



Limas para sierra de cinta



4-202 - 4-204

Longitud	Picados	€	Paquete	Artículo
216 mm	2	10,47	10	4-202-85-2-0
216 mm	2	13,35	10	4-204-85-2-0

Lima rómbica Wasa™



4-272...-0

Longitud	Picados	€	Paquete	Artículo
150 mm	3	8,48	10	4-272-06-3-0

Lima rómbica Wasa™



ergo®



4-272...-2

Longitud	Picados	€	Paquete	Artículo
125 mm	3	11,64	5	4-272-05-3-2
150 mm	3	11,64	5	4-272-06-3-2

ESCOFINAS

Escofina plana paralela



6-344...-0

Longitud	Picados	€	Paquete	Artículo
200 mm	2	10,47	10	6-344-08-2-0
250 mm	2	11,86	10	6-344-10-2-0

Tipo de picado: 1 = Basto, 2 = Entrefino

Escofina plana paralela



ergo®



6-344...-2

Longitud	Picados	€	Paquete	Artículo
200 mm	2	14,48	5	6-344-08-2-2
250 mm	2	17,60	5	6-344-10-2-2

Tipo de picado: 1-basto/ 2-entrefino

Escofina media caña



6-342...-0

Longitud	Picados	€	Paquete	Artículo
150 mm	2	8,67	10	6-342-06-2-0
200 mm	1	10,01	10	6-342-08-1-0
200 mm	2	11,64	10	6-342-08-2-0
250 mm	1	13,67	10	6-342-10-1-0
250 mm	2	14,75	10	6-342-10-2-0

Tipo de picado: 1 = Basto, 2 = Entrefino

Escofina media caña



ergo®



6-342...-2

Longitud	Picados	€	Paquete	Artículo
150 mm	2	12,06	5	6-342-06-2-2
200 mm	1	13,53	5	6-342-08-1-2
200 mm	2	16,25	5	6-342-08-2-2
250 mm	1	16,80	5	6-342-10-1-2
250 mm	2	19,91	5	6-342-10-2-2

Tipo de picado: 1 = Basto, 2 = Entrefino

Escofina media caña, lengua de vaca



6-343...-0

Longitud	Picados	€	Paquete	Artículo
200 mm	2	15,42	10	6-343-08-2-0
200 mm	3	17,60	10	6-343-08-3-0
250 mm	2	19,63	10	6-343-10-2-0
250 mm	3	22,48	10	6-343-10-3-0

Tipo de picado: 1 = Basto, 2 = Entrefino

Escofina media caña, lengua de vaca



ergo®



6-343...-2

Longitud	Picados	€	Paquete	Artículo
200 mm	2	17,95	5	6-343-08-2-2
250 mm	2	21,94	5	6-343-10-2-2

Tipo de picado: 1 = Basto, 2 = Entrefino

Escofina redonda



6-345...-0

Longitud	Cant.	€	Paquete	Artículo
200 mm	2	9,59	10	6-345-08-2-0
250 mm	2	11,60	10	6-345-10-2-0

Tipo de picado: 1 = Basto, 2 = Entrefino

Escofina redonda



6-345...-2

Longitud	Cant.	€	Paquete	Artículo
200 mm	1	10,91	5	6-345-08-1-2
200 mm	2	11,13	5	6-345-08-2-2
250 mm	1	13,81	5	6-345-10-1-2

Tipo de picado: 1 = Basto, 2 = Entrefino

Juego de 3 escofinas ERGO™



6-470

Longitud	Cant.	€	Paquete	Artículo
200 mm	2	53,47	5	6-470-08-2-2

6-345-08-2-2

6-342-08-2-2

4-152-08-2-2

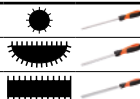

LIMAS CON DIENTES FRESADOS

Hoja plana Pansar®



3-330

Longitud	Cant.	€	Paquete	Artículo
300 mm	1	26,59	5	3-330-12-1-0
300 mm	2	28,39	5	3-330-12-2-0
350 mm	1	28,57	5	3-330-14-1-0
350 mm	2	32,80	5	3-330-14-2-0

Hoja 12" para portalimas 9-462 y 9-463, hoja 14" para portalimas 9-462

Hoja de media caña Pansar®



3-331

Longitud	Cant.	€	Paquete	Artículo
350 mm	1	29,11	5	3-331-14-1-0

Tipo de picado: 1 = Basto, 2 = Entrefino

Lima patrón



FM10

Longitud	Cant.	€	Paquete	Artículo
300 mm	4 & 5	18,55	5	FM12
250 mm	4 & 5	18,55	5	FM10

Un lado con picado cizalla, por el otro dentado curvado

Lima patrón, media caña



HRFM10

Longitud	Cant.	€	Paquete	Artículo
250 mm	5	22,65	5	HRFM10

LIMAS DE AGUJA

Lima plana paralela



2-300

Longitud	Cant.	€	Paquete	Artículo
140 mm	0	7,73	10	2-300-14-0-0
140 mm	2	7,73	10	2-300-14-2-0
140 mm	4	8,15	10	2-300-14-4-0
160 mm	0	8,39	10	2-300-16-0-0
160 mm	1	8,39	10	2-300-16-1-0
160 mm	2	8,39	10	2-300-16-2-0
160 mm	4	8,90	10	2-300-16-4-0
180 mm	0	9,76	10	2-300-18-0-0
180 mm	2	9,76	10	2-300-18-2-0

Tipo de picado: 0 = Basto, 1 = Entrefino, 2 = Fino, 4 = Super-fino

Lima plana



2-301

Longitud	Cant.	€	Paquete	Artículo
140 mm	0	8,90	10	2-301-14-0-0
140 mm	2	8,90	10	2-301-14-2-0
160 mm	0	9,76	10	2-301-16-0-0
160 mm	1	9,76	10	2-301-16-1-0
160 mm	2	9,76	10	2-301-16-2-0

Tipo de picado: 0 = Basto, 1 = Entrefino, 2 = Fino, 4 = Super-fino



Lima media caña



2-304

			€		
140 mm	0	10,14	10	2-304-14-0-0	
140 mm	2	10,14	10	2-304-14-2-0	
140 mm	4	10,93	10	2-304-14-4-0	
160 mm	0	11,18	10	2-304-16-0-0	
160 mm	1	11,18	10	2-304-16-1-0	
160 mm	2	11,18	10	2-304-16-2-0	
160 mm	4	11,81	10	2-304-16-4-0	
180 mm	0	12,92	10	2-304-18-0-0	
180 mm	2	12,92	10	2-304-18-2-0	

Tipo de picado: 0 = Basto, 1 = Entrefino, 2 = Fino, 4 = Super-fino

Lima marking



2-313

			€		
160 mm	0	11,18	10	2-313-16-0-0	

Tipo de picado: 0 = Basto, 1 = Entrefino, 2 = Fino, 4 = Super-fino

Lima redonda



2-307

			€		
140 mm	0	7,73	10	2-307-14-0-0	
140 mm	2	7,73	10	2-307-14-2-0	
140 mm	4	8,15	10	2-307-14-4-0	
160 mm	0	8,39	10	2-307-16-0-0	
160 mm	1	8,39	10	2-307-16-1-0	
160 mm	2	8,39	10	2-307-16-2-0	
160 mm	4	8,90	10	2-307-16-4-0	
180 mm	0	9,76	10	2-307-18-0-0	
180 mm	2	9,76	10	2-307-18-2-0	

Tipo de picado: 0 = Basto, 1 = Entrefino, 2 = Fino, 4 = Super-fino

Lima ovalada



2-305

			€		
160 mm	1	11,18	10	2-305-16-1-0	
160 mm	2	11,18	10	2-305-16-2-0	

Tipo de picado: 0 = Basto, 1 = Entrefino, 2 = Fino, 4 = Super-fino

Lima semi-ovalada



2-306

			€		
160 mm	1	11,18	10	2-306-16-1-0	
160 mm	2	11,18	10	2-306-16-2-0	

Tipo de picado: 0 = Basto, 1 = Entrefino, 2 = Fino, 4 = Super-fino

Lima triangular



2-302

			€		
140 mm	0	8,90	10	2-302-14-0-0	
140 mm	2	8,90	10	2-302-14-2-0	
140 mm	4	9,28	10	2-302-14-4-0	
160 mm	0	9,76	10	2-302-16-0-0	
160 mm	1	9,76	10	2-302-16-1-0	
160 mm	2	9,76	10	2-302-16-2-0	
160 mm	4	10,14	10	2-302-16-4-0	
180 mm	0	11,18	10	2-302-18-0-0	
180 mm	2	11,18	10	2-302-18-2-0	

Tipo de picado: 0 = Basto, 1 = Entrefino, 2 = Fino, 4 = Super-fino

Lima Barrette



2-309

			€		
160 mm	2	9,76	10	2-309-16-2-0	
160 mm	4	10,14	10	2-309-16-4-0	

Tipo de picado: 0 = Basto, 1 = Entrefino, 2 = Fino, 4 = Super-fino

Lima cuchillo



2-308

			€		
140 mm	2	10,14	10	2-308-14-2-0	
160 mm	0	11,18	10	2-308-16-0-0	
160 mm	1	11,18	10	2-308-16-1-0	
160 mm	2	11,18	10	2-308-16-2-0	

Tipo de picado: 0 = Basto, 1 = Entrefino, 2 = Fino, 4 = Super-fino

Lima cuadrada



2-303

			€		
140 mm	2	8,90	10	2-303-14-2-0	
160 mm	0	9,76	10	2-303-16-0-0	
160 mm	1	9,76	10	2-303-16-1-0	
160 mm	2	9,76	10	2-303-16-2-0	
160 mm	4	10,14	10	2-303-16-4-0	
180 mm	0	11,18	10	2-303-18-0-0	
180 mm	2	11,18	10	2-303-18-2-0	

Tipo de picado: 0 = Basto, 1 = Entrefino, 2 = Fino, 4 = Super-fino

Juego de 6 limas de aguja + 1 mango

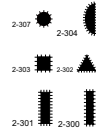

2-470

		€		
140 mm	0	47,92	10	2-470-14-0-0

9-488-02-10	
2-304-14-0-0	
2-300-14-0-0	
2-303-14-0-0	
2-302-14-0-0	
2-301-14-0-0	
2-307-14-0-0	

Juego de 6 limas de aguja + 1 mango



2-470-14-2-0

		€		
140 mm	2	46,75	10	2-470-14-2-0

9-488-02-10	
2-304-14-2-0	
2-300-14-2-0	
2-303-14-2-0	
2-302-14-2-0	
2-301-14-2-0	
2-307-14-2-0	

Juego de 6 limas de aguja + 1 mango



2-470-14-4-0

		€		
140 mm	4	51,03	10	2-470-14-4-0

9-488-02-10	
2-304-14-4-0	
2-300-14-4-0	
2-303-14-4-0, 2-301-14-4-0	
2-302-14-4-0	
2-307-14-4-0	

Juego de 6 limas de aguja + 1 mango



2-470-16-1-0

		€		
160 mm	1	49,21	10	2-470-16-1-0

9-488-02-10	
2-304-16-1-0	
2-300-16-1-0	
2-303-16-1-0	
2-302-16-1-0	
2-301-16-1-0	
2-307-16-1-0	

Juego de 6 limas de aguja + 1 mango



2-470-16-2-0

		€		
160 mm	2	50,75	10	2-470-16-2-0

9-488-02-10	
2-304-16-2-0	
2-300-16-2-0	
2-303-16-2-0	
2-302-16-2-0	
2-301-16-2-0	
2-307-16-2-0	

Juego de 9 limas de aguja + 1 mango



2-471

		€		
160 mm	1	83,52	5	2-471-16-1-0

9-488-02-10	
2-303-16-1-0	
2-304-16-1-0	
2-302-16-1-0	
2-300-16-1-0	
2-308-16-1-0	
2-301-16-1-0	
2-306-16-1-0	
2-305-16-1-0	
2-307-16-1-0	



Juego de 12 limas de aguja + 1 mango



2-472

		€		
140 mm	0	91,20	5	2-472-14-0-0

2-303-14-0-0, 2-313-14-0-0, 2-309-14-0-0, 2-306-14-0-0

2-300-14-0-0	
2-301-14-0-0	
2-304-14-0-0	
2-302-14-0-0	
2-307-14-0-0	
9-488-02-10	

Juego de 12 limas de aguja



2-472-14-2-0

		€		
140 mm	2	91,20	5	2-472-14-2-0

2-303-14-2-0	
2-300-14-2-0	
2-301-14-2-0	
2-304-14-2-0	
2-302-14-2-0	
2-313-14-2-0, 2-306-14-2-0	
2-307-14-2-0	
2-308-14-2-0	
9-488-02-10	

Juego de 12 limas de aguja



2-472-16-0-0

		€		
160 mm	0	98,42	5	2-472-16-0-0

2-303-16-0-0	
2-300-16-0-0	
2-301-16-0-0	
2-304-16-0-0	
2-302-16-0-0	
2-313-16-0-0	
2-307-16-0-0	
2-306-16-0-0	
2-308-16-0-0	
9-488-02-10	

Juego de 12 limas de aguja



2-472-16-1-0

		€		
160 mm	1	98,42	5	2-472-16-1-0

2-303-16-1-0	
2-301-16-1-0	
2-302-16-1-0	
2-303-16-1-0	
2-304-16-1-0	
2-306-16-1-0	
2-307-16-1-0	
2-308-16-1-0	
2-309-16-2-0	
2-311-16-2-0	
2-313-16-2-0	
9-488-02-10	

Juego de 12 limas de aguja



2-472-16-2-0

		€		
160 mm	2	98,42	5	2-472-16-2-0

2-303-16-2-0	
2-300-16-2-0	
2-301-16-2-0	
2-311-16-2-0	
2-304-16-2-0	
2-302-16-2-0	
2-313-16-2-0	
2-307-16-2-0	
2-309-16-2-0	
2-306-16-2-0	
2-308-16-2-0	
9-488-02-10	

LIMAS DE DIAMANTE

Limas de aguja de diamante



2-300-D - 2-304-D

	€		
140 mm	53,89	10	2-300-14-D-1P
160 mm	72,31	10	2-300-16-D-1P
140 mm	53,89	1	2-301-14-D-1P
140 mm	59,30	10	2-302-14-D-1P
160 mm	79,30	10	2-302-16-D-1P
140 mm	53,89	10	2-303-14-D-1P
160 mm	72,31	1	2-303-16-D-1P
140 mm	59,30	10	2-304-14-D-1P
160 mm	79,30	10	2-304-16-D-1P

Limas de aguja de diamante



2-306-D - 2-308-D

	€		
140 mm	59,30	1	2-306-14-D-1P
140 mm	53,89	10	2-307-14-D-1P
160 mm	72,31	10	2-307-16-D-1P
140 mm	59,30	1	2-308-14-D-1P

Mango universal para limas de aguja



9-488-02

g	€		
5 g	2,54	10	9-488-02-10

Cepillo para limas



9-469

	L	€		
110 mm	240 mm	16,46	1	9-469-00-0-0

Limas de precisión de diamante



5-600-D - 5-670-D

	€		
215 mm	136,96	10	5-600-21-D-1P
215 mm	135,88	5	5-610-21-D-1P
215 mm	97,03	1	5-630-21-D-1P
215 mm	144,08	1	5-670-21-D-1P

Mango para limas de cadenas de motosierra



PH-6604

g	€		
55 g	3,11	15	PH-6604-1P
50 g	1,99	25	PH-6604-25

Mango bimaterial ERGO™ para limas pequeñas



9-484...10

	€		
3.2 3.2 mm	1,78	10	9-484-3.2-10
5.2 5.2 mm	1,78	10	9-484-5.2-10

ACCESORIOS

Portalimas Pansar®



9-462

L	€		
350 mm	56,83	5	9-462-14-0-0

Cepillo para limas



9-467

	L	€		
130 mm	260 mm	43,24	1	9-467-00-0-0

Mango bimaterial ERGO™ para limas pequeñas



9-484...1P

	€		
3.2 3.2 mm	3,07	10	9-484-3.2-1P
5.2 5.2 mm	3,07	10	9-484-5.2-1P



Mango bimaterial ERGO™ para limas planas



ergo



9-485...10

			€		
4	4 mm	3,07	10	9-485-04-10	
5	5 mm	3,07	10	9-485-05-10	
6	6 mm	3,34	10	9-485-06-10	
9	9 mm	3,34	10	9-485-09-10	
13	13 mm	3,34	10	9-485-13-10	

Mango bimaterial ERGO™ para limas planas



ergo



9-485...1P

			€		
4	4 mm	3,07	10	9-485-04-1P	
5	5 mm	3,07	10	9-485-05-1P	
6	6 mm	4,50	20	9-485-06-1P	
9	9 mm	4,50	20	9-485-09-1P	
13	13 mm	4,50	1	9-485-13-1P	

Para limas planas, punta sin mango y semiesféricas

Mango bimaterial ERGO™ para limas



ergo



9-486-C-10

			€		
3.2	3.2 mm	3,19	10	9-486-C-10	

Mango bimaterial ERGO™ para limas



ergo



9-486-C-1P

			€		
3.2	3.2 mm	4,26	10	9-486-C-1P	

Mango bimaterial ERGO™ para limas



ergo



9-486...10

			€		
4	4 mm	3,34	10	9-486-04-10	
5	5 mm	3,34	10	9-486-05-10	
7	7 mm	3,35	10	9-486-07-10	
8	8 mm	4,49	10	9-486-08-10	

Mango bimaterial ERGO™ para limas



ergo



9-486...1P

			€		
4	4 mm	4,50	20	9-486-04-1P	
5	5 mm	4,50	20	9-486-05-1P	
7	7 mm	4,50	20	9-486-07-1P	



Llaves



LLAVES AJUSTABLES "INGLESAS"

Llave ajustable pavonada



ergo



90

L	Hand	€	Box	Icon
158mm/6"	20 mm	29,11	5	9070
208mm/8"	27 mm	31,61	5	9071
257mm/10"	31 mm	41,16	5	9072
308mm/12"	34 mm	59,86	5	9073

Llave ajustable fosfatada moleta central ERGO™, con mordaza reversible



ergo



90P

L	Hand	€	Box	Icon
158mm/6"	21 mm	32,59	5	9070 P
208mm/8"	28 mm	34,79	5	9071 P
257mm/10"	33 mm	44,61	5	9072 P
308mm/12"	35 mm	63,33	5	9073 P

Llave ajustable cromada plateada



ergo



90C

L	Hand	€	Box	Icon
158mm/6"	20 mm	26,36	5	9070 C
208mm/8"	27 mm	28,23	5	9071 C
257mm/10"	31 mm	36,36	5	9072 C
308mm/12"	34 mm	53,08	3	9073 C

Llave ajustable cromada moleta central ERGO™, con mordaza reversible



ergo



90PC

L	Hand	€	Box	Icon
158mm/6"	21 mm	29,05	5	9070 PC
208mm/8"	28 mm	31,11	5	9071 PC
257mm/10"	33 mm	39,06	5	9072 PC
308mm/12"	35 mm	55,77	3	9073 PC

Llave ajustable pavonada, gran apertura



ergo



9029-9035

L	Hand	€	Box	Icon
170mm/6"	32 mm	30,52	5	9029
218mm/8"	38 mm	33,17	5	9031
270mm/10"	46 mm	43,27	5	9033
324mm/12"	55 mm	62,72	5	9035

Llave ajustable especial



ergo



9029C/9031C

L	Hand	€	Box	Icon
170mm/6"	32 mm	35,78	5	9029 C
218mm/8"	38 mm	38,37	5	9031 C

Llave ajustable, gran apertura, mordazas extra finas



ergo



9029-T/9031-T

L	Hand	€	Box	Icon
170mm/6"	32 mm	35,20	5	9029-T
218mm/8"	38 mm	40,96	5	9031-T

Llave ajustable, gran apertura y mordazas reversibles



ergo



9031P

L	Hand	€	Box	Icon
218mm/8"	39 mm	35,94	5	9031P

Juego 3 ajustables serie 90 con mango termoplástico (6", 8" y 10")



ergo



ADJUST3-90

g	€	Box	Icon
900 g	91,11	1	ADJUST 3-90

9070, 9071, 9072



Juego de llaves 9031 & 9029



ergo



ADJUST9031/29

g	€	Icon	Icon
550 g	63,71	3	ADJUST 9031/29

9029, 9031

Llave ajustable, fosfatada



80

L	Icon	€	Icon	Icon
110mm/4"	13 mm	22,33	5	8069
155mm/6"	20 mm	23,45	5	8070
205mm/8"	27 mm	25,44	5	8071
255mm/10"	31 mm	33,16	5	8072
305mm/12"	34 mm	48,19	5	8073
380mm/15"	44 mm	78,75	3	8074
455mm/18"	53 mm	123,74	3	8075
110mm/4"	13 mm	21,62	50	8069 IP
155mm/6"	20 mm	22,81	40	8070 IP
205mm/8"	27 mm	24,80	50	8071 IP
255mm/10"	31 mm	32,51	30	8072 IP
305mm/12"	34 mm	47,55	20	8073 IP
380mm/15"	44 mm	78,12	20	8074 IP
455mm/18"	53 mm	123,08	10	8075 IP

Llave ajustable moleta central, cromada



80C

L	Icon	€	Icon	Icon
110mm/4"	13 mm	16,40	5	8069 C
155mm/6"	20 mm	16,83	5	8070 C
205mm/8"	27 mm	19,13	5	8071 C
255mm/10"	31 mm	23,20	5	8072 C
305mm/12"	34 mm	30,54	5	8073 C
380mm/15"	44 mm	51,31	3	8074 C
455mm/18"	53 mm	79,61	3	8075 C

L	Icon	€	Icon	Icon
110mm/4"	13 mm	15,90	5	8069 C IP
155mm/6"	20 mm	16,31	5	8070 C IP
205mm/8"	27 mm	18,65	5	8071 C IP
255mm/10"	31 mm	22,71	5	8072 C IP
305mm/12"	34 mm	30,04	5	8073 C IP
380mm/15"	44 mm	50,80	3	8074 C IP
455mm/18"	53 mm	79,13	3	8075 C IP

IP: Embalaje industrial

Llave ajustable gran tamaño



86/87

L	Icon	€	Icon	Icon
614mm/24"	63 mm	277,02	1	86
770mm/30"	85 mm	282,88	3	87

Juego 3 llaves ajustables serie 80 (6", 8" y 10")



ADJUST3

g	€	Icon	Icon
810 g	77,58	1	ADJUST 3

8070, 8071, 8072

Repuestos para llaves ajustables



RPS

Icon	€	Icon	Icon
8069, 8069 C	4,88	1	8069-1
8070, 8070 C, 9070, 9070 C	5,65	1	8070-1
8071, 8071 C, 9071, 9071 C	5,24	1	8071-1

Icon	€	Icon	Icon
8072, 8072 C, 9072, 9072 C	5,44	1	8072-1
8073, 8073 C, 9073, 9073 C	6,28	1	8073-1
8074, 8074 C	10,20	1	8074-1
8075, 8075 C	13,53	1	8075-1
9029, 9029 C, 31	5,99	1	9029-1
9029-T	13,35	1	9029T-1
9031, 9031 C	5,80	1	9031-1
9031-T	13,46	1	9031T-1
9033, 33H	12,66	1	9033-1
9035	14,15	1	9035-1
86	8,06	1	86-1
87	10,12	1	87-1
9031 P	8,40	1	9031 P-1
9070 P, 9070 PC	8,16	1	9070 P-1
9071 P, 9071 PC	7,97	1	9071 P-1
9072 P, 9072 PC	8,77	1	9072 P-1
9073 P, 9073 PC	9,95	1	9073 P-1

-1: mordaza -2: tornillo y muelle

Moleta, pasador y muelle de repuesto para llaves ajustables "inglesas" con moleta central



RPS2

Icon	g	€	Icon	Icon
8069, 8069 C	3 g	2,97	1	8069-2
8070, 8070 C, 9070, 9070 C, 9070 P, 9070 PC	8 g	3,10	1	8070-2
8071, 8071 C, 9071, 9071 C, 9071 P, 9071 PC	10 g	3,13	1	8071-2
8072, 8072 C, 9072, 9072 C, 9072 P, 9072 PC	16 g	3,43	1	8072-2
8073, 8073 C, 9073, 9073 C, 9073 P, 9073 PC, 9033	25 g	3,77	1	8073-2
8074, 8074 C, 9035	47 g	4,43	1	8074-2
8075, 8075 C	54 g	4,95	1	8075-2
9029, 9029 C, 9029-T, 9031-T, 31, 9031, 9031 C, 9031P	9 g	3,43	1	9029-2
86	125 g	6,78	1	86-2
87	185 g	7,11	1	87-2



Llave ajustable podger, serie larga



84

L	W	€	Box	Icon
405mm/16"	41 mm	37,11	1	84-PODGER

Llave ajustable función tubo



31

L	W	€	Box	Icon
209mm/8"	32 mm	37,25	5	31
209mm/8"	32 mm	35,87	50	31-IP

Llave ajustable "inglesa" con mordazas finas y acabado fosfatado



31-T

L	W	€	Box	Icon
209mm/8"	32 mm	35,87	5	31-T
209mm/8"	32 mm	35,87	50	31-T-IP

Llave ajustable para volantes de válvulas



33H

L	W	€	Box	Icon
254mm/10"	46 mm	66,38	5	33H

Llave ajustable fosfatada, Industria pesada



95

L	W	€	Box	Icon
257mm/10"	35 mm	48,19	5	9572

Llave ajustable de moleta lateral, cromada



91C/97C

L	W	€	Box	Icon
155mm/6"	21 mm	27,40	5	91C
205mm/8"	29 mm	31,24	5	92C
255mm/10"	34 mm	37,07	5	93C
305mm/12"	39 mm	47,37	5	94C
405mm/16"	48 mm	79,28	1	95C
500mm/20"	60 mm	150,69	1	96C
750mm/30"	77 mm	294,44	1	97C



LLAVES COMBINADAS

Llaves combinadas, mm



111M

W	€	Box	Icon
5.5 mm	6,39	10	111M-5.5
6 mm	5,81	10	111M-6
7 mm	5,87	10	111M-7
8 mm	6,04	10	111M-8
9 mm	7,21	10	111M-9
10 mm	7,26	10	111M-10
11 mm	7,89	10	111M-11
12 mm	8,33	10	111M-12
13 mm	8,77	10	111M-13
14 mm	9,13	10	111M-14
15 mm	9,46	10	111M-15
16 mm	10,00	10	111M-16
17 mm	10,69	10	111M-17
18 mm	11,27	10	111M-18
19 mm	12,88	10	111M-19
20 mm	13,03	10	111M-20
21 mm	14,89	10	111M-21
22 mm	15,02	5	111M-22
23 mm	15,90	5	111M-23
24 mm	16,63	5	111M-24
25 mm	18,04	5	111M-25
26 mm	21,41	5	111M-26
27 mm	23,55	5	111M-27
28 mm	25,16	5	111M-28
29 mm	25,79	5	111M-29
30 mm	28,69	5	111M-30
32 mm	30,92	5	111M-32
33 mm	33,26	5	111M-33
34 mm	35,79	5	111M-34
36 mm	50,58	1	111M-36
38 mm	59,82	1	111M-38
41 mm	64,22	1	111M-41
46 mm	84,69	1	111M-46
50 mm	95,92	1	111M-50
55 mm	167,26	1	111M-55
60 mm	221,89	1	111M-60
65 mm	295,49	1	111M-65
70 mm	351,24	1	111M-70
75 mm	442,67	1	111M-75
80 mm	510,69	1	111M-80
85 mm	687,01	1	111M-85
90 mm	695,25	1	111M-90
95 mm	697,31	1	111M-95
100 mm	715,85	1	111M-100
5.5 mm	6,80	1	SB111M-5,5
6 mm	7,05	1	SB111M-6
7 mm	7,10	1	SB111M-7
8 mm	7,27	1	SB111M-8
9 mm	8,49	1	SB111M-9
10 mm	8,55	1	SB111M-10
11 mm	9,20	1	SB111M-11
12 mm	9,64	1	SB111M-12
13 mm	10,11	1	SB111M-13
14 mm	10,51	1	SB111M-14
15 mm	10,83	1	SB111M-15



	€		
16 mm	11,64	1	SB111M-16
17 mm	12,14	1	SB111M-17
18 mm	12,71	1	SB111M-18
19 mm	14,41	1	SB111M-19
20 mm	14,52	1	SB111M-20
21 mm	16,49	1	SB111M-21
22 mm	16,61	1	SB111M-22
23 mm	17,54	1	SB111M-23
24 mm	18,32	1	SB111M-24
25 mm	19,77	1	SB111M-25
26 mm	19,25	1	SB111M-26
27 mm	21,55	1	SB111M-27
28 mm	26,58	1	SB111M-28
29 mm	28,79	1	SB111M-29
30 mm	30,83	1	SB111M-30
32 mm	34,31	1	SB111M-32

SB- Presentación para colgar

Llave combinada, pulgadas





111Z

	€		
1/4 in	6,07	5	111Z-1/4
5/16 in	6,27	5	111Z-5/16
3/8 in	7,62	5	111Z-3/8
7/16 in	8,30	5	111Z-7/16
1/2 in	9,18	5	111Z-1/2
9/16 in	9,67	5	111Z-9/16
5/8 in	10,49	5	111Z-5/8
11/16 in	11,10	5	111Z-11/16
3/4 in	13,29	5	111Z-3/4
13/16 in	15,45	5	111Z-13/16
7/8 in	15,71	5	111Z-7/8
15/16 in	17,50	3	111Z-15/16
1 in	18,90	3	111Z-1
1 1/16 in	24,51	5	111Z-1.1/16
1 1/8 in	26,19	5	111Z-1.1/8
1 1/4 in	32,05	5	111Z-1.1/4
1 5/16 in	37,30	5	111Z-1.5/16
1 3/8 in	52,51	1	111Z-1.3/8
1 7/16 in	52,51	1	111Z-1.7/16
1 1/2 in	55,17	1	111Z-1.1/2
1 5/8 in	66,68	1	111Z-1.5/8
1 11/16 in	86,12	1	111Z-1.11/16
1 3/4 in	92,40	1	111Z-1.3/4
1 13/16 in	85,94	1	111Z-1.13/16
1 7/8 in	98,28	1	111Z-1.7/8
2 in	99,62	1	111Z-2
2 1/8 in	175,25	1	111Z-2.1/8
2 1/4 in	175,25	1	111Z-2.1/4
2 3/8 in	242,21	1	111Z-2.3/8
2 1/2 in	300,18	1	111Z-2.1/2
2 5/8 in	300,18	1	111Z-2.5/8
2 3/4 in	319,29	1	111Z-2.3/4
2 7/8 in	387,53	1	111Z-2.7/8
3 in	387,53	1	111Z-3

Llave combinada stubby, pulgadas



1Z

	€		
3/16 in	7,46	20	1Z-3/16
7/32 in	7,46	20	1Z-7/32
9/32 in	7,18	20	1Z-9/32
5/16 in	4,64	10	1Z-5/16
11/32 in	5,33	10	1Z-11/32
3/8 in	5,33	10	1Z-3/8
7/16 in	5,70	10	1Z-7/16
1/2 in	6,30	10	1Z-1/2
9/16 in	6,67	10	1Z-9/16
5/8 in	7,54	10	1Z-5/8
11/16 in	7,81	10	1Z-11/16
3/4 in	9,01	10	1Z-3/4
13/16 in	10,43	10	1Z-13/16
7/8 in	10,43	10	1Z-7/8
15/16 in	16,59	5	1Z-15/16
1 in	16,83	10	1Z-1

Llave combinada, mm



S20

	€		
9	5,83	1	SBS20-9
12	6,92	1	SBS20-12
15	7,83	1	SBS20-15
16	8,38	1	SBS20-16
20	11,54	1	SBS20-20

Juego de 5 llaves combinadas, mm



111M/SH5

	€		
5	45,64	1	111M/SH5

111M-8, 111M-10, 111M-13, 111M-17, 111M-19

Juego de 8 llaves combinadas, mm



111M/SH8

	€		
8	84,26	1	111M/SH8

111M-8, 111M-10, 111M-12, 111M-13, 111M-14, 111M-17, 111M-19, 111M-22

Juego de 12 llaves combinadas, mm



111M/SH12

	€		
12	120,02	1	111M/SH12

111M-8, 111M-9, 111M-10, 111M-11, 111M-12, 111M-13, 111M-14, 111M-15, 111M-16, 111M-17, 111M-18, 111M-19



Juego de 10 llaves combinadas, mm



111M/

	€		
10	94,61	1	111M/S10

111M-8, 111M-9, 111M-10, 111M-11, 111M-12, 111M-13, 111M-14, 111M-17, 111M-19, 111M-22



Juego de 11 llaves combinadas, mm



111M/11T

	€		
11	107,88	1	111M/11T

111M-8, 111M-9, 111M-10, 111M-11, 111M-12, 111M-13, 111M-14, 111M-15, 111M-17, 111M-19, 111M-22



Juego de 14 llaves combinadas, mm



111M/14T

	€		
14	199,01	1	111M/14T

111M-6, 111M-8, 111M-9, 111M-10, 111M-13, 111M-14, 111M-15, 111M-17, 111M-19, 111M-22, 111M-24, 111M-27, 111M-30, 111M-32



Juego de 17 llaves combinadas, mm



111M/17T

	€		
17	172,23	1	111M/17T

111M-6, 111M-7, 111M-8, 111M-9, 111M-10, 111M-11, 111M-12, 111M-13, 111M-14, 111M-15, 111M-16, 111M-17, 111M-18, 111M-19, 111M-20, 111M-21, 111M-22



Juego de 17 llaves combinadas, mm



111M/17TL

	€		
17	221,71	1	111M/17TL

111M-8, 111M-9, 111M-10, 111M-11, 111M-12, 111M-13, 111M-14, 111M-15, 111M-16, 111M-18, 111M-19, 111M-22, 111M-24, 111M-26, 111M-27, 111M-30, 111M-32



Juego de 24 llaves combinadas, mm



111M/24T

	€		
24	364,21	1	111M/24T

111M-6, 111M-7, 111M-8, 111M-9, 111M-10, 111M-11, 111M-12, 111M-13, 111M-14, 111M-15, 111M-16, 111M-17, 111M-18, 111M-19, 111M-20, 111M-21, 111M-22, 111M-24, 111M-26, 111M-27, 111M-28, 111M-30, 111M-32, 111M-36



Juego de 26 llaves combinadas, mm



111M/26T

	€		
26	380,62	1	111M/26T

111M-6, 111M-7, 111M-8, 111M-9, 111M-10, 111M-11, 111M-12, 111M-13, 111M-14, 111M-15, 111M-16, 111M-17, 111M-18, 111M-19, 111M-20, 111M-21, 111M-22, 111M-23, 111M-24, 111M-25, 111M-26, 111M-27, 111M-28, 111M-29, 111M-30, 111M-32



Juegos de 8 llaves combinadas, pulgadas



111Z/

	€		
8	95,86	1	111Z/8T

111Z-3/8, 111Z-7/16, 111Z-1/2, 111Z-9/16, 111Z-5/8, 111Z-11/16, 111Z-3/4, 111Z-7/8



Juegos de 11 llaves combinadas, pulgadas



111Z/11T



€



11

153,78

1

111Z/11T

111Z-3/8, 111Z-7/16, 111Z-1/2, 111Z-9/16, 111Z-5/8, 111Z-11/16, 111Z-3/4, 111Z-13/16, 111Z-7/8, 111Z-15/16, 111Z-1



Llave combinada extra larga, mm



11M



€



8 mm

11,42

5

11M-8

9 mm

11,42

5

11M-9

10 mm

12,00

5

11M-10

11 mm

12,00

5

11M-11

12 mm

13,73

5

11M-12

13 mm

13,73

5

11M-13

14 mm

16,57

5

11M-14

15 mm

16,57

5

11M-15

16 mm

18,18

5

11M-16

17 mm

18,76

5

11M-17

18 mm

18,89

5

11M-18

19 mm

23,75

5

11M-19

21 mm

23,75

5

11M-21

22 mm

17,81

5

11M-22

24 mm

30,42

5

11M-24

27 mm

39,45

1

11M-27

30 mm

47,73

1

11M-30

32 mm

47,73

1

11M-32

36 mm

61,36

1

11M-36

38 mm

65,02

1

11M-38

Llave combinada acodada extra larga, pulgadas



11Z



€



3/8 in

11,41

5

11Z-3/8

7/16 in

11,80

5

11Z-7/16

1/2 in

12,15

5

11Z-1/2

9/16 in

12,58

5

11Z-9/16

5/8 in

15,05

5

11Z-5/8

11/16 in

15,05

5

11Z-11/16

3/4 in

16,85

5

11Z-3/4

13/16 in

17,66

5

11Z-13/16

1 in

37,41

5

11Z-1

Llave combinada Liliput, mm



4020L-M



€



3.2 mm

19,59

5

4020L-M-3.2

3.5 mm

19,59

5

4020L-M-3.5

4 mm

18,50

5

4020L-M-4

4.5 mm

18,50

5

4020L-M-4.5

5 mm

18,50

5

4020L-M-5

5.5 mm

18,50

5

4020L-M-5.5

Llaves combinadas acodadas, mm



1952M



€



6 mm

9,18

10

1952M-6

7 mm

9,18

10

1952M-7

8 mm

9,07

10

1952M-8

9 mm

10,20

10

1952M-9

10 mm

10,20

10

1952M-10

11 mm

10,94

10

1952M-11

12 mm

11,56

10

1952M-12

13 mm

12,53

10

1952M-13

14 mm

12,64

10

1952M-14

15 mm

14,96

10

1952M-15



€



16 mm

16,18

10

1952M-16

17 mm

16,72

10

1952M-17

18 mm

18,71

10

1952M-18

19 mm

19,61

10

1952M-19

20 mm

20,77

10

1952M-20

21 mm

21,58

10

1952M-21

22 mm

24,20

5

1952M-22

23 mm

26,14

5

1952M-23

24 mm

27,32

5

1952M-24

25 mm

29,16

5

1952M-25

26 mm

29,44

5

1952M-26

27 mm

31,39

5

1952M-27

28 mm

35,79

1

1952M-28

29 mm

38,20

1

1952M-29

30 mm

40,11

1

1952M-30

32 mm

41,94

1

1952M-32

Llave combinada acodada, mm



PU

	€		
6 mm	7,30	5	PU-6
9 mm	8,84	5	PU-9
14 mm	10,91	5	PU-14
20 mm	16,06	3	PU-20
22 mm	21,50	3	PU-22
24 mm	24,48	3	PU-24

Producto no disponible para España

Juego de 6 llaves combinadas acodadas, mm



1952M/SH

	€		
6	79,43	1	1952M/SH6

1952M-8, 1952M-10, 1952M-12, 1952M-13, 1952M-14, 1952M-17

Juego de 12 llaves combinadas acodadas, mm



1952M/SH12

	€		
12	176,72	1	1952M/SH12

1952M-8, 1952M-9, 1952M-10, 1952M-11, 1952M-12, 1952M-13, 1952M-14, 1952M-15, 1952M-16, 1952M-17, 1952M-18, 1952M-19

Juego de 10 llaves combinadas, acodadas, mm



1952M/

	€		
10	128,45	1	1952M/10

1952M-8, 1952M-9, 1952M-10, 1952M-11, 1952M-12, 1952M-13, 1952M-14, 1952M-16, 1952M-17, 1952M-19

Juegos de 7 llaves combinadas acodadas, mm



1952M/T

	€		
7	109,13	1	1952M/7T

1952M-8, 1952M-10, 1952M-13, 1952M-14, 1952M-17, 1952M-19, 1952M-22

Juego de 14 llaves combinadas acodadas, mm



1952M/14T

	€		
14	286,77	1	1952M/14T

1952M-6, 1952M-8, 1952M-9, 1952M-10, 1952M-13, 1952M-14, 1952M-15, 1952M-17, 1952M-19, 1952M-22, 1952M-24, 1952M-27, 1952M-30, 1952M-32

Juego de 17 llaves combinadas, acodadas, mm



1952M/17T

	€		
17	258,69	1	1952M/17T

1952M-6, 1952M-7, 1952M-8, 1952M-9, 1952M-10, 1952M-11, 1952M-12, 1952M-13, 1952M-14, 1952M-15, 1952M-16, 1952M-17, 1952M-18, 1952M-19, 1952M-20, 1952M-21, 1952M-22

Juego de 26 llaves combinadas, acodadas, mm



1952M/26T

	€		
26	557,38	1	1952M/26T

1952M-6, 1952M-7, 1952M-8, 1952M-9, 1952M-10, 1952M-11, 1952M-12, 1952M-13, 1952M-14, 1952M-15, 1952M-16, 1952M-17, 1952M-18, 1952M-19, 1952M-20, 1952M-21, 1952M-22, 1952M-23, 1952M-24, 1952M-25, 1952M-26, 1952M-27, 1952M-28, 1952M-29, 1952M-30, 1952M-32

Juego de 11 llaves combinadas acodadas, pulgadas



1952Z/T

	€		
11	179,90	1	1952Z/11T

1952Z-1/4, 1952Z-5/16, 1952Z-3/8, 1952Z-7/16, 1952Z-1/2, 1952Z-9/16, 1952Z-5/8, 1952Z-11/16, 1952Z-3/4, 1952Z-13/16, 1952Z-7/8

LLAVES DE CARRACA

Llave combinada de carraca reversible, mm



1RM

	€		
6 mm	22,55	1	1RM-6
7 mm	22,55	1	1RM-7
8 mm	23,82	1	1RM-8
9 mm	24,12	1	1RM-9
10 mm	25,75	1	1RM-10
11 mm	27,33	1	1RM-11
12 mm	29,35	1	1RM-12
13 mm	30,40	1	1RM-13
14 mm	31,72	1	1RM-14
15 mm	32,61	1	1RM-15
16 mm	35,55	1	1RM-16
17 mm	35,86	1	1RM-17
18 mm	38,80	1	1RM-18
19 mm	39,13	1	1RM-19
21 mm	41,79	1	1RM-21
22 mm	42,15	1	1RM-22
24 mm	45,54	1	1RM-24
27 mm	53,16	1	1RM-27
30 mm	64,30	1	1RM-30
32 mm	69,96	1	1RM-32

Llave combinada con carraca, pulgadas



1RZ

	€		
1/4 in	25,90	1	1RZ-1/4
5/16 in	26,17	1	1RZ-5/16
11/32 in	22,55	1	1RZ-11/32
3/8 in	27,08	1	1RZ-3/8
7/16 in	29,88	1	1RZ-7/16
1/2 in	33,28	1	1RZ-1/2
9/16 in	34,58	1	1RZ-9/16
5/8 in	38,27	1	1RZ-5/8
11/16 in	40,71	1	1RZ-11/16
3/4 in	44,22	1	1RZ-3/4
7/8 in	48,63	1	1RZ-7/8
15/16 in	58,50	1	1RZ-15/16

Llave combinada con carraca extracorta, mm



10RM

	€		
8 mm	17,59	1	10RM-8
10 mm	19,79	1	10RM-10
13 mm	22,45	1	10RM-13
14 mm	22,82	1	10RM-14
17 mm	26,54	1	10RM-17
19 mm	29,10	1	10RM-19

Llave combinada con carraca extracorta, pulgadas



10RZ

	€		
5/16 in	19,24	1	10RZ-5/16
3/8 in	20,93	1	10RZ-3/8
7/16 in	21,84	1	10RZ-7/16

	€		
1/2 in	23,46	1	10RZ-1/2
9/16 in	24,67	1	10RZ-9/16
5/8 in	27,70	1	10RZ-5/8
11/16 in	29,12	1	10RZ-11/16
3/4 in	31,50	1	10RZ-3/4

Llave combinada con carraca articulada, mm



41RM

	€		
8 mm	22,07	1	41RM-8
10 mm	24,04	1	41RM-10
11 mm	25,27	1	41RM-11
12 mm	27,28	1	41RM-12
13 mm	28,07	1	41RM-13
14 mm	29,43	1	41RM-14
17 mm	33,27	1	41RM-17
19 mm	37,59	1	41RM-19
21 mm	39,20	1	41RM-21

Llave combinada con carraca articulada, pulgadas



41RZ

	€		
5/16 in	19,80	1	41RZ-5/16
3/8 in	20,95	1	41RZ-3/8
7/16 in	21,66	1	41RZ-7/16
1/2 in	23,68	1	41RZ-1/2
9/16 in	25,01	1	41RZ-9/16
5/8 in	28,08	1	41RZ-5/8
11/16 in	30,08	1	41RZ-11/16
3/4 in	31,32	1	41RZ-3/4
13/16 in	45,30	1	41RZ-13/16
7/8 in	45,30	1	41RZ-7/8



Juego de 6 llaves combinadas de carraca reversibles, mm



1RM/

	€		
6	183,46	1	1RM/SH6

1RM-8, 1RM-10, 1RM-12, 1RM-13, 1RM-14, 1RM-17



Juego de 8 llaves combinadas a carraca, mm



1RM/SH8

	€		
8	262,55	1	1RM/SH8

1RM-8, 1RM-10, 1RM-11, 1RM-12, 1RM-13, 1RM-14, 1RM-17, 1RM-19



Juego de 12 llaves combinadas a carraca, mm



1RM/SH12

	€		
12	387,58	10	1RM/SH12

1RM-8, 1RM-9, 1RM-10, 1RM-11, 1RM-12, 1RM-13, 1RM-14, 1RM-15, 1RM-16, 1RM-17, 1RM-18, 1RM-19



Juego 5 llaves combinadas a carraca, mm



1RM/S5

	€		
5	155,22	10	1RM/S5

1RM-8, 1RM-10, 1RM-13, 1RM-17, 1RM-19



Juego de 8 llaves combinadas con carraca, pulgadas



1RZ/

	€		
8	282,95	1	1RZ/SH8

1RZ-5/16, 1RZ-3/8, 1RZ-7/16, 1RZ-1/2, 1RZ-9/16, 1RZ-5/8, 1RZ-11/16, 1RZ-3/4



Juego de 6 llaves combinada con carraca extracortas, mm



10RM/

	€		
6	143,69	1	10RM/SH6

10RM-8, 10RM-10, 10RM-13, 10RM-14, 10RM-17, 10RM-19



Juego de 8 llaves combinadas con carraca articulada, mm



41RM/SH8

	€		
8	234,58	10	41RM/SH8

41RM-8, 41RM-10, 41RM-11, 41RM-12, 41RM-13, 41RM-14, 41RM-17, 41RM-19



Juego de llaves combinadas de carraca y adaptadores, 8 piezas



1RMA/S8

	€		
160 x 283 x 75 mm	139,75	1	1RMA/S8

1RMA-13-3/8-SQ, 1RMA-10-1/4-SQ, 1RMA-19-1/2-SQ



1RMA-13-5/16-BIT, 1RMA-10-1/4-BIT



1RM-13, 1RM-10, 1RM-19



Juego de llaves combinadas con carraca articuladas



42RM/S12

		€		
229 x 70 x 280 mm	1562 g	342,97	1	42RM/S12

Llave doble estrella plana a carraca, mm



1320RM

	€		
6-7 mm	31,05	1	1320RM-6-7
8-9 mm	31,48	1	1320RM-8-9
10-11 mm	33,39	1	1320RM-10-11
12-13 mm	35,61	1	1320RM-12-13
14-15 mm	39,41	1	1320RM-14-15
16-17 mm	43,26	1	1320RM-16-17
17-19 mm	44,58	1	1320RM-17-19
18-19 mm	46,55	1	1320RM-18-19
22-24 mm	49,05	1	1320RM-22-24

Llave doble estrella plana a carraca, pulgadas



1320RZ

	€		
1/4-5/16" in	31,05	1	1320RZ-1/4-5/16
5/16-11/32 in	33,69	60	1320RZ-5/16-11/32
3/8-7/16" in	39,57	1	1320RZ-3/8-7/16
1/2-9/16" in	45,27	1	1320RZ-1/2-9/16
5/8-11/16" in	26,11	1	1320RZ-5/8-11/16
3/4-13/16" in	40,60	1	1320RZ-3/4-13/16
3/4-7/8" in	40,60	1	1320RZ-3/4-7/8
7/8-15/16" in	53,73	1	1320RZ-7/8-15/16

Llave doble de estrella a carraca acodada, pulgadas



1321RZ

	€		
3/8-7/16 in	25,37	1	1321RZ-3/8-7/16
1/2-9/16 in	28,59	1	1321RZ-1/2-9/16
5/8-11/16 in	33,10	1	1321RZ-5/8-11/16
3/4x7/8 in	46,80	1	1321RZ-3/4-7/8

Llave doble de estrella plana a carraca



1320SRM

	€		
14-19 mm	41,94	1	1320SRM-14-19

Juego de 8 llaves doble estrella plana a carraca, mm



1320RM/

	€		
8	317,35	1	1320RM/SH8

1320RM-6-7, 1320RM-8-9, 1320RM-10-11, 1320RM-12-13, 1320RM-14-15, 1320RM-16-17, 1320RM-18-19, 1320RM-22-24

Juego de llaves planas con carraca en S, 29 piezas



1320SRM/

	€		
29	130,09	1	1320SRM/S29

1320SRM-14-19

1RMA-19-17-HEX, 1RMA-19-16-HEX, 1RMA-19-15-HEX, 1RMA-19-13-HEX, 1RMA-19-9/16-HEX, 1RMA-19-5/8-HEX, 1RMA-19-11/16-HEX, 1RMA-19-1/2-HEX, 1RMA-19-E18-TX, 1RMA-19-E20-TX, 1RMA-19-E16-TX, 1RMA-19-E22-TX, 1RMA-19-1/2-SQ2, 1RMA-14-11-HEX, 1RMA-14-12-HEX, 1RMA-14-E11-TX, 1RMA-14-E12-TX, 1RMA-14-E10-TX, 1RMA-14-E14-TX, 1RMA-14-E8-TX, 1RMA-14-10-HEX, 1RMA-14-7/16-HEX, 1RMA-14-3/8-HEX, 1RMA-14-5/16-HEX, 1RMA-14-8-HEX, 1RMA-14-9-HEX

1RMA-19-1/4-SQ

SBS19-TH22

Llave de carraca 4 en 1



S4RM

	€		
4x5 6x7 mm	20,85	1	S4RM-4-7
8x9 10x11 mm	23,06	1	S4RM-8-11
12x13 14x15 mm	31,14	1	S4RM-12-15
16x17 18x19 mm	37,52	1	S4RM-16-19
20x21 24x27 mm	72,48	1	S4RM-21-27
30x32 34x36 mm	133,41	1	S4RM-30-36

Juego de 3 llaves de carraca 4 en 1



S4RM/

	€		
3	94,49	20	S4RM/3T

S4RM-8-11, S4RM-12-15, S4RM-16-19



Juego de 4 llaves de carraca 4 en 1



S4RM/4T

€		1 S4RM/4T	
4	154,46	1	S4RM/4T

S4RM-8-11, S4RM-12-15, S4RM-16-19, S4RM-21-27

Juego de 5 llaves de carraca 4 en 1



S4RM/5T

€		1 S4RM/5T	
5	311,27	1	S4RM/5T

S4RM-8-11, S4RM-12-15, S4RM-16-19, S4RM-21-27, S4RM-30-36

Adaptador para llaves con carraca para vasos 1/4", 3/8", 1/2"



1RMA-SQ

1/4 in	3/8 in	1/2 in	1/4 in	€	1 1RMA-SQ	
10 mm	13 mm	19 mm	19 mm	9,72	1	1RMA-10-1/4-SQ
				10,22	1	1RMA-13-3/8-SQ
				11,05	1	1RMA-19-1/2-SQ
				10,81	1	1RMA-19-1/4-SQ

Adaptador portapuntas para llaves con carraca



1RMA-BIT

1/4	5/16	10	10 mm	13 mm	13 mm	€	1 1RMA-BIT	
			7,63	8,37	12,03	1	1RMA-10-1/4-BIT	
						1	1RMA-13-5/16-BIT	
						1	1RMA-13-10-BIT	

Juego de 4 adaptadores para llaves de carraca



1RMA/S4

84 x 100 x 35 mm	€	1 1RMA/S4	
	38,30	1	1RMA/S4

1RMA-10-1/4-SQ, 1RMA-19-1/2-SQ, 1RMA-13-3/8-SQ

1RMA-10-1/4-BIT

LLAVES FIJAS DE DOS BOCAS

Llave fija de dos bocas, mm



6M

4x5 mm	4.5x5.5 mm	5x5.5 mm	€	6M	
			5,44	10	6M-4-5
			6,97	10	6M-4.5-5.5
			7,04	10	6M-5-5.5

	€	6M	
5.5x7 mm	5,45	10	6M-5.5-7
6x7 mm	5,45	10	6M-6-7
7x8 mm	5,78	10	6M-7-8
8x9 mm	5,48	10	6M-8-9
8x10 mm	5,89	10	6M-8-10
10x11 mm	5,96	10	6M-10-11
10x13 mm	7,32	10	6M-10-13
12x13 mm	7,25	10	6M-12-13
12x14 mm	7,76	10	6M-12-14
13x14 mm	7,69	10	6M-13-14
13x15 mm	8,53	10	6M-13-15
13x16 mm	9,24	10	6M-13-16
13x17 mm	9,07	10	6M-13-17
14x15 mm	7,69	10	6M-14-15
14x17 mm	8,92	10	6M-14-17
16x17 mm	8,92	10	6M-16-17
16x18 mm	9,76	10	6M-16-18
17x19 mm	10,05	10	6M-17-19
18x19 mm	10,05	10	6M-18-19
19x22 mm	12,16	10	6M-19-22
19x24 mm	12,90	10	6M-19-24
20x22 mm	11,91	10	6M-20-22
21x23 mm	12,98	10	6M-21-23
21x24 mm	14,33	10	6M-21-24
22x24 mm	12,96	10	6M-22-24
24x26 mm	15,08	10	6M-24-26
24x27 mm	15,37	10	6M-24-27
24x30 mm	17,79	5	6M-24-30
25x28 mm	17,52	5	6M-25-28
27x29 mm	20,86	5	6M-27-29
27x30 mm	21,77	5	6M-27-30
27x32 mm	23,82	5	6M-27-32
30x32 mm	23,52	5	6M-30-32
30x36 mm	39,16	5	6M-30-36
32x36 mm	41,17	5	6M-32-36
34x36 mm	43,22	1	6M-34-36
36x41 mm	46,93	1	6M-36-41
38x42 mm	55,80	1	6M-38-42
41x46 mm	66,05	1	6M-41-46
46x50 mm	86,11	1	6M-46-50
4x5 mm	9,59	1	SB6M-4-5
6x7 mm	8,06	1	SB6M-6-7
8x9 mm	7,50	1	SB6M-8-9
10x11 mm	7,97	1	SB6M-10-11
12x13 mm	9,08	1	SB6M-12-13
14x15 mm	9,54	1	SB6M-14-15
16x17 mm	10,57	1	SB6M-16-17
17x19 mm	11,22	1	SB6M-17-19
18x19 mm	11,34	1	SB6M-18-19
20x22 mm	13,60	1	SB6M-20-22
21x23 mm	14,71	1	SB6M-21-23
22x24 mm	14,11	1	SB6M-22-24
24x26 mm	16,72	1	SB6M-24-26
24x27 mm	17,02	1	SB6M-24-27
25x28 mm	18,10	1	SB6M-25-28
27x29 mm	22,00	1	SB6M-27-29
30x32 mm	24,56	1	SB6M-30-32

SB- con clip para colgar

Llave fija de dos bocas, pulgadas



6Z

	€		
1/4x5/16 in	5,59	5	6Z-1/4-5/16
5/16x11/32 in	5,59	5	6Z-5/16-11/32
3/8x7/16 in	6,25	5	6Z-3/8-7/16
7/16x1/2 in	7,47	5	6Z-7/16-1/2
1/2x9/16 in	7,91	5	6Z-1/2-9/16
9/16x5/8 in	7,91	5	6Z-9/16-5/8
19/32x11/16 in	9,92	5	6Z-19/32-11/16
5/8x3/4 in	10,30	5	6Z-5/8-3/4
11/16x3/4 in	10,30	5	6Z-11/16-3/4
3/4x7/8 in	12,28	5	6Z-3/4-7/8
25/32x13/16 in	14,18	5	6Z-25/32-13/16
13/16x7/8 in	12,28	5	6Z-13/16-7/8
7/8x15/16 in	15,88	5	6Z-7/8-15/16
15/16x1 in	15,53	5	6Z-15/16-1
1x1.1/8 in	17,99	1	6Z-1-1.1/8
1.1/16x1.1/4 in	23,83	1	6Z-1.1/16-1.1/4
1.1/4x1.3/8 in	41,36	1	6Z-1.1/4-1.3/8

Llave fija de dos bocas, Liliput pulgadas



1931Z

	L	€		
1/8 in	74 mm	15,52	5	1931Z-1/8
5/32 in	80 mm	10,06	5	1931Z-5/32
3/16 in	80 mm	10,06	5	1931Z-3/16
13/64 in	80 mm	10,06	5	1931Z-13/64
7/32 in	80 mm	10,06	5	1931Z-7/32
15/64x1/4 in	84 mm	17,35	5	1931Z-15/64-1/4
1/4 in	80 mm	10,06	5	1931Z-1/4
9/32 in	90 mm	10,48	5	1931Z-9/32
9/32x5/16 in	94 mm	16,37	5	1931Z-9/32-5/16
5/16 in	90 mm	11,33	5	1931Z-5/16
11/32 in	105 mm	11,75	5	1931Z-11/32
11/32x3/8 in	94 mm	18,45	5	1931Z-11/32-3/8
3/8 in	105 mm	12,17	5	1931Z-3/8
7/16 in	120 mm	12,99	5	1931Z-7/16
1/2 in	120 mm	12,99	5	1931Z-1/2
9/16 in	130 mm	13,85	5	1931Z-9/16
5/8 in	130 mm	15,92	5	1931Z-5/8

Juego de 8 llaves fijas, mm



6M/SH

	€		
8	78,45	1	6M/SH8

6M-6-7, 6M-8-9, 6M-10-11, 6M-12-13, 6M-14-15, 6M-16-17, 6M-18-19, 6M-20-22

Juego de 12 llaves fijas, mm



6M/SH12

	€		
12	144,95	1	6M/SH12

6M-6-7, 6M-8-9, 6M-10-11, 6M-12-13, 6M-14-15, 6M-16-17, 6M-18-19, 6M-20-22, 6M-21-23, 6M-24-26, 6M-25-28, 6M-30-32

Llave fija de dos bocas, Liliput mm



1931M

	€		
4 mm	9,65	5	1931M-4
4.5 mm	9,65	5	1931M-4.5
5 mm	9,65	5	1931M-5
5.5 mm	9,65	5	1931M-5.5
6 mm	9,65	5	1931M-6
7 mm	9,65	5	1931M-7
8 mm	10,06	5	1931M-8
9 mm	10,90	5	1931M-9
10 mm	11,33	5	1931M-10
11 mm	12,17	5	1931M-11
12 mm	12,17	5	1931M-12
13 mm	12,17	5	1931M-13
14 mm	12,99	5	1931M-14
17 mm	17,19	5	1931M-17

Llave fija DIN895 de dos bocas, mm



895M

	L	€		
6x7 mm	96 mm	3,47	10	895M-6-7
8x9 mm	109 mm	3,14	10	895M-8-9
8x10 mm	115 mm	3,14	10	895M-8-10
10x11 mm	124 mm	3,43	10	895M-10-11
10x13 mm	110 mm	3,43	10	895M-10-13
13x17 mm	155 mm	4,12	10	895M-13-17
17x19 mm	172 mm	5,08	10	895M-17-19
19x22 mm	195 mm	6,22	10	895M-19-22
19x24 mm	206 mm	7,12	5	895M-19-24
22x24 mm	220 mm	7,46	5	895M-22-24
24x27 mm	244 mm	9,89	5	895M-24-27
24x30 mm	265 mm	11,74	5	895M-24-30
27x32 mm	270 mm	14,20	5	895M-27-32
30x32 mm	275 mm	14,95	5	895M-30-32
30x36 mm	305 mm	20,02	1	895M-30-36
32x36 mm	307 mm	20,02	1	895M-32-36
36x41 mm	345 mm	27,73	1	895M-36-41
41x46 mm	381 mm	33,74	1	895M-41-46
46x50 mm	420 mm	40,54	1	895M-46-50
50x55 mm	460 mm	53,45	1	895M-50-55
55x60 mm	500 mm	67,42	1	895M-55-60
65x70 mm	580 mm	132,69	1	895M-65-70

Juego de 8 llaves fijas de dos bocas, mm



6M/S

	€		
8	63,08	1	6M/S8

6M-6-7, 6M-8-9, 6M-10-11, 6M-12-13, 6M-14-15, 6M-16-17, 6M-18-19, 6M-20-22



Juego de 6 llaves fijas en clip, mm



6M/

	€		
6	41,81	1	6M/6C

6M-6-7, 6M-8-9, 6M-10-11, 6M-12-13, 6M-14-15, 6M-16-17

Juego de 8 llaves fijas en clip, mm



6M/8C

	€		
8	64,30	1	6M/8C

6M-6-7, 6M-8-9, 6M-10-11, 6M-12-13, 6M-14-15, 6M-16-17, 6M-18-19, 6M-20-22

Juego de 10 llaves fijas en clip, mm



6M/10C

	€		
10	93,07	1	6M/10C

6M-6-7, 6M-8-9, 6M-10-11, 6M-12-13, 6M-14-15, 6M-16-17, 6M-18-19, 6M-20-22, 6M-24-27, 6M-30-32

Juego de 12 llaves fijas en clip, mm



6M/12C

	€		
12	135,38	1	6M/12C

6M-6-7, 6M-8-9, 6M-10-11, 6M-12-13, 6M-14-15, 6M-16-17, 6M-18-19, 6M-20-22, 6M-21-23, 6M-24-27, 6M-25-28, 6M-30-32

Juego de 8 llaves fijas de dos bocas, pulgadas



6Z/

	€		
8	74,83	1	6Z/8C

6Z-1/4-5/16, 6Z-3/8-7/16, 6Z-5/16-11/32, 6Z-1/2-9/16, 6Z-19/32-11/16, 6Z-5/8-3/4, 6Z-13/16-7/8, 6Z-15/16-1

Juego de 10 llaves fijas de dos bocas, Liliput



1931M/

	€		
10	108,60	1	1931M/10T

1931M-4, 1931M-4.5, 1931M-5, 1931M-5.5, 1931M-6, 1931M-7, 1931M-8, 1931M-9, 1931M-10, 1931M-11

Juego de 12 llaves fijas de dos bocas, Liliput



1931Z/

	€		
12	140,40	1	1931Z/12T

1931Z-5/32, 1931Z-9/32, 1931Z-5/16, 1931Z-11/32, 1931Z-3/8, 1931Z-3/16, 1931Z-7/32, 1931Z-1/4, 1931Z-7/16, 1931Z-1/2, 1931Z-5/8, 1931Z-9/16

Juego de 6 llaves fijas de dos bocas para electrónica



1933M/

	€		
6	58,57	1	1933M/6T

4x4, 4.5x4.5, 5x5, 5.5x5.5, 6x6, 7x7

Llave magneto en anillo



3280M/

	€		
8	16,96	1	3280M

4, 4.5, 5, 5.5, 6, 6.5, 7, 7.5 mm

Llave fija Crowfoot 1/4"



677-

Icon	Icon	€	Icon	Icon
7 mm	1/4 in	32,63	1	677-7
8 mm	1/4 in	32,63	1	677-8
9 mm	1/4 in	32,63	1	677-9
10 mm	1/4 in	32,63	1	677-10
13 mm	1/4 in	32,63	1	677-13
3/8 in	1/4 in	32,28	1	677-3/8

Llave fija Crowfoot 3/8"



747-

Icon	Icon	€	Icon	Icon
10 mm	3/8 in	32,81	1	747-10
11 mm	3/8 in	34,30	1	747-11
12 mm	3/8 in	31,79	1	747-12
13 mm	3/8 in	31,79	1	747-13
14 mm	3/8 in	29,53	1	747-14
15 mm	3/8 in	37,87	1	747-15
16 mm	3/8 in	38,57	1	747-16
17 mm	3/8 in	35,61	1	747-17
18 mm	3/8 in	41,91	1	747-18
19 mm	3/8 in	35,61	1	747-19
20 mm	3/8 in	48,12	1	747-20
21 mm	3/8 in	48,12	1	747-21
22 mm	3/8 in	48,12	1	747-22
23 mm	3/8 in	48,70	1	747-23
24 mm	3/8 in	49,18	1	747-24
25 mm	3/8 in	49,48	1	747-25
26 mm	3/8 in	49,90	1	747-26
27 mm	3/8 in	48,70	1	747-27
28 mm	3/8 in	52,75	1	747-28
30 mm	3/8 in	48,70	1	747-30
32 mm	3/8 in	48,70	1	747-32
34 mm	3/8 in	53,12	1	747-34
36 mm	3/8 in	60,14	1	747-36
40 mm	3/8 in	74,43	1	747-40
41 mm	3/8 in	86,93	1	747-41
42 mm	3/8 in	86,93	1	747-42
46 mm	3/8 in	103,00	1	747-46

Icon	Icon	€	Icon	Icon
50 mm	3/8 in	103,00	1	747-50
3/8 in	3/8 in	31,57	1	747-3/8
7/16 in	3/8 in	32,97	1	747-7/16
1/2 in	3/8 in	32,28	1	747-1/2
9/16 in	3/8 in	32,29	1	747-9/16
5/8 in	3/8 in	38,47	1	747-5/8
11/16 in	3/8 in	38,47	1	747-11/16
3/4 in	3/8 in	38,47	1	747-3/4
13/16 in	3/8 in	41,91	1	747-13/16
7/8 in	3/8 in	48,70	1	747-7/8
15/16 in	3/8 in	48,70	1	747-15/16
1 in	3/8 in	48,70	1	747-1
1.1/16 in	3/8 in	48,70	1	747-1.1/16
1.1/8 in	3/8 in	46,92	1	747-1.1/8
1.3/16 in	3/8 in	48,70	1	747-1.3/16
1.1/4 in	3/8 in	48,70	1	747-1.1/4
1.5/16 in	3/8 in	49,90	1	747-1.5/16
1.3/8 in	3/8 in	48,70	1	747-1.3/8
1.7/16 in	3/8 in	60,14	1	747-1.7/16
1.1/2 in	3/8 in	60,14	1	747-1.1/2
1.9/16 in	3/8 in	61,94	1	747-1.9/16
1.5/8 in	3/8 in	80,97	1	747-1.5/8
1.11/16 in	3/8 in	85,15	1	747-1.11/16
1.3/4 in	3/8 in	89,91	1	747-1.3/4
1.13/16 in	3/8 in	97,64	1	747-1.13/16
1.7/8 in	3/8 in	97,64	1	747-1.7/8
1.15/16 in	3/8 in	97,73	1	747-1.15/16
2 in	3/8 in	100,62	1	747-2
2.1/16 in	3/8 in	102,18	1	747-2.1/16
2.1/8 in	3/8 in	129,79	1	747-2.1/8
2.3/16 in	3/8 in	133,36	1	747-2.3/16
2.1/4 in	3/8 in	133,36	1	747-2.1/4
2.5/16 in	3/8 in	133,36	1	747-2.5/16
2.3/8 in	3/8 in	140,17	1	747-2.3/8
2.7/16 in	3/8 in	149,81	1	747-2.7/16
2.1/2 in	3/8 in	149,81	1	747-2.1/2
2.9/16 in	3/8 in	149,81	1	747-2.9/16
2.5/8 in	3/8 in	156,11	1	747-2.5/8
2.3/4 in	3/8 in	156,11	1	747-2.3/4
2.7/8 in	3/8 in	195,77	1	747-2.7/8

Llave fija Crowfoot 1/2"



787-

Icon	Icon	€	Icon	Icon
1.1/16 in	1/2 in	48,70	1	787-1.1/16
1.1/8 in	1/2 in	48,70	1	787-1.1/8
1.3/16 in	1/2 in	54,63	1	787-1.3/16
1.1/4 in	1/2 in	54,63	1	787-1.1/4
1.5/16 in	1/2 in	54,63	1	787-1.5/16
1.3/8 in	1/2 in	59,40	1	787-1.3/8
1.7/16 in	1/2 in	60,59	1	787-1.7/16
1.1/2 in	1/2 in	61,20	1	787-1.1/2
1.5/8 in	1/2 in	67,13	1	787-1.5/8
1.11/16 in	1/2 in	136,67	1	787-1.11/16
1.3/4 in	1/2 in	136,67	1	787-1.3/4

Icon	Icon	€	Icon	Icon
1.13/16 in	1/2 in	136,67	1	787-1.13/16
1.7/8 in	1/2 in	148,54	1	787-1.7/8
2 in	1/2 in	148,54	1	787-2
2.1/8 in	1/2 in	166,31	1	787-2.1/8
2.3/16 in	1/2 in	166,31	1	787-2.3/16
2.1/4 in	1/2 in	178,16	1	787-2.1/4
2.3/8 in	1/2 in	190,11	1	787-2.3/8

Llave fija DIN894 de una boca



894M

Icon	L	€	Icon	Icon
7 mm	78 mm	3,43	10	894M-7
8 mm	94 mm	3,43	10	894M-8
9 mm	100 mm	3,52	10	894M-9
10 mm	106 mm	3,43	10	894M-10
11 mm	112 mm	3,52	10	894M-11
12 mm	125 mm	3,52	10	894M-12
13 mm	125 mm	3,52	10	894M-13
14 mm	140 mm	4,12	10	894M-14
15 mm	140 mm	4,27	10	894M-15
16 mm	140 mm	4,56	10	894M-16
17 mm	158 mm	3,52	10	894M-17
19 mm	171 mm	4,78	10	894M-19
21 mm	195 mm	5,14	5	894M-21
22 mm	195 mm	5,95	5	894M-22
24 mm	216 mm	7,17	5	894M-24
27 mm	240 mm	8,19	5	894M-27
30 mm	262 mm	9,65	5	894M-30
32 mm	274 mm	10,88	5	894M-32
34 mm	274 mm	18,09	1	894M-34
36 mm	303 mm	14,15	5	894M-36
38 mm	305 mm	22,06	1	894M-38
41 mm	343 mm	22,45	1	894M-41
46 mm	378 mm	25,40	1	894M-46
50 mm	413 mm	31,81	1	894M-50
55 mm	457 mm	37,58	1	894M-55
60 mm	492 mm	52,96	1	894M-60
65 mm	528 mm	63,53	1	894M-65
70 mm	573 mm	74,20	1	894M-70
75 mm	608 mm	127,79	1	894M-75
80 mm	644 mm	150,86	1	894M-80
85 mm	690 mm	184,14	1	894M-85
90 mm	690 mm	205,94	1	894M-90
95 mm	850 mm	313,27	1	894M-95
100 mm	1000 mm	319,36	1	894M-100
105 mm	1000 mm	417,14	1	894M-105
110 mm	1000 mm	466,12	1	894M-110
115 mm	1000 mm	528,69	1	894M-115
120 mm	1000 mm	556,07	1	894M-120
125 mm	1000 mm	641,65	1	894M-125
130 mm	1000 mm	664,74	1	894M-130
135 mm	1000 mm	745,28	1	894M-135



Llave podger acodada de tareas pesadas abierta, en mm



SC335M

Wrench Size	Length (L)	Price (€)	Quantity	Code
17 mm	320 mm	10,17	1	SC335M-17
19 mm	350 mm	14,78	1	SC335M-19
22 mm	350 mm	19,95	1	SC335M-22
24 mm	370 mm	21,76	1	SC335M-24
27 mm	370 mm	29,65	1	SC335M-27
30 mm	400 mm	37,05	1	SC335M-30
32 mm	400 mm	37,96	1	SC335M-32
36 mm	430 mm	43,13	1	SC335M-36
41 mm	470 mm	58,34	1	SC335M-41
46 mm	500 mm	73,63	1	SC335M-46

LLAVES DE ESTRELLA DE DOS Bocas

Llave de estrella acodada, mm



2M

Wrench Size	Length (L)	Price (€)	Quantity	Code
6x7 mm	165 mm	10,38	5	2M-6-7
8x9 mm	180 mm	11,37	5	2M-8-9
8x10 mm	180 mm	13,18	5	2M-8-10
10x11 mm	190 mm	12,03	5	2M-10-11
10x13 mm	190 mm	15,25	5	2M-10-13
12x13 mm	210 mm	12,93	5	2M-12-13
13x17 mm	243 mm	14,11	5	2M-13-17
14x15 mm	226 mm	13,71	5	2M-14-15
16x17 mm	246 mm	16,38	5	2M-16-17
16x18 mm	246 mm	19,57	5	2M-16-18
17x19 mm	266 mm	19,09	5	2M-17-19
18x19 mm	266 mm	19,09	5	2M-18-19
19x22 mm	291 mm	22,57	5	2M-19-22
20x22 mm	291 mm	23,42	5	2M-20-22
21x23 mm	306 mm	25,00	5	2M-21-23
22x24 mm	306 mm	27,27	5	2M-22-24
24x26 mm	326 mm	30,90	5	2M-24-26
24x27 mm	326 mm	31,38	5	2M-24-27
25x28 mm	336 mm	36,04	5	2M-25-28
27x29 mm	351 mm	37,07	5	2M-27-29
27x30 mm	351 mm	44,08	5	2M-27-30
27x32 mm	353 mm	44,08	5	2M-27-32

Wrench Size	Length (L)	Price (€)	Quantity	Code
30x32 mm	362 mm	43,95	5	2M-30-32
32x36 mm	402 mm	64,57	1	2M-32-36
36x41 mm	438 mm	76,69	1	2M-36-41
41x46 mm	485 mm	101,37	1	2M-41-46
46x50 mm	535 mm	125,12	1	2M-46-50

Llave doble de estrella, extra acodada



ZZ

Wrench Size	Length (L)	Price (€)	Quantity	Code
1/4x5/16 in	165 mm	11,85	1	ZZ-1/4-5/16
5/16x3/8 in	180 mm	11,58	1	ZZ-5/16-3/8
3/8x7/16 in	190 mm	13,25	1	ZZ-3/8-7/16
1/2x9/16 in	210 mm	13,15	1	ZZ-1/2-9/16
9/16x5/8 in	225.8 mm	14,11	1	ZZ-9/16-5/8
5/8x11/16 in	245.5 mm	16,81	1	ZZ-5/8-11/16
3/4x7/8 in	290.5 mm	22,57	1	ZZ-3/4-7/8
13/16x7/8 in	290.5 mm	22,57	1	ZZ-13/16-7/8
15/16x1 in	325.8 mm	31,08	1	ZZ-15/16-1
1x1 1/8 in	335.9 mm	36,83	1	ZZ-1-1.1/8
1 1/16x1 1/4 in	353 mm	40,75	1	ZZ-1.1/16-1.1/4

Llave de estrella de dos bocas acodada, pulgadas



1300Z

Wrench Size	Length (L)	Price (€)	Quantity	Code
1/4x5/16 in	156 mm	26,56	1	1300Z-1/4-5/16
3/8x7/16 in	193 mm	26,56	1	1300Z-3/8-7/16
1/2x9/16 in	220 mm	29,18	1	1300Z-1/2-9/16
19/32x11/16 in	258 mm	33,64	1	1300Z-19/32-11/16
5/8x3/4 in	278 mm	35,83	1	1300Z-5/8-3/4
25/32x13/16 in	300 mm	49,52	1	1300Z-25/32-13/16
7/8x15/16 in	334 mm	41,01	1	1300Z-7/8-15/16
15/16x1 in	352 mm	53,43	1	1300Z-15/16-1
1x1.1/8 in	380 mm	69,67	1	1300Z-1-1.1/8

Juego de 8 llaves de estrella de dos bocas extra-acodadas, mm



2M/S

Wrench Size	Price (€)	Quantity	Code
8	117,86	1	2M/S8

2M-6-7, 2M-8-9, 2M-10-11, 2M-12-13, 2M-14-15, 2M-16-17, 2M-18-19, 2M-20-22

Juego de 8 llaves de estrella de dos bocas extra-acodadas, mm



2M/T

Wrench Size	Price (€)	Quantity	Code
8	122,05	1	2M/8T

2M-6-7, 2M-8-9, 2M-10-11, 2M-12-13, 2M-14-15, 2M-16-17, 2M-18-19, 2M-20-22

Juego de 10 llaves de estrella de dos bocas acodadas, mm



2M/10T

Wrench Size	Price (€)	Quantity	Code
10	180,51	1	2M/10T

2M-6-7, 2M-8-9, 2M-10-11, 2M-12-13, 2M-14-15, 2M-16-17, 2M-18-19, 2M-20-22, 2M-21-23, 2M-24-27

Juego de 12 llaves de estrella de dos bocas acodadas, mm



2M/12T

Icon	€	Box	Icon
	259,43	1	2M/12T

2M-6-7, 2M-8-9, 2M-10-11, 2M-12-13, 2M-14-15, 2M-16-17, 2M-18-19, 2M-20-22, 2M-21-23, 2M-24-27, 2M-25-28, 2M-30-32

Juego de 7 llaves estrella acodada dos bocas, pulgadas



2Z/7T

Icon	€	Box	Icon
	108,23	1	2Z/7T

2Z-1/4-5/16, 2Z-5/16-3/8, 2Z-3/8-7/16, 2Z-1/2-9/16, 2Z-9/16-5/8, 2Z-5/8-11/16, 2Z-3/4-7/8

Llave de estrella plana de dos bocas, mm



4M

Icon	L	€	Box	Icon
	95 mm	9,75	10	4M-6-7
	110 mm	10,07	10	4M-8-9
	125 mm	11,19	10	4M-10-11

Icon	L	€	Box	Icon
	140 mm	12,23	10	4M-12-13
	155 mm	13,41	10	4M-14-15
	170 mm	14,42	10	4M-16-17
	170 mm	14,99	10	4M-17-19
	185 mm	14,99	10	4M-18-19
	205 mm	17,31	10	4M-20-22
	225 mm	18,96	5	4M-21-23
	250 mm	21,27	1	4M-24-26
	255 mm	21,27	1	4M-24-27
	275 mm	24,03	1	4M-25-28
	275 mm	28,83	1	4M-27-29
	300 mm	30,30	1	4M-30-32

Llave de estrella de dos bocas larga, pulgadas



44Z

Icon	L	€	Box	Icon
	197 mm	21,36	10	44Z-1/4-5/16
	238 mm	21,36	10	44Z-5/16-3/8
	284 mm	24,61	10	44Z-3/8-7/16
	326 mm	28,55	10	44Z-7/16-1/2
	358 mm	33,89	10	44Z-1/2-9/16
	401 mm	41,94	5	44Z-5/8-3/4
	401 mm	41,94	5	44Z-11/16-3/4
	410 mm	52,62	5	44Z-11/16-13/16

Llave de estrella de media luna, mm



1943M

Icon	L	€	Box	Icon
	150 mm	27,99	1	1943M-11-13
	185 mm	29,82	1	1943M-13-15
	185 mm	31,48	1	1943M-13-17
	185 mm	32,09	1	1943M-14-17
	185 mm	32,41	1	1943M-15-17
	235 mm	34,34	1	1943M-19-22

Llave de estrella de media luna, pulgadas



1943Z

Icon	L	€	Box	Icon
	153 mm	30,52	1	1943Z-5/16-3/8
	153 mm	30,52	1	1943Z-7/16-1/2
	186 mm	32,00	1	1943Z-9/16-5/8
	233 mm	32,00	1	1943Z-5/8-3/4
	233 mm	35,92	1	1943Z-11/16-13/16

Juego de 10 llaves de estrella plana de dos bocas, mm



4M/10T

Icon	€	Box	Icon
	178,83	1	4M/10T

4M-6-7, 4M-8-9, 4M-10-11, 4M-12-13, 4M-14-15, 4M-16-17, 4M-18-19, 4M-20-22, 4M-24-27, 4M-30-32

Juego de 10 llaves de estrella plana de dos bocas, mm



4M/C

Icon	€	Box	Icon
	161,00	1	4M/10C

4M-6-7, 4M-8-9, 4M-10-11, 4M-12-13, 4M-14-15, 4M-16-17, 4M-18-19, 4M-20-22, 4M-21-23, 4M-24-27



Juego de 12 llaves estrella plana, mm



4M/12C

Icon	€	Icon	Icon
12	216,17	1	4M/12C

4M-6-7, 4M-8-9, 4M-10-11, 4M-12-13, 4M-14-15, 4M-16-17, 4M-18-19, 4M-20-22, 4M-21-23, 4M-24-27, 4M-25-28, 4M-30-32

Juego de 8 llaves planas de dos bocas, mm



4M/

Icon	€	Icon	Icon
8	120,17	1	4M/8

4M-6-7, 4M-8-9, 4M-10-11, 4M-12-13, 4M-14-15, 4M-16-17, 4M-18-19, 4M-20-22

LLAVES PARA RACORES

Llave para racores dos bocas, mm



1949M

Icon	L	€	Icon	Icon
8x 9 mm	140 mm	23,21	1	1949M-8-9
10x11 mm	150 mm	23,21	1	1949M-10-11
10x12 mm	150 mm	24,09	1	1949M-10-12

Icon	L	€	Icon	Icon
12x13 mm	170 mm	24,81	1	1949M-12-13
12x14 mm	170 mm	26,03	1	1949M-12-14
14x15 mm	170 mm	26,03	1	1949M-14-15
14x17 mm	200 mm	26,03	1	1949M-14-17
17x19 mm	210 mm	35,57	1	1949M-17-19
19x22 mm	220 mm	35,57	1	1949M-19-22
22x24 mm	235 mm	40,71	1	1949M-22-24
24x27 mm	255 mm	51,46	1	1949M-24-27
30x32 mm	280 mm	63,70	1	1949M-30-32

Llaves para racores, dos bocas, pulgadas



1949Z

Icon	L	€	Icon	Icon
3/8x7/16 in	150 mm	25,01	1	1949Z-3/8-7/16
1/2x9/16 in	170 mm	28,08	1	1949Z-1/2-9/16
5/8x3/4 in	210 mm	31,46	1	1949Z-5/8-3/4
3/4x7/8 in	220 mm	33,95	1	1949Z-3/4-7/8
1x1 1/8 in	255 mm	56,66	1	1949Z-1-1.1/8

Llave Crowfoot 1/4", para racores



679-

Icon	Icon	€	Icon	Icon
7 mm	1/4 in	45,02	1	679-7
8 mm	1/4 in	45,02	1	679-8
9 mm	1/4 in	45,97	1	679-9
10 mm	1/4 in	50,06	1	679-10
11 mm	1/4 in	45,02	1	679-11
12 mm	1/4 in	50,47	1	679-12
13 mm	1/4 in	50,71	1	679-13
14 mm	1/4 in	54,60	1	679-14
3/8 in	1/4 in	42,86	1	679-3/8
7/16 in	1/4 in	42,86	1	679-7/16
1/2 in	1/4 in	42,86	1	679-1/2
9/16 in	1/4 in	42,86	1	679-9/16

Llave Crowfoot 3/8", para racores



749-

Icon	Icon	€	Icon	Icon
10 mm	3/8 in	15,66	10	749-10
11 mm	3/8 in	15,66	10	749-11
13 mm	3/8 in	4,53	10	749-13
14 mm	3/8 in	17,00	10	749-14
15 mm	3/8 in	57,76	1	749-15
16 mm	3/8 in	51,20	1	749-16
17 mm	3/8 in	64,45	1	749-17
18 mm	3/8 in	51,20	1	749-18
19 mm	3/8 in	64,45	1	749-19
20 mm	3/8 in	53,58	1	749-20
21 mm	3/8 in	65,78	1	749-21
22 mm	3/8 in	65,78	1	749-22
23 mm	3/8 in	58,95	1	749-23
24 mm	3/8 in	59,72	1	749-24
25 mm	3/8 in	60,14	1	749-25
26 mm	3/8 in	74,51	1	749-26
27 mm	3/8 in	73,51	1	749-27
3/8 in	3/8 in	50,00	1	749-3/8
7/16 in	3/8 in	50,00	1	749-7/16
1/2 in	3/8 in	50,91	1	749-1/2
9/16 in	3/8 in	53,73	1	749-9/16
5/8 in	3/8 in	53,95	1	749-5/8
11/16 in	3/8 in	53,95	1	749-11/16
3/4 in	3/8 in	53,95	1	749-3/4
13/16 in	3/8 in	53,95	1	749-13/16
7/8 in	3/8 in	53,46	1	749-7/8
15/16 in	3/8 in	54,78	1	749-15/16
1 in	3/8 in	54,78	1	749-1
1.1/16 in	3/8 in	54,78	1	749-1.1/16
1.1/8 in	3/8 in	54,78	1	749-1.1/8
1.3/16 in	3/8 in	59,87	1	749-1.3/16
1.1/4 in	3/8 in	63,21	1	749-1.1/4
1.5/16 in	3/8 in	81,86	1	749-1.5/16
1.3/8 in	3/8 in	84,70	1	749-1.3/8
1.7/16 in	3/8 in	86,37	1	749-1.7/16
1.1/2 in	3/8 in	100,50	1	749-1.1/2
1.9/16 in	3/8 in	102,49	1	749-1.9/16
1.5/8 in	3/8 in	106,71	1	749-1.5/8
1.11/16 in	3/8 in	106,71	1	749-1.11/16
1.3/4 in	3/8 in	120,52	1	749-1.3/4
1.13/16 in	3/8 in	123,63	1	749-1.13/16
1.7/8 in	3/8 in	123,63	1	749-1.7/8
1.15/16 in	3/8 in	132,68	1	749-1.15/16
2 in	3/8 in	137,20	1	749-2
2.1/8 in	3/8 in	143,40	1	749-2.1/8
2.3/16 in	3/8 in	143,40	1	749-2.3/16
2.1/4 in	3/8 in	143,40	1	749-2.1/4
2.3/8 in	3/8 in	150,20	1	749-2.3/8
2.5/8 in	3/8 in	167,69	1	749-2.5/8
2.3/4 in	3/8 in	167,69	1	749-2.3/4
3.1/8 in	3/8 in	239,94	1	749-3.1/8

Llave Crowfoot 1/2", para racores



789-

mm	in	€	1	789-XX
28 mm	1/2 in	63,12	1	789-28
30 mm	1/2 in	80,13	1	789-30
32 mm	1/2 in	84,14	1	789-32
34 mm	1/2 in	67,87	1	789-34
36 mm	1/2 in	90,84	1	789-36
38 mm	1/2 in	75,02	1	789-38
40 mm	1/2 in	84,55	1	789-40
41 mm	1/2 in	111,02	1	789-41
42 mm	1/2 in	84,55	1	789-42
46 mm	1/2 in	123,58	1	789-46
50 mm	1/2 in	110,15	1	789-50
1.1/8 in	1/2 in	54,78	1	789-1.1/8
1.1/4 in	1/2 in	59,54	1	789-1.1/4
1.5/16 in	1/2 in	63,12	1	789-1.5/16
1.3/8 in	1/2 in	63,12	1	789-1.3/8
1.7/16 in	1/2 in	68,47	1	789-1.7/16
1.1/2 in	1/2 in	68,47	1	789-1.1/2
1.9/16 in	1/2 in	78,58	1	789-1.9/16
1.5/8 in	1/2 in	78,58	1	789-1.5/8
1.3/4 in	1/2 in	91,08	1	789-1.3/4
1.13/16 in	1/2 in	91,08	1	789-1.13/16
2 in	1/2 in	98,83	1	789-2
2.1/4 in	1/2 in	110,75	1	789-2.1/4
2.5/16 in	1/2 in	133,36	1	789-2.5/16
2.3/8 in	1/2 in	138,13	1	789-2.3/8

Llave Crowfoot 3/8", ajustable



1950MZ

mm	in	€	1	1950MZ-XX
0-29/0-1.1/8 in		77,02	1	1950MZ-3/8

LLAVES DE GOLPEO

Llave de estrella de golpeo, mm



7444SG-M

mm	€	1	7444SG-M-XX
24 mm	36,28	1	7444SG-M-24
27 mm	39,46	1	7444SG-M-27
30 mm	40,66	1	7444SG-M-30
32 mm	40,66	1	7444SG-M-32
34 mm	59,56	1	7444SG-M-34
36 mm	51,91	1	7444SG-M-36
38 mm	61,09	1	7444SG-M-38
41 mm	66,28	1	7444SG-M-41
42 mm	66,28	1	7444SG-M-42
46 mm	72,64	1	7444SG-M-46
50 mm	81,67	1	7444SG-M-50
55 mm	93,40	1	7444SG-M-55
60 mm	98,45	1	7444SG-M-60
65 mm	131,94	1	7444SG-M-65
70 mm	152,58	1	7444SG-M-70
75 mm	163,84	1	7444SG-M-75
80 mm	217,98	1	7444SG-M-80
85 mm	291,91	1	7444SG-M-85
90 mm	381,65	1	7444SG-M-90
95 mm	421,68	1	7444SG-M-95
100 mm	474,87	1	7444SG-M-100
105 mm	535,71	1	7444SG-M-105
110 mm	590,67	1	7444SG-M-110
115 mm	679,84	1	7444SG-M-115
120 mm	989,69	1	7444SG-M-120
125 mm	1.280,31	1	7444SG-M-125
130 mm	1.392,43	1	7444SG-M-130
135 mm	1.436,30	1	7444SG-M-135
140 mm	1.628,91	1	7444SG-M-140
145 mm	2.261,60	1	7444SG-M-145
150 mm	2.380,87	1	7444SG-M-150
155 mm	2.585,00	1	7444SG-M-155
160 mm	2.739,29	1	7444SG-M-160
165 mm	2.909,95	1	7444SG-M-165
170 mm	3.198,45	1	7444SG-M-170
175 mm	3.431,08	1	7444SG-M-175

Llave de estrella de golpeo, pulgadas



7444SG-Z

in	€	1	7444SG-Z-XX
1 1/16 in	43,41	1	7444SG-Z-1.1/16
1 1/8 in	44,73	1	7444SG-Z-1.1/8
1 3/16 in	44,73	1	7444SG-Z-1.3/16

in	€	1	7444SG-Z-XX
1 1/4 in	44,73	1	7444SG-Z-1.1/4
1 5/16 in	65,54	1	7444SG-Z-1.5/16
1 3/8 in	65,54	1	7444SG-Z-1.3/8
1 7/16 in	65,54	1	7444SG-Z-1.7/16
1 1/2 in	67,19	1	7444SG-Z-1.1/2
1 5/8 in	72,90	1	7444SG-Z-1.5/8
1 11/16 in	72,90	1	7444SG-Z-1.11/16
1 3/4 in	79,91	1	7444SG-Z-1.3/4
1 13/16 in	79,91	1	7444SG-Z-1.13/16
1 7/8 in	89,83	1	7444SG-Z-1.7/8
2 in	89,83	1	7444SG-Z-2
2 1/16 in	102,75	1	7444SG-Z-2.1/16
2 1/8 in	108,32	1	7444SG-Z-2.1/8
2 3/16 in	108,32	1	7444SG-Z-2.3/16
2 1/4 in	108,32	1	7444SG-Z-2.1/4
2 3/8 in	133,79	1	7444SG-Z-2.3/8
2 9/16 in	167,85	1	7444SG-Z-2.9/16
2 5/8 in	167,85	1	7444SG-Z-2.5/8
2 3/4 in	167,85	1	7444SG-Z-2.3/4
3 in	180,23	1	7444SG-Z-3
3 1/8 in	285,36	1	7444SG-Z-3.1/8
3 3/8 in	321,10	1	7444SG-Z-3.3/8
3 1/2 in	419,82	1	7444SG-Z-3.1/2
3 3/4 in	463,86	1	7444SG-Z-3.3/4
3 7/8 in	522,38	1	7444SG-Z-3.7/8
4 in	589,27	1	7444SG-Z-4
4 1/8 in	589,27	1	7444SG-Z-4.1/8
4 1/2 in	747,83	1	7444SG-Z-4.1/2

Llave fija de golpeo, mm



133SGM

mm	€	1	133SGM-XX
27 mm	28,92	1	133SGM-27
30 mm	33,95	1	133SGM-30
32 mm	36,01	1	133SGM-32
36 mm	46,40	1	133SGM-36
41 mm	56,88	1	133SGM-41
46 mm	76,60	1	133SGM-46
50 mm	87,27	1	133SGM-50
55 mm	101,79	1	133SGM-55
60 mm	113,12	1	133SGM-60
65 mm	141,75	1	133SGM-65
70 mm	182,61	1	133SGM-70
75 mm	195,53	1	133SGM-75
80 mm	255,35	1	133SGM-80
85 mm	268,27	1	133SGM-85
90 mm	342,57	1	133SGM-90
95 mm	360,37	1	133SGM-95
100 mm	552,66	1	133SGM-100
105 mm	617,31	1	133SGM-105
110 mm	673,88	1	133SGM-110
115 mm	788,62	1	133SGM-115
120 mm	801,55	1	133SGM-120



Llave de estrella de impacto extra-acodada, mm



315M

	€		
27 mm	75,44	1	315M-27
30 mm	76,87	1	315M-30
32 mm	75,44	1	315M-32
36 mm	104,43	1	315M-36
41 mm	107,36	1	315M-41
46 mm	139,28	1	315M-46
50 mm	156,67	1	315M-50
55 mm	179,89	1	315M-55
60 mm	232,10	1	315M-60
65 mm	264,01	1	315M-65
70 mm	307,54	1	315M-70
75 mm	319,16	1	315M-75
80 mm	368,46	1	315M-80

Llave de estrella de impacto extra-acodada, pulgadas



315Z

	€		
1.1/16 in	69,63	1	315Z-1.1/16
1.1/8 in	69,63	1	315Z-1.1/8
1.3/16 in	72,54	1	315Z-1.3/16
1.1/4 in	75,44	1	315Z-1.1/4
1.5/16 in	78,34	1	315Z-1.5/16
1.3/8 in	98,63	1	315Z-1.3/8
1.7/16 in	92,59	1	315Z-1.7/16
1.1/2 in	94,21	1	315Z-1.1/2
1.5/8 in	110,26	1	315Z-1.5/8
1.11/16 in	113,17	1	315Z-1.11/16
1.3/4 in	121,86	1	315Z-1.3/4
1.13/16 in	124,75	1	315Z-1.13/16
1.7/8 in	133,46	1	315Z-1.7/8
1.15/16 in	136,34	1	315Z-1.15/16
2 mm	136,34	1	315Z-2
2.1/16 in	139,28	1	315Z-2.1/16
2.1/8 in	140,63	1	315Z-2.1/8
2.3/16 in	152,36	1	315Z-2.3/16
2.1/4 in	159,57	1	315Z-2.1/4
2.5/16 in	162,47	1	315Z-2.5/16
2.3/8 in	168,29	1	315Z-2.3/8
2.1/2 in	205,99	1	315Z-2.1/2
2.9/16 in	211,80	1	315Z-2.9/16
2.5/8 in	214,71	1	315Z-2.5/8

	€		
2.3/4 in	214,71	1	315Z-2.3/4
2.7/8 in	255,32	1	315Z-2.7/8
2.15/16 in	258,21	1	315Z-2.15/16
3 mm	264,01	1	315Z-3
3.1/8 in	269,82	1	315Z-3.1/8

Llave a tracción, extra-acodada, mm



310M

	€		
24 mm	56,13	1	310M-24
27 mm	56,13	1	310M-27
30 mm	56,13	1	310M-30
32 mm	59,59	1	310M-32
36 mm	68,16	1	310M-36
38 mm	82,01	1	310M-38
41 mm	83,76	1	310M-41
46 mm	93,39	1	310M-46
50 mm	112,45	1	310M-50
55 mm	125,86	1	310M-55
60 mm	154,83	1	310M-60
65 mm	175,07	1	310M-65
70 mm	190,84	1	310M-70
75 mm	208,17	1	310M-75
80 mm	228,69	1	310M-80
85 mm	246,05	1	310M-85
90 mm	488,93	1	310M-90
95 mm	529,93	1	310M-95

Mango tubular



R310

	€		
24-30 mm	19 mm	42,83	1 R310-0
32-41 mm	22 mm	48,30	1 R310-1
46-55 mm	25 mm	71,58	1 R310-2
60-95 mm	30 mm	91,48	1 R310-3

LLAVES DE TUBO

Llave de pipa abierta, mm



28M

	€		
6 mm	6 mm	14,75	5 28M-6
7 mm	7 mm	15,36	5 28M-7
8 mm	8 mm	12,64	5 28M-8
9 mm	9 mm	12,52	5 28M-9
10 mm	10 mm	13,21	5 28M-10
11 mm	11 mm	13,80	5 28M-11
12 mm	12 mm	14,63	5 28M-12
13 mm	13 mm	15,71	5 28M-13
14 mm	14 mm	18,00	5 28M-14
15 mm	15 mm	19,07	5 28M-15
16 mm	16 mm	20,11	5 28M-16
17 mm	17 mm	20,93	5 28M-17
18 mm	18 mm	25,25	3 28M-18
19 mm	19 mm	26,65	3 28M-19
20 mm	20 mm	28,56	3 28M-20
21 mm	21 mm	31,05	3 28M-21
22 mm	22 mm	36,06	3 28M-22
23 mm	23 mm	37,55	3 28M-23
24 mm	24 mm	39,80	3 28M-24
25 mm	25 mm	45,42	3 28M-25
26 mm	26 mm	49,33	3 28M-26
27 mm	27 mm	53,87	3 28M-27
28 mm	28 mm	62,03	1 28M-28
29 mm	29 mm	70,73	1 28M-29
30 mm	30 mm	80,27	1 28M-30
32 mm	32 mm	95,67	1 28M-32
6 mm	6 mm	11,65	10 SB28M-6
7 mm	7 mm	12,10	10 SB28M-7
8 mm	8 mm	12,65	10 SB28M-8
9 mm	9 mm	13,10	10 SB28M-9
10 mm	10 mm	13,79	10 SB28M-10
11 mm	11 mm	14,54	10 SB28M-11
12 mm	12 mm	15,39	10 SB28M-12
13 mm	13 mm	16,26	10 SB28M-13
14 mm	14 mm	19,05	10 SB28M-14
15 mm	15 mm	20,13	10 SB28M-15
16 mm	16 mm	21,20	5 SB28M-16
17 mm	17 mm	21,37	5 SB28M-17
18 mm	18 mm	26,43	5 SB28M-18
19 mm	19 mm	27,86	5 SB28M-19
20 mm	20 mm	29,79	4 SB28M-20
21 mm	21 mm	32,32	4 SB28M-21
22 mm	22 mm	37,45	4 SB28M-22
23 mm	23 mm	38,94	4 SB28M-23
24 mm	24 mm	41,23	4 SB28M-24

Llave de pipa abierta, mm



29M



mm	€	Icon 1	Icon 2
6 mm	14,75	5	29M-6
7 mm	15,36	5	29M-7
8 mm	13,22	5	29M-8
9 mm	13,13	5	29M-9
10 mm	13,21	5	29M-10
11 mm	13,71	5	29M-11
12 mm	14,85	5	29M-12
13 mm	15,40	5	29M-13
14 mm	18,00	5	29M-14
15 mm	19,07	5	29M-15
16 mm	20,11	5	29M-16
17 mm	20,29	5	29M-17
18 mm	25,25	3	29M-18
19 mm	26,65	3	29M-19
20 mm	28,56	3	29M-20
21 mm	31,05	3	29M-21
22 mm	36,06	3	29M-22
23 mm	37,55	3	29M-23
24 mm	39,80	3	29M-24
25 mm	45,42	3	29M-25
26 mm	49,33	3	29M-26
27 mm	53,87	3	29M-27
28 mm	62,03	1	29M-28
29 mm	70,73	1	29M-29
30 mm	80,27	1	29M-30
32 mm	95,67	1	29M-32

Juego de 8 llaves de pipa abierta, mm



28M/



mm	€	Icon 1	Icon 2
8	145,69	1	28M/8

28M-8, 28M-10, 28M-11, 28M-13, 28M-16, 28M-17, 28M-18, 28M-19



Juego de 11 llaves de pipa abiertas, mm



28M/11



mm	€	Icon 1	Icon 2
11	200,05	1	28M/11

28M-8, 28M-9, 28M-10, 28M-11, 28M-13, 28M-12, 28M-14, 28M-15, 28M-17, 28M-19, 28M-22



Juego de 12 llaves de pipa abiertas, mm



28M/12



mm	€	Icon 1	Icon 2
12	209,34	1	28M/12

28M-8, 28M-9, 28M-10, 28M-11, 28M-12, 28M-13, 28M-14, 28M-15, 28M-16, 28M-17, 28M-18, 28M-19



Juego de 8 llaves de pipa abiertas, mm



29M/



mm	€	Icon 1	Icon 2
8	158,79	1	29M/8

29M-8, 29M-10, 29M-12, 29M-13, 29M-14, 29M-17, 29M-19, 29M-22



Juego de 10 llaves de pipa abiertas, mm



29M/10



mm	€	Icon 1	Icon 2
10	178,12	1	29M/10

29M-8, 29M-10, 29M-11, 29M-12, 29M-13, 29M-14, 29M-16, 29M-17, 29M-18, 29M-19



Juego de 15 llaves de pipa abiertas, mm



28M/15



mm	€	Icon 1	Icon 2
15	316,26	1	28M/15

28M-8, 28M-9, 28M-10, 28M-11, 28M-12, 28M-13, 28M-14, 28M-15, 28M-16, 28M-17, 28M-18, 28M-19, 28M-21, 28M-22, 28M-24



Juego de 14 llaves de pipa abiertas, mm



29M/14



mm	€	Icon 1	Icon 2
14	309,50	1	29M/14

29M-11, 29M-12, 29M-13, 29M-14, 29M-8, 29M-9, 29M-10, 29M-16, 29M-17, 29M-21, 29M-22, 29M-19, 29M-24, 29M-23



Llave de tubo de dos bocas estampada hex, mm



1936M

Ø	€		
6x7 mm	6,01	50	1936M-6-7
8x9 mm	6,96	5	1936M-8-9
8x10 mm	8,16	30	1936M-8-10
10x11 mm	8,16	25	1936M-10-11
10x13 mm	8,91	25	1936M-10-13
12x13 mm	8,91	25	1936M-12-13
13x17 mm	10,37	20	1936M-13-17
14x15 mm	9,41	20	1936M-14-15
14x17 mm	10,21	15	1936M-14-17
16x17 mm	10,21	15	1936M-16-17
17x19 mm	12,18	10	1936M-17-19
18x19 mm	12,18	10	1936M-18-19
19x22 mm	13,42	8	1936M-19-22
20x22 mm	13,55	8	1936M-20-22
21x23 mm	15,52	8	1936M-21-23
22x24 mm	16,41	5	1936M-22-24
24x26 mm	17,26	5	1936M-24-26
24x27 mm	17,26	5	1936M-24-27
25x28 mm	19,02	5	1936M-25-28
30x32 mm	22,35	1	1936M-30-32
30x34 mm	34,37	4	1936M-30-34
36x41 mm	34,63	4	1936M-36-41
46x50 mm	68,96	2	1936M-46-50

Llave de tubo dos bocas, mm



27M

Ø	€		
6x7 mm	13,27	10	27M-6-7
8x9 mm	13,41	10	27M-8-9
10x11 mm	14,24	10	27M-10-11
12x13 mm	16,82	10	27M-12-13
13x17* mm	22,41	10	27M-13-17
14x15 mm	18,80	10	27M-14-15
16x17* mm	21,81	10	27M-16-17
16x18* mm	23,19	10	27M-16-18
18x19* mm	26,05	10	27M-18-19
20x22* mm	29,72	10	27M-20-22
21x23* mm	33,05	5	27M-21-23
21x24* mm	34,52	5	27M-21-24
24x26* mm	35,30	5	27M-24-26

Ø	€		
24x27* mm	35,92	5	27M-24-27
25x28* mm	40,60	5	27M-25-28
27x29* mm	46,37	5	27M-27-29
30x32* mm	51,96	5	27M-30-32
6x7 mm	14,42	10	SB27M-6-7
8x9 mm	14,56	10	SB27M-8-9
10x11 mm	15,39	10	SB27M-10-11
12x13 mm	18,00	10	SB27M-12-13
14x15 mm	19,95	10	SB27M-14-15
16x17* mm	22,99	10	SB27M-16-17
18x19* mm	27,22	10	SB27M-18-19
20x22* mm	30,84	10	SB27M-20-22
21x23* mm	34,18	5	SB27M-21-23
24x26* mm	37,94	5	SB27M-24-26

* Con agujero para mango escalonado (26S)

Juego de 7 llaves de tubo de dos bocas, mm



1936M/

Ø	€		
7	105,29	1	1936M/7

1936M-8-9, 1936M-10-11, 1936M-12-13, 1936M-14-15, 1936M-16-17, 1936M-18-19, 1936M-20-22
26S-610

Juego de 12 llaves de tubo de dos bocas, mm



1936M/12

Ø	€		
12	185,35	1	1936M/12

1936M-6-7, 1936M-8-9, 1936M-10-11, 1936M-12-13, 1936M-14-15, 1936M-16-17, 1936M-18-19, 1936M-20-22, 1936M-21-23, 1936M-24-27, 1936M-25-28, 1936M-30-32
26S-610, 26S-1216, 26S-16

Juego de 8 llaves de tubo dos bocas forjadas, mm



27M/T

Ø	€		
8	158,28	1	27M/8T

27M-6-7, 27M-8-9, 27M-10-11, 27M-12-13, 27M-14-15, 27M-16-17, 27M-18-19, 27M-20-22

Juego 12 llaves tubo en bolsa



27M/12T

Ø	€		
12	321,27	1	27M/12T

27M-6-7, 27M-8-9, 27M-10-11, 27M-12-13, 27M-14-15, 27M-16-17, 27M-18-19, 27M-20-22, 27M-21-23, 27M-24-26, 27M-25-28, 27M-30-32

Juego de 6 llaves de tubo dos bocas forjadas, mm



27M/

Ø	€		
6	98,35	1	27M/6

27M-6-7, 27M-8-9, 27M-10-11, 27M-12-13, 27M-14-15, 27M-16-17

Juego de 8 llaves de tubo de dos bocas forjadas, mm



27M/8

	€	
8	154,09	1 27M/8

27M-6-7, 27M-8-9, 27M-10-11, 27M-12-13, 27M-14-15, 27M-16-17, 27M-18-19, 27M-20-22



Juego de 10 llaves de tubo de dos bocas forjadas, mm



27M/10

	€	
10	222,42	1 27M/10

27M-6-7, 27M-8-9, 27M-10-11, 27M-12-13, 27M-14-15, 27M-16-17, 27M-18-19, 27M-20-22, 27M-21-23, 27M-24-26



Juego de 12 llaves de tubo de dos bocas forjadas, mm



27M/12

	€	
12	315,00	1 27M/12

27M-6-7, 27M-8-9, 27M-10-11, 27M-12-13, 27M-14-15, 27M-16-17, 27M-18-19, 27M-20-22, 27M-21-23, 27M-24-26, 27M-25-28, 27M-30-32



Mango escalonado para llave de tubo



26S

	€	
6 8 10 mm	11,34	10 26S-610
12 14 mm	26,48	8 26S-1216
16 mm	7,55	5 26S-16

Llave de vaso articulada de dos bocas, bihexagonal, mm



4040M

	€	
6x7 mm	38,95	1 4040M-6-7
8x9 mm	39,89	1 4040M-8-9
10x11 mm	40,76	1 4040M-10-11
10x13 mm	45,27	1 4040M-10-13
12x13 mm	42,45	1 4040M-12-13
13x17 mm	44,25	1 4040M-13-17
14x15 mm	44,50	1 4040M-14-15
16x17 mm	48,56	1 4040M-16-17
16x18 mm	50,02	1 4040M-16-18
18x19 mm	55,34	1 4040M-18-19
20x22 mm	65,74	1 4040M-20-22
21x23 mm	68,49	1 4040M-21-23

Llave de vaso articulada de dos bocas, bihexagonal, pulgadas



4040Z

	€	
3/8x7/16 in	39,35	1 4040Z-3/8-7/16
1/2x9/16 in	43,70	1 4040Z-1/2-9/16
5/8x11/16 in	46,58	1 4040Z-5/8-11/16
5/8x3/4 in	49,72	1 4040Z-5/8-3/4
13/16x7/8 in	57,12	1 4040Z-13/16-7/8

Juego de 6 llaves de vaso articuladas de dos bocas, bihexagonal, mm



4040M/S6

	€	
6	283,48	1 4040M/S6

4040M-8-9, 4040M-10-11, 4040M-12-13, 4040M-14-15, 4040M-16-17, 4040M-18-19



Juegos de 6 llaves de vaso articuladas de dos bocas, bihexagonal, mm



4040M/6T

	€	
6	267,07	1 4040M/6T

4040M-8-9, 4040M-10-11, 4040M-12-13, 4040M-14-15, 4040M-16-17, 4040M-18-19



LLAVES UNIVERSALES

Llave universal 5 en 1



MK5

	€	
97x25 mm	27,48	1 MK5

Perfil: Cuadrado hembra: 5,6,7-8mm Triángulo hembra: 9mm



Llave 9 en 1



MK9

	€		
--	---	--	--

95x95 mm 41,89 1 MK9

Perfil cuadrado: 5,6,7-8,9-10mm Triángulo: 7,8-9,10-11mm Dos posiciones 3-5 y cierre semiluna 6mm

LLAVES DE GANCHO ARTICULADAS

Llave de gancho articulada, mm



4106

	€		
--	---	--	--

19-50 mm	27,36	10	4106-19-50
32-75 mm	39,88	25	4106-32-75
50-120 mm	40,80	25	4106-50-120
115-165 mm	39,42	25	4106-115-165
150-230 mm	88,11	10	4106-150-230

Llave de gancho articulado tipo pin, mm



40B

	€		
--	---	--	--

19-50 mm	24,23	25	40B-19-50
32-75 mm	35,47	25	40B-32-75
50-120 mm	44,73	20	40B-50-120
115-165 mm	60,81	25	40B-115-165
150-230 mm	61,83	10	40B-150-230

Llave pivote, ajustable



4307/4310

	€		
--	---	--	--

10-50 mm	76,55	1	4307
22-100 mm	103,45	1	4310

Pasador de repuesto para llaves de gancho ajustables



40B-SP

	€		
--	---	--	--

40B-19-50	3,61	1	40B-19-50-SP
40B-32-75	3,61	1	40B-32-75-SP
40B-50-120	4,27	1	40B-50-120-SP
40B-115-165	4,27	1	40B-115-165-SP



Llaves de vaso y carracas



JUEGOS DE VASOS

Juego de vasos 1/4", 1/2" y llaves combinadas



S910



€



110 x 320 x 375 mm 218,36 2 S910

Juego de vasos 1/4", 1/2" llaves mixtas, 106 piezas



S106



€



110 x 430 x 375 mm 305,91 2 S106

Juego de vasos 1/4" y 1/2", 81 piezas



S81MIX



€



110 x 430 x 375 mm 221,45 2 S81MIX

Juego de vasos y llaves combinadas de 95 piezas 1/4" y 1/2"



S95



€



110 x 320 x 375 mm 235,09 2 S95

Juego de vasos 1/4" y llaves combinadas 1/4" y 1/2", 103 piezas



S103



€



110 x 375 x 430 mm 289,07 2 S103

Juego de vasos de 1/4" - 1/2", 41 piezas



S410



€



110 x 320 x 375 mm 126,69 2 S410

Juego de vasos 1/4" y 1/2" con llaves de vaso, 94 piezas



S87+7



€



110 x 430 x 375 mm 262,65 2 S87+7

Juego de vasos 1/2"+1/4", 108 piezas



S108



€



110 x 430 x 375 mm 306,94 2 S108

Juego de vasos 1/4" y 1/2", 77 piezas



S800



€



110 x 375 x 430 mm 290,56 2 S800

Juego de vasos y puntas 1/4" y 1/2", mm, 79 piezas



SW79

100 x 215 x 370 mm € 175,10 4 SW79

Juego vasos 1/4" y 1/2" y llaves combinadas, 138 piezas



S138

110 x 375 x 430 mm € 324,45 2 S138

Juego de 10 vasos serie larga 1/4", 10 piezas



S0810L

35 x 85 x 160 mm € 31,84 20 S0810L

Juego vasos de 1/2" y 1/4", 56 piezas



S560

100 x 215 x 375 mm € 118,45 4 S560

Juego de vasos 1/4", 3/8", 1/2", 137 piezas



S137

105 x 370 x 430 mm € 418,85 2 S137

Juego de vasos 1/4", 25 piezas



SL25

35 x 85 x 160 mm € 42,83 20 SL25

SB- Embalaje en blister

Juego de vasos y puntas 1/4" y 3/8", mm, 91 piezas



SW91

100 x 215 x 370 mm € 190,55 4 SW91

Juego de vasos de 1/4" y 1/2" y llaves, 92 piezas



S910AF

110 x 320 x 370 mm € 218,36 2 S910AF

SBS81

SBS61

Juego de vasos con cuadrado de 1/4", perfil hexagonal métrico y puntas de destornillador/portapuntas, 25 piezas/caja en blister



SBSL25

55 x 80 x 165 mm € 46,23 5 SBSL25



Juego de vasos 1/4", 24 piezas



SL24



€



35 x 85 x 160 mm

43,21

1

SL24

Juego de vasos 1/4"



S290



€



70 x 160 x 280 mm

71,58

6

S290

Juego vasos 1/4" y puntas, 65 piezas



SW65



€



70 x 160 x 280 mm

92,70

6

SW65

Juego de vasos de 1/4", 37 piezas



SL25L



€



46 x 130 x 195 mm

60,17

10

SL25L

Juego de vasos 1/4", 46 piezas



S460



€



100 x 215 x 375 mm

110,91

6

S460

Juego vasos 1/4", 25 piezas, en pulgadas



SL25AF



€



35 x 85 x 165 mm

42,83

20

SL25AF

Juego de vasos 1/4", 16 piezas



S160



€



70 x 160 x 280 mm

49,44

6

S160

Juego de vasos y puntas 1/4", 65 piezas



SL65



€



70 x 160 x 280 mm

86,52

6

SL65

Juego de vasos 1/4"



S160AF



€



70 x 160 x 280 mm

49,44

6

S160AF

Juego de vasos 1/4", 12 piezas



6712R

	€		
31 x 110 x 178 mm	125,40	1	6712R

6700SM-4, 6700SM-5, 6700SM-5.5, 6700SM-6, 6700SM-7, 6700SM-8, 6700SM-10, 6700SM-11, 6700SM-13		
6950		
6960, 6962		

Juego de vasos 1/4", 12 piezas



6712RN

	€		
31 x 108 x 178 mm	120,37	1	6712RN

6700SM-4, 6700SM-5, 6700SM-5.5, 6700SM-6, 6700SM-7, 6700SM-8, 6700SM-10, 6700SM-11, 6700SM-13		
6960, 6962		
6950RN		

Juego de vasos 1/4", 15 piezas



A6716DM

	€		
35 x 111 x 223 mm	153,56	1	A6716DM

A6700DM-5.5, A6700DM-6, A6700DM-7, A6700DM-8, A6700DM-9, A6700DM-10, A6700DM-11, A6700DM-12, A6700DM-13, A6700DM-14		
6956		
6962		
6966		
6954		
6950		

Juego de vasos 1/4", 16 piezas



6715MGS

	€		
34 x 113 x 223 mm	166,88	1	6715MGS

SB6700SM-4, 6700SM-4.5, 6700SM-5, 6700SM-5.5, 6700SM-6, 6700SM-7, 6700SM-8, 6700SM-9, 6700SM-10, 6700SM-11, 6700SM-13		
6954		
6950RN		
6956		
6966		
6962		

Juego de vasos 1/4", 32 piezas



6719MHR

	€		
50 x 110 x 220 mm	179,64	1	6719MHR

6700SM-4, 6700SM-4.5, 6700SM-5.5, 6700SM-5, 6700SM-6, 6700SM-7, 6700SM-8, 6700SM-9, 6700SM-10, 6700SM-11, 6700SM-12, 6700SM-13, 6700SM-14		
6950RN		
6960, 6962		
6954		
6956		
6966		

Juego de vasos 1/4", 15 piezas



6729MHR

	€		
50 x 110 x 220 mm	189,76	1	6729MHR

6700SM-4, 6700SM-5, 6700SM-6, 6700SM-7, 6700SM-8, 6700SM-9, 6700SM-10, 6700SM-11, 6700SM-13, 6700SM-14		
6950RN		
6960, 6962		
6966		
6956		
6973A		
59S/PH1, 59S/PH2, 59S/PH3		
59S/PZ1, 59S/PZ2, 59S/PZ3		
59S/0.6-4.5, 59S/0.8-5.5, 59S/1.2-6.5		
59S/H3, 59S/H4, 59S/H5, 59S/H6		



Juego de vasos 1/4", 16 piezas



6729MHP

50 x 110 x 220 mm € 193,09 1 6729MHP

6700SM-4, 6700SM-5, 6700SM-6, 6700SM-7, 6700SM-8, 6700SM-9, 6700SM-10, 6700SM-11, 6700SM-13, 6700SM-14

6950

6960, 6962

6966

6956

6973A

59S/0.6-4.5, 59S/0.8-5.5, 59S/1.2-6.5

59S/PZ1, 59S/PZ2, 59S/PZ3

59S/PH1, 59S/PH2, 59S/PH3

59S/H3, 59S/H4, 59S/H5, 59S/H6



Juego de vasos 1/4", 17 piezas



6717MBP

50 x 110 x 220 mm € 173,99 1 6717MBP

A6700DM-5, A6700DM-5.5, A6700DM-6, A6700DM-7, A6700DM-8, A6700DM-9, A6700DM-10, A6700DM-11, A6700DM-12, A6700DM-13, A6700DM-14

6950

6960, 6962

6954

6966

6956

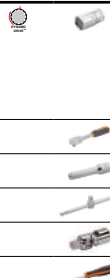

Juego de vasos 1/4", 27 piezas



6730MBP

50 x 110 x 220 mm € 197,59 1 6730MBP

A6700DM-5, A6700DM-5.5, A6700DM-6, A6700DM-7, A6700DM-8, A6700DM-9, A6700DM-10, A6700DM-11, A6700DM-12, A6700DM-13, A6700DM-14

6950

6960, 6962

6954

6966

6956

6973A

59S/0.6-4.5, 59S/1.2-6.5, 59S/0.8-5.5

59S/PH1, 59S/PH2, 59S/PH3

59S/PZ1, 59S/PZ2, 59S/PZ3

59S/H3, 59S/H4, 59S/H5, 59S/H6



Juego de vasos 1/4", 17 piezas



6719SM

41 x 113 x 223 mm € 170,20 1 6719SM

6700SM-4, 6700SM-4.5, 6700SM-5, 6700SM-5.5, 6700SM-6, 6700SM-7, 6700SM-8, 6700SM-9, 6700SM-10, 6700SM-11, 6700SM-12, 6700SM-13

6954

6950

6956

6966

6962



Juego de vasos 1/4", 20 piezas



6715MG

35 x 111 x 223 mm € 205,49 1 6715MG

6700SM-4, 6700SM-4.5, 6700SM-5, 6700SM-5.5, 6700SM-6, 6700SM-7, 6700SM-8, 6700SM-9, 6700SM-10, 6700SM-11, 6700SM-12, 6700SM-13, 6700SM-14

6954

6958

6956

6962, 6960

6966

6950RN



Juego de vasos 1/4", 21 piezas



6721NM

41 x 113 x 223 mm € 278,06 1 6721NM

6700SM-4, 6700SM-4.5, 6700SM-5, 6700SM-5.5, 6700SM-6, 6700SM-7, 6700SM-8, 6700SM-9, 6700SM-10, 6700SM-11, 6700SM-12, 6700SM-13, 6700SM-14

6954

6951

6956

6950

6962, 6960

6966

6958

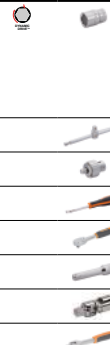

Juego de vasos 1/4", 27 piezas



6722M

41 x 113 x 223 mm € 226,83 1 6722M

6700SM-4, 6700SM-5, 6700SM-6, 6700SM-7, 6700SM-8, 6700SM-9, 6700SM-10, 6700SM-11, 6700SM-13, 6700SM-14

6954

6956

6950

6966

6960, 6962

6972H

59S/H3, 59S/H4, 59S/H5, 59S/H6

59S/PH1, 59S/PH2, 59S/PH3

Juego de vasos 1/4", 29 piezas



6715PZ

41 x 113 x 223 mm € 255,22 1 6715PZ

6700SM-4, 6700SM-4.5, 6700SM-5, 6700SM-5.5, 6700SM-6, 6700SM-7, 6700SM-8, 6700SM-9, 6700SM-10, 6700SM-11, 6700SM-12, 6700SM-13

6956

6950

6954

6962, 6960

6966

6709F-4.5, 6709F-5.5, 6709F-8

6709M-3, 6709M-4, 6709M-5, 6709M-6, 6709M-8

6709PZ-1, 6709PZ-3, 6709PZ-2

Juego de vasos 1/4", 33 piezas



6720NM

43 x 114 x 351 mm € 311,37 1 6720NM

6700SM-4, 6700SM-4.5, 6700SM-5, 6700SM-5.5, 6700SM-6, 6700SM-7, 6700SM-8, 6700SM-9, 6700SM-10, 6700SM-11, 6700SM-12, 6700SM-13, 6700SM-14

1931M-4, 1931M-4.5, 1931M-9, 1931M-10, 1931M-11, 1931M-14, 1931M-13, 1931M-12, 1931M-7, 1931M-8, 1931M-6, 1931M-5.5, 1931M-5

6954

6950

6956

221 D

73721-3-80

6966

6962

Juego de vasos 1/4", 27 piezas



6715GE

31 x 113 x 223 mm € 223,49 1 6715GE

6700SM-4, 6700SM-5, 6700SM-6, 6700SM-7, 6700SM-8, 6700SM-9, 6700SM-10, 6700SM-11, 6700SM-13, 6700SM-14

6956

6950RN

6954

6966

6960, 6962

6972H

59S/H3, 59S/H4, 59S/H5, 59S/H6

59S/PH1, 59S/PH2, 59S/PH3

Juego de vasos, 29 piezas



6715GJ

50 x 113 x 223 mm € 256,16 1 6715GJ

6700SM-4, 6700SM-4.5, 6700SM-5, 6700SM-5.5, 6700SM-6, 6700SM-7, 6700SM-8, 6700SM-9, 6700SM-10, 6700SM-11, 6700SM-12, 6700SM-13

6956

6962, 6960

6709F-4.5, 6709F-5.5, 6709F-8

6709M-5, 6709M-6, 6709M-8, 6709M-4, 6709M-3

6954

6950

6966

6709PH-1, 6709PH-2, 6709PH-3

Juego de llaves de vaso 1/4", 15 piezas, pulgadas



A6716DZ

41 x 113 x 223 mm € 165,38 1 A6716DZ

A6700DZ-3/16, A6700DZ-7/32, A6700DZ-1/4, A6700DZ-9/32, A6700DZ-5/16, A6700DZ-11/32, A6700DZ-3/8, A6700DZ-7/16, A6700DZ-1/2, A6700DZ-9/16

6956

6962

6966

6954

6950



Juego de vasos 1/4", 18 piezas, pulgadas



A6718DZ

41 x 113 x 223 mm 1185 g 181,95 1 A6718DZ

6950	
6951	
6956	
6954	
6958	
6960, 6962	
6966	
A6700DZ-3/16, A6700DZ-7/32, A6700DZ-1/4, A6700DZ-9/32, A6700DZ-5/16, A6700DZ-11/32, A6700DZ-3/8, A6700DZ-7/16, A6700DZ-1/2, A6700DZ-9/16	

Juego de vasos 1/4", 19 piezas



6821NZ

50 x 113 x 223 mm 269,96 1 6821NZ

6700SZ-1/4, 6700SZ-11/32, 6700SZ-1/2, 6700SZ-3/16, 6700SZ-5/32, 6700SZ-7/32, 6700SZ-9/32, 6700SZ-5/16, 6700SZ-3/8, 6700SZ-7/16, 6700SZ-9/16	
6954	
6958	
6950	
6956	
6960, 6962	
6966	
6951	

Juego de vasos 1/4", 25 piezas, mm y pulgadas



6715MZ

40 x 126 x 230 mm 206,86 1 6715MZ

6700SM-4, 6700SM-4.5, 6700SM-5, 6700SM-5.5, 6700SM-6, 6700SM-8, 6700SM-9, 6700SM-10, 6700SM-11, 6700SM-13	
6700SZ-7/32, 6700SZ-3/16, 6700SZ-1/4, 6700SZ-9/32, 6700SZ-5/16, 6700SZ-11/32, 6700SZ-3/8, 6700SZ-7/16, 6700SZ-1/2	
6954	
6950	
6956	
6966	
6962	

Juego de 9 vasos largos de 1/4" para tornillos de cabeza hexagonal métricos e imperiales



A6709MZ/9

46 x 130 x 195 mm 201,37 1 A6709MZ/9

A6709M-2.5, A6709M-3, A6709M-4, A6709M-5, A6709M-6	
A6709Z-1/8, A6709Z-9/64, A6709Z-5/32, A6709Z-3/16	
SPAR-CASE-A6	

Juego de vasos 1/4" en rail, 13 piezas, en mm



6729SM

25 x 55 x 190 mm 79,67 1 6729SM

6700SM-4, 6700SM-4.5, 6700SM-5, 6700SM-5.5, 6700SM-6, 6700SM-7, 6700SM-8, 6700SM-9, 6700SM-10, 6700SM-11, 6700SM-12, 6700SM-13, 6700SM-14	
6956	

Juego de vasos 7 piezas



6729SZ

25 x 55 x 190 mm 53,26 1 6729SZ

6700SZ-1/4, 6700SZ-11/32, 6700SZ-1/2, 6700SZ-3/16, 6700SZ-7/32, 6700SZ-3/8, 6700SZ-7/16	
6956	

Juego de 13 llaves de vaso 1/4", en rail, mm



6713MH

13 68,64 1 6713MH

6700SM-4, 6700SM-4.5, 6700SM-5, 6700SM-5.5, 6700SM-6, 6700SM-7, 6700SM-8, 6700SM-9, 6700SM-10, 6700SM-11, 6700SM-12, 6700SM-13, 6700SM-14	
---	--

Juego de 8 vasos 1/4" en rail, mm



6708DMB

	€		
8	94,59	1	6708DMB

A6800DM-6, A6800DM-7, A6800DM-8, A6800DM-9, A6800DM-10, A6800DM-11, A6800DM-12, A6800DM-13



Juego de 11 vasos 1/4", en rail



6711MB

	€		
11	59,75	1	6711MB

A6700DM-5, A6700DM-5.5, A6700DM-6, A6700DM-7, A6700DM-8, A6700DM-9, A6700DM-10, A6700DM-11, A6700DM-12, A6700DM-13, A6700DM-14



Juego de 6 llaves vaso 1/4" en rail



6706TE

	€		
6	47,00	1	6706TE

6700TORX-E4, 6700TORX-E5, 6700TORX-E6, 6700TORX-E7, 6700TORX-E8, 6700TORX-E10



Juego de herramientas en caja de metal, mm



R6725MK

	€		
26 x 105 x 175 mm	259,10	1	R6725MK

6700SM-7, 6700SM-8, 6700SM-10



6954

R6967

R6810M-3,4, R6810M-4, R6810M-4,5, R6810M-5, R6810M-6, R6810M-7, R6810M-8, R6810M-9, R6810M-10

6966

R6950



6962

R6964A

Juego de herramientas en caja de metal, pulgadas



R6725ZK

	€		
48 x 115 x 225 mm	248,84	1	R6725ZK

6700SZ-1/4, 6700SZ-5/16, 6700SZ-11/32, 6700SZ-3/8, 6700SZ-7/16, 6700SZ-1/2



6954

R6967

R6950



6962

R6810M-6

R6964A

6966

R6810Z-3/16, R6810Z-7/32, R6810Z-1/4, R6810Z-5/16, R6810Z-3/8

R6822Z

Juego de 14 vasos 3/8" serie larga



S1214L

	€		
49 x 152 x 280 mm	58,25	10	S1214L

Juego de llaves de vaso 1/4" y 3/8", 33 piezas



S330

	€		
70 x 160 x 280 mm	78,26	6	S330

Juego de vasos 1/4" y 3/8", 53 piezas



S330L

	€		
100 x 215 x 375 mm	114,01	4	S330L



Juego vasos 3/8", 38 piezas



S380



100 x 215 x 375 mm 113,16 4 S380

Juego de vasos 3/8" con cabeza delgada, 34 piezas



SL34



70 x 160 x 280 mm 83,32 6 SL34

Juego de vasos con accionamiento exterior y carraca pasante, 14 piezas



S140T

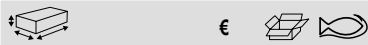

65 x 160 x 280 mm 70,90 1 S140T

SBS19-THR

SBS19-TH75

SBS19-TH10, SBS19-TH11, SBS19-TH12, SBS19-TH13, SBS19-TH14, SBS19-TH15, SBS19-TH16, SBS19-TH17, SBS19-TH18, SBS19-TH19, SBS19-TH21, SBS19-TH22, SBS19-TH24

SBS19-TH20

Juego de llave de carraca con cuadrado pasante, 3 piezas



S140T-R



121 x 280 x 220 mm 43,26 10 S140T-R

Carraca 72 dientes, Adaptador 19mm-3/4" para cuadrado 3/8", Adaptador 19mm-3/4" para cuadrado 1/2"

SBS19-THR

1RMA-19-3/8-SQ

1RMA-19-1/2-SQ

Juego de vasos pasantes, 53 piezas



S530T

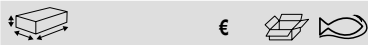

90 x 205 x 370 mm 196,41 4 S530T

Juego de vasos de 3/8 y 1/4"



S330AF



70 x 160 x 280 mm 78,26 6 S330AF

Juego de vasos 3/8" 22 piezas, Bihex.,mm



A7435DME

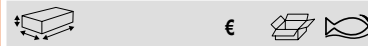

40 x 150 x 500 mm 330,41 1 A7435DME

A7400DM-9, A7400DM-10, A7400DM-11, A7400DM-12, A7400DM-13, A7400DM-14, A7400DM-15, A7400DM-16, A7400DM-17, A7400DM-18, A7400DM-19, A7400DM-20, A7400DM-21, A7400DM-22

7755-3/8

7754

7760, 7762, 7761

7758

7752

7766

Juego de vasos de 3/8", 17 piezas, Bihex., mm



A7440DME

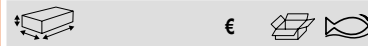

50 x 115 x 312 mm 212,59 1 A7440DME

7755-3/8

7758

7761

A7400DM-9, A7400DM-12, A7400DM-13, A7400DM-14, A7400DM-15, A7400DM-16, A7400DM-17, A7400DM-10, A7400DM-11, A7400DM-22, A7400DM-20, A7400DM-21, A7400DM-18, A7400DM-19

Juego de vasos 3/8", 22 piezas



7422MBR

60 x 220 x 280 mm € 248,73 1 7422MBR

A7400DM-6, A7400DM-7, A7400DM-8, A7400DM-9, A7400DM-10, A7400DM-11, A7400DM-12, A7400DM-13, A7400DM-14, A7400DM-15, A7400DM-16, A7400DM-17, A7400DM-18, A7400DM-19, A7400DM-20, A7400DM-21, A7400DM-22

- 7750RN
- 7760, 7762
- 7754
- 7766

Juego de vasos 3/8", 22 piezas



7422MHR

50 x 160 x 350 mm € 241,85 1 7422MHR

7400SM-6, 7400SM-7, 7400SM-8, 7400SM-9, 7400SM-10, 7400SM-11, 7400SM-12, 7400SM-13, 7400SM-14, 7400SM-15, 7400SM-16, 7400SM-17, 7400SM-18, 7400SM-19, 7400SM-20, 7400SM-21, 7400SM-22

- 7750RN
- 7760, 7762
- 7754
- 7766

Juego de vasos 3/8", 20 piezas, Bihex., pulgadas



A7535DZE

165 x 500 x 45 mm € 397,56 1 A7535DZE

A7400DZ-1/2, A7400DZ-17/32, A7400DZ-1/4, A7400DZ-3/4, A7400DZ-13/16, A7400DZ-19/32, A7400DZ-11/16, A7400DZ-3/8, A7400DZ-7/16, A7400DZ-5/16, A7400DZ-7/8, A7400DZ-9/16, A7400DZ-5/8

- 7755-3/8
- 7754
- 7760, 7762
- 7766
- 7758
- 7752

Juego de vasos 3/8" 12 piezas, en rail



7400SR/

12 35 x 220 x 25 mm € 82,22 1 7400SR/S12

7400SM-11, 7400SM-10, 7400SM-15, 7400SM-14, 7400SM-13, 7400SM-12, 7400SM-16, 7400SM-9, 7400SM-8, 7400SM-17, 7400SM-19, 7400SM-18

Juego de 9 vasos 3/8" en rail, mm



7409MB

9 € 69,49 1 7409MB

A7400DM-7, A7400DM-8, A7400DM-10, A7400DM-11, A7400DM-13, A7400DM-15, A7400DM-17, A7400DM-19, A7400DM-22

Juego de 8 vasos 3/8" en rail, mm



7408MD

8 € 118,13 1 7408MD

A7402DM-10, A7402DM-11, A7402DM-12, A7402DM-13, A7402DM-14, A7402DM-16, A7402DM-17, A7402DM-19

Juego de 7 vasos 3/8"



7400TORX-ER/

7 25 x 55 x 190 mm € 80,21 1 7400TORX-ER/S7

7400TORX-E14, 7400TORX-E12, 7400TORX-E11, 7400TORX-E10, 7400TORX-E18, 7400TORX-E16, 7400TORX-E8



Juego de 12 vasos 1/2" serie larga



S1612L

49 x 152 x 280 mm € 71,63 4 S1612L

Juego de vasos 1/2" con puntas hexagonales, 18 piezas



S18HEX

100 x 210 x 370 mm € 98,67 4 S18HEX

Juego de vasos 1/2" con puntas hexagonales, 9 piezas



S9HEX

46 x 130 x 195 mm € 49,44 10 S9HEX

Juego de 18 vasos de 1/2" con puntas TORX



S18TORX

100 x 210 x 370 mm € 101,00 4 S18TORX

Juego de 9 vasos de 1/2" con puntas TORX



S9TORX

46 x 130 x 195 mm € 49,44 10 S9TORX

Juego de vasos 1/2", 24 piezas



S240

100 x 215 x 375 mm € 123,95 4 S240

- SBS81
- 8166
- 8160-5, 8160-10
- 7772H
- 8158-10

7800SM-10, 7800SM-11, 7800SM-12, 7800SM-13, 7800SM-14, 7800SM-15, 7800SM-16, 7800SM-17, 7800SM-18, 7800SM-19, 7800SM-20, 7800SM-21, 7800SM-22, 7800SM-23, 7800SM-24, 7800SM-27, 7800SM-30, 7800SM-32



S240-BOX

Juego de vasos 1/2" y llaves mixtas, 40 piezas



S400

110 x 320 x 375 mm € 183,64 2 S400

7800SM-10, 7800SM-11, 7800SM-12, 7800SM-13, 7800SM-14, 7800SM-15, 7800SM-16, 7800SM-17, 7800SM-18, 7800SM-19, 7800SM-20, 7800SM-21, 7800SM-22, 7800SM-23, 7800SM-24, 7800SM-25, 7800SM-26, 7800SM-27, 7800SM-28, 7800SM-30, 7800SM-32



SBS81

- 8160-5, 8160-10
- 8166
- 7772H
- 8158-10
- 111M-7, 111M-8, 111M-9, 111M-10, 111M-11, 111M-12, 111M-13, 111M-14, 111M-15, 111M-16, 111M-17, 111M-18, 111M-19

Juego de vasos 1/2"



S240AF

100 x 215 x 375 mm € 123,95 4 S240AF

Juego de vasos de 1/2" y llaves combinadas



S350AF

110 x 371 x 313 mm 192,56 2 S350AF

S 3/8, S 9/16, S 1.1/4, S 1.1/16, S 1.3/16, S 15/16, S 1.1/8, S 1/2, S 1", S 5/8, S 7/8, S 3/4, S 7/16

- 815
- 703/A MP
- 763, 753
- 773

Juego de 10 vasos con punta 1/2", mm



7809M/10

45 x 110 x 255 mm 147,00 1 7809M/10

7809M-5, 7809M-6, 7809M-7, 7809M-8, 7809M-9, 7809M-10, 7809M-12, 7809M-14, 7809M-17, 7809M-19

Juego de 10 vasos con punta 1/2", pulgadas



7809Z/10

45 x 110 x 255 mm 142,09 1 7809Z/10

7809Z-3/8, 7809Z-5/16, 7809Z-7/16, 7809Z-1/4, 7809Z-19/32, 7809Z-5/8, 7809Z-17/32, 7809Z-9/16, 7809Z-1/2, 7809Z-3/16

Juego de 10 vasos con puntas TORX® y HEXAGONALES 1/2"



7809TORX/10

45 x 110 x 255 mm 160,82 1 7809TORX/10

7809TORX-T20, 7809TORX-T27, 7809TORX-T25, 7809TORX-T40, 7809TORX-T30, 7809TORX-T45, 7809TORX-T50, 7809TORX-T55

7809M-6, 7809M-8

Juego de vasos 1/2", 14 piezas



7814DS

60 x 185 x 445 mm 225,13 1 7814DS

7800DM-10, 7800DM-11, 7800DM-12, 7800DM-13, 7800DM-14, 7800DM-15, 7800DM-16, 7800DM-17, 7800DM-18, 7800DM-19

8150SL
8160-5, 8160-10
8166

Juego de vasos 1/2", 18 piezas



7818DS

60 x 185 x 445 mm 273,56 1 7818DS

7800DM-8, 7800DM-10, 7800DM-11, 7800DM-12, 7800DM-13, 7800DM-14, 7800DM-15, 7800DM-16, 7800DM-17, 7800DM-18, 7800DM-19, 7800DM-21, 7800DM-22

8150SL
8160-5, 8160-10
8154-11
8166

Juego de vasos 1/2", 17 piezas



7818MHR

50 x 185 x 445 mm 274,78 1 7818MHR

7800SM-10, 7800SM-11, 7800SM-12, 7800SM-13, 7800SM-14, 7800SM-15, 7800SM-17, 7800SM-19, 7800SM-22, 7800SM-24, 7800SM-27, 7800SM-30, 7800SM-32

8150RN-1/2
8160-5, 8160-10
8154-11
8166



Juego de vasos 1/2", 25 piezas



7825MHP

60 x 185 x 445 mm € 328,80 1 7825MHP

7800SM-10, 7800SM-11, 7800SM-12, 7800SM-13, 7800SM-14, 7800SM-15, 7800SM-16, 7800SM-17, 7800SM-18, 7800SM-19, 7800SM-20, 7800SM-21, 7800SM-22, 7800SM-23, 7800SM-24, 7800SM-26, 7800SM-27, 7800SM-28, 7800SM-30, 7800SM-32

8150-1/2

8160-5, 8160-10

8154-11

8166

Juego de vasos 1/2", 25 piezas



7819DRN

51 x 225 x 445 mm € 359,36 1 7819DRN

7800DM-19, 7800DM-18, 7800DM-17, 7800DM-16, 7800DM-23, 7800DM-22, 7800DM-21, 7800DM-11, 7800DM-10, 7800DM-15, 7800DM-13, 7800DM-14, 7800DM-12, 7800DM-24, 7800DM-26, 7800DM-27, 7800DM-28, 7800DM-30, 7800DM-32

8150RN-1/2

8152-1/2

8166-1/2

8160-5, 8160-10

8154-11

8166

Juego de vasos 1/4" y 1/2", 47 piezas



7847SS

60 x 225 x 445 mm € 565,69 1 7847SS

6700SM-5, 6700SM-6, 6700SM-7, 6700SM-8, 6700SM-9, 6700SM-10, 6700SM-11, 6700SM-12, 6700SM-13

6950SL

6960, 6962

6954

6966

6956

59S/PH1, 59S/PH2, 59S/PH3

59S/PZ1, 59S/PZ2, 59S/PZ3

59S/0.6-4.5, 59S/0.8-5.5, 59S/1.2-8.0

59S/H3, 59S/H4, 59S/H5, 59S/H6

7800SM-10, 7800SM-11, 7800SM-12, 7800SM-13, 7800SM-14, 7800SM-15, 7800SM-17, 7800SM-19, 7800SM-22, 7800SM-24, 7800SM-27, 7800SM-30, 7800SM-32

8150SL

6973A

8160-5, 8160-10

8154-11

8166

Juego de vasos 1/2", 26 piezas



7825MBP

60 x 185 x 445 mm € 328,87 1 7825MBP

7800DM-10, 7800DM-11, 7800DM-12, 7800DM-13, 7800DM-14, 7800DM-15, 7800DM-16, 7800DM-17, 7800DM-18, 7800DM-19, 7800DM-20, 7800DM-21, 7800DM-22, 7800DM-23, 7800DM-24, 7800DM-26, 7800DM-27, 7800DM-28, 7800DM-30, 7800DM-32

8150-1/2

8160-5, 8160-10

8154-11

8166

Juego de vasos 1/2", 25 piezas



7888DM

73 x 340 x 445 mm € 368,78 1 7888DM

7800DM-10, 7800DM-11, 7800DM-12, 7800DM-13, 7800DM-14, 7800DM-15, 7800DM-16, 7800DM-17, 7800DM-18, 7800DM-19, 7800DM-20, 7800DM-21, 7800DM-22, 7800DM-23, 7800DM-24, 7800DM-26, 7800DM-27, 7800DM-28, 7800DM-30, 7800DM-32

8150-1/2

8154-11

8160-3, 8160-5, 8160-10

8166

8157-15

Juego de vasos 1/2", pulgadas, 17 piezas



7817DZS

60 x 185 x 445 mm € 264,01 1 7817DZS

7800DZ-3/8, 7800DZ-7/16, 7800DZ-1/2,
7800DZ-9/16, 7800DZ-5/8, 7800DZ-
11/16, 7800DZ-3/4, 7800DZ-13/16,
7800DZ-7/8, 7800DZ-15/16, 7800DZ-1,
7800DZ-1.1/8, 7800DZ-1.1/4

8150SL

8160-5, 8160-10

8166

Juego de vasos y puntas 1/2", 16 piezas



7817DZS1

60 x 185 x 445 mm 4500 g 212,56 1 7817DZS1

7800DZ-3/8, 7800DZ-7/16, 7800DZ-1/2,
7800DZ-9/16, 7800DZ-5/8, 7800DZ-
11/16, 7800DZ-3/4, 7800DZ-13/16,
7800DZ-7/8, 7800DZ-15/16, 7800DZ-1,
7800DZ-1.1/8, 7800DZ-1.1/4

8150SL

8160-5, 8160-10

8166

Juego de vasos 1/2", AF, 23 piezas



7823DZS

60 x 185 x 445 mm 310,93 1 7823DZS

7800DZ-3/8, 7800DZ-7/16, 7800DZ-1/2,
7800DZ-9/16, 7800DZ-19/32, 7800DZ-
5/8, 7800DZ-11/16, 7800DZ-3/4,
7800DZ-25/32, 7800DZ-13/16, 7800DZ-
7/8, 7800DZ-15/16, 7800DZ-1, 7800DZ-
1.1/16, 7800DZ-1.1/8, 7800DZ-1.3/16,
7800DZ-1.1/4, 7800DZ-1.5/16

8150SL

8160-5, 8160-10

8154-11

8166

Juego de vasos 1/2", 18 piezas



7818DST

60 x 220 x 480 mm 243,83 1 7818DST

7800DM-8, 7800DM-10, 7800DM-11,
7800DM-12, 7800DM-13, 7800DM-14,
7800DM-15, 7800DM-16, 7800DM-17,
7800DM-18, 7800DM-19, 7800DM-21,
7800DM-22

8150SL

8160-5, 8160-10

8166

8154-11

Juego de vasos 1/2", 18 piezas



7818SST

60 x 220 x 480 mm 254,94 1 7818SST

7800SM-10, 7800SM-11, 7800SM-12,
7800SM-13, 7800SM-14, 7800SM-15,
7800SM-17, 7800SM-19, 7800SM-22,
7800SM-24, 7800SM-27, 7800SM-30,
7800SM-32

8150SL

8160-1/2, 8162-1/2, 8166-1/2, 8154-1/2

Juego de vasos 1/2", 25 piezas



7825SST

65 x 250 x 480 mm 307,42 1 7825SST

7800SM-10, 7800SM-11, 7800SM-12, 7800SM-
13, 7800SM-14, 7800SM-15, 7800SM-16,
7800SM-17, 7800SM-18, 7800SM-19, 7800SM-
20, 7800SM-21, 7800SM-22, 7800SM-23,
7800SM-24, 7800SM-26, 7800SM-27, 7800SM-
28, 7800SM-30, 7800SM-32

8150SL

8160-1/2, 8162-1/2, 8166-1/2, 8154-1/2

Juego de vasos 1/2", 25 piezas



7825DST

65 x 250 x 480 mm 307,42 1 7825DST

7800DM-10, 7800DM-11, 7800DM-12,
7800DM-13, 7800DM-14, 7800DM-15,
7800DM-16, 7800DM-17, 7800DM-18,
7800DM-19, 7800DM-20, 7800DM-21,
7800DM-22, 7800DM-23, 7800DM-24,
7800DM-26, 7800DM-27, 7800DM-28

8150SL

8160-1/2, 8162-1/2, 8166-1/2, 8154-1/2



Juego de vasos 1/2", 27 piezas



7827DST

65 x 250 x 480 mm € 370,65 1 7827DST

7800DM-10, 7800DM-11, 7800DM-12, 7800DM-13, 7800DM-14, 7800DM-15, 7800DM-16, 7800DM-17, 7800DM-18, 7800DM-19, 7800DM-20, 7800DM-21, 7800DM-22, 7800DM-23, 7800DM-24, 7800DM-26, 7800DM-27, 7800DM-28, 7800DM-30, 7800DM-32

8150SL
8159-1/2, 8160-1/2, 8162-1/2, 8154-1/2, 8166-1/2, 8158-1/2

Juego de 10 vasos 1/2" en rail, mm



7810MH

10 € 75,77 1 7810MH

7800SM-10, 7800SM-11, 7800SM-13, 7800SM-14, 7800SM-15, 7800SM-16, 7800SM-19, 7800SM-17, 7800SM-21, 7800SM-22

Juego de 10 vasos 1/2"



7810MB

10 € 75,77 1 7810MB

7800DM-11, 7800DM-10, 7800DM-14, 7800DM-13, 7800DM-16, 7800DM-17, 7800DM-19, 7800DM-22, 7800DM-21, 7800DM-15

Juego de 6 vasos 1/2" en rail, mm



7806MD

6 € 103,61 1 7806MD

7805DM-10, 7805DM-14, 7805DM-13, 7805DM-17, 7805DM-19, 7805DM-22

Juego de 6 vasos 1/2" en rail



7807TE

7 € 72,98 1 7807TE

7800TORX-E10, 7800TORX-E12, 7800TORX-E14, 7800TORX-E16, 7800TORX-E18, 7800TORX-E20, 7800TORX-E24

Juego de vasos de 3/4", 17 piezas



SLX 17

375 x 430 x 110 mm € 269,86 1 SLX 17

12 vasos hex 22-50, Cabeza carraca 24d-S91, Mango ext S93, Cuadrado mango corr, Alarg 200, Alarg 400

Juego de vasos hex 3/4", 17 piezas, en pulgadas



SLX17AF

70 x 375 x 430 mm € 269,86 1 SLX 17AF

12 vasos hex, Cabeza carraca 24d-S91, Mango ext S93, Cuadrado mango corr, Alarg 8", Alarg 16"

Juego de vasos hex 3/4", 15 piezas, mm



8845NM

	€		
94 x 206 x 591 mm	583,74	1	8845NM

Este producto no está garantizado contra la rotura del cuadrado macho.

8900SM-24, 8900SM-22, 8900SM-27, 8900SM-30, 8900SM-32, 8900SM-36, 8900SM-38, 8900SM-41, 8900SM-46, 8900SM-50		
8953		
8954A		
8962, 8961		
8950N/A		

Juego de vasos 3/4", 15 piezas



8845DM

	€		
94 x 206 x 591 mm	574,59	1	8845DM

8900DM-19, 8900DM-22, 8900DM-24, 8900DM-27, 8900DM-30, 8900DM-32, 8900DM-36, 8900DM-41, 8900DM-46, 8900DM-50		
8950N/A		
8953		
8954A		
8961, 8962		

Juego de vasos 3/4", 23 piezas



8821MB

	€		
95 x 220 x 600 mm	828,15	1	8821MB

8950N/A		
8954		
8965		
8966		
8961, 8962		
8900DM-26, 8900DM-23, 8900DM-22, 8900DM-24, 8900DM-27, 8900DM-29, 8900DM-28, 8900DM-32, 8900DM-30, 8900DM-34, 8900DM-38, 8900DM-35, 8900DM-36, 8900DM-46, 8900DM-41, 8900DM-42, 8900DM-50		

Juego de vasos 3/4", 24 piezas



8840M

	€		
100 x 210 x 595 mm	1.204,85	1	8840M

8900DM-19, 8900DM-22, 8900DM-24, 8900DM-25, 8900DM-27, 8900DM-28, 8900DM-30, 8900DM-32, 8900DM-36, 8900DM-41, 8900DM-46, 8900DM-50, 8900DM-55, 8900DM-60		
8953		
8950N/A		
8951		
8954A		
8958A		
8962, 8961		
8966		
8965		
8172		

Juego de vasos 1", mm



9540MB

	€		
210 x 560 x 120 mm	1.154,73	1	9540MB

9500SM-80, 9500SM-75, 9500SM-70, 9500SM-65, 9500SM-60, 9500SM-55, 9500SM-50, 9500SM-46		
9550AB		
9555		
9560AB, 9563AB		

Juego de vasos 1", mm, 18 piezas



9540MBL

	€		
225 x 605 x 120 mm	1.707,50	1	9540MBL

9500SM-80, 9500SM-77, 9500SM-71, 9500SM-70, 9500SM-67, 9500SM-65, 9500SM-63, 9500SM-60, 9500SM-75, 9500SM-46, 9500SM-50, 9500SM-54, 9500SM-55, 9500SM-58		
9550AB		
9560AB, 9563AB		
9555		



Juego de 12 vasos bi-hexagonal 1", en pulgadas



9540DZ

€	Icono	Icono
150 x 260 x 670 mm	1.358,07	1 9540DZ

9550AB	
9555	
9563AB, 9560AB	
9500DZ-2.3/4, 9500DZ-2.3/8, 9500DZ-2.3/16, 9500DZ-3, 9500DZ-1.13/16, 9500DZ-3.1/8, 9500DZ-2.5/8, 9500DZ-2	

Juego de 19 vasos bi-hexagonal 1", en pulgadas



9540DZL

€	Icono	Icono
140 x 285 x 630 mm	1.858,94	1 9540DZL

9500DZ-2.1/4, 9500DZ-2.3/4, 9500DZ-2.3/8, 9500DZ-2.1/2, 9500DZ-2.15/16, 9500DZ-2.1/8, 9500DZ-1.7/8, 9500DZ-2.3/16, 9500DZ-3, 9500DZ-1.13/16, 9500DZ-3.1/8, 9500DZ-2.5/8, 9500DZ-2, 9500DZ-2.9/16	
9550AB	
9555	
9563AB, 9560AB	
9565AB	

1/4"

Vaso 1/4", hexagonal, mm



6700SM

€	Icono	Icono
4 mm	5,13	5 6700SM-4
4.5 mm	5,13	5 6700SM-4.5
5 mm	5,13	5 6700SM-5
5.5 mm	5,13	5 6700SM-5.5
6 mm	5,13	5 6700SM-6
7 mm	5,13	5 6700SM-7
8 mm	5,13	5 6700SM-8
9 mm	5,13	5 6700SM-9
10 mm	5,13	5 6700SM-10
11 mm	5,13	5 6700SM-11
12 mm	5,13	5 6700SM-12
13 mm	5,13	5 6700SM-13
14 mm	5,13	5 6700SM-14
4 mm	5,84	1 SB6700SM-4
4.5 mm	5,84	1 SB6700SM-4.5
5 mm	5,84	1 SB6700SM-5
5.5 mm	5,84	1 SB6700SM-5.5
6 mm	5,84	1 SB6700SM-6
7 mm	5,84	1 SB6700SM-7
8 mm	5,84	1 SB6700SM-8
9 mm	5,84	1 SB6700SM-9
10 mm	5,84	1 SB6700SM-10
11 mm	5,84	1 SB6700SM-11
12 mm	5,84	1 SB6700SM-12
13 mm	5,84	1 SB6700SM-13
14 mm	5,84	1 SB6700SM-14

SB: Embalaje en blister con información del producto

Vaso, hexagonal 1/4", pulgadas



6700SZ

€	Icono	Icono
1/8 in	5,21	5 6700SZ-1/8
5/32 in	5,21	5 6700SZ-5/32
3/16 in	5,21	5 6700SZ-3/16
7/32 in	5,21	5 6700SZ-7/32
1/4 in	5,21	5 6700SZ-1/4
9/32 in	5,21	5 6700SZ-9/32
5/16 in	5,21	5 6700SZ-5/16
11/32 in	5,21	5 6700SZ-11/32
3/8 in	5,21	5 6700SZ-3/8
7/16 in	5,21	5 6700SZ-7/16
1/2 in	5,21	5 6700SZ-1/2

€	Icono	Icono
9/16 in	5,21	5 6700SZ-9/16
1/8 in	5,89	5 SB6700SZ-1/8
5/32 in	5,89	1 SB6700SZ-5/32
3/16 in	5,89	1 SB6700SZ-3/16
7/32 in	5,89	1 SB6700SZ-7/32
1/4 in	5,89	1 SB6700SZ-1/4
9/32 in	5,89	1 SB6700SZ-9/32
5/16 in	5,89	1 SB6700SZ-5/16
11/32 in	5,89	1 SB6700SZ-11/32
3/8 in	5,89	1 SB6700SZ-3/8
7/16 in	5,89	1 SB6700SZ-7/16
1/2 in	5,89	1 SB6700SZ-1/2
9/16 in	5,89	1 SB6700SZ-9/16

SB: Embalaje en blister con información del producto

Vaso TORX® hembra 1/4"



6700TORX-E

€	Icono	Icono
E4	6,87	5 6700TORX-E4
E5	6,87	5 6700TORX-E5
E6	6,87	5 6700TORX-E6
E7	6,87	5 6700TORX-E7
E8	6,87	5 6700TORX-E8
E10	6,87	5 6700TORX-E10
E4	7,55	1 SB6700TORX-E4
E5	7,55	1 SB6700TORX-E5
E6	7,55	1 SB6700TORX-E6
E7	7,55	1 SB6700TORX-E7
E8	7,55	1 SB6700TORX-E8
E10	7,55	1 SB6700TORX-E10

SB: Embalaje en blister con información del producto

Vasos para refrigeración



R6810M

€	Icono	Icono
3.4 mm	11,56	5 R6810M-3,4
4 mm	11,56	5 R6810M-4
4.5 mm	11,56	5 R6810M-4,5
5 mm	11,81	5 R6810M-5
6 mm	11,81	5 R6810M-6
7 mm	12,07	1 R6810M-7
8 mm	12,75	5 R6810M-8
9 mm	12,75	5 R6810M-9
10 mm	13,57	5 R6810M-10

Vasos para refrigeración, pulgadas



R6810Z

	€		
3/16 in	11,82	1	R6810Z-3/16
7/32 in	11,82	1	R6810Z-7/32
1/4 in	11,82	1	R6810Z-1/4
5/16 in	14,38	1	R6810Z-5/16
3/8 in	14,38	1	R6810Z-3/8

Adaptador para refrigeración, 1/4"



R6822Z

	€		
	14,39	5	R6822Z

Adaptador de hembra a hembra, 1/4"



R6967

	€		
1/4	13,51	5	R6967

Adaptador de macho a macho, 1/4"



R6964A

	€		
	6,40	1	R6964A

Vaso bihexagonal 1/4" mm



A6700DM

	€		
5 mm	5,13	5	A6700DM-5
5.5 mm	5,13	5	A6700DM-5.5
6 mm	5,13	5	A6700DM-6
7 mm	5,13	5	A6700DM-7
8 mm	5,13	5	A6700DM-8
9 mm	5,13	5	A6700DM-9
10 mm	5,13	5	A6700DM-10
11 mm	5,13	5	A6700DM-11
12 mm	5,13	5	A6700DM-12
13 mm	5,13	5	A6700DM-13
14 mm	5,13	5	A6700DM-14
5 mm	5,80	1	SBA6700DM-5
5.5 mm	5,80	1	SBA6700DM-5.5
6 mm	5,80	1	SBA6700DM-6
7 mm	5,80	1	SBA6700DM-7
8 mm	5,80	1	SBA6700DM-8
9 mm	5,80	1	SBA6700DM-9
10 mm	5,80	1	SBA6700DM-10
11 mm	5,80	1	SBA6700DM-11
12 mm	5,80	1	SBA6700DM-12
13 mm	5,80	1	SBA6700DM-13
14 mm	5,80	1	SBA6700DM-14

SB: Embalaje en blister con información del producto

Vaso, bihexagonal 1/4" pulgadas



A6700DZ

	€		
3/16 in	6,50	5	A6700DZ-3/16
7/32 in	6,50	5	A6700DZ-7/32
1/4 in	6,50	5	A6700DZ-1/4

	€		
9/32 in	6,50	5	A6700DZ-9/32
5/16 in	6,50	5	A6700DZ-5/16
11/32 in	6,50	5	A6700DZ-11/32
3/8 in	6,58	5	A6700DZ-3/8
7/16 in	6,58	5	A6700DZ-7/16
1/2 in	6,58	5	A6700DZ-1/2
9/16 in	6,58	5	A6700DZ-9/16
3/16 in	7,16	1	SBA6700DZ-3/16
7/32 in	7,16	1	SBA6700DZ-7/32
1/4 in	7,16	1	SBA6700DZ-1/4
9/32 in	7,16	1	SBA6700DZ-9/32
5/16 in	7,16	1	SBA6700DZ-5/16
11/32 in	7,16	1	SBA6700DZ-11/32
3/8 in	7,25	1	SBA6700DZ-3/8
7/16 in	7,25	1	SBA6700DZ-7/16
1/2 in	7,25	1	SBA6700DZ-1/2
9/16 in	7,25	1	SBA6700DZ-9/16

SB: Embalaje en blister con información del producto

Vaso 1/4" Bihex serie larga, mm



A6800DM

	€		
4 mm	12,05	1	A6800DM-4
5 mm	12,05	1	A6800DM-5
5.5 mm	12,05	1	A6800DM-5.5
6 mm	12,05	1	A6800DM-6
7 mm	12,05	1	A6800DM-7
8 mm	12,05	1	A6800DM-8
9 mm	12,05	1	A6800DM-9
10 mm	12,05	1	A6800DM-10
11 mm	12,05	1	A6800DM-11
12 mm	12,05	1	A6800DM-12
13 mm	12,05	1	A6800DM-13
14 mm	12,05	1	A6800DM-14
4 mm	12,73	1	SBA6800DM-4
5 mm	12,73	1	SBA6800DM-5
5.5 mm	12,73	1	SBA6800DM-5.5
6 mm	12,73	1	SBA6800DM-6
7 mm	12,73	1	SBA6800DM-7
8 mm	12,73	1	SBA6800DM-8
9 mm	12,73	1	SBA6800DM-9
10 mm	12,73	1	SBA6800DM-10
11 mm	12,73	1	SBA6800DM-11
12 mm	12,73	1	SBA6800DM-12
13 mm	12,73	1	SBA6800DM-13
14 mm	12,73	1	SBA6800DM-14

SB: Embalaje en blister con información del producto



Vaso hexagonal largo 1/4"



A6800SM

€	Icon	Icon
4 mm	11,87	1 A6800SM-4
4.5 mm	11,87	1 A6800SM-4.5
5 mm	11,87	1 A6800SM-5
6 mm	11,87	1 A6800SM-6
7 mm	11,87	1 A6800SM-7
8 mm	11,87	1 A6800SM-8
9 mm	11,87	1 A6800SM-9
10 mm	11,87	1 A6800SM-10
11 mm	11,87	1 A6800SM-11
12 mm	11,87	1 A6800SM-12
13 mm	11,87	1 A6800SM-13
14 mm	11,87	1 A6800SM-14
15 mm	11,87	1 A6800SM-15

SB: Embalaje en blíster con información del producto

Vaso 1/4" hexagonal, serie larga, en pulgadas



A6800SZ

€	Icon	Icon
1/8 in	15,26	1 A6800SZ-1/8
5/32" in	15,26	1 A6800SZ-5/32

Vaso 1/4" Bihex serie larga, pulgadas



A6800DZ

€	Icon	Icon
3/16 in	14,56	1 A6800DZ-3/16
7/32 in	14,56	1 A6800DZ-7/32
1/4 in	14,56	1 A6800DZ-1/4
9/32 in	14,56	1 A6800DZ-9/32
5/16 in	14,56	1 A6800DZ-5/16
11/32 in	14,56	1 A6800DZ-11/32
3/8 in	14,56	1 A6800DZ-3/8
7/16 in	14,56	1 A6800DZ-7/16

€	Icon	Icon
1/2 in	14,56	1 A6800DZ-1/2
9/16 in	14,56	1 A6800DZ-9/16
3/16 in	15,23	1 SBA6800DZ-3/16
7/32 in	15,23	1 SBA6800DZ-7/32
1/4 in	15,23	1 SBA6800DZ-1/4
9/32 in	15,23	1 SBA6800DZ-9/32
5/16 in	15,23	1 SBA6800DZ-5/16
11/32 in	15,23	1 SBA6800DZ-11/32
3/8 in	15,23	1 SBA6800DZ-3/8
7/16 in	15,23	1 SBA6800DZ-7/16
1/2 in	15,23	1 SBA6800DZ-1/2
9/16 in	15,23	1 SBA6800DZ-9/16

SB: Embalaje en blíster con información del producto

Vaso articulado 1/4", bihexagonal, mm



A6710DM

€	Icon	Icon
5.5 mm	41,58	1 A6710DM-5.5
6 mm	41,58	1 A6710DM-6
7 mm	41,58	1 A6710DM-7
8 mm	41,58	1 A6710DM-8
9 mm	41,58	1 A6710DM-9
10 mm	41,58	1 A6710DM-10
11 mm	42,25	1 A6710DM-11
12 mm	42,25	1 A6710DM-12
13 mm	42,25	1 A6710DM-13
14 mm	42,25	1 A6710DM-14

Vaso articulado, cuadrado 1/4"



A6710DZ

€	Icon	Icon
3/16 in	42,25	1 A6710DZ-3/16
7/32 in	42,25	1 A6710DZ-7/32
1/4 in	42,25	1 A6710DZ-1/4
9/32 in	42,25	1 A6710DZ-9/32
5/16 in	42,25	1 A6710DZ-5/16
11/32 in	42,25	1 A6710DZ-11/32
3/8 in	42,25	1 A6710DZ-3/8
7/16 in	42,49	1 A6710DZ-7/16
1/2 in	42,49	1 A6710DZ-1/2
9/16 in	42,49	1 A6710DZ-9/16

Mango articulado, 1/4"



6958

€	Icon	Icon
153 mm	21,58	1 6958-6
153 mm	43,05	1 SB6958-6

SB: Embalaje en blíster con información del producto

Mango corredizo en T de 1/4"



6954

€	Icon	Icon
125 mm	11,63	1 6954
125 mm	12,31	10 SB6954-5

SB: Embalaje en blíster con información del producto

Destornillador portavasos 1/4"



6956

€	Icon	Icon
150 mm	12,02	10 6956
150 mm	12,70	1 SB6956

SB: Embalaje en blíster con información del producto

Alargadera 1/4"



6960 - 6962L

L	€		
26 mm	7,71	1	696EX-01
50 mm	8,98	1	6960
75 mm	9,27	10	6960-3
101 mm	10,43	1	6961
152 mm	12,46	1	6962
152 mm	9,30	1	696EX-06
200 mm	12,82	1	696EX-08
276 mm	14,14	1	696EX-11
355 mm	29,85	1	6962L
53 mm	10,31	1	SB6960
75 mm	12,23	1	SB6960-3
101 mm	11,83	1	SB6961
152 mm	13,93	1	SB6962
355 mm	30,54	1	SB6962L

SB: Clip para colgar (blister)

Alargadera angular de 1/4"



6960-W - 6962-W

L	€		
50 mm	11,02	10	6960W-2
100 mm	12,86	1	6960W-4
150 mm	14,70	10	6960W-6

Alargadera flexible de 1/4"



6963

L	€		
148 mm	20,58	1	SB6963
150 mm	9,86	20	6960F-6

SB: Clip para colgar (blister)

Articulación universal de 1/4"



6966

L	€		
35 mm	23,63	10	6966
35 mm	24,31	1	SB6966

SB: Embalaje en blíster con información del producto

Articulación universal de 1/4", funcionamiento fluido



6968

L	€		
35 mm	30,09	1	6968

Amplificador entrada 1/4" a salida 3/8"



7765

		€		
1/4	3/8	10,24	1	7765
1/4	3/8	10,38	1	SB7765

SB: Clip para colgar

Adaptador 1/4" para puntas 1/4"



6709HL

	€		
1/4 in	9,70	1	6709HL

Adaptador portapuntas hexagonal 1/4"



6972H

		€		
1/4" in	1/4"	22,59	5	6972H

Adaptador 1/4" para puntas 1/4"



6973M

		€		
1/4"	1/4" in	6,69	1	6973M



Adaptador 1/4" para puntas 1/4"



6973A

	€		
1/4 in	7,29	10	6973A
1/4 in	5,85	1	SB6973A

SB: Embalaje en blister con información del producto

Adaptadores planos de 1/4" a 1/4"



6969

	€		
1/4	1,34	1	6969

Aumentador plano de entrada 1/4" a salida 3/8"



7767

	€		
1/4	24,17	1	7767
1/4	24,85	1	SB7767

SB: Embalaje en blister con información del producto

Juego de aumentadores planos
7767,8167,8967



8967/S3

	€		
110 x 194 x 30 mm	85,14	1	8967/S3

7767	
8167	
8967	

Regleta para vasos



RAIL-187/264/340

	€		
203 mm	2,58	10	RAIL-8
250 mm	2,84	10	RAIL-10
340 mm	3,21	3	RAIL-340

Clips 1/4"



C1/4

	€		
17 mm	0,37	25	CLIPS-1/4

Vasos con puntas recta 1/4"



6709F

	€		
0.6 mm	4.5 mm	6,81	5 6709F-4.5
0.8 mm	5.5 mm	6,81	5 6709F-5.5
0.9 mm	6.5 mm	6,81	5 6709F-6.5
1.2 mm	8 mm	6,81	5 6709F-8
0.6 mm	4.5 mm	7,51	1 SB6709F-4.5
0.8 mm	5.5 mm	7,51	1 SB6709F-5.5
0.9 mm	6.5 mm	7,52	1 SB6709F-6.5
1.2 mm	8 mm	7,51	1 SB6709F-8

SB: Embalaje en blister con información del producto

Vasos con puntas Phillips 1/4"



6709PH

	€		
1	7,45	5	6709PH-1
2	7,45	5	6709PH-2
3	7,45	5	6709PH-3
1	8,14	1	SB6709PH-1
2	8,14	1	SB6709PH-2
3	8,14	1	SB6709PH-3

SB: Embalaje en blister con información del producto

Vasos con puntas Pozidriv 1/4"



6709PZ

	€		
1	7,91	5	6709PZ-1
2	7,91	5	6709PZ-2
3	7,91	5	6709PZ-3

	€		
1	8,58	1	SB6709PZ-1
2	8,58	1	SB6709PZ-2
3	8,58	1	SB6709PZ-3

SB: Embalaje en blister con información del producto

Vasos con punta TORX® 1/4"



6709TORX

	€		
T6	8,09	5	6709TORX-T6
T7	8,09	5	6709TORX-T7
T8	8,39	5	6709TORX-T8
T9	8,39	5	6709TORX-T9
T10	8,39	5	6709TORX-T10
T15	8,39	5	6709TORX-T15
T20	8,39	5	6709TORX-T20
T25	8,67	5	6709TORX-T25
T27	8,67	5	6709TORX-T27
T30	8,67	5	6709TORX-T30
T40	8,67	5	6709TORX-T40
T8	9,07	1	SB6709TORX-T8
T9	9,07	1	SB6709TORX-T9
T10	9,07	1	SB6709TORX-T10
T15	9,07	1	SB6709TORX-T15
T20	9,07	1	SB6709TORX-T20
T25	9,33	1	SB6709TORX-T25
T27	9,33	1	SB6709TORX-T27
T30	9,33	1	SB6709TORX-T30
T40	9,33	1	SB6709TORX-T40

SB: Embalaje en blister con información del producto

Vasos con puntas TORX® inviolable 1/4"



6709TORX-R

	€		
TR 8	8,79	1	6709TORX-R-T8
TR 10	8,79	1	6709TORX-R-T10
TR 15	8,79	1	6709TORX-R-T15
TR 20	8,79	1	6709TORX-R-T20
TR 25	9,11	1	6709TORX-R-T25
TR 8	9,46	1	SB6709TORX-R-T8
TR 10	9,46	1	SB6709TORX-R-T10

	€		
TR 15	9,46	1	SB6709TORX-R-T15
TR 20	9,46	1	SB6709TORX-R-T20
TR 25	9,79	1	SB6709TORX-R-T25

SB: Embalaje en blister con información del producto

Vaso cuadradillo 1/4" con puntas TORX PLUS® 1/4"



6709-IP

		€		
IP6		8,39	1	6709-IP6
IP7		8,39	1	6709-IP7
IP8		8,71	1	6709-IP8
IP9		8,71	1	6709-IP9
IP10	M3	8,77	1	6709-IP10
IP15	-	8,77	1	6709-IP15
IP20	M4	8,77	1	6709-IP20
IP25	M5	9,10	1	6709-IP25
IP27	-	8,77	1	6709-IP27
IP30	M6	8,39	1	6709-IP30
IP40	M8	10,46	1	6709-IP40
IP45	-	10,46	1	6709-IP45

SB: Embalaje en blister

Vasos con puntas hexagonales 1/4"



6709M

	€		
3 mm	6,74	5	6709M-3
4 mm	6,74	5	6709M-4
5 mm	6,74	5	6709M-5
6 mm	6,74	5	6709M-6
8 mm	6,74	5	6709M-8
10 mm	6,73	5	6709M-10
3 mm	3,50	1	SBS67M-3
4 mm	7,41	1	SB6709M-4
5 mm	7,41	1	SB6709M-5
6 mm	7,41	1	SB6709M-6
8 mm	7,41	1	SB6709M-8

SB: Embalaje en blister con información del producto

Vaso con punta hex 1/4" serie larga, mm



A6709M

	€		
2.5 mm	31,94	1	A6709M-2.5
3 mm	31,94	1	A6709M-3
4 mm	31,94	1	A6709M-4
5 mm	31,94	1	A6709M-5
6 mm	31,94	1	A6709M-6
2.5 mm	32,79	1	SBA6709M-2.5
3 mm	32,79	1	SBA6709M-3
4 mm	32,79	1	SBA6709M-4
5 mm	32,62	1	SBA6709M-5
6 mm	32,62	1	SBA6709M-6

SB: Embalaje en blister con información del producto

Vaso con punta hex 1/4" serie larga, pulgadas



A6709Z

	€		
1/8 in	31,94	1	A6709Z-1/8
9/64 in	31,94	1	A6709Z-9/64
5/32 in	31,94	1	A6709Z-5/32
3/16 in	31,94	1	A6709Z-3/16
1/8 in	32,62	1	SBA6709Z-1/8
9/64 in	32,62	1	SBA6709Z-9/64
5/32 in	32,62	1	SBA6709Z-5/32
3/16 in	32,62	1	SBA6709Z-3/16

SB: Embalaje en blister con información del producto



Llave de carraca 1/4" con bloqueo 72
dientes



6950SL

		€		
119 mm	72	41,21	1	6950SL

Cabeza reducida

Llave de carraca reversible 1/4" 72 dientes
5° ángulo de acción



6950

		€		
121 mm	72	40,82	1	6950
121 mm	72	41,54	1	SB6950

SB=embalaje en blister

Llave de carraca reversible, 1/4" 72
dientes/5° ángulo de acción



6950RN

		€		
121 mm	72	36,99	1	6950RN
121 mm	72	37,63	1	SB6950RN

SB=embalaje en blister

Llave de carraca reversible para válvulas
de refrigeración



R6950

		€		
160 mm	32	104,43	1	R6950



Llave de carraca 1/4" con cabeza giratoria



8120-1/4

		€		
149 mm	72	38,34	20	8120-1/4

Llave de carraca reversible 1/4"



SBS61

		€		
145 mm	60	24,24	1	SBS61

SB: Embalaje en blister

Llaves combinadas de carraca para
puntas de destornillador



2058-BR

	€		
52	10,24	1	2058-BR

Llave de carraca 1/4" reversible



SBS61S

		€		
120 mm	60	23,40	1	SBS61S

SB: Embalaje en blister

Adaptador para llave de carraca 1/4"



6951

	€		
40 mm	80,43	1	6951

60 dientes / Ángulo de acción de 6°

Kit de reparación para carraca 1/4"
6950SL



6950SL-SPARE

Icon	Search	€	Box	Fish
10	6950SL	17,63	1	6950SL-SPARE

Kit de reparación para carraca 1/4" - 6950



6950-SPARE

Icon	Search	€	Box	Fish
12	6950	18,13	1	6950-SPARE

Kit de reparación para carraca 1/4 6950RN



6950RN-SPARE

Icon	Search	€	Box	Fish
6	6950RN	17,41	1	6950RN-SPARE

3/8"

Vaso hexagonal 3/8", mm



7400SM

Icon	€	Box	Fish
6 mm	5,58	5	7400SM-6
7 mm	5,58	5	7400SM-7
8 mm	5,68	5	7400SM-8
9 mm	5,90	5	7400SM-9
10 mm	6,12	5	7400SM-10
11 mm	6,20	5	7400SM-11
12 mm	6,29	5	7400SM-12
13 mm	6,45	5	7400SM-13
14 mm	6,89	5	7400SM-14
15 mm	7,16	5	7400SM-15
16 mm	7,56	5	7400SM-16
17 mm	7,74	5	7400SM-17
18 mm	7,92	5	7400SM-18
19 mm	8,24	5	7400SM-19
20 mm	8,46	5	7400SM-20
21 mm	8,71	5	7400SM-21
22 mm	8,85	5	7400SM-22
6 mm	6,26	1	SB7400SM-6
7 mm	6,26	1	SB7400SM-7
8 mm	6,36	1	SB7400SM-8
9 mm	6,58	1	SB7400SM-9
10 mm	6,79	1	SB7400SM-10
11 mm	6,87	1	SB7400SM-11
12 mm	6,98	1	SB7400SM-12
13 mm	7,12	1	SB7400SM-13
14 mm	7,56	1	SB7400SM-14
15 mm	7,85	1	SB7400SM-15
16 mm	8,23	1	SB7400SM-16
17 mm	8,40	1	SB7400SM-17
18 mm	8,60	1	SB7400SM-18
19 mm	8,93	1	SB7400SM-19
20 mm	9,14	1	SB7400SM-20
21 mm	9,38	1	SB7400SM-21
22 mm	9,53	1	SB7400SM-22

SB: Embalaje en blíster con información del producto

Vaso bihexagonal 3/8", mm



A7400DM

Icon	€	Box	Fish
6 mm	7,44	5	A7400DM-6
7 mm	7,44	5	A7400DM-7
8 mm	7,44	5	A7400DM-8

Icon	€	Box	Fish
9 mm	7,44	5	A7400DM-9
10 mm	7,44	5	A7400DM-10
11 mm	7,44	5	A7400DM-11
12 mm	7,44	5	A7400DM-12
13 mm	7,44	5	A7400DM-13
14 mm	7,44	5	A7400DM-14
15 mm	7,55	5	A7400DM-15
16 mm	7,55	5	A7400DM-16
17 mm	7,55	5	A7400DM-17
18 mm	7,55	5	A7400DM-18
19 mm	7,55	5	A7400DM-19
20 mm	7,55	5	A7400DM-20
21 mm	7,64	5	A7400DM-21
22 mm	7,64	5	A7400DM-22
24 mm	8,06	5	A7400DM-24
6 mm	8,11	1	SBA7400DM-6
7 mm	8,11	1	SBA7400DM-7
8 mm	8,11	1	SBA7400DM-8
9 mm	8,11	1	SBA7400DM-9
10 mm	8,11	1	SBA7400DM-10
11 mm	8,11	1	SBA7400DM-11
12 mm	8,11	1	SBA7400DM-12
13 mm	8,11	1	SBA7400DM-13
14 mm	8,11	1	SBA7400DM-14
15 mm	8,22	1	SBA7400DM-15
16 mm	8,22	1	SBA7400DM-16
17 mm	8,22	1	SBA7400DM-17
18 mm	8,22	1	SBA7400DM-18
19 mm	8,22	1	SBA7400DM-19
20 mm	8,22	1	SBA7400DM-20
21 mm	8,31	1	SBA7400DM-21
22 mm	8,31	1	SBA7400DM-22

SB: Embalaje en blíster con información del producto

Vaso hexagonal 3/8", pulgadas



7400SZ

Icon	€	Box	Fish
1/4" in	7,22	1	7400SZ-1/4
5/16" in	7,22	1	7400SZ-5/16
11/32" in	7,45	1	7400SZ-11/32
3/8" in	7,22	1	7400SZ-3/8
7/16" in	7,34	1	7400SZ-7/16
1/2" in	7,34	1	7400SZ-1/2
9/16" in	7,34	1	7400SZ-9/16
5/8" in	7,45	1	7400SZ-5/8
11/16" in	7,45	1	7400SZ-11/16
3/4" in	7,45	1	7400SZ-3/4
13/16" in	7,45	1	7400SZ-13/16
7/8" in	7,45	1	7400SZ-7/8



Vaso bihexagonal 3/8", pulgadas



A7400DZ

Ø	€	SB	QTY	Part No.
1/4 in	8,10	5	A7400DZ-1/4	
5/16 in	8,10	5	A7400DZ-5/16	
3/8 in	8,10	5	A7400DZ-3/8	
7/16 in	8,24	5	A7400DZ-7/16	
1/2 in	8,24	5	A7400DZ-1/2	
17/32 in	8,24	5	A7400DZ-17/32	
9/16 in	8,24	5	A7400DZ-9/16	
19/32 in	8,24	5	A7400DZ-19/32	
5/8 in	8,36	5	A7400DZ-5/8	
11/16 in	8,36	5	A7400DZ-11/16	
3/4 in	8,36	5	A7400DZ-3/4	
13/16 in	8,36	5	A7400DZ-13/16	
7/8 in	8,36	5	A7400DZ-7/8	
1/4 in	8,79	1	SBA7400DZ-1/4	
5/16 in	8,79	1	SBA7400DZ-5/16	
3/8 in	8,79	1	SBA7400DZ-3/8	
7/16 in	8,93	1	SBA7400DZ-7/16	
1/2 in	8,93	1	SBA7400DZ-1/2	
17/32 in	8,93	1	SBA7400DZ-17/32	
9/16 in	8,93	1	SBA7400DZ-9/16	
19/32 in	8,93	1	SBA7400DZ-19/32	
5/8 in	9,04	1	SBA7400DZ-5/8	
11/16 in	9,04	1	SBA7400DZ-11/16	
3/4 in	9,04	1	SBA7400DZ-3/4	
13/16 in	9,04	1	SBA7400DZ-13/16	
7/8 in	9,04	1	SBA7400DZ-7/8	

SB: Embalaje en blister con información del producto

Vaso articulado bihexagonal 3/8", pulgadas



A7410DZ

Ø	€	SB	QTY	Part No.
5/16 in	39,41	1	A7410DZ-5/16	
3/8 in	40,80	1	A7410DZ-3/8	
7/16 in	40,80	1	A7410DZ-7/16	
1/2 in	40,80	1	A7410DZ-1/2	
9/16 in	40,80	1	A7410DZ-9/16	
5/8 in	45,55	1	A7410DZ-5/8	
11/16 in	45,55	1	A7410DZ-11/16	
3/4 in	45,55	1	A7410DZ-3/4	

Vaso bihexagonal 3/8" serie larga, mm



A7402DM

Ø	€	SB	QTY	Part No.
7 mm	14,91	1	A7402DM-7	
8 mm	14,91	1	A7402DM-8	
9 mm	14,92	1	A7402DM-9	
10 mm	14,92	5	A7402DM-10	
11 mm	14,92	1	A7402DM-11	
12 mm	14,92	1	A7402DM-12	
13 mm	14,92	1	A7402DM-13	
14 mm	15,61	1	A7402DM-14	
15 mm	15,61	1	A7402DM-15	
16 mm	15,61	1	A7402DM-16	
17 mm	16,64	1	A7402DM-17	
18 mm	16,64	1	A7402DM-18	
19 mm	16,64	1	A7402DM-19	
21 mm	17,02	1	A7402DM-21	
7 mm	15,58	1	SBA7402DM-7	
8 mm	15,58	1	SBA7402DM-8	
9 mm	15,60	1	SBA7402DM-9	
10 mm	15,60	1	SBA7402DM-10	
11 mm	15,60	1	SBA7402DM-11	
12 mm	15,60	1	SBA7402DM-12	
13 mm	15,60	1	SBA7402DM-13	
14 mm	16,27	1	SBA7402DM-14	
15 mm	16,27	1	SBA7402DM-15	
16 mm	16,27	1	SBA7402DM-16	
17 mm	17,33	1	SBA7402DM-17	
18 mm	17,33	1	SBA7402DM-18	
19 mm	17,33	1	SBA7402DM-19	

SB: Embalaje en blister con información del producto

Vaso bihexagonal 3/8" serie larga, pulgadas



A7402DZ

Ø	€	SB	QTY	Part No.
1/4 in	16,76	1	A7402DZ-1/4	
5/16 in	16,76	1	A7402DZ-5/16	
3/8 in	16,76	1	A7402DZ-3/8	
7/16 in	16,76	1	A7402DZ-7/16	
1/2 in	16,76	1	A7402DZ-1/2	
9/16 in	16,76	1	A7402DZ-9/16	
19/32 in	16,76	1	A7402DZ-19/32	
5/8 in	16,76	1	A7402DZ-5/8	
11/16 in	16,76	1	A7402DZ-11/16	
3/4 in	16,76	1	A7402DZ-3/4	
13/16 in	16,76	1	A7402DZ-13/16	

Ø	€	SB	QTY	Part No.
7/8 in	16,76	1	A7402DZ-7/8	
1/4 in	17,41	1	SBA7402DZ-1/4	
5/16 in	17,41	1	SBA7402DZ-5/16	
3/8 in	17,41	1	SBA7402DZ-3/8	
7/16 in	17,41	1	SBA7402DZ-7/16	
1/2 in	17,41	1	SBA7402DZ-1/2	
9/16 in	17,41	1	SBA7402DZ-9/16	
19/32 in	17,41	1	SBA7402DZ-19/32	
5/8 in	17,41	1	SBA7402DZ-5/8	
11/16 in	17,41	1	SBA7402DZ-11/16	
3/4 in	17,41	1	SBA7402DZ-3/4	
13/16 in	17,41	1	SBA7402DZ-13/16	
7/8 in	17,41	1	SBA7402DZ-7/8	

SB: Embalaje en blister con información del producto

Vaso TORX® hembra 3/8"



7400TORX-E

Ø	€	SB	QTY	Part No.
E8	10,88	5	7400TORX-E8	
E10	10,88	5	7400TORX-E10	
E11	10,88	5	7400TORX-E11	
E12	10,88	5	7400TORX-E12	
E14	11,89	5	7400TORX-E14	
E16	11,89	5	7400TORX-E16	
E18	12,48	5	7400TORX-E18	
E8	11,57	1	SB7400TORX-E8	
E10	11,57	1	SB7400TORX-E10	
E11	11,57	1	SB7400TORX-E11	
E12	11,57	1	SB7400TORX-E12	
E14	12,56	1	SB7400TORX-E14	
E16	12,56	1	SB7400TORX-E16	
E18	13,15	1	SB7400TORX-E18	

SB: Embalaje en blister con información del producto

Berbiquí 3/8" con mango de acero giratorio



7752

L	€	SB	QTY	Part No.
435 mm	46,86	1	7752	

Mango articulado 3/8"



7758

L	€		
250 m	29,03	1	7758-10
250 m	30,48	1	SB7758-10

SB: Embalaje en blister con información del producto

Mango corredizo en T 3/8"



7754

L	€		
160 mm	18,09	1	7754
160 mm	18,77	1	SB7754

SB: Embalaje en blister con información del producto

Destornillador portavasos 3/8"



7756

L	€		
150 mm	18,36	6	7756
150 mm	18,93	1	SB7756

SB: Clip para colgar

Alargadera de 3/8"



7760-7761-7762

L	€		
75 mm	12,84	1	7760
127 mm	15,37	1	7761
250 mm	19,01	1	7762
75 mm	13,72	1	SB7760
127 mm	16,19	1	SB7761
252 mm	19,90	1	SB7762

SB: Clip para colgar

Alargadera angular 3/8"



7760-W - 7761-W

L	€		
75 mm	11,19	10	7760W-3
150 mm	12,44	10	7760W-6

SB: Clip para colgar

Alargadera de 3/8" con moleteado



776EX

L	€		
26 mm	12,20	1	776EX-01
76 mm	12,20	1	776EX-03
101 mm	14,05	1	776EX-04
150 mm	15,22	1	776EX-06
200 mm	15,90	1	776EX-08
275 mm	16,91	1	776EX-11

SB: Clip para colgar

Alargadera flexible de 3/8"

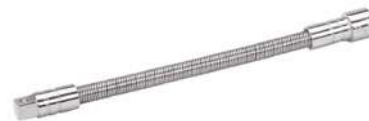

7759

L	€		
200 mm	40,59	1	7759
200 mm	41,27	1	SB7759

SB: Clip para colgar

Articulación universal 3/8"



7766

L	€		
51.5 mm	29,34	1	7766
51.5 mm	30,00	1	SB7766

SB: Embalaje en blister con información del producto

Articulación universal 3/8", funcionamiento fluido



7768

L	€		
45 mm	41,54	1	7768



Reductor de entrada 3/8" y salida 1/4"



7764

Icon	Icon	€	Icon	Icon
		12,29	1	7764
3/8	1/4	12,97	1	SB7764

Este producto no está garantizado contra la rotura del cuadrado macho

Adaptador 3/8" para puntas 1/4"



SBS780

Icon	€	Icon	Icon
	2,99	20	7773A
1/4 in	2,32	1	SB7773A

SB: Presentación con colgador

Llave de carraca 3/8" cabeza delgada 72 dientes



7750SL

Icon	Icon	€	Icon	Icon
		58,52	1	7750SL
204 mm	72			

Amplificador de entrada 3/8" a salida 1/2"



8164-1/2

Icon	Icon	€	Icon	Icon
		12,29	1	8164-1/2
3/8"	1/2"			

Adaptador 3/8" para puntas 5/16"



7106J

Icon	€	Icon	Icon
	8,53	1	7106J
5/16 in			

Llave de carraca reversible 3/8"



7750

Icon	Icon	€	Icon	Icon
		55,34	1	7750
207 mm	80	58,94	1	SB7750
207 mm	80			

SB: Con clip para colgar

Aumentador magnético de 3/8" a 1/2"



8167

Icon	Icon	€	Icon	Icon
		28,35	1	8167
3/8	1/2			

Railes y clips para vasos 3/8"



C3/8

Icon	€	Icon	Icon
	0,37	25	CLIPS-3/8
19 mm			

Llave de carraca reversible, 3/8"



7750RN

Icon	Icon	€	Icon	Icon
		52,45	1	7750RN
206 mm	72	53,14	1	SB7750RN
206 mm	72			

SB- Clip para colgar

Llave de carraca reversible 3/8"



SBS750

		€		
200 mm	60	33,63	10	SBS750

SB: Embalaje en blister

Carraca 3/8" con cabeza giratoria



8120-3/8

		€		
223 mm	72	46,69	10	8120-3/8

Llave de carraca articulada 3/8" reversible



7710

		€		
278 mm	60	76,83	1	7710

Vaso con punta recta 3/8"



7409F

	€		
6.4 mm	6,54	5	7409F-6.5
7.9 mm	6,54	5	7409F-8
9.5 mm	6,54	5	7409F-10
6.4 mm	7,24	1	SB7409F-6.5
7.9 mm	7,24	1	SB7409F-8
9.5 mm	7,24	1	SB7409F-10

SB: Embalaje en blister con información del producto

Vaso con punta Phillips 3/8"



7409PH

	€		
1	6,89	5	7409PH-1
2	6,89	5	7409PH-2
3	6,89	5	7409PH-3
1	7,56	1	SB7409PH-1
2	7,56	1	SB7409PH-2
3	7,56	1	SB7409PH-3

SB: Embalaje en blister con información del producto

Vaso con punta TORX® 3/8"



7409TORX

	€		
T20	11,72	5	7409TORX-T20
T25	11,72	5	7409TORX-T25
T27	11,72	5	7409TORX-T27

	€		
T30	11,72	5	7409TORX-T30
T40	14,21	5	7409TORX-T40
T45	14,21	5	7409TORX-T45
T50	14,21	5	7409TORX-T50
T20	12,40	1	SB7409TORX-T20
T25	12,40	1	SB7409TORX-T25
T27	12,40	1	SB7409TORX-T27
T30	12,40	1	SB7409TORX-T30
T40	14,86	1	SB7409TORX-T40
T45	14,86	1	SB7409TORX-T45
T50	14,86	1	SB7409TORX-T50

SB: Embalaje en blister con información del producto

Vaso con punta TORX® inviolable, 3/8"



7409TORX-R

	€		
TR 27	13,00	5	7409TORX-R-T27
TR 30	13,00	5	7409TORX-R-T30
TR 40	15,29	5	7409TORX-R-T40
TR 45	15,60	5	7409TORX-R-T45
TR 50	16,23	5	7409TORX-R-T50
TR 27	13,68	1	SB7409TORX-R-T27
TR 30	13,68	1	SB7409TORX-R-T30
TR 40	15,98	1	SB7409TORX-R-T40
TR 45	16,25	1	SB7409TORX-R-T45
TR 50	16,93	1	SB7409TORX-R-T50

SB: Embalaje en blister con información del producto

Juego de 5 vasos con punta 3/8" 7409TORX



7409TORX-TRR/

	€		
5	25 x 55 x 190 mm	70,25	1 7409TORX-TRR/S5

7409TORX-R-T40, 7409TORX-R-T30, 7409TORX-R-T27, 7409TORX-R-T50, 7409TORX-R-T45



Vaso con punta TORX® serie larga 3/8"



7409TORX-L

	€		
T25	19,05	5	7409TORX-T25-L
T30	19,05	5	7409TORX-T30-L
T40	22,28	5	7409TORX-T40-L
T45	22,28	5	7409TORX-T45-L
T50	22,28	5	7409TORX-T50-L
T25	19,73	1	SB7409TORX-T25-L
T30	19,73	1	SB7409TORX-T30-L
T40	22,94	1	SB7409TORX-T40-L
T45	22,94	1	SB7409TORX-T45-L
T50	22,94	1	SB7409TORX-T50-L

SB: Embalaje en blister con información del producto

Vaso con punta hexagonal cuadrado 3/8", mm



7409M

	€		
3 mm	10,62	5	7409M-3
4 mm	10,62	5	7409M-4
5 mm	10,62	5	7409M-5
6 mm	10,62	5	7409M-6
7 mm	10,62	5	7409M-7
8 mm	11,63	5	7409M-8
10 mm	11,63	5	7409M-10
3 mm	11,29	1	SB7409M-3
4 mm	11,29	1	SB7409M-4
5 mm	11,29	1	SB7409M-5
6 mm	11,29	1	SB7409M-6
7 mm	11,29	1	SB7409M-7
8 mm	12,29	1	SB7409M-8
10 mm	12,29	1	SB7409M-10

SB: Embalaje en blister con información del producto

Vaso con punta hexagonal con bola 3/8"



7409BH

	€		
4 mm	11,40	5	7409BH-4
5 mm	11,40	1	7409BH-5
6 mm	11,40	5	7409BH-6

BAHCO

€

8 mm	12,36	5	7409BH-8
10 mm	14,01	5	7409BH-10
4 mm	12,06	1	SB7409BH-4
5 mm	12,06	1	SB7409BH-5
6 mm	12,06	1	SB7409BH-6
8 mm	13,03	1	SB7409BH-8
10 mm	14,68	1	SB7409BH-10

SB: Embalaje en blister con información del producto

Claves de vaso pasantes de 19 mm con perfil métrico



SBS19-TH

	€		
10 mm	5,70	1	SBS19-TH10
11 mm	5,70	1	SBS19-TH11
12 mm	5,70	1	SBS19-TH12
13 mm	5,70	1	SBS19-TH13
14 mm	5,88	1	SBS19-TH14
15 mm	5,88	1	SBS19-TH15
16 mm	5,88	1	SBS19-TH16
17 mm	6,72	1	SBS19-TH17
18 mm	6,72	1	SBS19-TH18
19 mm	6,72	1	SBS19-TH19
21 mm	7,39	1	SBS19-TH21
22 mm	7,39	1	SBS19-TH22
24 mm	7,95	1	SBS19-TH24

SB: Embalaje en blister

Portapuntas cuadradillos de 3/8", para puntas hexagonales, pulgadas



7409Z

	L	€		
1/8 in	47 mm	9,57	1	7409Z-1/8
5/32 in	47 mm	9,57	1	7409Z-5/32
3/16 in	47 mm	9,57	1	7409Z-3/16
7/32 in	47 mm	9,57	1	7409Z-7/32
1/4 in	47 mm	9,57	1	7409Z-1/4
3/8 in	50.5 mm	10,48	1	7409Z-3/8

Vaso pasante de 19 mm Extensión de 75 mm



SBS19-TH75

L	€		
75 mm	9,70	1	SBS19-TH75

Juego de vasos con punta hexagonal 3/8"



7409MR/

	€		
7 25 x 55 x 190 mm	77,17	1	7409MR/S7

7409M-3, 7409M-4, 7409M-10, 7409M-8, 7409M-7, 7409M-6, 7409M-5

Adaptador de carraca reversible 3/8"



7751

L	g	€		
55 mm	175 g	43,97	10	7751

Kit de reparación para carraca cabeza delgada 3/8" 7750SL



7750SL-SPARE

	€		
12 7750SL	18,58	1	7750SL-SPARE

Kit de reparación para carraca 3/8 7750



7750-SPARE

Icon	Search	€	Icons	Part Name
X	7750	20,43	1	7750-SPARE

Kit de reparación para carraca 3/8 7750RN



7750RN-SPARE

Icon	Search	€	Icons	Part Name
X	7750RN	17,62	1	7750RN-SPARE

1/2"

Vaso de 1/2" hexagonal, mm



7800SM

Ø	€	Icons	Part Name
8 mm	6,40	10	7800SM-8
9 mm	6,52	10	7800SM-9
10 mm	6,52	10	7800SM-10
11 mm	6,52	10	7800SM-11
12 mm	6,90	10	7800SM-12
13 mm	7,20	10	7800SM-13
14 mm	7,58	10	7800SM-14
15 mm	7,85	10	7800SM-15

Ø	€	Icons	Part Name
16 mm	8,00	10	7800SM-16
17 mm	8,32	10	7800SM-17
18 mm	8,32	10	7800SM-18
19 mm	8,64	10	7800SM-19
20 mm	9,07	10	7800SM-20
21 mm	9,12	10	7800SM-21
22 mm	9,45	10	7800SM-22
23 mm	9,93	10	7800SM-23
24 mm	10,65	10	7800SM-24
25 mm	10,82	10	7800SM-25
26 mm	11,04	10	7800SM-26
27 mm	11,34	10	7800SM-27
28 mm	12,17	10	7800SM-28
29 mm	12,64	10	7800SM-29
30 mm	12,64	10	7800SM-30
32 mm	12,89	10	7800SM-32
33 mm	11,57	10	7800SM-33
34 mm	17,25	10	7800SM-34
36 mm	24,44	10	7800SM-36
8 mm	7,58	1	SB7800SM-8
9 mm	7,72	1	SB7800SM-9
10 mm	7,72	1	SB7800SM-10
11 mm	7,72	1	SB7800SM-11
12 mm	8,06	1	SB7800SM-12
13 mm	8,36	1	SB7800SM-13
14 mm	8,73	1	SB7800SM-14
15 mm	9,01	1	SB7800SM-15
16 mm	9,18	1	SB7800SM-16
17 mm	9,50	1	SB7800SM-17
18 mm	9,50	1	SB7800SM-18
19 mm	9,82	1	SB7800SM-19
21 mm	9,77	1	SB7800SM-20
21 mm	10,29	1	SB7800SM-21
22 mm	10,60	1	SB7800SM-22
23 mm	11,10	1	SB7800SM-23
24 mm	11,81	1	SB7800SM-24
25 mm	11,98	1	SB7800SM-25
26 mm	12,20	1	SB7800SM-26
27 mm	12,53	1	SB7800SM-27
28 mm	13,35	1	SB7800SM-28
29 mm	13,35	1	SB7800SM-29
30 mm	13,81	1	SB7800SM-30
32 mm	14,08	1	SB7800SM-32
33 mm	13,59	1	SB7800SM-33
34 mm	17,93	1	SB7800SM-34
36 mm	25,12	1	SB7800SM-36

SB: Embalaje en blíster con información del producto

Vasos de 1/2" serie larga hex, mm



7805SM

Ø	€	Icons	Part Name
10 mm	17,47	10	7805SM-10
11 mm	17,47	10	7805SM-11
12 mm	17,47	10	7805SM-12
13 mm	17,47	10	7805SM-13
14 mm	18,20	10	7805SM-14

Ø	€	Icons	Part Name
15 mm	19,16	10	7805SM-15
16 mm	19,66	10	7805SM-16
17 mm	19,66	10	7805SM-17
18 mm	19,66	10	7805SM-18
19 mm	19,66	10	7805SM-19
20 mm	20,11	10	7805SM-20
21 mm	21,91	10	7805SM-21
22 mm	22,08	10	7805SM-22
23 mm	22,78	10	7805SM-23
24 mm	22,78	10	7805SM-24
25 mm	22,00	10	7805SM-25
26 mm	22,78	10	7805SM-26
27 mm	25,24	10	7805SM-27
28 mm	23,54	10	7805SM-28
29 mm	25,12	10	7805SM-29
30 mm	26,99	10	7805SM-30
32 mm	29,20	10	7805SM-32
34 mm	29,20	10	7805SM-34
10 mm	18,14	1	SB7805SM-10
11 mm	12,51	1	SB7805SM-11
12 mm	18,14	1	SB7805SM-12
13 mm	18,14	1	SB7805SM-13
14 mm	18,88	1	SB7805SM-14
15 mm	19,85	1	SB7805SM-15
16 mm	20,34	1	SB7805SM-16
17 mm	20,34	1	SB7805SM-17
18 mm	20,34	1	SB7805SM-18
19 mm	20,34	1	SB7805SM-19
20 mm	21,07	1	SB7805SM-20
21 mm	22,60	1	SB7805SM-21
22 mm	22,78	1	SB7805SM-22
23 mm	23,47	1	SB7805SM-23
24 mm	23,47	1	SB7805SM-24
25 mm	23,47	1	SB7805SM-25
26 mm	23,47	1	SB7805SM-26
27 mm	25,89	1	SB7805SM-27
28 mm	24,17	1	SB7805SM-28
29 mm	25,82	1	SB7805SM-29
30 mm	27,66	1	SB7805SM-30
32 mm	29,89	1	SB7805SM-32
34 mm	32,67	1	SB7805SM-34

SB: Embalaje en blíster con información del producto

Vaso 1/2" cuadrado, serie larga



7805SZ

Ø	€	Icons	Part Name
1.3/16 in	22,99	1	7805SZ-1.3/16
1.1/4 in	24,39	1	7805SZ-1.1/4
1.5/16 in	26,33	1	7805SZ-1.5/16
1.3/8 in	28,04	1	7805SZ-1.3/8
1.7/16 in	44,78	1	7805SZ-1.7/16
1.1/2 in	44,78	1	7805SZ-1.1/2



Vaso de 1/2" bihex, mm



7800DM

Ø	€	SB	Icon
8 mm	6,40	10	7800DM-8
9 mm	6,40	10	7800DM-9
10 mm	6,40	10	7800DM-10
11 mm	6,52	10	7800DM-11
12 mm	6,90	10	7800DM-12
13 mm	7,20	10	7800DM-13
14 mm	7,58	10	7800DM-14
15 mm	7,85	10	7800DM-15
16 mm	8,00	10	7800DM-16
17 mm	8,32	10	7800DM-17
18 mm	8,32	10	7800DM-18
19 mm	8,64	10	7800DM-19
20 mm	8,88	10	7800DM-20
21 mm	9,12	10	7800DM-21
22 mm	9,45	10	7800DM-22
23 mm	9,93	10	7800DM-23
24 mm	10,65	10	7800DM-24
25 mm	10,82	10	7800DM-25
26 mm	11,04	10	7800DM-26
27 mm	11,34	10	7800DM-27
28 mm	12,17	10	7800DM-28
29 mm	12,49	10	7800DM-29
30 mm	12,64	10	7800DM-30
31 mm	12,85	10	7800DM-31
32 mm	13,14	10	7800DM-32
33 mm	11,57	10	7800DM-33
34 mm	16,49	10	7800DM-34
36 mm	24,89	10	7800DM-36
8 mm	7,58	1	SB7800DM-8
9 mm	7,58	1	SB7800DM-9
10 mm	7,58	1	SB7800DM-10
11 mm	7,69	1	SB7800DM-11
12 mm	8,06	1	SB7800DM-12
13 mm	8,36	1	SB7800DM-13
14 mm	8,73	1	SB7800DM-14
15 mm	9,01	1	SB7800DM-15
16 mm	9,18	1	SB7800DM-16
17 mm	9,50	1	SB7800DM-17
18 mm	9,50	1	SB7800DM-18
19 mm	9,82	1	SB7800DM-19
21 mm	10,05	1	SB7800DM-20
21 mm	10,29	1	SB7800DM-21
22 mm	10,60	1	SB7800DM-22
23 mm	11,10	1	SB7800DM-23
24 mm	11,81	1	SB7800DM-24
25 mm	11,98	1	SB7800DM-25
26 mm	12,20	1	SB7800DM-26
27 mm	12,53	1	SB7800DM-27
28 mm	13,35	1	SB7800DM-28
29 mm	13,66	1	SB7800DM-29
30 mm	13,81	1	SB7800DM-30
31 mm	14,17	1	SB7800DM-31
32 mm	14,32	1	SB7800DM-32
33 mm	12,22	1	SB7800DM-33
34 mm	17,16	1	SB7800DM-34
36 mm	26,12	1	SB7800DM-36

SB: Embalaje en blíster con información del producto

Vasos de 1/2" bihexagonal, pulgadas



7800DZ

Ø	€	SB	Icon
5/16 in	8,09	10	7800DZ-5/16
11/32 in	8,09	10	7800DZ-11/32
3/8 in	6,55	10	7800DZ-3/8
13/32 in	8,09	10	7800DZ-13/32
7/16 in	6,73	10	7800DZ-7/16
1/2 in	7,39	10	7800DZ-1/2
9/16 in	7,87	10	7800DZ-9/16
19/32 in	8,09	10	7800DZ-19/32
5/8 in	8,32	10	7800DZ-5/8
11/16 in	8,55	10	7800DZ-11/16
3/4 in	8,97	10	7800DZ-3/4
25/32 in	9,12	10	7800DZ-25/32
13/16 in	9,45	10	7800DZ-13/16
7/8 in	9,77	10	7800DZ-7/8
15/16 in	10,96	10	7800DZ-15/16
1 in	11,04	10	7800DZ-1
1 1/16 in	11,68	10	7800DZ-1.1/16
1 1/8 in	12,42	10	7800DZ-1.1/8
1 3/16 in	13,13	10	7800DZ-1.3/16
1 1/4 in	13,29	10	7800DZ-1.1/4
1.5/16 in	11,65	10	7800DZ-1.5/16
1.3/8 in	11,65	10	7800DZ-1.3/8
1.7/16 in	12,12	1	7800DZ-1.7/16
1.1/2 in	11,22	10	7800DZ-1.1/2
3/8 in	7,25	1	SB7800DZ-3/8
7/16 in	7,40	1	SB7800DZ-7/16
1/2 in	8,07	1	SB7800DZ-1/2
9/16 in	8,55	1	SB7800DZ-9/16
19/32 in	8,78	1	SB7800DZ-19/32
5/8 in	9,01	1	SB7800DZ-5/8
11/16 in	9,25	1	SB7800DZ-11/16
3/4 in	9,65	1	SB7800DZ-3/4
25/32 in	9,81	1	SB7800DZ-25/32
13/16 in	10,13	1	SB7800DZ-13/16
7/8 in	10,44	1	SB7800DZ-7/8
15/16 in	11,65	1	SB7800DZ-15/16
1 in	11,72	1	SB7800DZ-1
1.1/16 in	12,37	1	SB7800DZ-1.1/16
1.1/8 in	13,08	1	SB7800DZ-1.1/8
1.3/16 in	13,82	1	SB7800DZ-1.3/16
1.1/4 in	13,96	1	SB7800DZ-1.1/4
1 5/16 in	13,74	1	SB7800DZ-1.5/16

SB: Embalaje en blíster con información del producto

Vasos largos 1/2" hexagonales pulgadas



7800SZ

Ø	€	SB	Icon
3/8 in	4,41	10	7800SZ-3/8
7/16 in	4,58	10	7800SZ-7/16
1/2 in	7,39	10	7800SZ-1/2
9/16 in	4,64	10	7800SZ-9/16
11/16 in	5,41	10	7800SZ-11/16
3/4 in	5,61	10	7800SZ-3/4
13/16 in	5,71	10	7800SZ-13/16
7/8 in	6,05	10	7800SZ-7/8
1 3/16 in	7,79	10	7800SZ-1.3/16

SB: presentación clip colgable

Vaso de 1/2" bihexagonal, mm



7805DM

Ø	€	SB	Icon
10 mm	17,14	10	7805DM-10
12 mm	17,14	10	7805DM-12
13 mm	17,14	10	7805DM-13
14 mm	17,92	10	7805DM-14
15 mm	18,83	10	7805DM-15
16 mm	19,37	10	7805DM-16
17 mm	19,37	10	7805DM-17
18 mm	19,37	10	7805DM-18
19 mm	19,37	10	7805DM-19
21 mm	21,52	10	7805DM-21
22 mm	21,73	10	7805DM-22
23 mm	21,80	10	7805DM-23
24 mm	22,38	10	7805DM-24
26 mm	22,38	10	7805DM-26
27 mm	24,80	10	7805DM-27
30 mm	26,52	10	7805DM-30
32 mm	27,18	10	7805DM-32
34 mm	27,18	10	7805DM-34
10 mm	17,84	1	SB7805DM-10
12 mm	17,84	1	SB7805DM-12
13 mm	17,84	1	SB7805DM-13
14 mm	18,59	1	SB7805DM-14
15 mm	19,51	1	SB7805DM-15
16 mm	20,06	1	SB7805DM-16
17 mm	20,06	1	SB7805DM-17
18 mm	20,06	1	SB7805DM-18
19 mm	20,06	1	SB7805DM-19
21 mm	22,20	1	SB7805DM-21
22 mm	22,39	1	SB7805DM-22
23 mm	22,44	1	SB7805DM-23

Ø	€		
24 mm	23,06	1	SB7805DM-24
26 mm	23,06	1	SB7805DM-26
27 mm	25,49	1	SB7805DM-27
30 mm	27,22	1	SB7805DM-30
32 mm	27,83	1	SB7805DM-32
34 mm	21,68	1	SB7805DM-34

SB: Embalaje en blister con información del producto

Vaso 1/2", serie larga



7805DZ

Ø	€		
5/8 in	16,77	10	7805DZ-5/8
11/16 in	16,77	10	7805DZ-11/16
3/4 in	16,77	10	7805DZ-3/4
13/16 in	18,65	10	7805DZ-13/16
7/8 in	18,82	10	7805DZ-7/8
15/16 in	19,41	10	7805DZ-15/16
1 in	20,34	10	7805DZ-1
1.1/16 in	21,50	10	7805DZ-1.1/16
1.1/8 in	24,11	10	7805DZ-1.1/8
1.13/16 in	22,99	10	7805DZ-1.3/16
1.1/4 in	24,39	10	7805DZ-1.1/4
1.5/16 in	26,33	10	7805DZ-1.5/16
1.3/8 in	28,04	10	7805DZ-1.3/8
1.7/16 in	44,78	10	7805DZ-1.7/16
1.1/2 in	44,78	10	7805DZ-1.1/2

Vaso TORX® hembra, cuadrado 1/2"



7800TORX-E

Ø	€		
E8	9,25	1	7800TORX-E8
E10	10,40	1	7800TORX-E10
E11	10,40	1	7800TORX-E11
E12	10,40	1	7800TORX-E12
E14	10,40	1	7800TORX-E14
E16	10,56	1	7800TORX-E16
E18	10,56	1	7800TORX-E18
E20	11,13	1	7800TORX-E20
E24	12,23	1	7800TORX-E24
E8	9,93	1	SB7800TORX-E8
E10	11,10	1	SB7800TORX-E10
E11	11,10	1	SB7800TORX-E11
E12	11,10	1	SB7800TORX-E12

Ø	€		
E14	11,10	1	SB7800TORX-E14
E16	11,24	1	SB7800TORX-E16
E18	11,24	1	SB7800TORX-E18
E20	11,81	1	SB7800TORX-E20
E24	12,92	1	SB7800TORX-E24

SB: Embalaje en blister con información del producto

Berbiquí 1/2", con mango de acero giratorio



8152-1/2

L	€		
425 mm	47,45	1	8152-1/2

Mango articulado de 1/2"



8157

L	€		
257 mm	94,59	1	8157-10
390 mm	55,01	1	8157-15
600 mm	86,50	1	8157-24
900 mm	132,68	10	8157-36
257 mm	95,73	1	SB8157-10
390 mm	56,16	1	SB8157-15
600 mm	96,78	1	SB8157-24
900 mm	133,82	1	SB8157-36

SB: Clip para colgar

Mango articulado de 1/2"



8158

L	€		
270 mm	30,39	1	8158-10
390 mm	32,45	1	8158-15
270 mm	34,69	1	SB8158-10
390 mm	44,22	1	SB8158-15

SB: Clip para colgar

Mango acodado 1/2"



8167-1/2

L	€		
180 mm	15,66	10	8167

Mango corredizo en T, 1/2"



8154

L	€		
280 mm	24,01	1	SB8154-11
280 mm	19,02	10	8154-11

SB: Clip para colgar

Adaptador cabeza corrediza 3/8" a 1/2"



7772H

Ø	Ø	€	
3/8"	1/2"	3,11	10 7772H

Alargadera de 1/2"



8160

L	€		
75 mm	12,50	10	8160-3
125 mm	14,74	10	8160-5
250 mm	18,57	10	8160-10
75 mm	16,42	1	SB8160-3
125 mm	11,07	1	SB8160-5
250 mm	19,85	1	SB8160-10

SB: Clip para colgar



Alargadera angular 1/2"



8159-W - 8162-W

L	€		
75 mm	16,16	10	8160W-3
125 mm	16,96	10	8160W-5
250 mm	21,29	10	8160W-10

Articulación universal de 1/2",
funcionamiento fluido



8168

L	€		
62 mm	38,32	1	8168

Aumentador de entrada 1/2" a salida 3/4"



8172

1/2"	3/4"	€		
1/2"	3/4"	20,18	10	8172
1/2"	3/4"	23,33	1	SB8172

SB: Clip para colgar

Alargadera con bloqueo 1/2"



8160-B

L	€		
125 mm	27,68	1	8160-B

Reductor de entrada 1/2" a salida 3/8"



8171

1/2"	3/8"	€		
1/2"	3/8"	16,97	10	8171
1/2"	3/8"	19,85	1	SB8171

Este producto no está garantizado contra la rotura del cuadrado macho.
SB: Clip para colgar

Amplificador plano de 1/2" a 3/4"



8967

1/2	3/4	€		
1/2	3/4	32,65	1	8967

Articulación universal de 1/2"



8166

L	€		
72 mm	32,96	10	8166
72 mm	35,75	1	SB8166

SB: Clip para colgar

Llave combinada escalonada



8195-key

g	€		
140 g	21,39	50	8195-KEY

Para usar con 8195-R

Adaptador de 1/2" para puntas 5/16"



7106S

5/16 in	€		
5/16 in	9,74	10	8174A

Adaptador 1/2" para puntas 5/16"



7809HL

	€		
5/16 in	12,74	1	7809HL

Kit de repuestos para mango mango articulado 1/2" 8169-1/2



SP120

	€		
75 g	26,80	1	SP120

Kit de repuestos para mango mango articulado 1/2" 8170-1/2



SP120XL

	€		
55 g	12,76	1	SP120XL

Regletas y clips 1/2"



C1/2

	€		
19 mm	0,38	25	CLIPS-1/2

Vaso con punta recta cuadrado 1/2"



7809F

		€		
0.8 mm	8 mm	14,31	5	7809F-8
1 mm	10 mm	14,59	5	7809F-10

Vaso con punta Phillips cuadrado 1/2"



7809PH

	€		
2	12,46	1	7809PH-2
3	12,85	1	7809PH-3
4	12,85	1	7809PH-4

Vaso con punta Pozidriv cuadrado 1/2"



7809PZ

	€		
2	12,23	1	7809PZ-2
3	12,91	1	7809PZ-3

Vaso con punta TORX® cuadrado 1/2"



7809TORX

	€		
T20	14,73	1	7809TORX-T20
T25	14,73	1	7809TORX-T25
T27	14,73	1	7809TORX-T27
T30	14,73	1	7809TORX-T30
T40	17,19	1	7809TORX-T40
T45	17,19	1	7809TORX-T45
T50	17,19	1	7809TORX-T50
T55	21,52	1	7809TORX-T55
T60	21,52	1	7809TORX-T60
T70	21,53	10	7809TORX-T70
T20	15,90	1	SB7809TORX-T20
T25	15,90	1	SB7809TORX-T25
T27	15,90	1	SB7809TORX-T27
T30	15,90	1	SB7809TORX-T30
T40	18,39	1	SB7809TORX-T40
T45	18,39	1	SB7809TORX-T45
T50	18,39	1	SB7809TORX-T50
T55	22,74	1	SB7809TORX-T55
T60	22,74	1	SB7809TORX-T60

SB: Embalaje en blister con información del producto



Vasos largos con punta TORX®, cuadrado 1/2"



7809TORX L

		€		
T20	80 mm	20,09	1	7809TORX-T20-120
T25	80 mm	20,09	1	7809TORX-T25-120
T27	80 mm	20,09	1	7809TORX-T27-120
T30	80 mm	20,09	1	7809TORX-T30-120
T40	82 mm	21,97	1	7809TORX-T40-120
T45	80 mm	21,97	1	7809TORX-T45-120
T50	62 mm	21,97	1	7809TORX-T50-100
T55	80 mm	25,44	1	7809TORX-T55-120
T60	80 mm	25,44	1	7809TORX-T60-120
T70	102 mm	31,08	5	7809TORX-T70-140

Juego de 9 vasos con punta TORX® 1/2" en rail



7809TO

	€		
9	151,67	1	7809TO

7809TORX-T27, 7809TORX-T20, 7809TORX-T25, 7809TORX-T30, 7809TORX-T50, 7809TORX-T40, 7809TORX-T45, 7809TORX-T60, 7809TORX-T55

Juego de vasos con punta y cuadradillo de 1/2" para tornillo de cabeza TORX® (9 piezas)



7800TORX/9

	€		
800 g	93,01	1	7800TORX/9

7800TORX-E8, 7800TORX-E10, 7800TORX-E11, 7800TORX-E12, 7800TORX-E14, 7800TORX-E16, 7800TORX-E18, 7800TORX-E20, 7800TORX-E24

Vaso con punta hexagonal cuadrado 1/2", mm



7809M

	€		
4 mm	12,98	10	7809M-4
5 mm	12,98	1	7809M-5
6 mm	12,98	1	7809M-6
7 mm	12,98	1	7809M-7
8 mm	14,08	1	7809M-8
9 mm	14,08	1	7809M-9
10 mm	14,08	1	7809M-10
12 mm	14,39	1	7809M-12
14 mm	14,42	1	7809M-14
17 mm	15,13	1	7809M-17
19 mm	15,55	1	7809M-19
4 mm	14,17	1	SB7809M-4
5 mm	14,17	1	SB7809M-5
6 mm	14,17	1	SB7809M-6
7 mm	14,17	1	SB7809M-7
8 mm	15,25	1	SB7809M-8
9 mm	15,25	1	SB7809M-9
10 mm	15,25	1	SB7809M-10
12 mm	15,58	1	SB7809M-12
14 mm	15,97	1	SB7809M-14
17 mm	16,48	1	SB7809M-17
19 mm	16,73	1	SB7809M-19

SB: Embalaje en blister con información del producto

Vasos largos con punta hexagonal, cuadrado 1/2"



7809M L

	€		
4 mm	80 mm	11,60	1 7809M-4-120
5 mm	80 mm	11,60	1 7809M-5-120
5 mm	143 mm	21,46	1 7809M-5-180
6 mm	80 mm	11,60	1 7809M-6-120

	€		
7 mm	63 mm	17,07	1 7809M-7-100
8 mm	83 mm	19,64	1 7809M-8-120
10 mm	80 mm	11,60	1 7809M-10-120
12 mm	80 mm	11,60	1 7809M-12-120
14 mm	80 mm	11,60	10 7809M-14-120
17 mm	80 mm	11,60	10 7809M-17-120
19 mm	80 mm	11,60	8 7809M-19-120
5 mm	140 mm	22,64	1 SB7809M-5-180
7 mm	63 mm	18,24	1 SB7809M-7-100
8 mm	81 mm	20,82	1 SB7809M-8-120

Juego de 8 vasos con punta hexagonal 1/2" en rail, mm



7808HM

	€		
8	110,36	1	7808HM

7809M-4, 7809M-6, 7809M-8, 7809M-7, 7809M-5, 7809M-10, 7809M-12, 7809M-14

Vaso con punta hexagonal cuadrado 1/2", pulgadas



7809Z

	€		
1/4 in	12,75	1	7809Z-3/16
5/16 in	12,75	1	7809Z-1/4
3/8 in	12,75	1	7809Z-5/16
7/16 in	13,11	1	7809Z-3/8
1/2 in	13,84	1	7809Z-7/16
17/32 in	14,31	1	7809Z-1/2
9/16 in	14,20	1	7809Z-17/32
19/32 in	14,56	1	7809Z-9/16
5/8 in	14,56	1	7809Z-19/32
			7809Z-5/8

Vaso con punta XZN cuadrado 1/2"



7809XZN



	€		
6	18,08	1	7809XZN-6
8	18,20	1	7809XZN-8
8	19,91	1	7809XZN-8-100
10	19,10	1	7809XZN-10
10	23,61	1	7809XZN-10-100
12	23,61	1	7809XZN-12
12	25,79	1	7809XZN-12-100
14	25,23	1	7809XZN-14
14	29,51	1	7809XZN-14-100
16	27,65	1	7809XZN-16
18	29,46	1	7809XZN-18

Llave de carraca reversible, 1/2"



8150RN-1/2

L		€	
267 mm	72	62,68	1 8150RN-1/2
267 mm	72	63,43	1 SB8150RN-1/2

SB: Clip para colgar

Carraca reversible 1/2", cuadrado pasante



8195-R

L		€	
260 mm	60	52,93	1 8195-R

Llave de carraca 1/2" cabeza delgada 72 dientes



8150SL

L		€	
264 mm	72	66,06	1 8150SL

Llave de carraca reversible de 1/2"



SBS81

L		€	
250 mm	60	41,04	5 SBS81

Set carraca de válvula de radiador



8195-SET

	€	
350 x 20 x 80 mm	64,47	5 8195-SET

- 8195-R
- 8195-SQ
- 8195-KEY

Llave de carraca reversible 1/2"



8150-1/2

L		€	
269 mm	80	64,90	1 8150-1/2
269 mm	80	65,66	1 SB8150-1/2

SB: Clip para colgar

Carraca 1/2" con cabeza giratoria



8120-1/2

L		€	
266 mm	72	60,28	12 8120-1/2

Llave de carraca articulada de 1/2" reversible



8110H-1/2

L		€	
440 mm	32	99,97	1 8110H-1/2



Conductor para la llave de carraca 8193-1/2



8194-1/2

	€		
32 mm	6,23	1	8194-1/2

Conductor para carraca 8195-R



8195-SQ

		€		
37.5 mm	40 g	5,68	25	8195-SQ

Adaptador para llave de carraca de 1/2"



8151-1/2

	€		
71 mm	85,37	1	8151-1/2

Kit de reparación para carraca cabeza delgada 1/2" 8150SL



8150SL-SPARE

		€		
12	8150SL	20,55	1	8150SL-SPARE

Kit de reparación para carraca 1/2 8150-1/2



8150-1/2-SPARE

		€		
11	8150-1/2	30,58	1	8150-1/2-SPARE

Kit de reparación para carraca 1/2 8150RN-1/2



8150RN-1/2-SPARE

		€		
6	8150RN-1/2	18,94	1	8150RN-1/2-SPARE

3/4"

Vasos de 3/4" hexagonales, mm



8900SM

	€		
19 mm	18,03	1	8900SM-19
22 mm	18,03	1	8900SM-22
23 mm	18,03	1	8900SM-23
24 mm	19,35	5	8900SM-24
26 mm	19,61	5	8900SM-26
27 mm	19,99	5	8900SM-27
28 mm	19,99	1	8900SM-28
29 mm	22,40	1	8900SM-29
30 mm	22,40	5	8900SM-30
32 mm	23,36	5	8900SM-32
33 mm	23,36	1	8900SM-33
34 mm	24,85	1	8900SM-34
35 mm	24,85	1	8900SM-35
36 mm	27,02	5	8900SM-36
38 mm	28,75	1	8900SM-38
41 mm	31,68	5	8900SM-41
42 mm	31,68	1	8900SM-42
46 mm	37,38	1	8900SM-46
50 mm	42,60	1	8900SM-50
55 mm	51,25	1	8900SM-55
60 mm	56,98	1	8900SM-60

Vasos estándar, cuadrado 3/4"



8900SZ

	€		
3/4 in	15,87	1	8900SZ-3/4
13/16 in	21,90	1	8900SZ-13/16
1 in	24,01	1	8900SZ-1
1.7/16 in	30,15	1	8900SZ-1.7/16
1.9/16 in	31,41	1	8900SZ-1.9/16
1.7/8 in	41,76	1	8900SZ-1.7/8
2 in	45,50	1	8900SZ-2

Vaso longitud estándar, cuadrado 3/4"



8900DM

€	Icon	Icon
19 mm	17,79	1 8900DM-19
21 mm	15,36	5 8900DM-21
22 mm	18,31	1 8900DM-22
23 mm	17,34	1 8900DM-23
24 mm	19,61	1 8900DM-24
25 mm	19,05	1 8900DM-25
26 mm	17,19	1 8900DM-26
27 mm	19,99	1 8900DM-27
28 mm	20,97	1 8900DM-28
29 mm	19,72	1 8900DM-29
30 mm	22,40	5 8900DM-30
32 mm	23,36	1 8900DM-32
33 mm	22,99	1 8900DM-33
34 mm	24,85	1 8900DM-34
35 mm	22,99	1 8900DM-35
36 mm	27,02	1 8900DM-36
37 mm	27,70	1 8900DM-37
38 mm	31,72	1 8900DM-38
40 mm	34,12	1 8900DM-40
41 mm	31,68	5 8900DM-41
42 mm	34,11	1 8900DM-42
46 mm	37,38	1 8900DM-46
47 mm	35,06	1 8900DM-47
50 mm	42,59	5 8900DM-50
52 mm	44,66	1 8900DM-52
40 mm	44,66	3 8900DM-54
55 mm	51,26	1 8900DM-55
56 mm	52,29	1 8900DM-56
60 mm	56,98	5 8900DM-60

Vaso longitud estándar, cuadrado 3/4"



8900DZ

€	Icon	Icon
3/4 in	12,52	1 8900DZ-3/4
13/16 in	16,33	1 8900DZ-13/16
7/8 in	19,83	1 8900DZ-7/8
15/16 in	19,58	1 8900DZ-15/16
31/32 in	22,56	1 8900DZ-31/32
1 in	19,74	1 8900DZ-1
1 1/16 in	20,39	1 8900DZ-1.1/16
1 1/8 in	21,38	1 8900DZ-1.1/8
1 1/4 in	23,63	1 8900DZ-1.1/4
1 5/16 in	25,63	5 8900DZ-1.5/16
1 3/8 in	25,63	1 8900DZ-1.3/8
1 1/2 in	28,97	1 8900DZ-1.1/2
1.9/16 in	33,47	1 8900DZ-1.9/16
1 5/8 in	32,63	1 8900DZ-1.5/8
1.11/16 in	33,86	1 8900DZ-1.11/16
1 3/4 in	37,86	1 8900DZ-1.3/4
1 13/16 in	37,86	1 8900DZ-1.13/16

€	Icon	Icon
1 7/8 in	43,12	1 8900DZ-1.7/8
2 in	43,12	1 8900DZ-2
2.1/16 in	43,01	1 8900DZ-2.1/16
2.1/8 in	43,02	1 8900DZ-2.1/8
2.3/16 in	48,95	1 8900DZ-2.3/16
2.1/4 in	44,90	1 8900DZ-2.1/4
2.3/8 in	54,09	1 8900DZ-2.3/8

Extensión telescópica 3/4"



8953E-32

€	Icon	Icon
495 to 810 mm	77,97	1 8953E-32

Mango universal para 8952N/A



8952N/B

€	Icon	Icon
450 mm	23,43	1 8952N/B

Mango corredizo en T de 3/4"



8954

€	Icon	Icon
390 mm	69,22	1 8954-15

Mango universal 8953 y cabeza 8954A

Cabeza corrediza de 3/4"



8954A

€	Icon	Icon
62 mm	36,66	1 8954A

Mangos articulados con cabeza flexible de 3/4" de cuadradillo



8957-19

€	Icon	Icon
480 mm	94,25	1 8957-19

Cabeza para mango articulado de 3/4"



8958A

€	Icon	Icon
125 mm	92,95	1 8958A

Cabezas flexibles con cuadradillo de 3/4" para barra rompedora 8957



8957A

€	Icon	Icon
140 mm	76,50	1 8957A

Mango acodado 3/4"



8963

€	Icon	Icon
415 mm	39,56	1 8963



Alargadera de 3/4"



8961/8962

← L →	€		
200 mm	39,03	1	8960-8
400 mm	48,62	12	8960-16

Aumentador de entrada 3/4" a salida 1"



9564

		€		
3/4"	1"	29,82	1	8972

Cabeza de carraca de 3/4", reversible



8950N/A

← L →		€		
170 mm	72	113,30	1	8950RN/A

Con el mango 8953 forma la carraca 8950N

Articulación universal de 3/4"



8966

← L →	€		
120 mm	94,65	1	8966

Llave de carraca de 3/4" reversible



8950N

← L →		€		
525 mm	72	129,06	1	8950RN

Compuesto por 8950N/A + 8953

Accesorios para carraca de 3/4"



8955N/A

← L →		€		
152 mm	24	92,44	1	8955N/A

Reductor de entrada 3/4" a salida 1/2"



8965

		€		
3/4"	1/2"	26,68	1	8971

Este producto no está garantizado contra la rotura del cuadrado macho

Carracas 3/4"



8955N

← L →		€		
525 mm	24	117,09	1	8955N

Mango universal 3/4"



8955N/B

	← L →	€		
1160 g	390 mm	32,96	5	8955N/B

Cabeza de carraca 3/4" cuadrado macho y hembra



8951

	€		
95.5 mm	346,92	1	8951

Compatible con mango corredizo

Kit de reparación para carracas de 3/4" 8950N, 8950N/A



8950NA-SO/2

		€		
8	8950N, 8950N/A	99,70	1	8950NA-SO/2

Repuesto para carracas de 3/4"



8955N-SPARE

		€		
11	8955N, 8955N/A	49,29	1	8955N-SPARE

1"

Vaso Hexagonal 1", mm



9500SM

	€		
41 mm	46,68	1	9500SM-41
46 mm	54,44	1	9500SM-46
50 mm	60,22	1	9500SM-50
54 mm	64,18	1	9500SM-54
55 mm	68,55	1	9500SM-55
58 mm	74,92	1	9500SM-58
60 mm	83,73	1	9500SM-60
63 mm	93,85	1	9500SM-63
65 mm	100,08	1	9500SM-65
67 mm	106,59	1	9500SM-67
70 mm	112,44	1	9500SM-70
71 mm	118,34	1	9500SM-71
75 mm	125,85	1	9500SM-75
77 mm	133,85	1	9500SM-77
80 mm	143,32	1	9500SM-80
82 mm	152,81	1	9500SM-82

Vaso estándar, 1"



9500DZ

	€		
1.5/8 in	34,42	1	9500DZ-1.5/8
1.13/16 in	40,11	1	9500DZ-1.13/16
1.7/8 in	40,11	1	9500DZ-1.7/8
2 in	52,67	1	9500DZ-2
2.1/8 in	52,67	1	9500DZ-2.1/8
2.3/16 in	52,67	1	9500DZ-2.3/16
2.1/4 in	52,67	1	9500DZ-2.1/4
2.3/8 in	60,61	1	9500DZ-2.3/8
2.1/2 in	60,61	1	9500DZ-2.1/2
2.9/16 in	60,61	1	9500DZ-2.9/16
2.5/8 in	70,22	1	9500DZ-2.5/8
2.3/4 in	68,91	1	9500DZ-2.3/4
2.15/16 in	82,35	1	9500DZ-2.15/16
3 in	94,61	1	9500DZ-3
3.1/8 in	94,61	1	9500DZ-3.1/8

Articulación universal 1"



9566A

	€		
167 mm	88,59	1	9566A

Mango corredizo en T 1"



9555

	€		
508 mm	100,07	1	9555

Cabeza de mango corredizo 9555AB y mango universal 9552AB

Cabeza corrediza, 1"



9555AB

	€		
78x78x78 mm	46,75	1	9555AB

Alargadera 1"



9560AB/9563AB

	€		
200 mm	75,71	1	9560AB
440 mm	96,99	1	9563AB



Reductor de 1" a 3/4"



9565AB

Icon	€	Icon	Icon
3/4"	50,59	1	9565AB

Este producto no está garantizado contra la rotura del cuadrado macho

Carraca 1"



9550N

Icon	€	Icon	Icon
640 mm	263,03	1	9550N

Mango universal 1"



9550N/B

Icon	€	Icon	Icon
1960 g	53,93	1	9550N/B

Accesorios para carraca 1"



9550N/A

Icon	€	Icon	Icon
195 mm	215,72	1	9550N/A

Repuesto para carracas de 1"



9550N-SPARE

Icon	€	Icon	Icon
2	73,95	1	9550N-SPARE

CAJAS VACÍAS PARA JUEGOS DE VASOS

Cajas vacías para juegos de vasos



-CASE

Icon	g	€	Icon	Icon
110 x 375 x 430 mm	2200 g	62,10	1	S103-CASE
100 x 215 x 370 mm	1120 g	44,82	1	S240AF-CASE
70 x 160 x 280 mm	500 g	31,01	1	S330-CASE
110 x 320 x 375 mm	1620 g	50,57	1	S400-CASE
110 x 320 x 375 mm	1620 g	50,58	1	S410-CASE
100 x 215 x 375 mm	1120 g	44,83	1	S460-CASE
100 x 215 x 375 mm	1120 g	44,50	1	S560-CASE

Icon	g	€	Icon	Icon
110 x 375 x 430 mm	2200 g	60,67	1	S81MIX-CASE
110 x 375 x 430 mm	2200 g	60,01	1	S108-CASE
110 x 375 x 430 mm	2200 g	51,47	1	SLX17-CASE
100 x 215 x 375 mm	1120 g	43,44	1	S330L-CASE

Caja vacía de plástico inyectado



4750IB

Icon	€	Icon	Icon
35 x 80 x 100 mm	12,95	1	SPAR-CASE-A7
35 x 85 x 160 mm	13,62	1	SPAR-CASE-A6
49 x 152 x 280 mm	19,31	1	SPAR-CASE-A4

LLAVES DE CARRACA PARA ESTRUCTURAS

Llave a carraca de doble boca para estructuras



SC2RM

Icon	€	Icon	Icon
13-17 mm	37,14	10	SC2RM-13-17
15-17 mm	37,74	10	SC2RM-15-17
19-22 mm	38,93	10	SC2RM-19-22
27-30 mm	70,08	1	SC2RM-27-30



Herramientas dinamométricas

LLAVES DINAMOMÉTRICAS DIGITALES

Llave dinamométrica y de ángulo delgada Bluetooth® con memoria y cabeza rectangular intercambiable

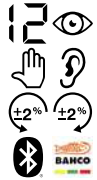

TAWMB MICRO

mm	Nm	Nm	€		
9x12 mm	1.5-30 N·m	0.01 N·m	1.706,65	1	TAWMB930M
9x12 mm	6.8-135 N·m	0.1 N·m	1.818,76	1	TAWMB9135M

PRECISIÓN: 20% a 100% de escala completa

Llave dinamométrica y de ángulo Bluetooth® con memoria y cabeza rectangular intercambiable



TAWMB14_24

mm	Nm	Nm	€		
14x18 mm	17-340 N·m	1 N·m	1.930,88	1	TAWMB14340
24x32 mm	32.5-650 N·m	1 N·m	2.229,85	1	TAWMB24650
24x32 mm	40-800 N·m	1 N·m	2.478,25	1	TAWMB24800

PRECISIÓN: 20% a 100% de escala completa

Llave dinamométrica electrónica de par y grados, con memoria/USB y cabeza de carraca fija



TAWM MICRO

mm	Nm	Nm	€		
1/4 in	0.6-12 N·m	0.01 N·m	1.052,21	1	TAWM1412M
1/4 in	1.5-30 N·m	0.01 N·m	1.064,97	1	TAWM1430M
3/8 in	6.8-135 N·m	0.1 N·m	1.264,41	1	TAWM38135M

PRECISIÓN: 20% a 100% de escala completa

Llave dinamométrica electrónica de par y grados, con memoria/USB y cabeza intercambiable rectangular



TAWM9 MICRO

mm	Nm	Nm	€		
9x12 mm	0.6-12 N·m	0.01 N·m	1.027,38	1	TAWM912M
9x12 mm	1.5-30 N·m	0.01 N·m	1.084,84	1	TAWM930M
9x12 mm	6.8-135 N·m	0.1 N·m	1.239,50	1	TAWM9135M

Precisión: 20% a 100% de escala completa

Llave dinamométrica electrónica de par y grados, con memoria/USB y cabeza de carraca fija



TAWM

mm	Nm	Nm	€		
3/8 in	7-135 N·m	1 N·m	1.222,08	1	TAWM38135
1/2 in	17-340 N·m	1 N·m	1.201,68	1	TAWM12340
3/4 in	40-800 N·m	1 N·m	1.729,07	1	TAWM34800

Precisión: 20% a 100% de escala completa

Llave dinamométrica electrónica de par y grados, con memoria/USB y cabeza intercambiable rectangular



TAWM9_14_24

mm	Nm	Nm	€		
9x12 mm	7-135 N·m	1 N·m	1.177,76	1	TAWM9135
14x18 mm	17-340 N·m	1 N·m	1.265,46	1	TAWM14340
24x32 mm	40-800 N·m	1 N·m	1.866,87	1	TAWM24800

Precisión: 20% a 100% de escala completa

Llave dinamométrica electrónica de par y grados y cabeza de carraca fija



TAW MICRO

	mm	Nm	Nm	€		
1/4 in	0.6-12 N·m	0.01 N·m	916,15	1	TAW1412M	
1/4 in	1.5-30 N·m	0.01 N·m	916,15	1	TAW1430M	
3/8 in	6.8-135 N·m	0.1 N·m	909,38	1	TAW38135M	

Precisión: 20% a 100% de escala completa

Llave dinamométrica electrónica de par y grados y cabeza intercambiable rectangular



TAW9 MICRO

	mm	Nm	Nm	€		
9x12 mm	0.6-12 N·m	0.01 N·m	809,72	1	TAW912M	
9x12 mm	1.5-30 N·m	0.01 N·m	830,65	1	TAW930M	
9x12 mm	6.8-135 N·m	0.1 N·m	884,46	1	TAW9135M	

Precisión: 20% a 100% de escala completa

Llave dinamométrica electrónica de par y grados y cabeza de carraca fija



TAW

	mm	Nm	Nm	€		
3/8 in	7-135 N·m	1 N·m	707,66	1	TAW38135	
1/2 in	17-340 N·m	1 N·m	774,42	1	TAW12340	
3/4 in	40-800 N·m	1 N·m	1.375,26	1	TAW34800	

Precisión: 20% a 100% de escala completa

Llave dinamométrica electrónica de par y grados y cabeza intercambiable rectangular



TAW9 14 24

	mm	Nm	Nm	€		
9x12 mm	7-135 N·m	1 N·m	939,70	1	TAW9135	
14x18 mm	17-340 N·m	1 N·m	1.039,93	1	TAW14340	
24x32 mm	40-800 N·m	1 N·m	1.233,30	1	TAW24800	

Precisión: 20% a 100% de escala completa

Llave dinamométrica electrónica con cabeza intercambiable con conexión rectangular



IZO-D

	mm	Nm	Nm	€		
1/4 in	3-30 N·m	0.1 N·m	745,95	1	IZO-D-30	
3/8 in	13.5-135 N·m	1 N·m	745,95	1	IZO-D-135	
1/2 in	20-200 N·m	1 N·m	817,83	1	IZO-D-200	
1/2 in	34-340 N·m	1 N·m	942,40	1	IZO-D-340	

IZOD-30: 1/4"-9x12; D135: 3/8" - 9x12 IZO D-200: 1/2" 14x18; IZOD-340: 1/2" 14x18

Llave dinamométrica electrónica con cabeza fija de carraca



IZO-DR

	mm	Nm	Nm	€		
3/4 in	81-810 N·m	1 N·m	2.239,72	1	IZO-DR-810	

Cabeza de carraca 3/4"



LLAVES DINAMOMÉTRICAS MECÁNICAS

Llave dinamométrica mecánica de disparo ajustable con visor y cabeza fija de carraca



74WR-15/74WR-25

mm	Nm	Nm	€		
1/4 in	3-15 N·m	0.1 N·m	256,52	1	74WR-15
1/4 in	5-25 N·m	0.2 N·m	256,52	1	74WR-25

Llave dinamométrica mecánica de disparo ajustable con visor y cabeza de carraca fija con cuadradillo pasante



74WR-50/74WR-400

mm	Nm	Nm	€		
3/8"	10-50 N·m	0.5 N·m	239,42	1	74WR-50
3/8"	20-100 N·m	1 N·m	244,06	1	74WR-100B
1/2"	20-100 N·m	1 N·m	244,06	1	74WR-100
1/2"	40-200 N·m	2 N·m	244,06	1	74WR-200
1/2"	60-300 N·m	2 N·m	256,52	1	74WR-300
1/2"	60-340 N·m	5 N·m	280,95	1	74WR-340
3/4"	80-400 N·m	5 N·m	339,59	1	74WR-400

Llave dinamométrica de disparo mecánica ajustable con visor y cabeza intercambiable de conexión rectangular



74W9/74W14

mm	Nm	Nm	€		
9x12 mm	3-15 N·m	0.2 N·m	244,31	1	74W9-15
9x12 mm	5-25 N·m	0.2 N·m	243,09	1	74W9-25
9x12 mm	10-50 N·m	0.5 N·m	230,87	1	74W9-50

mm	Nm	Nm	€		
9x12 mm	20-100 N·m	1 N·m	230,87	1	74W9-100
9x12 mm	40-200 N·m	1 N·m	293,17	1	74W9-200
14x18 mm	40-200 N·m	2 N·m	293,17	1	74W14-200
14x18 mm	60-300 N·m	2 N·m	329,81	1	74W14-300
14x18 mm	80-400 N·m	5 N·m	390,89	1	74W14-400

Llave dinamométrica de disparo mecánica ajustable con visor y cabeza intercambiable de conexión cilíndrica



74WS-15/74WS-300

mm	Nm	Nm	€		
16 mm	3-15 N·m	0.2 N·m	244,31	1	74WS-15
16 mm	5-25 N·m	0.2 N·m	243,09	1	74WS-25
16 mm	10-50 N·m	0.5 N·m	230,87	1	74WS-50
16 mm	20-100 N·m	1 N·m	230,87	1	74WS-100
16 mm	40-200 N·m	2 N·m	293,17	1	74WS-200
16 mm	60-300 N·m	2 N·m	329,81	1	74WS-300

Llave dinamométrica mecánica de disparo ajustable con escala marcada y cabeza fija de carraca



7455

mm	Nm	Nm	€		
1/4 in	1-5 N·m	0.05 N·m	251,88	1	7455-5
1/4 in	3-15 N·m	0.1 N·m	251,88	1	7455-15
1/4 in	4-20 N·m	0.1 N·m	251,88	1	7455-20
1/4 in	5-25 N·m	0.1 N·m	251,88	1	7455-25
3/8 in	12-60 N·m	0.5 N·m	251,89	1	7455-60
3/8 in	20-100 N·m	0.5 N·m	251,89	1	7455-100
1/2 in	20-100 N·m	0.5 N·m	238,05	1	7455-100A
1/2 in	40-200 N·m	2 N·m	277,07	1	7455-200
1/2 in	60-300 N·m	2 N·m	311,00	1	7455-300
1/2 in	68-340 N·m	2 N·m	311,00	1	7455-340
3/4 in	100-500 N·m	5 N·m	629,71	1	7455-500
3/4 in	160-800 N·m	5 N·m	818,64	1	7455-800
1 in	200-1000 N·m	10 N·m	1.090,07	1	7455-1000

1/4" (7455-5); 3/8" (15-100); 1/2" (200-340) 3/4" (500-800); 1" (1500-2500)

Llave dinamométrica mecánica de disparo ajustable con escala marcada, cabeza fija de carraca y mango de dos secciones

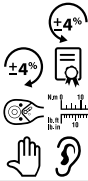

7455-1500

			€		
1 in	300-1500 N·m	10 N·m	1.390,00	1	7455-1500

Llave dinamométrica mecánica de disparo ajustable con escala marcada, cabeza intercambiable y mango de dos secciones

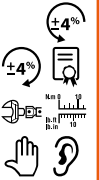

7465-1500

			€		
27x36 mm	300-1500 N·m	10 N·m	1.741,58	1	7465-1500

Llave dinamométrica mecánica de disparo ajustable con escala marcada y cabeza de cuadradillo fijo



7455-2500

			€		
1 in	500-2500 N·m	10 N·m	5.642,17	1	7455-2500

Cuadrado 1"

Llave dinamométrica mecánica de disparo ajustable con escala marcada y cabeza de carraca flexible



7456

			€		
3/8 in	10-80 lbf·ft	0.5 lbf·ft	314,87	1	7456-80LB

Libras pulgada 120-960

Llave dinamométrica mecánica de disparo ajustable con escala marcada y cabeza intercambiable

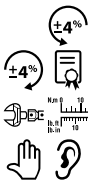

7465

			€		
9x12 mm	1-5 N·m	0.05 N·m	220,51	1	7465-5
9x12 mm	3-15 N·m	0.1 N·m	225,53	1	7465-15
9x12 mm	6-30 N·m	0.1 N·m	231,80	1	7465-30
9x12 mm	12-60 N·m	0.5 N·m	238,05	1	7465-60
9x12 mm	20-100 N·m	0.5 N·m	238,05	1	7465-100
14x18 mm	40-200 N·m	2 N·m	269,38	1	7465-200
14x18 mm	68-340 N·m	2 N·m	294,44	1	7465-340
24x32 mm	160-800 N·m	5 N·m	751,76	1	7465-800

Llave dinamométrica mecánica de disparo de accionamiento libre ajustable con cabeza fija de carraca



75R3/75R1

			€		
3/4" in	130-650 N·m	5 N·m	1.087,17	1	75R3-650
3/4" in	200-800 N·m	10 N·m	1.215,43	1	75R3-800
3/4" in	300-1000 N·m	10 N·m	1.453,62	1	75R3-1000
1" in	500-1500 N·m	10 N·m	1.360,00	1	75R1-1500



Llave dinamométrica mecánica de disparo de accionamiento libre ajustable con cabeza con conexión cilíndrica intercambiable



75S-650

			€		
22 mm	130-650 N·m	5 N·m	1.074,96	1	75S-650

Llave dinamométrica mecánica ajustable con cabeza de carraca fija y doble barra de ajuste



76R1-2000

			€		
1 in	900-2000 N·m	50 N·m	2.050,00	1	76R1-2000

Llave dinamométrica mecánica articulada ajustable de disparo con visor de escala y cabeza fija de carraca

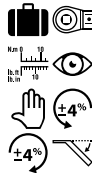

76R3

			€		
3/4-1 in	120-600 N·m	10 N·m	671,85	1	76R3-600
3/4-1 in	200-800 N·m	10 N·m	696,28	1	76R3-800
3/4-1 in	300-1000 N·m	20 N·m	726,81	1	76R3-1000

Llave dinamométrica mecánica de flexión de disparo con visor y cabeza intercambiable con conexión cilíndrica

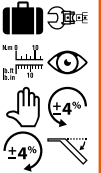

76S-600

			€		
22 mm	120-600 N·m	10 N·m	684,06	1	76S-600

Llave mecánica de par ajustable con cabeza de carraca fija



76R3-1500

			€		
3/4 in	700-1500 N·m	25 N·m	1.535,32	1	76R3-1500

Llave dinamométrica mecánica con escala, cabeza cuadrada fija y mango metálico

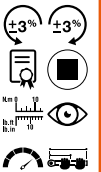

7454 M

			€		
1/4 in	0.7-3.5 N·m	0.1 N·m	326,51	1	7454-3.5
1/4 in	1.68-8.4 N·m	0.2 N·m	326,51	1	7454-8.4
3/8 in	3.4-17 N·m	0.5 N·m	326,51	1	7454-17
3/8 in	6.4-32 N·m	0.5 N·m	244,30	1	7454-32
3/8 in	14-70 N·m	1 N·m	347,11	1	7454-70A
1/2 in	28-140 N·m	5 N·m	465,56	1	7454-140A
1/2 in	46-230 N·m	10 N·m	473,80	1	7454-230
	160-800 N·m	20 N·m	834,30	1	7454-800A

Llave dinamométrica mecánica de dial, cuadradillo fijo y mango de metal

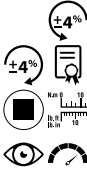

7454-480/7454-800

			€		
3/4 in	100-480 N·m	10 N·m	1.027,67	1	7454-480

Llave dinamométrica mecánica con dial, cuadradillo fijo y mango de dos secciones

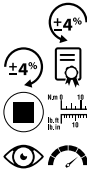

7454-1400

			€		
1 in	275-1400 N·m	25 N·m	2.340,84	1	7454-1400

Llave dinamométrica mecánica con dial/LED y cuadradillo fijo



7454-800E

			€		
3/4 in	160-800 N·m	20 N·m	1.712,80	1	7454-800E

Llave dinamométrica mecánica con dial/LED, cuadradillo fijo y mango de dos secciones



7454-1400E

			€		
1 in	275-1400 N·m	25 N·m	3.814,89	1	7454-1400E

Llave dinamométrica mecánica de disparo prefijada con cabeza fija de carraca



74PR-20

			€		
1/4 in	4-20 N·m	219 mm	195,45	1	74PR-20

El prefijado de la llave tiene un sobre coste de 15,00 € e incluye certificado de calibración

Llave dinamométrica mecánica de disparo prefijada con cabeza fija de carraca con cuadradillo por ambos lados



74PR-60/74PR-400

			€		
3/8 in	12-60 N·m	295 mm	205,21	1	74PR-60
1/2 in	12-60 N·m	301 mm	205,21	1	74PR-60A
3/8 in	20-100 N·m	335 mm	210,10	1	74PR-100
1/2 in	20-100 N·m	342 mm	210,10	1	74PR-100A
1/2 in	40-200 N·m	425 mm	213,77	1	74PR-200
1/2 in	60-300 N·m	668 mm	256,52	1	74PR-300
3/4 in	80-400 N·m	675 mm	299,27	1	74PR-400

El prefijado de la llave tiene un sobre coste de 15,00 € e incluye certificado de calibración



Llave dinamométrica mecánica prefijada con cabeza intercambiable de conexión rectangular y mango de plástico



74P9-20

mm	Nm	L	€		
9x12 mm	4-20 N·m	205 mm	195,45	1	74P9-20

El prefijado de la llave tiene un sobre coste de 15,00 € e incluye certificado de calibración

Llave dinamométrica mecánica prefijada con cabeza intercambiable de conexión rectangular y mango de goma



74P9-60/74P14-400

mm	Nm	L	€		
9x12 mm	12-60 N·m	286 mm	195,45	1	74P9-60
9x12 mm	20-100 N·m	326 mm	189,34	1	74P9-100
14x18 mm	40-200 N·m	403 mm	189,34	1	74P14-200
14x18 mm	60-300 N·m	534 mm	293,17	1	74P14-300
14x18 mm	80-400 N·m	652 mm	305,38	1	74P14-400

El prefijado de la llave tiene un sobre coste de 15,00 € e incluye certificado de calibración

Llave dinamométrica mecánica prefijada con cabeza intercambiable de conexión cilíndrica y mango de plástico



74PS-20

mm	Nm	L	€		
16 mm	4-20 N·m	206 mm	195,45	1	74PS-20

El prefijado de la llave tiene un sobre coste de 15,00 € e incluye certificado de calibración

Llave dinamométrica mecánica prefijada con cabeza intercambiable de conexión cilíndrica y mango de goma

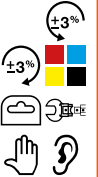

74PS-60/74PS-300

mm	Nm	L	€		
16 mm	12-60 N·m	283 mm	195,45	1	74PS-60
16 mm	20-100 N·m	324 mm	189,34	1	74PS-100
16 mm	40-200 N·m	405 mm	189,34	1	74PS-200
16 mm	60-300 N·m	643 mm	293,17	1	74PS-300

El prefijado de la llave tiene un sobre coste de 15,00 € e incluye certificado de calibración

Llave dinamométrica mecánica de disparo de accionamiento libre prefijado con cabeza fija de carraca



75P3/75P1

mm	Nm	L	€		
3/4 in	130-650 N·m	848 mm	1.087,17	1	75P3-650
3/4" in	200-800 N·m	1030 mm	1.191,00	1	75P3-800
3/4" in	300-1000 N·m	1238 mm	1.453,62	1	75P3-1000
1" in	500-1500 N·m	1563 mm	1.575,78	1	75P1-1500

El prefijado de la llave tiene un sobre coste de 15,00 € e incluye certificado de calibración

Llave dinamométrica mecánica de disparo de accionamiento libre prefijada con cabeza con conexión cilíndrica intercambiable



75PS-650

mm	Nm	L	€		
22 mm	130-650 N·m	800 mm	1.062,74	1	75PS-650

El prefijado de la llave tiene un sobre coste de 15,00 € e incluye certificado de calibración

Extensión para llaves de serie 75



75EXT

			€		
700 mm	60 mm	1.600 kg	238,20	1	75EXT

DESTORNILLADORES DINAMOMÉTRICOS

Destornillador digital de par y ángulo Bluetooth®



TASMB14H

		€		
1/4 in	0.04-0.7 N·m 0.01 N·m	1.606,98	1	TASMB14H007
1/4 in	0.45-9 N·m 0.01 N·m	1.644,36	1	TASMB14H09

Precisión: 20% a 100% de escala completa

Destornillador dinámico digital con memoria y USB



TASM14H

		€		
1/4 in	0.035-0.700 N·m	1.091,80	1	TASM14H007
1/4 in	0.45-9 N·m	1.122,70	1	TASM14H09

Destornillador dinámico angular electrónico



TAS14

			€		
1/4" in		0.04-0.7 N·m	707,85	1	TAS14H007
- in	1/4" in	0.04-0.7 N·m	707,85	1	TAS14S007
1/4" in		0.45-9 N·m	726,81	1	TAS14H09
	1/4" in	0.45-9 N·m	726,81	1	TAS14S09

PRECISIÓN: 20% a 100% de escala completa

Destornillador dinámico ajustable con visor de escala



6973N-6978N

			€		
1/4 in	16-80 cNm	1 cNm	297,00	1	6973N
1/4 in	40-200 cNm	2 cNm	303,90	1	6976N
1/4 in	90-450 cNm	5 cNm	310,61	1	6978N

Mini llave dinámica ajustable con punta fija



6852-5

			€		
1/4 in	1-5 N·m	0.1 N·m	271,19	1	6852-5



Set de mini llave dinamoétrica ajustable con punta fija



6852-5/S17

		€		
32 x 70 x 200 mm	0.29 kg	297,67	1	6852-5/S17

KM653-QR-1P	
6852-5	
6700SM-4	
59S/PH0, 59S/PH1	
59S/PZ0, 59S/PZ1	
59S/H1.5	
59S/0.8-5.5, 59S/0.6-4.5	
59S/T6, 59S/T7, 59S/T8	

Destornillador dinamoétrico ajustable con escala marcada en cN.m



TSS120

		€		
1/4 in	10-120 cNM	219,12	1	TSS120

Destornillador dinamoétrico ajustable con escala marcada en N.m



TSS600

		€		
1/4 in	1-6 N-m	219,12	1	TSS600

Destornillador dinamoétrico preajustable



6873N-6880N

		€		
7-70 cNM	1/4 in	273,57	1	6876N
15-170 cNM	1/4 in	280,40	1	6878N
45-450 cNM	1/4 in	310,60	1	6880N

El prefijado de la llave tiene un sobre coste de 15,00 € e incluye certificado de calibración

Mini llave dinamoétrica prefijada con punta fija



6852P-5

			€		
1/4" in	1-5 N-m	157 mm	305,38	1	6852P-5

El prefijado de la llave tiene un sobre coste de 15,00 € e incluye certificado de calibración

Destornillador dinamoétrico ERGO™ de par prefijado

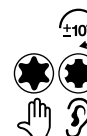

BE-6990

		€		
0.6 N-m	T6 IP6	59,83	1	BE-6990-IP6
0.9 N-m	T7 IP7	59,83	1	BE-6990-IP7
1.2 N-m	T8 IP8	59,83	1	BE-6990-IP8
1.4 N-m	T9 IP9	59,83	1	BE-6990-IP9
2 N-m	T10 IP10	59,83	1	BE-6990-IP10
3 N-m	T15 IP15	59,83	1	BE-6990-IP15

Juego de destornillador dinamométrico par prefijado ERGO™ con varillas intercambiables



ergo



BE-6990-IPSET

		€		
40 x 170 x 215 mm	0.755 kg	206,04	1	BE-6990-IPSET

BE-6990-IP7, BE-6990-IP8, BE-6990-IP9, BE-6990-IP15

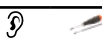

Varilla TORX para destornillador dinamométrico BE-6990



BE-6990TX-KL



			€		
T6	1.70 mm	160 mm	7,46	10	BE-6990TX-T6-KL
T7	1.99 mm	160 mm	7,46	10	BE-6990TX-T7-KL
T8	2.31 mm	160 mm	7,46	10	BE-6990TX-T8-KL
T9	2.50 mm	170 mm	7,46	10	BE-6990TX-T9-KL
T10	2.74 mm	170 mm	7,46	10	BE-6990TX-T10KL
T15	3.27 mm	170 mm	7,46	10	BE-6990TX-T15KL

Varilla TORX Plus para destornillador dinamométrico BE-6990



BE-6990-IP-KL



			€		
IP6	1.50 mm	170 mm	7,51	10	BE-6990-IP6-KL
IP7	1.99 mm	170 mm	7,51	10	BE-6990-IP7-KL
IP8	2.31 mm	170 mm	7,51	10	BE-6990-IP8-KL
IP9	2.50 mm	170 mm	7,51	10	BE-6990-IP9-KL
IP10	2.74 mm	170 mm	7,51	10	BE-6990-IP10-KL
IP15	3.27 mm	170 mm	7,51	10	BE-6990-IP15-KL

Varilla TORX Plus para destornillador dinamométrico BE-6990



BE-6990-IP20-KL

			€		
IP20	4.5 mm	90 mm	6,05	10	BE-6990-IP20-KL

Varilla de recambio para puntas TORX®



BE-6990TX-T20KL

			€		
T20	4.5 mm	92 mm	7,46	10	BE-6990TX-T20KL

MULTIPLICADORES

Multiplicador de par manual con compensación con brazos de reacción recto y acodado



89049TM-1000

			€		
1000 Nm - 3/4 in	4.8:1/4.9:1*	208/204 Nm - 1/2 in	1.575,78	1	89049TM-1000



Multiplicador de par manual con compensación con brazos de reacción recto y acodado



8905-TM/9505-TM

in	Ratio	in	€	Icons
1300 Nm - 3/4 in	5:1	260 Nm - 1/2 in	1.493,67	1 8905-TM
2700 Nm - 1 in	5:1	540 Nm - 3/4 in	1.493,67	1 9505-TM

Multiplicador de par manual con placa de reacción



9505

in	Ratio	in	€	Icons
3400 Nm - 1 in	5:1	680 Nm - 3/4 in	3.890,67	1 9505-3400

Multiplicador de par manual con placa de reacción y sistema de bloqueo de carraca



9525-9625

in	Ratio	in	€	Icons
3400 Nm - 1 in	25:1	136 Nm - 1/2 in	7.208,79	1 9525-3400
9500 Nm - 1.1/2 in	25:1	380 Nm - 3/4 in	6.437,50	1 9625-9500

Multiplicador de par manual con brazo de reacción recto



95155B/9526B

in	Ratio	in	€	Icons
3000 Nm - 1 in	15.5:1	193 Nm - 1/2 in	4.336,45	1 95155B-3000
4500 Nm - 1 in	26:1	173 Nm - 1/2 in	4.519,69	1 9526B-4500

Multiplicador de par manual compacto con brazo de reacción acodado



89222CR/96255CR

in	Ratio	in	€	Icons
1000 Nm - 3/4 in	22.2:1	45 Nm - 1/2 in	3.053,84	1 89222CR-1000
2000 Nm - 1 in	27:1	74 Nm - 1/2 in	3.359,23	1 9527CR-2000
4000 Nm - 1 in	25:1	160 Nm - 1/2 in	4.873,93	1 9525CR-4000
7000 Nm - 1.1/2 in	25.5:1	274 Nm - 1/2 in	6.101,57	1 96255CR-7000

COMPROBADORES DE PAR

Comprobadores multifunción para llaves y destornilladores dinamométricos



TEA003-TEA030

Nm	in	Nm	€	Icons
0.1-3.0 N·m	1/4 in	0.01 N·m	1.568,46	1 TEA003
0.5-10 N·m	1/4 in	0.01 N·m	1.568,46	1 TEA010
1.5-30 N·m	10 mm	0.1 N·m	1.493,77	1 TEA030
1.5-30 N·m	10 mm	0.1 N·m	1.493,50	1 TEA030A



Simuladores de Juntas para comprobadores de par



TJS

max	in	mm	€	Icons
3 N·m	1/4 in	31 mm	289,43	1 TJS003
10 N·m	1/4 in	31 mm	295,61	1 TJS010
30 N·m	1/4 in	31 mm	313,12	1 TJS030

Comprobador multifunción para llaves dinámicas



TEA065-TEA2100

mm	mm	in	€		
3-65 N·m	- mm	3/8 in	1.476,96	1	TEA065
10-350 N·m	- mm	1/2 in	1.459,73	1	TEA350
50-1100 N·m	27 mm	3/4 in	1.960,56	1	TEA1100
200-2100 N·m	27 mm		2.444,17	1	TEA2100

ADAPTADORES DE PAR Y ÁNGULO

Adaptador electrónico de ángulo y par



TAM

mm	N·m	€		
1/4 in	1,5-30 N·m	362,33	1	TAM1430
3/8 in	6,8-135 N·m	362,33	1	TAM38135
1/2 in	6,8-135 N·m	404,05	1	TAM12135
1/2 in	10-200 N·m	404,05	1	TAM12200
1/2 in	17-340 N·m	494,63	1	TAM12340

1/4" (TAM1430); 3/8" (TAM38135) 1/2"(TAM12135,12200,12340)

Goniómetro electrónico



MAM

mm	€		
0-360°	56 mm	248,76	1 MAM50M

Señal visual y de audio con 1 LED roja y 5 verdes

Goniómetro con imán



7851-M/8951-M

mm	mm	mm	€		
1/2 in	0-360	490 mm	154,49	1	7851-M
3/4 in	0-360	490 mm	237,90	1	8951-M

Goniómetro con pinza



7851-G

mm	mm	mm	€		
1/2 in	0-360	555 mm	172,89	1	7851-G

HERRAMIENTAS DE INSERCIÓN

Cabeza intercambiable redonda de carraca reversible con conector rectangular



9/14/24/27R





mm	mm	N·m	€		
1/4 in	9x12 mm	30 N·m	62,64	1	9R-1/4
3/8 in	9x12 mm	135 N·m	65,16	1	9R-3/8
1/2 in	9x12 mm	160 N·m	66,41	1	9R-1/2
1/2 in	14x18 mm	340 N·m	70,17	1	14R-1/2
3/4 in	14x18 mm	420 N·m	112,76	1	14R-3/4
3/4 in	24x32 mm	1000 N·m	181,68	1	24R-3/4
1 in	24x32 mm	1200 N·m	300,70	1	24R-1
1 in	27x36 mm	2500 N·m	344,56	1	27R-1



Cabeza intercambiable con cuadradillo pasante de carraca con conector rectangular







9/14/24/27T

				€		
1/4 in	9x12 mm	30 N·m	70,17	1	9T-1/4	
3/8 in	9x12 mm	135 N·m	75,18	1	9T-3/8	
1/2 in	9x12 mm	160 N·m	80,18	1	9T-1/2	
1/2 in	14x18 mm	340 N·m	90,21	1	14T-1/2	
3/4 in	14x18 mm	420 N·m	162,88	1	14T-3/4	
3/4 in	24x32 mm	1000 N·m	275,64	1	24T-3/4	
1 in	24x32 mm	1200 N·m	363,36	1	24T-1	
1 in	27x36 mm	2500 N·m	400,94	1	27T-1	

Cabeza intercambiable cuadrada fija con conector rectangular







9/14/24/27F





				€		
1/4 in	9x12 mm	30 N·m	38,85	1	9F-1/4	
3/8 in	9x12 mm	135 N·m	38,85	1	9F-3/8	
1/2 in	9x12 mm	160 N·m	40,09	1	9F-1/2	
1/2 in	14x18 mm	340 N·m	42,60	1	14F-1/2	
3/4 in	14x18 mm	420 N·m	71,42	1	14F-3/4	
3/4 in	24x32 mm	1000 N·m	230,54	1	24F-3/4	
1 in	24x32 mm	1200 N·m	269,38	1	24F-1	
1 in	27x36 mm	2500 N·m	319,51	1	27F-1	

Cabeza intercambiable de carraca tipo pera con conector rectangular



9/14P





				€		
1/4 in	9x12 mm	30 N·m	83,96	1	9P-1/4	
3/8 in	9x12 mm	135 N·m	86,46	1	9P-3/8	

				€		
1/2 in	9x12 mm	160 N·m	88,96	1	9P-1/2	
1/2 in	14x18 mm	340 N·m	100,24	1	14P-1/2	

Cabeza intercambiable de carraca tipo pera con liberación rápida y conector rectangular







9/14Q

				€		
1/4 in	9x12 mm	30 N·m	97,72	1	9Q-1/4	
3/8 in	9x12 mm	135 N·m	100,24	1	9Q-3/8	
1/2 in	9x12 mm	160 N·m	102,74	1	9Q-1/2	
1/2 in	14x18 mm	340 N·m	110,26	1	14Q-1/2	

Cabeza intercambiable de carraca portapuntas con conector rectangular



9B

			€		
1/4 in	9x12 mm	60,13	1	9B-1/4	
5/16 in	9x12 mm	81,44	1	9B-5/16	

Cabeza intercambiable de boca fija con conector rectangular métrica



9/14/24/277

			€		
7 mm	9x12 mm	9 N·m	27,56	1	97-7
8 mm	9x12 mm	13 N·m	27,56	1	97-8
9 mm	9x12 mm	18 N·m	27,56	1	97-9
10 mm	9x12 mm	24 N·m	27,56	1	97-10
11 mm	9x12 mm	32 N·m	27,56	1	97-11
12 mm	9x12 mm	41 N·m	27,56	1	97-12
13 mm	9x12 mm	51 N·m	27,56	1	97-13
14 mm	9x12 mm	63 N·m	27,55	1	97-14
15 mm	9x12 mm	77 N·m	27,55	1	97-15
16 mm	9x12 mm	92 N·m	27,56	1	97-16
17 mm	9x12 mm	109 N·m	27,56	1	97-17
18 mm	9x12 mm	125 N·m	27,56	1	97-18
19 mm	9x12 mm	145 N·m	27,56	1	97-19
21 mm	9x12 mm	160 N·m	46,20	1	97-21
22 mm	9x12 mm	160 N·m	53,22	1	97-22
24 mm	9x12 mm	160 N·m	53,22	1	97-24
27 mm	9x12 mm	160 N·m	48,76	1	97-27
30 mm	9x12 mm	160 N·m	47,62	1	97-30
32 mm	9x12 mm	160 N·m	47,62	1	97-32
13 mm	14x18 mm	51 N·m	31,33	1	147-13
14 mm	14x18 mm	63 N·m	31,33	1	147-14
15 mm	14x18 mm	77 N·m	31,33	1	147-15
16 mm	14x18 mm	92 N·m	31,33	1	147-16
17 mm	14x18 mm	109 N·m	31,33	1	147-17
18 mm	14x18 mm	125 N·m	31,33	1	147-18
19 mm	14x18 mm	145 N·m	31,33	1	147-19
21 mm	14x18 mm	190 N·m	37,58	1	147-21
22 mm	14x18 mm	220 N·m	37,58	1	147-22
24 mm	14x18 mm	280 N·m	37,58	1	147-24
25 mm	14x18 mm	320 N·m	42,60	1	147-25
27 mm	14x18 mm	360 N·m	42,60	1	147-27
30 mm	14x18 mm	360 N·m	42,60	1	147-30
32 mm	14x18 mm	360 N·m	42,60	1	147-32
33 mm	14x18 mm	360 N·m	46,37	1	147-33
34 mm	14x18 mm	360 N·m	46,37	1	147-34
35 mm	14x18 mm	360 N·m	46,37	1	147-35
36 mm	14x18 mm	360 N·m	46,37	1	147-36
37 mm	14x18 mm	360 N·m	48,87	1	147-37
38 mm	14x18 mm	360 N·m	48,87	1	147-38
39 mm	14x18 mm	360 N·m	48,87	1	147-39
41 mm	14x18 mm	360 N·m	48,87	1	147-41
45 mm	14x18 mm	360 N·m	172,91	1	147-45
46 mm	14x18 mm	360 N·m	172,91	1	147-46
50 mm	14x18 mm	360 N·m	179,17	1	147-50
55 mm	14x18 mm	360 N·m	192,95	1	147-55
60 mm	14x18 mm	360 N·m	206,73	1	147-60
65 mm	14x18 mm	360 N·m	211,15	1	147-65
68 mm	14x18 mm	360 N·m	233,04	1	147-68
70 mm	14x18 mm	360 N·m	233,04	1	147-70
75 mm	14x18 mm	360 N·m	273,13	1	147-75
90 mm	14x18 mm	360 N·m	345,81	1	147-90
24 mm	24x32 mm	1200 N·m	191,71	1	247-24
27 mm	24x32 mm	1200 N·m	191,71	1	247-27

			€		
30 mm	24x32 mm	1200 N·m	194,22	1	247-30
32 mm	24x32 mm	1200 N·m	194,22	1	247-32
34 mm	24x32 mm	1200 N·m	194,22	1	247-34
36 mm	24x32 mm	1200 N·m	199,22	1	247-36
41 mm	24x32 mm	1200 N·m	199,22	1	247-41
46 mm	24x32 mm	1200 N·m	202,97	1	247-46
50 mm	24x32 mm	1200 N·m	207,98	1	247-50
55 mm	24x32 mm	1200 N·m	214,26	1	247-55
60 mm	24x32 mm	1200 N·m	218,01	1	247-60
30 mm	27x36 mm	3000 N·m	214,26	1	277-30
32 mm	27x36 mm	3000 N·m	214,26	1	277-32
34 mm	27x36 mm	3000 N·m	214,26	1	277-34
36 mm	27x36 mm	3000 N·m	219,26	1	277-36
41 mm	27x36 mm	3000 N·m	240,56	1	277-41
46 mm	27x36 mm	3000 N·m	245,57	1	277-46
50 mm	27x36 mm	3000 N·m	251,85	1	277-50
55 mm	27x36 mm	3000 N·m	259,35	1	277-55
60 mm	27x36 mm	3000 N·m	264,37	1	277-60

Cabeza intercambiable de boca fija con conector rectangular pulgadas



9/14/24/277"





			€		
1/4 in	9x12 mm	6 N·m	28,83	1	97-1/4
5/16 in	9x12 mm	13 N·m	28,83	1	97-5/16
3/8 in	9x12 mm	24 N·m	28,83	1	97-3/8
7/16 in	9x12 mm	32 N·m	28,83	1	97-7/16
1/2 in	9x12 mm	51 N·m	28,83	1	97-1/2
17/32 in	9x12 mm	63 N·m	28,83	1	97-17/32
9/16 in	9x12 mm	77 N·m	28,83	1	97-9/16
5/8 in	9x12 mm	92 N·m	28,83	1	97-5/8
11/16 in	9x12 mm	125 N·m	28,83	1	97-11/16
3/4 in	9x12 mm	145 N·m	28,83	1	97-3/4
13/16 in	9x12 mm	160 N·m	45,11	1	97-13/16
7/8 in	9x12 mm	160 N·m	45,11	1	97-7/8
15/16 in	9x12 mm	160 N·m	47,62	1	97-15/16
1 in	9x12 mm	160 N·m	47,62	1	97-1
7/16 in	14x18 mm	32 N·m	35,08	1	147-7/16
1/2 in	14x18 mm	51 N·m	35,08	1	147-1/2
9/16 in	14x18 mm	77 N·m	35,08	1	147-9/16
5/8 in	14x18 mm	92 N·m	35,08	1	147-5/8
11/16 in	14x18 mm	109 N·m	35,08	1	147-11/16
3/4 in	14x18 mm	145 N·m	35,08	1	147-3/4
13/16 in	14x18 mm	190 N·m	40,09	1	147-13/16
7/8 in	14x18 mm	220 N·m	40,09	1	147-7/8
15/16 in	14x18 mm	280 N·m	40,09	1	147-15/16
1 in	14x18 mm	360 N·m	40,09	1	147-1
1 1/8 in	14x18 mm	360 N·m	40,09	1	147-1.1/8
1 1/4 in	14x18 mm	360 N·m	42,60	1	147-1.1/4







Cabeza intercambiable de boca estrella con conector rectangular métrica



9/14/24/278





			€		
7 mm	9x12 mm	25 N·m	30,08	1	98-7
8 mm	9x12 mm	34 N·m	30,08	1	98-8
9 mm	9x12 mm	45 N·m	30,08	1	98-9
10 mm	9x12 mm	58 N·m	30,08	1	98-10
11 mm	9x12 mm	47 N·m	30,08	1	98-11
12 mm	9x12 mm	89 N·m	30,08	1	98-12
13 mm	9x12 mm	105 N·m	30,08	1	98-13
14 mm	9x12 mm	125 N·m	30,08	1	98-14
15 mm	9x12 mm	145 N·m	30,08	1	98-15
16 mm	9x12 mm	160 N·m	30,08	1	98-16
17 mm	9x12 mm	160 N·m	30,08	1	98-17
18 mm	9x12 mm	160 N·m	30,08	1	98-18
19 mm	9x12 mm	160 N·m	30,08	1	98-19
21 mm	9x12 mm	160 N·m	30,08	1	98-21
22 mm	9x12 mm	160 N·m	30,08	1	98-22
13 mm	14x18 mm	105 N·m	32,57	1	148-13
14 mm	14x18 mm	125 N·m	32,57	1	148-14
15 mm	14x18 mm	150 N·m	32,57	1	148-15
16 mm	14x18 mm	175 N·m	32,57	1	148-16
17 mm	14x18 mm	200 N·m	32,57	1	148-17
18 mm	14x18 mm	230 N·m	32,57	1	148-18
19 mm	14x18 mm	260 N·m	32,57	1	148-19
21 mm	14x18 mm	330 N·m	37,58	1	148-21
22 mm	14x18 mm	360 N·m	37,58	1	148-22
24 mm	14x18 mm	360 N·m	37,58	1	148-24
27 mm	14x18 mm	360 N·m	37,58	1	148-27
28 mm	14x18 mm	360 N·m	42,60	1	148-28
30 mm	14x18 mm	360 N·m	42,60	1	148-30
32 mm	14x18 mm	360 N·m	42,60	1	148-32
34 mm	14x18 mm	360 N·m	46,37	1	148-34
36 mm	14x18 mm	360 N·m	46,37	1	148-36
41 mm	14x18 mm	360 N·m	46,37	1	148-41
24 mm	24x32 mm	1200 N·m	195,46	1	248-24
27 mm	24x32 mm	1200 N·m	195,46	1	248-27
30 mm	24x32 mm	1200 N·m	200,47	1	248-30
32 mm	24x32 mm	1200 N·m	200,47	1	248-32
34 mm	24x32 mm	1200 N·m	200,47	1	248-34
36 mm	24x32 mm	1200 N·m	204,23	1	248-36
41 mm	24x32 mm	1200 N·m	214,26	1	248-41
46 mm	24x32 mm	1200 N·m	209,25	1	248-46
50 mm	24x32 mm	1200 N·m	209,25	1	248-50
55 mm	24x32 mm	1200 N·m	255,59	1	248-55
60 mm	24x32 mm	1200 N·m	255,59	1	248-60
30 mm	27x36 mm	3000 N·m	243,06	1	278-30
32 mm	27x36 mm	1240 N·m	243,06	1	278-32
34 mm	27x36 mm	3000 N·m	243,06	1	278-34
36 mm	27x36 mm	3000 N·m	246,82	1	278-36
41 mm	27x36 mm	3000 N·m	259,35	1	278-41

			€		
46 mm	27x36 mm	3000 N·m	253,09	1	278-46
50 mm	27x36 mm	3000 N·m	253,09	1	278-50
55 mm	27x36 mm	3000 N·m	255,59	1	278-55
60 mm	27x36 mm	3000 N·m	255,59	1	278-60

Cabeza intercambiable de boca estrella con conector rectangular pulgadas







9/14/24/278"





			€		
1/4 in	9x12 mm	25 N·m	30,08	1	98-1/4
5/16 in	9x12 mm	34 N·m	30,08	1	98-5/16
3/8 in	9x12 mm	58 N·m	30,08	1	98-3/8
7/16 in	9x12 mm	72 N·m	30,08	1	98-7/16
1/2 in	9x12 mm	105 N·m	30,08	1	98-1/2
9/16 in	9x12 mm	125 N·m	30,08	1	98-9/16
5/8 in	9x12 mm	160 N·m	30,08	1	98-5/8
11/16 in	9x12 mm	160 N·m	30,08	1	98-11/16
3/4 in	9x12 mm	57 N·m	30,08	1	98-3/4
13/16 in	14x18 mm	330 N·m	42,60	1	148-13/16
13/16 in	9x12 mm	160 N·m	31,33	1	98-13/16
7/8 in	9x12 mm	160 N·m	31,33	1	98-7/8
1/2 in	14x18 mm	105 N·m	35,08	1	148-1/2
9/16 in	14x18 mm	150 N·m	35,08	1	148-9/16
5/8 in	14x18 mm	175 N·m	35,08	1	148-5/8
11/16 in	14x18 mm	230 N·m	35,08	1	148-11/16
3/4 in	14x18 mm	260 N·m	35,08	1	148-3/4
15/16 in	14x18 mm	360 N·m	42,60	1	148-15/16
7/8 in	14x18 mm	360 N·m	42,60	1	148-7/8
1 in	14x18 mm	360 N·m	42,60	1	148-1

Cabeza intercambiable para racores con conector rectangular







99 in

			€		
3/8 in	9x12 mm	9 N·m	33,84	1	99-3/8
7/16 in	9x12 mm	16 N·m	33,84	1	99-7/16
1/2 in	9x12 mm	28 N·m	33,84	1	99-1/2

			€		
9/16 in	9x12 mm	31 N·m	33,84	1	99-9/16
5/8 in	9x12 mm	46 N·m	33,84	1	99-5/8
11/16 in	9x12 mm	65 N·m	35,08	1	99-11/16
3/4 in	9x12 mm	74 N·m	35,08	1	99-3/4





Cabeza intercambiable para racores con conector rectangular



			€		
10 mm	9x12 mm	14 N·m	31,33	1	99-10
11 mm	9x12 mm	19 N·m	31,33	1	99-11
12 mm	9x12 mm	24 N·m	31,33	1	99-12
13 mm	9x12 mm	30 N·m	31,33	1	99-13
14 mm	9x12 mm	37 N·m	31,33	1	99-14
16 mm	9x12 mm	46 N·m	32,57	1	99-16
17 mm	9x12 mm	55 N·m	32,57	1	99-17
18 mm	9x12 mm	65 N·m	32,57	1	99-18
19 mm	9x12 mm	74 N·m	32,57	1	99-19
21 mm	9x12 mm	87 N·m	32,57	1	99-21
22 mm	9x12 mm	96 N·m	32,57	1	99-22
24 mm	9x12 mm	96 N·m	36,34	1	99-24

Adaptador para cabezas intercambiables con conector rectangular







			€		
9x12 mm	14x18 mm	160 N·m	58,89	1	9A-14
14x18 mm	9x12 mm	160 N·m	75,18	1	14A-9
14x18 mm	24x32 mm	360 N·m	102,74	1	14A-32
24x32 mm	14x18 mm	360 N·m	111,51	1	24A-14
24x32 mm	27x36 mm	1200 N·m	176,67	1	24A-27
27x36 mm	24x32 mm	1200 N·m	209,25	1	27A-24

Cabeza intercambiable para soldar con conector rectangular







9/14/24W

		€		
9x12 mm	23.8 mm	40,46	1	9W
14x18 mm	38 mm	42,60	1	14W
24x32 mm	65 mm	68,92	1	24W

Cabeza de carraca redonda intercambiable con conector cilindrico







16R/22R

			€		
1/4" in	16 mm	20 N·m	101,01	1	16R-1/4
3/8" in	16 mm	160 N·m	101,01	1	16R-3/8
1/2" in	16 mm	420 N·m	101,01	1	16R-1/2
3/4" in	22 mm	1200 N·m	256,52	1	22R-3/4

Cabeza intercambiable de cuadradillo pasante con conector cilindrico



16F/22F





			€		
1/4" in	16 mm	20 N·m	79,54	1	16F-1/4
3/8" in	16 mm	160 N·m	79,54	1	16F-3/8
1/2" in	16 mm	420 N·m	79,54	1	16F-1/2
3/4" in	22 mm	1200 N·m	250,98	1	22F-3/4



Cabeza intercambiable llave fija mm con conector cilíndrico







167/227

			€		
mm	mm	mm			
7 mm	16 mm	9 N·m	52,51	1	167-7
8 mm	16 mm	13 N·m	52,51	1	167-8
9 mm	16 mm	18 N·m	52,51	1	167-9
10 mm	16 mm	24 N·m	52,51	1	167-10
11 mm	16 mm	32 N·m	52,51	1	167-11
12 mm	16 mm	41 N·m	54,26	1	167-12
13 mm	16 mm	51 N·m	54,26	1	167-13
14 mm	16 mm	63 N·m	54,26	1	167-14
15 mm	16 mm	77 N·m	54,26	1	167-15
16 mm	16 mm	92 N·m	55,63	1	167-16
17 mm	16 mm	109 N·m	55,63	1	167-17
18 mm	16 mm	125 N·m	59,93	1	167-18
19 mm	16 mm	145 N·m	65,12	1	167-19
20 mm	16 mm	160 N·m	65,36	1	167-20
21 mm	16 mm	190 N·m	70,75	1	167-21
22 mm	16 mm	220 N·m	88,47	1	167-22
23 mm	16 mm	250 N·m	88,47	1	167-23
24 mm	16 mm	280 N·m	88,47	1	167-24
25 mm	16 mm	320 N·m	106,91	1	167-25
26 mm	16 mm	360 N·m	106,91	1	167-26
27 mm	16 mm	360 N·m	106,91	1	167-27
28 mm	16 mm	360 N·m	106,91	1	167-28
30 mm	16 mm	360 N·m	106,91	1	167-30
32 mm	16 mm	360 N·m	106,91	1	167-32
36 mm	16 mm	360 N·m	132,55	1	167-36
22 mm	22 mm	1200 N·m	201,54	1	227-22
24 mm	22 mm	1200 N·m	207,53	1	227-24
27 mm	22 mm	1200 N·m	213,62	1	227-27
30 mm	22 mm	1200 N·m	222,35	1	227-30
32 mm	22 mm	1200 N·m	226,60	1	227-32
34 mm	22 mm	1200 N·m	250,13	1	227-34
36 mm	22 mm	1200 N·m	256,50	1	227-36
41 mm	22 mm	1200 N·m	278,00	1	227-41
46 mm	22 mm	1200 N·m	333,50	1	227-46

Cabeza intercambiable llave fija pulgadas con conector cilíndrico







167





			€		
in	mm	mm			
5/16 in	16 mm	34 N·m	55,86	1	167-5/16
3/8 in	16 mm	45 N·m	55,86	1	167-3/8
7/16 in	16 mm	72 N·m	57,73	1	167-7/16
1/2 in	16 mm	51 N·m	57,73	1	167-1/2
9/16 in	16 mm	77 N·m	57,73	1	167-9/16
5/8 in	16 mm	92 N·m	59,15	1	167-5/8
11/16 in	16 mm	109 N·m	56,19	1	167-11/16
3/4 in	16 mm	145 N·m	65,98	1	167-3/4
13/16 in	16 mm	190 N·m	75,28	1	167-13/16
7/8 in	16 mm	220 N·m	94,08	1	167-7/8
15/16 in	16 mm	280 N·m	94,08	1	167-15/16
1 in	16 mm	360 N·m	113,71	1	167-1
1.1/16 in	16 mm	360 N·m	113,71	1	167-1.1/16
1.1/8 in	16 mm	360 N·m	113,71	1	167-1.1/8
1.3/16 in	16 mm	360 N·m	113,71	1	167-1.3/16
1.1/4 in	16 mm	360 N·m	113,71	1	167-1.1/4

Cabeza intercambiable de boca estrella con conector cilíndrico métrica



168/228





			€		
mm	mm	mm			
7 mm	16 mm	25 N·m	55,11	1	168-7
8 mm	16 mm	34 N·m	55,11	1	168-8
9 mm	16 mm	45 N·m	55,11	1	168-9
10 mm	16 mm	58 N·m	55,11	1	168-10
11 mm	16 mm	72 N·m	55,11	1	168-11
12 mm	16 mm	89 N·m	56,95	1	168-12

 mm	 mm	 máx	€		
13 mm	16 mm	105 N·m	56,95	1	168-13
14 mm	16 mm	125 N·m	56,95	1	168-14
15 mm	16 mm	150 N·m	56,95	1	168-15
16 mm	16 mm	175 N·m	58,40	1	168-16
17 mm	16 mm	200 N·m	58,40	1	168-17
18 mm	16 mm	230 N·m	62,86	1	168-18
19 mm	16 mm	260 N·m	65,12	1	168-19
20 mm	16 mm	290 N·m	68,64	1	168-20
21 mm	16 mm	330 N·m	74,23	1	168-21
22 mm	16 mm	360 N·m	92,84	1	168-22
23 mm	16 mm	360 N·m	92,84	1	168-23
24 mm	16 mm	360 N·m	92,84	1	168-24
26 mm	16 mm	360 N·m	112,30	1	168-26
27 mm	16 mm	360 N·m	112,30	1	168-27
22 mm	22 mm	1200 N·m	224,50	1	228-22
24 mm	22 mm	1200 N·m	224,50	1	228-24
27 mm	22 mm	1200 N·m	224,50	1	228-27
30 mm	22 mm	1200 N·m	233,43	1	228-30
32 mm	22 mm	1200 N·m	238,02	1	228-32
34 mm	22 mm	1200 N·m	255,96	1	228-34
36 mm	22 mm	1200 N·m	269,40	1	228-36
41 mm	22 mm	1200 N·m	291,83	1	228-41
46 mm	22 mm	1200 N·m	350,20	1	228-46

Cabeza intercambiable de boca estrella con conector cilíndrico pulgadas







168

 in	 mm	 máx	€		
5/16 in	16 mm	34 N·m	58,64	1	168-5/16
3/8 in	16 mm	58 N·m	58,64	1	168-3/8
7/16 in	16 mm	89 N·m	58,64	1	168-7/16
1/2 in	16 mm	105 N·m	60,55	1	168-1/2
9/16 in	16 mm	125 N·m	60,55	1	168-9/16
5/8 in	16 mm	125 N·m	62,11	1	168-5/8
11/16 in	16 mm	125 N·m	56,19	1	168-11/16
3/4 in	16 mm	260 N·m	73,02	1	168-3/4
13/16 in	16 mm	290 N·m	73,02	1	168-13/16
7/8 in	16 mm	360 N·m	98,77	1	168-7/8
15/16 in	16 mm	360 N·m	98,77	1	168-15/16
1 in	16 mm	360 N·m	119,42	1	168-1
1.1/16 in	16 mm	360 N·m	119,42	1	168-1.1/16
1.3/16 in	16 mm	360 N·m	140,10	1	168-1.3/16

Cabeza intercambiable para racores con conector cilíndrico



169

 mm	 mm	 máx	€		
7 mm	16 mm	6 N·m	57,89	1	169-7
8 mm	16 mm	8 N·m	57,89	1	169-8
9 mm	16 mm	10 N·m	57,89	1	169-9
10 mm	16 mm	12 N·m	57,89	1	169-10
11 mm	16 mm	16 N·m	57,89	1	169-11
12 mm	16 mm	16 N·m	59,88	1	169-12
13 mm	16 mm	28 N·m	59,88	1	169-13
14 mm	16 mm	31 N·m	59,88	1	169-14
15 mm	16 mm	38 N·m	59,88	1	169-15
16 mm	16 mm	46 N·m	61,25	1	169-16
17 mm	16 mm	53 N·m	61,25	1	169-17
18 mm	16 mm	65 N·m	66,06	1	169-18
19 mm	16 mm	74 N·m	68,40	1	169-19
20 mm	16 mm	86 N·m	72,00	1	169-20
21 mm	16 mm	100 N·m	77,99	1	169-21
22 mm	16 mm	115 N·m	97,56	1	169-22
23 mm	16 mm	125 N·m	97,56	1	169-23
24 mm	16 mm	145 N·m	97,56	1	169-24
27 mm	16 mm	160 N·m	117,82	1	169-27

JUEGOS DE MALETAS VACÍAS PARA HERRAMIENTAS DINAMOMÉTRICAS

Maletas vacías de doble pared que absorben los impactos para herramientas dinamo-métricas



4750BMCT

 kg	€		
0.95 kg	30,80	1	4750BMCT1





BAHCO



Accesorios para herramientas eléctricas



CORONAS DE SIERRA

Corona de sierra Sandflex®, bi-metal



3830

	€		
14 mm	11,87	1	3830-14-C
16 mm	11,87	1	3830-16-C
17 mm	11,87	1	3830-17-C
19 mm	11,87	1	3830-19-C
20 mm	11,87	1	3830-20-C
21 mm	11,87	1	3830-21-C
22 mm	11,87	1	3830-22-C
24 mm	11,87	1	3830-24-C
25 mm	11,99	1	3830-25-C
27 mm	12,63	1	3830-27-C
29 mm	12,63	1	3830-29-C
30 mm	12,63	1	3830-30-C
32 mm	12,63	1	3830-32-C
33 mm	12,63	1	3830-33-C
35 mm	14,28	1	3830-35-C
37 mm	14,28	1	3830-37-C
38 mm	14,28	1	3830-38-C
40 mm	14,28	1	3830-40-C
41 mm	14,28	1	3830-41-C
43 mm	14,28	1	3830-43-C
44 mm	16,30	1	3830-44-C
46 mm	16,30	1	3830-46-C
48 mm	16,30	1	3830-48-C
50 mm	16,30	1	3830-50-C
51 mm	16,30	1	3830-51-C
52 mm	19,70	1	3830-52-C
54 mm	19,70	1	3830-54-C
55 mm	19,70	1	3830-55-C
56 mm	19,70	1	3830-56-C
57 mm	19,70	1	3830-57-C
59 mm	19,70	1	3830-59-C
60 mm	19,70	1	3830-60-C
64 mm	21,73	1	3830-64-C
65 mm	21,73	1	3830-65-C
67 mm	21,73	1	3830-67-C
68 mm	21,73	1	3830-68-C
70 mm	21,73	1	3830-70-C
73 mm	21,73	1	3830-73-C
76 mm	24,63	1	3830-76-C
79 mm	24,63	1	3830-79-C
83 mm	24,63	1	3830-83-C
86 mm	24,63	1	3830-86-C
89 mm	24,63	1	3830-89-C
92 mm	28,54	1	3830-92-C
95 mm	30,94	1	3830-95-C
98 mm	32,34	1	3830-98-C
102 mm	34,74	1	3830-102-C
105 mm	36,63	1	3830-105-C
108 mm	42,82	1	3830-108-C

	€		
111 mm	49,89	1	3830-111-C
114 mm	55,58	1	3830-114-C
121 mm	61,89	1	3830-121-C
127 mm	67,57	1	3830-127-C
133 mm	72,62	1	3830-133-C
140 mm	77,67	1	3830-140-C
146 mm	80,83	1	3830-146-C
152 mm	88,41	1	3830-152-C
14 mm	11,87	6	3830-14-VIP
16 mm	11,87	6	3830-16-VIP
17 mm	11,87	6	3830-17-VIP
19 mm	11,87	6	3830-19-VIP
20 mm	11,87	6	3830-20-VIP
21 mm	11,87	6	3830-21-VIP
22 mm	11,87	6	3830-22-VIP
24 mm	11,87	6	3830-24-VIP
25 mm	11,99	6	3830-25-VIP
27 mm	12,63	6	3830-27-VIP
29 mm	12,63	6	3830-29-VIP
30 mm	12,63	6	3830-30-VIP
32 mm	12,63	6	3830-32-VIP
33 mm	12,63	6	3830-33-VIP
35 mm	14,28	6	3830-35-VIP
37 mm	14,28	6	3830-37-VIP
38 mm	14,28	6	3830-38-VIP
40 mm	14,28	6	3830-40-VIP
41 mm	14,28	6	3830-41-VIP
43 mm	14,28	6	3830-43-VIP
44 mm	16,30	6	3830-44-VIP
46 mm	16,30	6	3830-46-VIP
48 mm	16,30	6	3830-48-VIP
50 mm	16,30	6	3830-50-VIP
51 mm	16,30	6	3830-51-VIP
52 mm	19,70	4	3830-52-VIP
54 mm	19,70	4	3830-54-VIP
55 mm	19,70	4	3830-55-VIP
56 mm	19,70	4	3830-56-VIP
57 mm	19,70	4	3830-57-VIP
59 mm	19,70	4	3830-59-VIP
60 mm	19,70	4	3830-60-VIP
62 mm	21,45	4	3830-62-VIP
64 mm	21,73	4	3830-64-VIP
65 mm	21,73	4	3830-65-VIP
67 mm	21,73	4	3830-67-VIP
68 mm	21,73	4	3830-68-VIP
70 mm	21,73	4	3830-70-VIP
73 mm	21,73	4	3830-73-VIP
76 mm	24,63	4	3830-76-VIP
79 mm	24,63	4	3830-79-VIP
83 mm	24,63	4	3830-83-VIP
86 mm	24,63	4	3830-86-VIP
89 mm	24,63	4	3830-89-VIP
92 mm	28,54	4	3830-92-VIP
95 mm	30,94	4	3830-95-VIP
98 mm	32,34	4	3830-98-VIP
102 mm	34,74	4	3830-102-VIP
105 mm	36,63	4	3830-105-VIP
108 mm	42,82	4	3830-108-VIP
111 mm	49,89	4	3830-111-VIP
114 mm	55,58	4	3830-114-VIP
121 mm	61,89	1	3830-121-VIP
127 mm	67,57	1	3830-127-VIP
133 mm	72,62	1	3830-133-VIP
140 mm	77,67	1	3830-140-VIP
146 mm	80,83	1	3830-146-VIP
152 mm	88,41	1	3830-152-VIP
168 mm	114,84	1	3830-168
177 mm	158,10	1	3830-177-HIGH
210 mm	172,27	1	3830-210

Juego de 4 coronas Sandflex® bi-metales



3830-4P

X		€		
4	19 mm	17,52	1	3830-19-4P
4	20 mm	18,67	1	3830-20-4P
4	22 mm	30,97	1	3830-22-4P
4	25 mm	34,13	1	3830-25-4P
4	27 mm	32,45	1	3830-27-4P
4	29 mm	32,72	1	3830-29-4P
4	30 mm	33,00	1	3830-30-4P
4	32 mm	35,04	1	3830-32-4P
4	35 mm	35,82	1	3830-35-4P

Juego de coronas bi-metales Sandflex®
20x4mm + 25x4 mm



3834-CP-20/25

g	€		
600 g	62,88	1	3834-CP-20/25

3830-20-Cx 4, 3830-25-Cx 4

3834-ARBR-930

3834-DRLx 2



Juego de coronas bi-metales Sandflex® 20 mm-76 mm



3834-PROMO-82

	€		
1188 g	91,19	1	3834-PROMO-82

- 3830-20-C, 3830-25-C, 3830-30-C, 3830-35-C, 3830-44-C, 3830-51-C, 3830-64-C, 3830-76-C
- 3834-ARBR-930
- 3834-ARBR-11152QC

Juego de coronas bi-metales Sandflex® 16 mm-44 mm



3834-PROMO-122

	€		
1100 g	110,00	1	3834-PROMO-122

- 3830-16-C, 3830-20-Cx 2, 3830-22-C, 3830-25-Cx 2, 3830-29-C, 3830-32-C, 3830-35-Cx 2, 3830-38-C, 3830-44-C
- 3834-ARBR-930
- 3834-ARBR-11152QC

Juego de coronas Sandflex™ bi-metales 19mm-76mm



3834-PROMO-122-76

	€		
1441 g	120,08	1	3834-PROMO-122-76

- 3830-19-C, 3830-20-C, 3830-22-C, 3830-25-C, 3830-27-C, 3830-32-C, 3830-35-C, 3830-38-C, 3830-40-C, 3830-51-C, 3830-64-C, 3830-76-C
- 3834-ARBR-930
- 3834-ARBR-9100

Juego de coronas bi-metales Sandflex® 35 mm-83 mm



3834-SET-72-35/83

	€		
1613 g	125,18	1	3834-SET-72-35/83

- 3830-35-C, 3830-40-C, 3830-44-C, 3830-51-C, 3830-57-C, 3830-68-C, 3830-83-C
- 3834-ARBR-9100
- 3834-DRL

Juego de 4 coronas bi metales



3834-42

	€		
2025 g	149,90	1	3834-SET-42

- 3830-51-VIP, 3830-76-VIP, 3830-86-VIP, 3830-111-VIP
- 3834-ARBR-9100
- 3834-ES

Juego de 11 coronas bi metales



3834-53

	€		
2370 g	218,37	1	3834-SET-53

- 3830-19-VIP, 3830-22-VIP, 3830-25-VIP, 3830-29-VIP, 3830-30-VIP, 3830-35-VIP, 3830-37-VIP, 3830-41-VIP, 3830-52-VIP, 3830-60-VIP, 3830-79-VIP
- 3834-ARBR-930
- 3834-ARBR-9100



Juego de 6 coronas bi-metales



3834-61

	€		
3145 g	183,16	1	3834-SET-61

3830-44-VIP, 3830-51-VIP, 3830-57-VIP, 3830-73-VIP, 3830-86-VIP, 3830-114-VIP	
3834-ARBR-9100	

Juego de 6 coronas bi-metales



3834-62-16/50

	€		
1065 g	117,04	1	3834-SET-62-16/50

3830-16-VIP, 3830-20-VIP, 3830-25-VIP, 3830-32-VIP, 3830-40-VIP, 3830-50-VIP	
3834-ARBR-9100	
3834-ARBR-930	

Juego de 6 coronas bi-metales



3834-65-22/64

	€		
1625 g	151,95	1	3834-SET-65-22/64

3830-22-VIP, 3830-29-VIP, 3830-35-VIP, 3830-44-VIP, 3830-51-VIP, 3830-64-VIP	
3834-ARBR-1130	
3834-ARBR-11152	
3834-DRL	

Juego de 6 coronas bi-metales



3834-62

	€		
1050 g	122,46	1	3834-SET-62

3830-19-VIP, 3830-21-VIP, 3830-22-VIP, 3830-29-VIP, 3830-38-VIP, 3830-48-VIP	
3834-ARBR-930	
3834-ARBR-9100	

Juego de 6 coronas bi-metales



3834-65-16/51

	€		
1465 g	136,54	1	3834-SET-65-16/51

Un cepillo

3830-16-VIP, 3830-20-VIP, 3830-25-VIP, 3830-32-VIP, 3830-40-VIP, 3830-51-VIP	
3834-ARBR-1130	
3834-ARBR-11152	
3834-DRL	

Juego de 7 coronas bi-metales



3834-72

	€		
1080 g	163,24	1	3834-SET-72

3830-19-VIP, 3830-22-VIP, 3830-29-VIP, 3830-35-VIP, 3830-44-VIP, 3830-51-VIP, 3830-64-VIP	
3834-ARBR-930	
3834-ARBR-9100	

Juego de 7 coronas bi-metales



3834-73

	€		
2080 g	202,95	1	3834-SET-73

- 3830-16-VIP, 3830-22-VIP, 3830-51-VIP, 3830-57-VIP, 3830-73-VIP, 3830-76-VIP, 3830-92-VIP
- 3834-ARBR-930
- 3834-ARBR-9100

Juego de 10 coronas bi-metales



3834-SET-77

	€		
3325 g	200,30	1	3834-SET-77

- 3830-16-VIP, 3830-20-VIP, 3830-25-VIP, 3830-32-VIP, 3830-41-VIP, 3830-51-VIP, 3830-73-VIP, 3830-76-VIP, 3830-83-VIP, 3830-86-VIP
- 3834-ARBR-930
- 3834-ARBR-9100
- 3834-DRL

Juego de 8 coronas bi-metales



3834-86

	€		
2540 g	268,80	1	3834-SET-86

- 3830-25-VIP, 3830-32-VIP, 3830-35-VIP, 3830-51-VIP, 3830-54-VIP, 3830-76-VIP, 3830-92-VIP, 3830-114-VIP
- 3834-ARBR-1130
- 3834-ARBR-11152
- 3834-DRLx 2
- 3834-ADP

Juego de 7 coronas bi-metales



3834-73-22/68

	€		
2170 g	151,43	1	3834-SET-73-22/68

- 3830-22-VIP, 3830-29-VIP, 3830-35-VIP, 3830-44-VIP, 3830-51-VIP, 3830-64-VIP, 3830-68-VIP
- 3834-ARBR-1130
- 3834-ARBR-11152
- 3834-DRL

Juego de coronas Sandflex™ bi-metales 25mm-114mm



3834-SET-84-ES

	€		
3600 g	122,61	1	3834-SET-84-ES

- 3830-25-C, 3830-30-C, 3830-35-C, 3830-51-C, 3830-54-C, 3830-76-C, 3830-92-C, 3830-114-C
- 3834-ARBR-930ESM, 3834-ARBR-9100ESM
- 3834-DRL-HSS-ES
- 3834-UPSIZ

Juego de 8 coronas bi-metales



3834-87

	€		
1925 g	187,87	1	3834-SET-87

- 3830-19-VIP, 3830-22-VIP, 3830-29-VIP, 3830-38-VIP, 3830-43-VIP, 3830-48-VIP, 3830-52-VIP, 3830-65-VIP
- 3834-ARBR-930
- 3834-ARBR-9100
- 3834-DRL
- 3834-ES



Juego de 9 coronas bi-metales



3834-92

	€		
1440 g	187,88	1	3834-SET-92

3830-16-VIP, 3830-22-VIP, 3830-25-VIP, 3830-29-VIP, 3830-32-VIP, 3830-41-VIP, 3830-51-VIP, 3830-73-VIP, 3830-83-VIP

3834-ARBR-930

3834-ARBR-9100



Juego de coronas Sandflex™ bi-metales 16mm-83mm



3834-93

	€		
2360 g	163,11	1	3834-SET-93

3830-16-VIP, 3830-20-VIP, 3830-25-VIP, 3830-32-VIP, 3830-40-VIP, 3830-51-VIP, 3830-67-VIP, 3830-76-VIP, 3830-83-VIP

3834-ARBR-930

3834-ARBR-9100QC

3834-DRL



Juego de 9 coronas bi-metales



3834-94

	€		
1815 g	174,23	1	3834-SET-94

3830-16-VIP, 3830-19-VIP, 3830-22-VIP, 3830-25-VIP, 3830-30-VIP, 3830-35-VIP, 3830-41-VIP, 3830-51-VIP, 3830-67-VIP

3834-ARBR-1130

3834-ARBR-11152



Juego de 9 coronas bi-metales



3834-95

	€		
1350 g	184,21	1	3834-SET-95

3830-16-VIP, 3830-19-VIP, 3830-22-VIP, 3830-29-VIP, 3830-35-VIP, 3830-44-VIP, 3830-52-VIP, 3830-57-VIP, 3830-64-VIP

3834-ARBR-1130

3834-ARBR-11152

3834-DRL



Juego de 8 coronas bimetel + soportes



3834-103

	€		
2015 g	144,11	1	3834-SET-103

3830-16-VIP, 3830-19-VIP, 3830-24-VIP, 3830-29-VIP, 3830-38-VIP, 3830-44-VIP, 3830-57-VIP, 3830-67-VIP

3834-ARBR-1130

3834-ARBR-11152

3834-DRL



Juego de 15 coronas bi-metales



3834-SET-152

	€		
3770 g	256,76	1	3834-SET-152

3830-16-VIP, 3830-19-VIP, 3830-22-VIP, 3830-25-VIP, 3830-32-VIP, 3830-35-VIP, 3830-44-VIP, 3830-51-VIP, 3830-57-VIP, 3830-60-VIP, 3830-65-VIP, 3830-68-VIP, 3830-73-VIP, 3830-76-VIP, 3830-83-VIP

3834-ARBR-930

3834-ARBR-9100

3834-DRLx 2



Corona multiconstrucción, madera y ladrillo



3833

	€		
19 mm	13,22	1	3833-19-C
20 mm	13,06	1	3833-20-C
22 mm	13,19	1	3833-22-C
25 mm	13,61	1	3833-25-C
27 mm	14,20	1	3833-27-C
29 mm	15,01	1	3833-29-C
30 mm	14,83	1	3833-30-C
32 mm	15,12	1	3833-32-C
35 mm	16,97	1	3833-35-C
38 mm	16,97	1	3833-38-C
40 mm	17,27	1	3833-40-C
41 mm	17,27	1	3833-41-C
44 mm	20,31	1	3833-44-C
48 mm	20,31	1	3833-48-C
51 mm	20,81	1	3833-51-C
54 mm	22,54	1	3833-54-C
56 mm	23,48	1	3833-56-C
57 mm	23,48	1	3833-57-C
60 mm	23,48	1	3833-60-C
62 mm	23,48	1	3833-62-C
64 mm	23,61	1	3833-64-C
65 mm	23,61	1	3833-65-C
67 mm	23,61	1	3833-67-C
68 mm	23,86	1	3833-68-C
70 mm	24,05	1	3833-70-C
71 mm	24,05	1	3833-71-C
73 mm	24,05	1	3833-73-C
74 mm	24,05	1	3833-74-C
76 mm	24,94	1	3833-76-C
77 mm	27,38	1	3833-77-C
78 mm	27,38	1	3833-78-C
79 mm	27,38	1	3833-79-C
83 mm	27,91	1	3833-83-C
86 mm	28,11	1	3833-86-C
89 mm	28,24	1	3833-89-C
92 mm	29,05	1	3833-92-C
95 mm	29,88	1	3833-95-C
98 mm	30,39	1	3833-98-C
102 mm	32,10	1	3833-102-C
105 mm	32,40	1	3833-105-C
108 mm	32,54	1	3833-108-C
109 mm	35,44	1	3833-109-C
111 mm	32,78	1	3833-111-C
114 mm	35,52	1	3833-114-C
121 mm	35,96	1	3833-121-C
127 mm	37,91	1	3833-127-C
133 mm	38,82	1	3833-133-C
140 mm	39,44	1	3833-140-C
152 mm	42,41	1	3833-152-C
159 mm	48,61	1	3833-159-C
168 mm	54,35	1	3833-168
177 mm	58,23	1	3833-177
210 mm	67,54	1	3833-210
225 mm	70,98	1	3833-225

Juego de coronas multiconstrucción Superior™ de 32-83 mm - 6 Piezas



3833-PROMO-42

g	€		
1489 g	136,04	1	3833-PROMO-42

3833-32-C, 3833-51-C, 3833-76-C, 3833-83-C	
3834-ARBR-9100EL	
3834-UPSIZEL	

Juego de coronas multiconstrucción Superior™ de 19-64 mm - 10 piezas



3833-SET-101

kg	€		
2.75 kg	311,52	1	3833-SET-101

3833-19-C, 3833-22-C, 3833-29-C, 3833-35-C, 3833-44-C, 3833-51-C, 3833-64-C	
3834-ARBR-930EL, 3834-ARBR-9100EL	
3834-DRL-EL	

Juego de coronas multiconstrucción Superior™, 19 mm-86 mm - 14 unidades



3833-SET-201

kg	€		
4.35 kg	353,86	1	3833-SET-201

3833-19-C, 3833-20-C, 3833-25-C, 3833-32-C, 3833-41-C, 3833-51-C, 3833-73-C, 3833-76-C, 3833-83-C, 3833-86-C	
3834-ARBR-930EL, 3834-ARBR-9100EL	
3834-DRL-EL	
3834-UPSIZEL	

Juego de coronas multiconstrucción Superior™ de 19-83 mm - 14 piezas



3833-SET-202

kg	€		
4.1 kg	348,92	1	3833-SET-202

3833-19-C, 3833-20-C, 3833-25-C, 3833-32-C, 3833-41-C, 3833-51-C, 3833-57-C, 3833-60-C, 3833-73-C, 3833-83-C	
3834-ARBR-930EL, 3834-ARBR-9100EL	
3834-DRL-EL	
3834-UPSIZEL	



Juego de coronas multiconstrucción Superior™ de 19-78 mm - 14 piezas



3833-SET-203

kg	€	
4.65 kg	348,92	1 3833-SET-203

- 3833-19-C, 3833-22-C, 3833-54-C, 3833-56-C, 3833-57-C, 3833-62-C, 3833-68-C, 3833-71-C, 3833-74-C, 3833-78-C
- 3834-ARBR-930EL, 3834-ARBR-9100EL
- 3834-DRL-EL
- 3834-UPSIZE

Juego de coronas multiconstrucción Superior™ de 22-67 mm - 9 piezas



3833-SET-205

kg	€	
2.81 kg	263,46	1 3833-SET-205

- 3833-22-C, 3833-35-C, 3833-44-C, 3833-51-C, 3833-67-C
- 3834-ARBR-930EL, 3834-ARBR-9100EL
- 3834-DRL-EL
- 3834-UPSIZE

Juego de coronas multiconstrucción Superior™ de 19-76 mm - 15 piezas



3833-SET-208

kg	€	
3.72 kg	360,52	1 3833-SET-208

- 3833-19-C, 3833-22-C, 3833-25-C, 3833-32-C, 3833-35-C, 3833-38-C, 3833-44-C, 3833-51-C, 3833-57-C, 3833-68-C, 3833-76-C
- 3834-ARBR-930EL, 3834-ARBR-9100EL
- 3834-DRL-EL
- 3834-UPSIZE

Juego de coronas multiconstrucción Superior™ de 32-86 mm - 10 piezas



3833-SET-204

kg	€	
3.88 kg	314,44	1 3833-SET-204

- 3833-32-C, 3833-41-C, 3833-51-C, 3833-73-C, 3833-76-C, 3833-83-C, 3833-86-C
- 3834-ARBR-9100EL
- 3834-DRL-EL
- 3834-UPSIZE

Juego de coronas multiconstrucción Superior™, 19 mm-83 mm - 14 unidades



3833-SET-207

kg	€	
3.90 kg	353,28	1 3833-SET-207

- 3833-19-C, 3833-22-C, 3833-25-C, 3833-35-C, 3833-44-C, 3833-51-C, 3833-64-C, 3833-67-C, 3833-76-C, 3833-83-C
- 3834-ARBR-930EL, 3834-ARBR-9100EL
- 3834-DRL-EL
- 3834-UPSIZE

Juego de coronas multiconstrucción Superior™, 25 mm-114 mm - 12 unidades



3833-SET-301

kg	€	
4.38 kg	334,19	1 3833-SET-301

- 3833-25-C, 3833-32-C, 3833-35-C, 3833-51-C, 3833-54-C, 3833-76-C, 3833-92-C, 3833-114-C
- 3834-ARBR-930EL, 3834-ARBR-9100EL
- 3834-DRL-EL
- 3834-UPSIZE

Juego de coronas multiconstrucción Superior™ de 51-111 mm - 7 piezas



3833-SET-302

	€		
3.51 kg	218,39	1	3833-SET-302

3833-51-C, 3833-76-C, 3833-86-C, 3833-111-C	
3834-ARBR-9100EL	
3834-DRL-EL	
3834-UPSIZ	

Juego de coronas multiconstrucción Superior™ de 35-114 mm - 11 piezas



3833-SET-303

	€		
4.17 kg	280,43	1	3833-SET-303

3833-35-C, 3833-40-C, 3833-51-C, 3833-57-C, 3833-60-C, 3833-74-C, 3833-83-C, 3833-105-C	
3834-ARBR-9100EL	
3834-DRL-EL	
3834-UPSIZ	

Juego de coronas multiconstrucción Superior™, 19 mm-114 mm - 13 unidades



3833-SET-304

	€		
4.20 kg	347,22	1	3833-SET-304

3833-19-C, 3833-25-C, 3833-32-C, 3833-35-C, 3833-51-C, 3833-54-C, 3833-76-C, 3833-92-C, 3833-114-C	
3834-ARBR-930EL, 3834-ARBR-9100EL	
3834-DRL-EL	
3834-UPSIZ	

Corona de sierra, dentado con plaquitas de metal duro



3832

	€		
14 mm	20,00	6	3832-14
16 mm	20,00	6	3832-16
17 mm	20,00	6	3832-17
19 mm	20,00	6	3832-19

	€		
20 mm	20,00	6	3832-20
21 mm	20,00	6	3832-21
22 mm	20,00	6	3832-22
24 mm	20,00	6	3832-24
25 mm	21,09	6	3832-25
27 mm	22,54	6	3832-27
29 mm	22,54	6	3832-29
30 mm	22,54	6	3832-30
32 mm	22,54	6	3832-32
33 mm	22,54	6	3832-33
35 mm	25,08	6	3832-35
37 mm	25,08	6	3832-37
38 mm	25,08	6	3832-38
40 mm	25,08	6	3832-40
41 mm	25,08	6	3832-41
43 mm	25,08	6	3832-43
44 mm	29,09	6	3832-44
46 mm	29,09	6	3832-46
48 mm	29,09	6	3832-48
51 mm	29,09	6	3832-51
52 mm	35,28	4	3832-52
54 mm	35,28	4	3832-54
56 mm	35,28	4	3832-56
57 mm	35,28	4	3832-57
59 mm	35,28	4	3832-59
60 mm	35,28	4	3832-60
64 mm	38,90	4	3832-64
65 mm	38,90	4	3832-65
67 mm	38,90	4	3832-67
68 mm	38,90	4	3832-68
70 mm	38,90	4	3832-70
73 mm	38,90	4	3832-73
76 mm	43,28	4	3832-76
79 mm	43,28	4	3832-79
83 mm	43,28	4	3832-83
86 mm	43,28	4	3832-86
89 mm	43,28	4	3832-89
92 mm	50,17	4	3832-92
95 mm	54,91	4	3832-95
98 mm	58,18	4	3832-98
102 mm	61,07	4	3832-102
105 mm	65,43	4	3832-105
108 mm	76,72	4	3832-108
111 mm	88,73	4	3832-111
114 mm	98,54	4	3832-114
121 mm	109,46	1	3832-121
127 mm	120,37	1	3832-127
133 mm	130,55	1	3832-133
140 mm	141,46	1	3832-140
146 mm	148,71	1	3832-146
152 mm	161,80	1	3832-152



Coronas con puntas de carburo para acero inoxidable, 16-127 mm



3832-C

	€		
16 mm	20,00	1	3832-16-C
19 mm	20,00	1	3832-19-C
20 mm	20,00	1	3832-20-C
22 mm	20,00	1	3832-22-C
24 mm	20,00	1	3832-24-C
25 mm	21,10	1	3832-25-C
29 mm	22,54	1	3832-29-C
30 mm	22,54	1	3832-30-C
32 mm	22,54	1	3832-32-C
35 mm	25,08	1	3832-35-C
38 mm	25,08	1	3832-38-C
41 mm	25,08	1	3832-41-C
44 mm	29,09	1	3832-44-C
46 mm	29,09	1	3832-46-C
48 mm	29,09	1	3832-48-C
51 mm	29,09	1	3832-51-C
54 mm	35,28	1	3832-54-C
57 mm	35,28	1	3832-57-C
60 mm	35,28	1	3832-60-C
64 mm	38,91	1	3832-64-C
73 mm	38,91	1	3832-73-C
76 mm	43,28	1	3832-76-C
83 mm	43,28	1	3832-83-C
86 mm	43,28	1	3832-86-C
92 mm	50,17	1	3832-92-C
102 mm	71,54	1	3832-102-C
114 mm	115,41	1	3832-114-C
127 mm	127,79	1	3832-127-C

Coronas con puntas de carburo para acero inoxidable 25mm - 114mm - 12 piezas



3832-SET-84-ES

g	€		
3600 g	231,75	1	3832-SET-84-ES

3832-25-C, 3832-30-C, 3832-35-C, 3832-51-C, 3832-54-C, 3832-76-C, 3832-92-C, 3832-114-C	
3834-ARBR-9100ESM, 3834-ARBR-930ESM	
3834-DRL-HSS-ES	
3834-UPSIZE	

Juegos de coronas con puntas de carburo para acero inoxidable, 16 mm-114 mm, 20 piezas



3832-SET-164-ES

g	€		
4800 g	383,37	1	3832-SET-164-ES

3832-16-C, 3832-20-C, 3832-25-C, 3832-32-C, 3832-35-C, 3832-41-C, 3832-44-C, 3832-46-C, 3832-51-C, 3832-54-C, 3832-73-C, 3832-76-C, 3832-83-C, 3832-86-C, 3832-92-C, 3832-114-C	
3834-ARBR-9100ESM, 3834-ARBR-930ESM	
3834-DRL-HSS-ES	
3834-UPSIZE	

Juego de coronas mixto 35mm-114mm



3835-SET-64

X	g	€		
10	3870 g	252,92	1	3835-SET-64

3830-35-C, 3830-73-C	
3833-35-C, 3833-73-C, 3833-76-C, 3833-114-C	
3834-ARBR-9100QC-C	
3834-ARBR-9100EL	
3834-DRL-EL	
3834-DRL	

Juego de coronas mixto 12mm-86mm



3835-SET-711

X	g	€		
18	3680 g	265,55	1	3835-SET-711

3830-35-C, 3830-41-C, 3830-51-C, 3830-73-C, 3830-76-C, 3830-83-C, 3830-86-C	
9629-12, 9629-14, 9629-16, 9629-18, 9629-20, 9629-22, 9629-25, 9629-28, 9629-32	
3834-ARBR-9100ESM	
3834-DRL-HSS-ES	

Soporte para coronas con función eyectora



3834-ARBR-EL/ES

		€		
19-30 mm	8.5 mm	41,86	1	3834-ARBR-930EL
32-159 mm	8.5 mm	42,59	1	3834-ARBR-9100EL
16-30 mm	8.5 mm	41,26	1	3834-ARBR-930ESM
32-152 mm	8.5 mm	43,25	1	3834-ARBR-9100ESM

ES: Bimetal y metal duro (Diam. 14-30/Diam 32-210mm) EL: Metal duro (Diam19-30/Diam 32-159)

Broca piloto con punta de carburo para soportes 930EL y 9100EL



3834-DRL-EL

	L	€		
6.35 mm	202 mm	9,40	1	3834-DRL-EL

para soportes 930EL y 9100EL

Accesorios de coronas, broca piloto con eyector corto



3834-DRL-HSS-ES

Ø	L	€	Icon 1	Icon 2
6.35 mm	138 mm	9,01	1	3834-DRL-ES
6.35 mm	138 mm	15,88	1	3834-DRL-HSS-ES

Aumentador para agujeros



3834-upsize

L	€	Icon 1	Icon 2
20.5 mm	4,43	1	3834-UPSIZE

Soporte de corona



3834-ARBR

Ø	L	€	Icon 1	Icon 2
14-30 mm	6.4 mm	11,81	1	3834-ARBR-630
14-30 mm	6.4 mm	12,39	1	3834-ARBR-630-C
14-30 mm	6.4 mm	9,44	1	3834-ARBR-730
14-30 mm	6.4 mm	9,93	1	3834-ARBR-730-C
14-30 mm	8.5 mm	11,81	1	3834-ARBR-930
14-30 mm	8.5 mm	12,39	1	3834-ARBR-930-C
14-30 mm	11.1 mm	13,63	4	3834-ARBR-1130
14-30 mm	11.1 mm	14,31	1	3834-ARBR-1130-C

Soporte para coronas, cambio rápido



3834-ARBR-QC

Ø	L	€	Icon 1	Icon 2
32-152 mm	8.5 mm	24,73	1	3834-ARBR-9100
32-152 mm	8.5 mm	25,98	1	3834-ARBR-9100-C
32-152 mm	8.5 mm	21,09	1	3834-ARBR-9100QC
32-152 mm	8.5 mm	22,38	1	3834-ARBR-9100QC-C
32-210 mm	11.1 mm	24,73	1	3834-ARBR-11152
32-210 mm	11.1 mm	25,98	1	3834-ARBR-11152-C
32-210 mm	11.1 mm	21,09	1	3834-ARBR-11152QC
32-210 mm	11.1 mm	22,16	1	3834-ARBR-11152QC-C
32-210 mm	15.4 mm	24,73	1	3834-ARBR-16152
32-210 mm	15.4 mm	23,11	1	3834-ARBR-16152QC

Soporte de corona



3834-ARBR-SD

Ø	L	€	Icon 1	Icon 2
14-30 mm	SDS+ mm	14,54	1	3834-ARBR-SD30
32-210 mm	SDS+ mm	26,19	1	3834-ARBR-SD152QC

Broca piloto



3834-DRL

Ø	L	€	Icon 1	Icon 2
6.35 mm	81 mm	5,65	1	3834-DRL

Accesorios para coronas, broca piloto de carburo STD



3834-DRL-CT/L

Ø	L	€	Icon 1	Icon 2
6.35 mm	81 mm	16,38	1	3834-DRL-CT
6.35 mm	114 mm	9,14	1	3834-DRL-L

Prolongador



3834-EXT

Ø	L	€	Icon 1	Icon 2
11.1 mm	330 mm	20,80	1	3834-EXT-1
8.5 mm	330 mm	20,80	1	3834-EXT-2

Muelle expulsor



3834-ES

g	€	Icon 1	Icon 2
10 g	2,14	1	3834-ES



Adaptador para soporte



3834-ADP

g	€		
20 g	6,42	1	3834-ADP

Tornillos de repuesto para soportes de corona



3834-SCREWS

g	€		
9 g	2,67	1	3834-M6X29-SET
9 g	1,67	1	3834-M8X5-SET
9 g	1,77	1	3834-M8X6-SET
9 g	1,88	1	3834-M8X10-SET

HOJAS DE SABLE

Hoja de sable bi-metal



3940-M

		€		
100 mm	14	5,39	10	3940-100-14-ST-2P
100 mm	14	13,46	5	3940-100-14-ST-5P
100 mm	14	25,73	1	3940-100-14-ST-10P
100 mm	18	5,39	10	3940-100-18-ST-2P
100 mm	18	13,46	5	3940-100-18-ST-5P
100 mm	18	25,73	1	3940-100-18-ST-10P
150 mm	14	7,08	5	3940-150-14-ST-2P
150 mm	14	17,70	5	3940-150-14-ST-5P

		€		
150 mm	14	33,73	1	3940-150-14-ST-10P
150 mm	14	319,99	1	3940-150-14-ST-100P
150 mm	18	7,08	10	3940-150-18-ST-2P
150 mm	18	17,70	5	3940-150-18-ST-5P
150 mm	18	33,73	1	3940-150-18-ST-10P
150 mm	18	319,99	1	3940-150-18-ST-100P
228 mm	14	9,18	5	3940-228-14-ST-2P
228 mm	14	22,95	5	3940-228-14-ST-5P
228 mm	14	43,32	1	3940-228-14-ST-10P
228 mm	14	412,60	1	3940-228-14-ST-100P
228 mm	18	9,18	10	3940-228-18-ST-2P
228 mm	18	22,95	5	3940-228-18-ST-5P
228 mm	18	43,32	1	3940-228-18-ST-10P
228 mm	18	412,60	1	3940-228-18-ST-100P
300 mm	14	11,31	5	3940-300-14-ST-2P
300 mm	14	28,29	5	3940-300-14-ST-5P
300 mm	14	54,01	1	3940-300-14-ST-10P
300 mm	14	513,43	1	3940-300-14-ST-100P
300 mm	18	11,31	10	3940-300-18-ST-2P
300 mm	18	28,29	5	3940-300-18-ST-5P
300 mm	18	54,01	1	3940-300-18-ST-10P
300 mm	18	512,41	1	3940-300-18-ST-100P

Hoja de sable para metal duro



3940-HM

		€		
150 mm	8/12	7,08	10	3940-150-8/12-ST-2P
150 mm	8/12	17,70	5	3940-150-8/12-ST-5P
150 mm	8/12	33,73	1	3940-150-8/12-ST-10P
150 mm	8/12	319,99	1	3940-150-8/12-ST-100P
228 mm	8/12	9,18	10	3940-228-8/12-ST-2P
228 mm	8/12	22,95	5	3940-228-8/12-ST-5P
228 mm	8/12	43,32	1	3940-228-8/12-ST-10P
228 mm	8/12	412,60	1	3940-228-8/12-ST-100P
150 mm	10	8,01	10	3940-150-10-HST-2P
150 mm	10	20,04	5	3940-150-10-HST-5P
150 mm	10	36,30	1	3940-150-10-HST-10P
150 mm	10	319,99	1	3940-150-10-ST-100P
150 mm	10	7,08	10	3940-150-10-ST-2P
150 mm	10	17,70	5	3940-150-10-ST-5P
150 mm	10	33,73	1	3940-150-10-ST-10P
150 mm	14	8,13	10	3940-150-14-HST-2P
150 mm	14	20,33	5	3940-150-14-HST-5P
150 mm	14	36,70	1	3940-150-14-HST-10P
150 mm	18	8,13	10	3940-150-18-HST-2P
150 mm	18	20,33	5	3940-150-18-HST-5P
150 mm	18	36,70	1	3940-150-18-HST-10P
228 mm	10	9,18	10	3940-228-10-HST-2P
228 mm	10	24,98	5	3940-228-10-HST-5P
228 mm	10	46,04	1	3940-228-10-HST-10P
228 mm	10	625,49	1	3940-228-10-HST-100P
228 mm	10	12,78	10	3940-228-10-ST-2P
228 mm	10	22,95	5	3940-228-10-ST-5P
228 mm	10	43,32	1	3940-228-10-ST-10P
228 mm	10	412,60	1	3940-228-10-ST-100P

		€		
228 mm	14	10,23	10	3940-228-14-HST-2P
228 mm	14	25,60	5	3940-228-14-HST-5P
228 mm	14	47,02	1	3940-228-14-HST-10P
228 mm	18	10,08	10	3940-228-18-HST-2P
228 mm	18	25,19	5	3940-228-18-HST-5P
228 mm	18	50,40	1	3940-228-18-HST-10P
300 mm	10	12,13	10	3940-300-10-HST-2P
300 mm	10	30,35	5	3940-300-10-HST-5P
300 mm	10	54,04	1	3940-300-10-HST-10P
300 mm	14	12,18	10	3940-300-14-HST-2P
300 mm	14	30,43	5	3940-300-14-HST-5P
300 mm	14	54,04	1	3940-300-14-HST-10P
300 mm	18	11,97	10	3940-300-18-HST-2P
300 mm	18	29,96	5	3940-300-18-HST-5P
300 mm	18	52,96	1	3940-300-18-HST-10P

Hojas de sable para metal fino



3940-FM

		€		
100 mm	24	5,39	10	3940-100-24-ST-2P
100 mm	24	13,46	5	3940-100-24-ST-5P
100 mm	24	25,73	1	3940-100-24-ST-10P
150 mm	24	7,08	5	3940-150-24-ST-2P
150 mm	24	17,70	5	3940-150-24-ST-5P
150 mm	24	33,73	1	3940-150-24-ST-10P
150 mm	24	319,99	1	3940-150-24-ST-100P

Hoja de sable bi-metal de precisión



3940-PM

		€		
100 mm	14	5,39	10	3940-100-14-SC-2P
100 mm	14	13,46	5	3940-100-14-SC-5P
100 mm	18	5,39	10	3940-100-18-SC-2P
100 mm	18	13,46	5	3940-100-18-SC-5P
100 mm	24	5,39	10	3940-100-24-SC-2P
100 mm	24	13,46	5	3940-100-24-SC-5P

Hojas de sable con puntas de carburo de tungsteno para materiales de industria pesada



3946-C_HM

Longitud	Teeth	€	Pack	Code
300 mm	8	370,80	1	3946-300-8-HST-10P
150 mm	8	22,25	10	3946-150-8-HST-1P
228 mm	8	30,81	10	3946-228-8-HST-1P
300 mm	8	39,82	10	3946-300-8-HST-1P

10P = 10 piezas

Hojas de sable con puntas de carburo de tungsteno para acero inoxidable



3946-C_SS

Longitud	Teeth	€	Pack	Code
150 mm	10	9,13	10	3946-150-10-HST-1P
228 mm	10	35,38	10	3946-228-10-HST-1P
300 mm	10	47,92	10	3946-300-10-HST-1P

Hojas de sable de grano de diamante para hierro fundido y cerámica



3946-D_CI

Longitud	Grain	€	Pack	Code
100 mm	Grit	9,13	10	3946-100-DG-ST-2P
150 mm	Grit	15,97	10	3946-150-DG-ST-2P

Hoja de sierra para talleres de automoción



3845

Longitud	Teeth	€	Pack	Code
91.5 mm	18	40,61	1	3845-18-10P
91.5 mm	24	40,61	1	3845-24-10P
90 mm	32	40,61	1	3845-32-10P

Hoja de sierra bi-metal, para madera y metal



3940-WM

Longitud	Teeth	€	Pack	Code
150 mm	4/6	9,27	10	3940-150-4/6-SC-2P
150 mm	4/6	17,70	5	3940-150-4/6-SC-5P
150 mm	4/6	33,73	1	3940-150-4/6-SC-10P
150 mm	5/8	9,27	10	3940-150-5/8-SL-2P
150 mm	5/8	17,70	5	3940-150-5/8-SL-5P
150 mm	5/8	33,73	1	3940-150-5/8-SL-10P
150 mm	5/8	319,99	1	3940-150-5/8-SL-100P
150 mm	6	9,27	10	3940-150-6-ST-2P
150 mm	6	17,70	5	3940-150-6-ST-5P
150 mm	6	33,73	1	3940-150-6-ST-10P
228 mm	6	10,73	10	3940-228-6-SL-2P
228 mm	6	22,95	5	3940-228-6-SL-5P
228 mm	6	43,32	1	3940-228-6-SL-10P
300 mm	6	10,73	10	3940-300-6-SL-2P
300 mm	6	28,29	5	3940-300-6-SL-5P
300 mm	6	54,01	1	3940-300-6-SL-10P
300 mm	8/12	10,73	5	3940-300-8/12-SL-2P
300 mm	8/12	28,29	5	3940-300-8/12-SL-5P
300 mm	8/12	54,01	1	3940-300-8/12-SL-10P
300 mm	8/12	502,13	1	3940-300-8/12-SL-100P

Hoja de sable bi-metal, para "fuego y rescate"



3940-FR

Longitud	Teeth	€	Pack	Code
228 mm	10	13,52	10	3940-228-10-DSL-2P
228 mm	10	33,78	5	3940-228-10-DSL-5P
228 mm	10	60,94	1	3940-228-10-DSL-10P
228 mm	10	609,48	1	3940-228-10-DSL-100P

Hoja de sable bi-metal para demolición



3940-D

Longitud	Teeth	€	Pack	Code
150 mm	5/8	10,73	5	3940-150-5/8-DSL-2P
150 mm	5/8	18,54	5	3940-150-5/8-DSL-5P
150 mm	5/8	35,30	1	3940-150-5/8-DSL-10P
228 mm	5/8	10,73	10	3940-228-5/8-DSL-2P
228 mm	5/8	23,87	5	3940-228-5/8-DSL-5P
228 mm	5/8	45,68	1	3940-228-5/8-DSL-10P
300 mm	5/8	11,91	10	3940-300-5/8-DSL-2P
300 mm	5/8	29,73	5	3940-300-5/8-DSL-5P
300 mm	5/8	56,69	1	3940-300-5/8-DSL-10P

Hoja de sable bi-metal, para reparación de pallets



3940-PR

Longitud	Teeth	€	Pack	Code
228 mm	10/14	42,90	1	3940-228-10/14-PR13-10P
228 mm	10/14	31,19	1	3940-228-10/14-PR09-10P
228 mm	10/14	311,77	1	3940-228-10/14-PR09-100P
228 mm	10/14	429,06	1	3940-228-10/14-PR13-100P
228 mm	8/12	396,67	1	3940-228-8/12-PR13-100P
228 mm	10	414,29	1	3940-228-10-PR09-100P



Hojas de sable con puntas de carburo de tungsteno para madera y clavos



3946-C_WM

Longitud	Teeth	€	Pack	Icon
150 mm	6	9,13	10	3946-150-6-DSL-1P
228 mm	6	28,24	10	3946-228-6-DSL-1P
300 mm	6	31,95	10	3946-300-6-DSL-1P

Hojas de sable HSC para madera y plástico



3942-WP

Longitud	Teeth	€	Pack	Icon
228 mm	11	8,74	10	3942-228-11-HSL-2P
228 mm	11	18,44	5	3942-228-11-HSL-5P
228 mm	11	30,84	1	3942-228-11-HSL-10P

Hoja de sable curva para corte medio



3943-C30-JT-M

Longitud	Teeth	€	Pack	Icon
323 mm	13 in	19,12	10	3943-C30-JT-M
373 mm	15 in	21,37	10	3943-C35-JT-M

Hoja de sable, para madera HCS



3942-W

Longitud	Teeth	€	Pack	Icon
228 mm	7	12,05	10	3942-228-7-HSL-2P
228 mm	7	23,46	5	3942-228-7-HSL-5P
228 mm	7	43,32	1	3942-228-7-HSL-10P
300 mm	7	20,17	10	3942-300-7-HSL-2P
300 mm	7	26,64	5	3942-300-7-HSL-5P
300 mm	7	49,61	1	3942-300-7-HSL-10P

Hoja de sable bi-metal, para yeso y planchas



3942-PB

Longitud	Teeth	€	Pack	Icon
150 mm	7	19,24	10	3942-150-7-SL-2P
150 mm	7	19,24	5	3942-150-7-SL-5P
150 mm	7	35,80	1	3942-150-7-SL-10P
228 mm	7	9,31	10	3942-228-7-SL-2P
228 mm	7	23,27	5	3942-228-7-SL-5P
228 mm	7	43,52	1	3942-228-7-SL-10P
300 mm	7	14,54	10	3942-300-7-SL-2P
300 mm	7	27,94	5	3942-300-7-SL-5P
300 mm	7	48,20	1	3942-300-7-SL-10P

Hoja de sable curva corte grueso



3943-C35-JT-C

Longitud	Teeth	€	Pack	Icon
373 mm	15 in	20,70	10	3943-C35-JT-C

Hoja de sable HCS para madera gruesa



3942-CW

Longitud	Teeth	€	Pack	Icon
228 mm	5	12,26	10	3942-228-5-HSL-2P
228 mm	5	25,00	5	3942-228-5-HSL-5P
228 mm	5	46,05	1	3942-228-5-HSL-10P
300 mm	5	15,26	10	3942-300-5-HSL-2P
300 mm	5	29,71	5	3942-300-5-HSL-5P
300 mm	5	51,73	1	3942-300-5-HSL-10P

Hoja de sable curva para corte fino



3943-C30-JT-F

Longitud	Teeth	€	Pack	Icon
323 mm	13 in	19,12	10	3943-C30-JT-F

Hoja de sable recta corte fino



3943-S20-JT-F

Longitud	Teeth	€	Pack	Icon
228 mm	9 in	15,75	10	3943-S20-JT-F

Hoja de sable recta para corte grueso



3943-R28-UT-C-2P



300 mm 12 in 16,87 10 3943-R28-UT-C-2P

Juego de 5 hojas de sable, metal duro y demolición



3940-HDD-SET-5P



5 222 g 33,52 5 3940-HDD-SET-5P

3940-150-5/8-DSL, 3940-228-5/8-DSL, 3940-228-10-DSL, 3940-150-14-HST, 3940-228-14-HST, 3940-150-5/8-DSL, 3940-228-5/8-DSL, 3940-228-10-DSL, 3940-150-14-HST, 3940-228-14-HST

Juego de hojas de sable para madera y metal (12 piezas)



3940-MIX-SET-12P

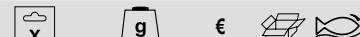

12 480 g 54,04 6 3940-MIX-SET-12P

Juego de 5 hojas de sierra, para metal



3940-METAL-SET-5P

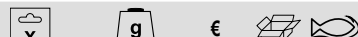

5 125 g 22,00 5 3940-METAL-SET-5P

3940-150-14-ST, 3940-150-18-ST, 3940-150-24-ST, 3940-228-18-ST, 3940-228-14-ST, 3940-150-14-ST, 3940-150-18-ST, 3940-150-24-ST, 3940-228-18-ST, 3940-228-14-ST

Juego de hojas de sable, para metal y madera



3940-MIX-SET-5P

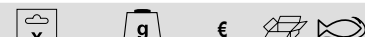

5 150 g 25,13 5 3940-MIX-SET-5P

3940-100-24-SC, 3940-150-18-ST, 3940-150-14-ST, 3940-228-6-SL, 3942-228-7-HSL, 3940-100-24-SC, 3940-150-18-ST, 3940-150-14-ST, 3940-228-6-SL, 3942-228-7-HSL

Juego de 5 hojas de sable, para madera



3942-WOOD-SET-5P

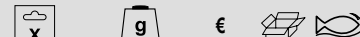

5 191 g 29,33 5 3942-WOOD-SET-5P

3940-228-6-SL, 3942-228-11-HSL, 2x 3942-228-7-HSL, 3942-150-7-SL, 3940-228-6-SL, 3942-228-11-HSL, 3942-228-7-HSL, 3942-228-7-HSL, 3942-150-7-SL

Juego de hojas de sable bimetálica Sandflex® para metales (12 piezas)



3940-METAL-SET-12P



12 460 g 52,80 6 3940-METAL-SET-12P

Juego de 10 hojas de sierra, para metal y madera



3940-MIX-SET-10P

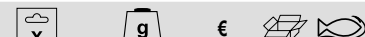

10 245 g 45,04 4 3940-MIX-SET-10P

3940-100-24-SC, 3940-100-18-SC, 3940-150-24-ST, 3940-150-18-ST, 3940-150-14-ST, 3940-150-10-ST, 3940-228-6-SL, 3942-228-11-HSL, 3942-228-7-HSL, 3942-150-7-SL, 3940-100-24-SC, 3940-100-18-SC, 3940-150-24-ST, 3940-150-18-ST, 3940-150-14-ST, 3940-150-10-ST, 3940-228-6-SL, 3940-228-11-HSL, 3942-228-7-HSL, 3942-150-7-SL

Juego de hojas de sable para madera (12 piezas)



3942-WOOD-SET-12P



12 525 g 70,40 6 3942-WOOD-SET-12P



Hoja de acero inoxidable para corte de carne y hielo



3944

L	T	€	Paquete	Artículo
300 mm	4	11,43	10	3944-300-3-MEAT-1P

Hojas de sable con punta de carburo para materiales de piedra



3946-CT

L	T	€	Paquete	Artículo
150 mm	6	24,50	5	3946-150-6-SL-1P
228 mm	3	23,87	5	3946-228-3-ST-1P

Hojas de sable con dientes de carburo de tungsteno para ladrillos, arlita y hormigón celular.



3946-C_B

L	T	€	Paquete	Artículo
300 mm	2	34,23	10	3946-300-2-CB-1P
457 mm	2	45,64	10	3946-457-2-CB-1P

HOJAS DE CALAR

Anclaje europeo, acero al carbono



91-M

L	T	€	Paquete	Artículo
100 mm	15/23	8,50	1	91-3PM-5P
100 mm	8	13,03	1	91-433-5P
77 mm	36	7,21	1	91-502-5P

L	T	€	Paquete	Artículo
77 mm	21	8,84	1	91-512-5P
77 mm	21	35,13	1	91-512-25P
77 mm	21	7,95	1	91-517-5P
77 mm	13	7,46	1	91-522-5P
132 mm	25	9,61	1	91-611-5P
77 mm	21	7,77	1	91-612-5P
77 mm	13	9,02	1	91-622-5P
132 mm	14	16,53	1	91-7V1-5P

Anclaje europeo, acero al carbono



91-WM

L	T	€	Paquete	Artículo
132 mm	10/14	13,30	1	91-4PWM-5P
100 mm	10/14	13,52	1	91-623-5P

Anclaje europeo, acero al carbono



91-W

L	T	€	Paquete	Artículo
117 mm	10	10,51	1	91-2PW-5P
132 mm	8	17,87	1	91-434-5P
105 mm	6	19,10	1	91-444-5P
100 mm	8	4,41	1	91-023-5P
77 mm	12	5,79	1	91-027-5P
100 mm	6	6,10	1	91-143-5P
100 mm	6	27,85	1	91-143-25P
100 mm	6	111,52	1	91-143-100P
100 mm	6	7,15	1	91-148-5P
100 mm	10	6,42	1	91-223-5P
100 mm	10	8,99	1	91-226-5P
132 mm	6	8,68	1	91-233-5P
100 mm	6	7,21	1	91-243-5P
77 mm	19	13,52	1	91-412-5P
100 mm	6	18,67	1	91-443-5P

Juego de 10 hojas de calar para metal



91-METAL-10P

Paquete	€	Paquete	Artículo
10	18,82	1	91-METAL-10P

x3 91-512 (T118A), x3 91-522 (T118B), x1 91-433 (T127DF), x1 91-502 (T118G), x2 91-4PWM (T111HF)

Juego de 10 hojas de calar para madera



91-WOOD-10P

Paquete	€	Paquete	Artículo
10	16,42	1	91-WOOD-10P

x4 91-143 (T144D), x2 91-223 (T101B), x2 91-023 (T111C), x1 91-148 (T244D), x1 91-226 (T101BR)

Juego mixto de 10 hojas de calar



91-MIXED-10P

Paquete	€	Paquete	Artículo
10	18,02	1	91-MIXED-10P

x3 91-143 (T144D), x1 91-223 (T101B), x1 91-148 (T244D), x2 91-512 (T118A), x2 91-522 (T118B), x1 91-623 (T111HF)

ACCESORIOS MULTIHERRAMIENTAS

Hojas multi herramientas con forma estándar para cortar madera



92-S_W

			€		
1		35 x 50 x 97 mm	18,26	70	92-133-1P
3		35 x 50 x 97 mm	47,92	46	92-133-3P

Hojas multi herramientas con forma estándar para cortes de precisión en madera



92-P_W

			€		
1		30 x 50 x 97 mm	20,54	70	92-205-1P
3		30 x 50 x 97 mm	58,53	46	92-205-3P
1		65 x 50 x 97 mm	17,12	70	92-229-1P

Hojas multiherramientas con forma estándar curvada para cortar madera



92-C_W

			€		
1		65 x 50 x 97 mm	15,40	70	92-225-1P

Hoja multi herramientas con forma estándar para cortes universales en madera con clavos



92-U_WN

			€		
1		35 x 50 x 97 mm	17,12	70	92-160-1P
3		35 x 50 x 97 mm	52,49	46	92-160-3P

Hoja multiherramientas duradera con forma estándar para cortar madera con clavos



92-LF_WN

			€		
1		50 x 50 x 97 mm	18,26	70	92-221-1P
1		65 x 50 x 97 mm	17,12	70	92-228-1P

Cuchilla multi herramientas con forma estándar para cortar madera con metal



92-U_WM

			€		
1		28 x 55 x 100 mm	18,83	70	92-222-1P
3		28 x 55 x 100 mm	53,66	46	92-222-3P
1		44 x 55 x 100 mm	19,40	70	92-223-1P
3		44 x 55 x 100 mm	51,91	46	92-223-3P

Hoja multiherramientas con puntas de carburo y revestimiento de TiN para cortar metales



92-C_M

			€		
1		35 x 42 x 82 mm	29,67	70	92-236-1P

Hojas multiherramientas con forma estándar para corte fino en metal



92-FM

			€		
1		30 x 50 x 97 mm	14,84	70	92-157-1P

Hojas multi herramientas en segmentos para cortar metal



92-M_S

			€		
1		85 mm	26,15	90	92-106-1P



Hojas multi herramientas en segmentos para cortar madera



92-SP

1 85 mm 23,61 90 92-113-1P

Hojas multiherramientas en segmentos para ranurados y trabajos de repaso



92-CG_S

1 75 mm 46,52 90 92-118-1P

Cuchilla multi herramienta con forma estándar para materiales blandos



92-MFK

1 41 x 42 x 87 mm 25,36 70 92-251-1P

Hojas multi herramientas con forma circular para cortar metal



92-M_R

115 85 mm 46,52 90 92-174-1P

Hojas multiherramientas en segmentos para mármol y epoxi



92-DG_S

1 90 mm 78,90 50 92-166-1P

Hojas multi herramientas con forma estándar para rasqueta



92-SC

1 52 x 38 x 83 mm 10,56 90 92-165-1P
1 50 x 38 x 83 mm 19,69 90 92-226-1P

Juego de hojas multi herramientas con forma estándar para cortar madera y metal (8 piezas)



92-Universal_WM_Set

8 32 x 160 x 195 mm 119,92 34 92-WM-SET-8P

92-222-1Px 2, 92-223-1Px 2

92-228-1Px 2

92-160-1Px 2

Hojas multi herramientas con forma triangular para trabajos de raspado y repaso



92-CR_T

1 80 mm 32,38 90 92-001-1P

Hojas de corte multi herramienta con forma de champiñón



92-CM

1 70 x 30 x 75 mm 30,64 90 92-245-1P

Almohadillas de lijado multiherramientas con forma triangular



92-Sanding

X	Δ	€		
1	80 mm	29,67	20	92-136-1P
5	82 mm	3,99	10	92-136-G40-5P
5	82 mm	3,99	10	92-136-G80-5P
5	82 mm	3,99	10	92-136-G120-5P
5	82 mm	3,99	10	92-136-G240-5P
1	93 mm	12,29	50	92-137-1P
5	94 mm	3,99	10	92-137-G40-5P
5	94 mm	3,99	10	92-137-G80-5P
5	94 mm	3,99	10	92-137-G120-5P
5	94 mm	3,99	10	92-137-G240-5P

HOJAS PARA SIERRAS CIRCULARES

Sierra circular para madera media



8501-C

Ø	Curve	€		
136 mm	24	22,18	1	8501-136-10-24C
136 mm	24	24,65	1	8501-136-20-24C
150 mm	24	27,11	1	8501-150-10-24C
160 mm	24	28,35	1	8501-160-20-24C
165 mm	24	28,35	1	8501-165-20-24C
184 mm	24	30,81	1	8501-184-20-24C
190 mm	24	36,97	1	8501-190-30-24C

Sierra circular para madera media



8501-P/T

Ø	Curve	€		
125 mm	16	25,52	1	8501-2
130 mm	16	24,84	1	8501-3
140 mm	16	25,64	1	8501-4
140 mm	24	26,89	1	8501-4F
140 mm	30	28,29	1	8501-4XF
150 mm	18	29,75	1	8501-5
150 mm	30	31,99	1	8501-5F
160 mm	18	29,47	1	8501-7
160 mm	30	31,53	1	8501-7F
170 mm	18	31,99	1	8501-10
170 mm	30	34,26	1	8501-10F
180 mm	20	33,48	1	8501-12
180 mm	40	39,39	1	8501-12F
184 mm	24	36,49	1	8501-13
184 mm	40	38,83	1	8501-13F
184 mm	24	32,03	1	8501-184-16-24
184 mm	40	33,88	1	8501-184-16-40
190 mm	20	38,47	1	8501-15
190 mm	40	42,09	1	8501-15F
190 mm	60	40,05	1	8501-190-30-60XF
200 mm	20	46,93	1	8501-16
200 mm	40	51,30	1	8501-16F
210 mm	20	46,67	1	8501-17
210 mm	40	53,07	1	8501-17F
210 mm	60	46,83	1	8501-210-30-60XF
230 mm	20	47,48	1	8501-22
230 mm	40	54,70	1	8501-22F
230 mm	60	51,75	1	8501-230-30-60XF
235 mm	30	48,02	1	8501-23
235 mm	40	55,39	1	8501-23F
235 mm	60	52,98	1	8501-235-30-60XF
250 mm	24	60,97	1	8501-28
250 mm	40	63,51	1	8501-28F
250 mm	60	70,27	1	8501-28XF

Sierra circular para madera



8501-P

Ø	Curve	€		
160 mm	48	28,35	1	8501-160-20-48XF
165 mm	48	29,58	1	8501-165-20-48XF

Sierra circular para madera



8501-M

Ø	Curve	€		
210 mm	48	78,86	1	8501-210-30-48SW
216 mm	24	49,45	1	8501-16SW
216 mm	48	52,72	1	8501-18SW
216 mm	60	54,70	1	8501-216-60SW
250 mm	60	70,20	1	8501-28SW
260 mm	24	72,48	1	8501-260-24SW
260 mm	40	67,78	1	8501-260-40SW
260 mm	60	71,48	1	8501-260-60SW
300 mm	60	91,42	1	8501-30SW
305 mm	40	41,78	1	8501-305-30-40SW
305 mm	60	45,60	1	8501-305-30-60SW

Sierra circular para madera



8501-S

Ø	Curve	€		
300 mm	30	80,24	1	8501-30
300 mm	40	82,59	1	8501-30F
300 mm	60	91,15	1	8501-30XF
315 mm	30	82,27	1	8501-31
315 mm	40	90,79	1	8501-31F
400 mm	40	108,31	1	8501-40



Sierra circular para aluminio y plástico



8501-AP

Ø	Longitud	€	Paquetes	Aplicaciones
210 mm	48	52,94	1	8501-17S
216 mm	48	56,21	1	8501-18S
250 mm	80	83,97	1	8501-28S
260 mm	80	80,10	1	8501-260-30-80S
300 mm	96	108,12	1	8501-30S
305 mm	96	53,73	1	8501-305-30-96S

DISCOS ABRASIVOS

Discos abrasivos de corte de alto rendimiento para uso general



391-T41_IM

Ø	€	Paquetes	Aplicaciones
	2,56	50	3911-2301922XDT
	2,44	50	3911-2302522XDT
	1,12	10	3911-751010XTM
115x1.6 mm	0,93	50	3911-115-T41-IM
115x1.0 mm	0,93	50	3911-115T41-IM
125x1.6 mm	1,13	50	3911-125-T41-IM
180x2.0 mm	2,16	50	3911-180-T41-IM
230x2.5 mm	3,08	50	3911-230-T41-IM
115x1.0 mm	0,82	25	3912-115-T41-IM
125x1.0 mm	0,88	25	3912-125-T41-IM
125x1.0 mm	0,98	25	3911-125T41-IM
180x1.6 mm	1,69	50	3911-180T41-IM
230x1.9 mm	2,33	50	3911-230T41-IM
230x3.0 mm	2,78	50	3911-230T41-IM
115x1 mm	12,01	10	3911-115-IM-10P
125x1 mm	12,50	10	3911-125-IM-10P

Discos de corte abrasivos de alto rendimiento para aluminio



391-T41_ALU

Ø	Longitud	€	Paquetes	Aplicaciones
115 mm	22.23 mm	0,98	25	3911-115-T41-AL
125 mm	22.23 mm	0,98	25	3911-125-T41-AL

Discos abrasivos de corte de alto rendimiento para inox.



391-T41-I

Ø	€	Paquetes	Aplicaciones
115x1.0 mm	0,98	25	3911-115-T41-I
125x1.0 mm	1,13	25	3911-125-T41-I
150x1.0 mm	2,05	50	3911-150-T41-I
180x1.6 mm	2,42	50	3911-180-T41-I
230x1.9 mm	3,08	50	3911-230-T41-I

Discos de corte abrasivos de alto rendimiento para acero inoxidable y metal



391-T41_CS

Ø	Longitud	€	Paquetes	Aplicaciones
356 mm	25.4 mm	5,67	35	3911-350-X2TM
400 mm	25.4 mm	11,69	15	3911-400-F2TM
400 mm	25.4 mm	12,25	15	3911-400-X2TM

Discos abrasivos de corte de alto rendimiento para metal



391-T42_M

Ø	€	Paquetes	Aplicaciones
115x2.5 mm	0,88	25	3911-115-T42-M
125x2.5 mm	0,98	25	3911-125-T42-M
150x2.5 mm	1,65	25	3911-150-T42-M
180x3.2 mm	2,16	25	3911-180-T42-M
230x3.2 mm	3,08	50	3911-230-T42-M

Discos abrasivos de corte de alto rendimiento para construcción



391-T42_ST

Ø	€	Paquetes	Aplicaciones
115x3.2 mm	1,03	25	3912-115-T42-ST
125x3.2 mm	1,24	25	3912-125-T42-ST
180x3.2 mm	1,34	25	3912-180-T42-ST
230x3.2 mm	2,16	50	3912-230-T42-ST

Discos abrasivos de alto rendimiento para uso general



392-T27_IM

Ø	€	Paquetes	Aplicaciones
115x6.4 mm	1,39	25	3921-115-T27-IM
125x6.4 mm	1,75	25	3921-125-T27-IM
150x6.4 mm	2,42	25	3921-150-T27-IM
180x6.5 mm	2,78	25	3921-180-T27-IM
230x6.5 mm	4,22	25	3921-230-T27-IM

Discos abrasivos flexibles para desbaste de inox. y metal



392-FLAP_C

Ø	€	Icon	Icon
115 mm	3,30	20	3926-115IM-C40
115 mm	3,30	20	3926-115IM-C60
115 mm	3,30	20	3926-115IM-C80
115 mm	3,30	20	3926-115IM-C120
125 mm	3,91	20	3926-125IM-C40
125 mm	3,91	20	3926-125IM-C60
125 mm	3,91	20	3926-125IM-C80
125 mm	3,91	20	3926-125IM-C120

Discos abrasivos flexibles para inox. y metal



392-FLAP_P

Ø	€	Icon	Icon
115 mm	2,27	20	3927-115IM-P40
115 mm	2,27	20	3927-115IM-P60
115 mm	2,27	20	3927-115IM-P80
115 mm	2,27	20	3927-115IM-P120
125 mm	2,63	20	3927-125IM-P40
125 mm	2,63	20	3927-125IM-P60
125 mm	2,63	20	3927-125IM-P80
125 mm	2,63	20	3927-125IM-P120
125 mm	8,06	12	3927-125-40-3P
125 mm	8,06	12	3927-125-60-3P
125 mm	8,06	12	3927-125-80-3P
125 mm	8,06	12	3927-125-120-3P

Discos abrasivos de diamante para corte de cerámica y azulejos



391-DIAM_C

Ø	€	Icon	Icon
115 mm	17,00	100	3916-115-10P-CE
125 mm	21,01	100	3916-125-10P-CE
115 mm	6,49	100	3917-115-7S-C
125 mm	8,14	100	3917-125-7S-C

Discos abrasivos de diamante para uso general de corte en construcción



391-DIAM_U

Ø	€	Icon	Icon
115 mm	11,64	100	3916-115-10S-UE
125 mm	14,32	100	3916-125-10S-UE
150 mm	17,05	50	3916-150-10S-UE
180 mm	18,08	50	3916-180-10S-UE
230 mm	25,39	25	3916-230-10S-UE
115 mm	6,28	100	3917-115-7S-U
125 mm	8,34	100	3917-125-7S-U
230 mm	18,54	25	3917-230-7S-U

Discos abrasivos de Diamante para hormigón armado



391-DIAM_RC

Ø	€	Icon	Icon
230 mm	45,01	25	3916-230-10L-RC

SIERRAS DE CINTA

Hojas de sierra



3857 Easy-Cut Portaband

Icon	Icon	€	Icon	Icon
S	EZ	27,79	1	3857-13-0-6-EZ-S-3P690
S	EZ	27,79	1	3857-13-0-6-EZ-S-3P730
S	EZ	27,79	1	3857-13-0-6-EZ-S-3P835
S	EZ	27,79	1	3857-13-0-6-EZ-S-3P900
M	EZ	27,79	1	3857-13-0-6-EZ-M-3P690
M	EZ	27,79	1	3857-13-0-6-EZ-M-3P730
M	EZ	27,79	1	3857-13-0-6-EZ-M-3P835
M	EZ	27,79	1	3857-13-0-6-EZ-M-3P900
M	EZ	27,79	1	3857-13-0-6-EZ-M-3P1140



LIMAS ROTATIVAS DE CARBURO

Limas rotativas de Carburo de Tungsteno, cilíndrica



A

Ø	Grain	€	Icons
3 mm	Medium	14,52	1 A0313M03
3 mm	Medium	17,63	1 A0313M03E
3 mm	Medium	15,12	1 A0313M03X
3 mm	Medium	17,65	1 A0313M03XE
3 mm	Medium	22,62	1 A0313M03XE-60
3 mm	Medium	22,97	1 A0313M03XE-80
6.3 mm	Medium	26,41	1 A0613M03X
6 mm	Medium	25,21	1 A0616M06
6 mm	Medium	28,83	1 A0616M06E
6 mm	Medium	27,65	1 A0616M06X
6 mm	Medium	28,83	1 A0616M06XE
8 mm	Medium	36,89	1 A0820M06
8 mm	Medium	42,74	1 A0820M06E
8 mm	Medium	39,31	1 A0820M06X
8 mm	Medium	45,10	1 A0820M06XE
10 mm	Medium	42,34	1 A1020M06
10 mm	Medium	48,79	1 A1020M06E
9.6 mm	Medium	44,35	1 A1020M06X
9.6 mm	Medium	48,79	1 A1020M06XE
12 mm	Medium	53,04	1 A1225M06
12.7 mm	Medium	61,08	1 A1225M06E
12 mm	Medium	59,14	1 A1225M06X
12.7 mm	Medium	55,95	1 A1225M08
12.7 mm	Medium	61,08	1 A1225M08E
12.7 mm	Medium	56,05	1 A1225M08X
12.7 mm	Medium	64,32	1 A1225M08XE
16 mm	Medium	66,52	1 A1625M06
16 mm	Medium	69,95	1 A1625M06X
16 mm	Medium	80,46	1 A1625M06XE
16 mm	Medium	66,52	1 A1625M08
16 mm	Medium	80,45	1 A1625M08E
16 mm	Medium	69,95	1 A1625M08X
16 mm	Medium	76,42	1 A1625M08XE

F=Fino, M=Entrefino, C=Basto, EC= Extra Basto

Limas rotativas de Carburo de Tungsteno, Cilíndrica punta redonda



C

Ø	Grain	€	Icons
3 mm	Medium	14,52	1 C0313M03
3 mm	Medium	15,12	1 C0313M03X
6.3 mm	Medium	30,84	1 C0616M03X
6 mm	Medium	27,83	1 C0616M06
6 mm	Medium	29,23	1 C0616M06X
8 mm	Medium	39,92	1 C0820M06
8 mm	Medium	41,93	1 C0820M06X

Ø	Grain	€	Icons
9.6 mm	Medium	40,73	1 C1020M06
10 mm	Medium	42,74	1 C1020M06X
12 mm	Medium	60,49	1 C1225M06
12 mm	Medium	67,43	1 C1225M06X
12.7 mm	Medium	63,92	1 C1225M08X
16 mm	Medium	74,00	1 C1625M06
16 mm	Medium	77,63	1 C1625M06X
16 mm	Medium	74,00	1 C1625M08
16 mm	Medium	77,63	1 C1625M08X

F=Fino, M=Entrefino, C=Basto, EC= Extra Basto

Limas rotativas de Carburo de Tungsteno



D

Ø	Grain	€	Icons
3 mm	Medium	18,46	1 D0303M03
3 mm	Medium	19,32	1 D0303M03X
6.3 mm	Medium	29,71	1 D0605M03X
6 mm	Medium	28,23	1 D0606M06
6 mm	Medium	29,71	1 D0606M06X
8 mm	Medium	29,08	1 D0807M06
8 mm	Medium	30,56	1 D0807M06X
9.6 mm	Medium	30,14	1 D1009M06
9.6 mm	Medium	31,61	1 D1009M06X
12.7 mm	Medium	42,02	1 D1211M06
12.7 mm	Medium	44,15	1 D1211M06X
16 mm	Medium	62,24	1 D1614M06
16 mm	Medium	61,97	1 D1614M06X
16 mm	Medium	59,00	1 D1614M08
16 mm	Medium	61,99	1 D1614M08X

F=Fino, M=Entrefino, C=Basto, EC= Extra Basto

Limas rotativas de Carburo de Tungsteno, ovalada



E

Ø	Grain	€	Icons
3 mm	Medium	23,77	1 E0308M03
3 mm	Medium	25,05	1 E0308M03X
6 mm	Medium	40,74	1 E0614M06
8 mm	Medium	46,16	1 E0816M06
8 mm	Medium	45,97	1 E0816M06X
9.6 mm	Medium	48,79	1 E1018M06
9.6 mm	Medium	51,21	1 E1018M06X
12.7 mm	Medium	56,05	1 E1222M06
12.7 mm	Medium	58,88	1 E1222M06X
12.7 mm	Medium	59,01	1 E1222M08
12.7 mm	Medium	61,99	1 E1222M08X
16 mm	Medium	90,33	1 E1625M06

Ø	Grain	€	Icons
16 mm	Medium	99,35	1 E1625M06X
16 mm	Medium	90,33	1 E1625M08
16 mm	Medium	94,76	1 E1625M08X

F=Fino, M=Entrefino, C=Basto, EC=Extra Basto

Limas rotativas de Carburo de Tungsteno, Ojival punta redonda



F

Ø	Grain	€	Icons
3 mm	Medium	14,52	1 F0313M03
3 mm	Medium	15,32	1 F0313M03X
6.3 mm	Medium	31,92	1 F0613M03X
6 mm	Medium	35,69	1 F0618M06
6 mm	Medium	37,51	1 F0618M06X
8 mm	Medium	46,97	1 F0820M06
8 mm	Medium	49,40	1 F0820M06X
9.6 mm	Medium	45,77	1 F1020M06
9.6 mm	Medium	47,99	1 F1020M06X
12.7 mm	Medium	58,07	1 F1225M06
12.7 mm	Medium	60,89	1 F1225M06X
12.7 mm	Medium	58,07	1 F1225M08
12.7 mm	Medium	60,89	1 F1225M08X
16 mm	Medium	88,91	1 F1625M06
16 mm	Medium	88,51	1 F1625M06X
16 mm	Medium	88,73	1 F1625M08

F=Fino, M=Entrefino, C=Basto, EC= Extra Basto

Limas rotativas de Carburo de Tungsteno



G

Ø	Grain	€	Icons
3 mm	Medium	14,52	1 G0313M03
3 mm	Medium	15,12	1 G0313M03X
6.3 mm	Medium	30,25	1 G0613M03X
6 mm	Medium	31,48	1 G0618M06
6 mm	Medium	31,26	1 G0618M06X
8 mm	Medium	40,32	1 G0820M06
8 mm	Medium	42,34	1 G0820M06X
9.6 mm	Medium	48,79	1 G1020M06
9.6 mm	Medium	51,21	1 G1020M06X
12.7 mm	Medium	57,06	1 G1225M06
12.7 mm	Medium	59,88	1 G1225M06X
12 mm	Medium	60,07	1 G1225M08
12 mm	Medium	59,88	1 G1225M08X
16 mm	Medium	77,22	1 G1625M06
16 mm	Medium	81,05	1 G1625M06X
16 mm	Medium	77,22	1 G1625M08
16 mm	Medium	81,05	1 G1625M08X

F=Fino, M=Entrefino, C=Basto, EC= Extra Basto *Fabricación bajo pedido

Limas rotativas de Carburo de Tungsteno



H

Ø	Grain	€	Box	Box
6 mm	Medium	31,84	1	H0613M03X
10 mm	Medium	56,24	1	H1025M06
10 mm	Medium	59,00	1	H1025M06X
12.7 mm	Medium	69,40	1	H1232M06
12.7 mm	Medium	72,80	1	H1232M06X
16 mm	Medium	90,84	1	H1635M06X
16 mm	Medium	86,60	1	H1635M06
16 mm	Medium	86,60	1	H1635M08
16 mm	Medium	95,83	1	H1635M08X

F=Fino, M=Entrefino, C=Basto, EC= Extra Basto

Limas rotativas de Carburo de Tungsteno, Cónica 60°



J

Ø	Grain	€	Box	Box
6 mm	Medium	36,49	1	J0604M06
9.6 mm	Medium	40,74	1	J1010M06
12.7 mm	Medium	48,13	1	J1212M06
16 mm	Medium	70,52	1	J1616M06
16 mm	Medium	66,85	1	J1616M08

F=Fino, M=Entrefino, C=Basto, EC= Extra Basto *Fabricación bajo pedido

Limas rotativas de Carburo de Tungsteno, Cónica 90°



K

Ø	Grain	€	Box	Box
6 mm	Medium	36,49	1	K0602M06
9.6 mm	Medium	42,99	1	K1008M06
12.7 mm	Medium	45,62	1	K1210M06
16 mm	Medium	62,69	1	K1612M06
16 mm	Medium	59,43	1	K1612M08

F=Fino, M=Entrefino, C=Basto, EC= Extra Basto

Limas rotativas de Carburo de Tungsteno, Cónica punta redonda



L

Ø	Grain	€	Box	Box
10 mm	Medium	58,22	1	L1020M06
10 mm	Medium	61,14	1	L1020M06X
12.7 mm	Medium	64,73	1	L1225M06
12.7 mm	Medium	71,65	1	L1225M06X
12.7 mm	Medium	73,22	1	L1230M06
12.7 mm	Medium	72,80	1	L1230M06X
16 mm	Medium	76,59	1	L1630M06
16 mm	Medium	80,38	1	L1630M06X
16 mm	Medium	76,59	1	L1630M08
16 mm	Medium	80,38	1	L1630M08X

F=Fino, M=Entrefino, C=Basto, EC= Extra Basto

Limas rotativas de Carburo de Tungsteno, Cónica con punta



M

Ø	Grain	€	Box	Box
3 mm	Medium	19,78	1	M0310M03
3 mm	Medium	19,76	1	M0310M03X
6.3 mm	Medium	30,25	1	M0613M03X
6 mm	Medium	34,67	1	M0618M06
6 mm	Medium	34,48	1	M0618M06X
9.5 mm	Medium	41,91	1	M1022M06
9.5 mm	Medium	41,74	1	M1022M06X
12.7 mm	Medium	53,82	1	M1227M06
12.7 mm	Medium	53,63	1	M1227M06X
12.7 mm	Medium	53,71	1	M1227M08
16 mm	Medium	88,91	1	M1630M06
16 mm	Medium	88,51	1	M1630M06X
16 mm	Medium	88,91	1	M1630M08
16 mm	Medium	88,51	1	M1630M08X

F=Fino, M=Entrefino, C=Basto, EC=Extra Basto

Limas rotativas de Carburo de Tungsteno, Cónica invertida



N

Ø	Grain	€	Box	Box
3 mm	Medium	19,03	1	N0306M03
3 mm	Medium	20,81	1	N0306M03E
6 mm	Medium	29,71	1	N0607M06
12.7 mm	Medium	47,47	1	N1213M06
12.7 mm	Medium	47,26	1	N1213M06X
16 mm	Medium	62,02	1	N1613M06
16 mm	Medium	61,75	1	N1613M06X
16 mm	Medium	62,02	1	N1613M08

F=Fino, M=Entrefino, C=Basto, EC= Extra Basto

Limas rotativas de Carburo de Tungsteno



A-AL

Ø	Grain	€	Box	Box
6 mm	AL	34,68	1	A0616AL06E
12.7 mm	AL	63,71	1	A1225AL06E
12.7 mm	AL	63,71	1	A1225AL08E
16 mm	AL	105,39	1	A1625AL08XE

Limas rotativas de Carburo de Tungsteno



C-AL

Ø	Grain	€	Box	Box
6 mm	AL	33,46	1	C0616AL06
12.7 mm	AL	63,92	1	C1225AL06



Limas rotativas de Carburo de Tungsteno



D-AL

		€		
12.7 mm	AL	50,52	1	D1211AL06
12.7 mm	AL	50,52	1	D1211AL08

Limas rotativas de Carburo de Tungsteno



A/G

		€		
6 mm	TR	32,07	1	A0625M06X

Limas rotativas esféricas de carburo de tungsteno para acero de alta aleación



D-S

		€		
6 mm	Steel	20,17	5	D0606S06
9.6 mm	Steel	24,24	5	D1010S06
12.7 mm	Steel	32,70	5	D1212S06

Limas rotativas de Carburo de Tungsteno



F-AL

		€		
6 mm	AL	42,74	1	F0618AL06
12.7 mm	AL	58,07	1	F1225AL06
12.7 mm	AL	58,07	1	F1225AL08

Limas rotativas cilíndricas de carburo de tungsteno para acero de alta aleación



A-S

		€		
6 mm	Steel	20,73	5	A0618S06E
9.6 mm	Steel	26,53	5	A1020S06
9.6 mm	Steel	29,18	5	A1020S06E
12.7 mm	Steel	41,43	5	A1225S06
12.7 mm	Steel	45,56	5	A1225S06E

Limas rotativas ojivales con punta redonda de carburo de tungsteno para acero de alta aleación



F-S

		€		
6 mm	Steel	22,93	5	F0618S06
9.6 mm	Steel	28,91	5	F1020S06
12.7 mm	Steel	42,76	5	F1225S06

Limas rotativas de Carburo de Tungsteno



L-AL

		€		
12.7 mm	AL	87,76	1	L1230AL06
12.7 mm	AL	87,76	1	L1230AL08

Limas rotativas cilíndricas de punta redonda de carburo de tungsteno para acero de alta aleación



C-S

		€		
6 mm	Steel	21,97	5	C0618S06
9.6 mm	Steel	29,56	5	C1020S06
12.7 mm	Steel	46,46	5	C1225S06

Limas rotativas ojivales con punta de carburo de tungsteno para acero de alta aleación



G-S

		€		
9.6 mm	Steel	30,84	5	G1020S06
12.7 mm	Steel	41,95	5	G1225S06

Limas rotativas cónicas con punta redonda de carburo de tungsteno para acero de alta aleación



L-S

Ø	Material	€	Paquetes	Modelos
9.6 mm	Steel	36,98	5	L1020S06
12.7 mm	Steel	45,15	5	L1228S06

Limas rotativas esféricas de carburo de tungsteno para acero inoxidable



D-I

Ø	Material	€	Paquetes	Modelos
3 mm	Inox	13,50	5	D0303I03
6 mm	Inox	22,01	5	D0606I06
9.6 mm	Inox	26,46	5	D1010I06
12.7 mm	Inox	35,69	5	D1212I06

Limas rotativas ojivales con punta de carburo de tungsteno para acero inoxidable



G-I

Ø	Material	€	Paquetes	Modelos
9.6 mm	Inox	33,66	5	G1020I06
12.7 mm	Inox	45,76	5	G1225I06

Limas rotativas cilíndricas de carburo de tungsteno para acero inoxidable



A-I

Ø	Material	€	Paquetes	Modelos
3 mm	Inox	13,50	5	A0314I03
6 mm	Inox	20,57	5	A0618I06
9.6 mm	Inox	28,94	5	A1020I06
12.7 mm	Inox	55,42	5	A1225I06

Limas rotativas ovaladas de carburo de tungsteno para acero inoxidable



E-I

Ø	Material	€	Paquetes	Modelos
9.6 mm	Inox	32,23	5	E1015I06
12.7 mm	Inox	47,21	5	E1220I06

Limas rotativas en forma de llama de carburo de tungsteno para acero inoxidable



H-I

Ø	Material	€	Paquetes	Modelos
9.6 mm	Inox	57,45	5	H1020I06
12.7 mm	Inox	67,55	5	H1232I06

Limas rotativas cilíndricas de punta redonda de carburo de tungsteno para acero inoxidable



C-I

Ø	Material	€	Paquetes	Modelos
3 mm	Inox	13,50	5	C0312I03
6 mm	Inox	23,94	5	C0618I06
9.6 mm	Inox	32,23	5	C1020I06
12.7 mm	Inox	61,23	5	C1225I06

Limas rotativas ojivales con punta redonda de carburo de tungsteno para acero inoxidable



F-I

Ø	Material	€	Paquetes	Modelos
3 mm	Inox	13,50	5	F0312I03
6 mm	Inox	25,00	5	F0618I06
9.6 mm	Inox	31,55	5	F1020I06
12.7 mm	Inox	46,66	5	F1225I06

Limas rotativas cónicas con punta redonda de carburo de tungsteno para acero inoxidable



L-I

Ø	Material	€	Paquetes	Modelos
9.6 mm	Inox	40,32	5	L1020I06
12.7 mm	Inox	49,26	5	L1228I06



Limas rotativas ojivales con punta de carburo de tungsteno para reparación de neumáticos



TR

Ø	Icon	€	Icon	Icon
3 mm	Tire Repair	22,55	5	TR0325M03X-50
4.5 mm	Tire Repair	41,96	5	TR0636M06X-65
6 mm	Tire Repair	47,14	5	TR0650M06X-80
8 in	Tire Repair	62,06	5	TR0860M08X-110
8 mm	Tire Repair	40,29	5	TR4.530M06X-90

Juego de limas rotativas de carburo de tungsteno para metal, 10 y 12 mm, 5 piezas



ST-1-5P

Icon	g	€	Icon	Icon
X	376 g	200,93	1	RB-SET1-M06X-5P

A1020M06XE	
C1225M06X	
F1225M06X	
G1020M06X	
L1230M06X	

Juego de limas rotativas de carburo de tungsteno para metal, 10 mm, 5 piezas



ST-2-5P

Icon	g	€	Icon	Icon
X	313 g	159,25	1	RB-SET2-M06X-5P

A1020M06XE	
C1020M06X	
D1009M06X	
F1020M06X	
L1020M06X	

Juego de limas rotativas de carburo de tungsteno para metal, 10 piezas



ST-10P

Icon	g	€	Icon	Icon
X	542 g	380,50	1	RB-SET-M06X-10P

A1020M06XE, A1225M06X	
C1020M06X, C1225M06X	
D1211M06X	
E1018M06X	
F1225M06X	
G1020M06X, G1225M06X	
L1230M06X	

Juego de limas rotativas de carburo de tungsteno para aluminio, 5 piezas



ALU-5P

Icon	g	€	Icon	Icon
X	380 g	352,31	1	RB-SET-AL06-5P

A1225AL06E	
C1225AL06	
D1211AL06	
F1225AL06	
L1230AL06	

BROCAS

Broca para cemento, SDS Max best



4656

Ø	L	€	Icon	Icon
12.0 mm	340 mm	63,38	1	4656-12-340
12.0 mm	540 mm	74,36	1	4656-12-540
14.0 mm	340 mm	68,08	1	4656-14-340
14.0 mm	540 mm	78,04	1	4656-14-540
15.0 mm	340 mm	78,56	1	4656-15-340
16.0 mm	340 mm	81,18	1	4656-16-340
16.0 mm	540 mm	84,84	1	4656-16-540
16.0 mm	940 mm	157,11	1	4656-16-940
16.0 mm	1320 mm	272,33	1	4656-16-1320
18.0 mm	340 mm	83,28	1	4656-18-340
18.0 mm	540 mm	99,51	1	4656-18-540
18.0 mm	940 mm	151,88	1	4656-18-940
18.0 mm	1320 mm	288,04	1	4656-18-1320
20.0 mm	320 mm	78,56	1	4656-20-320
20.0 mm	520 mm	101,60	1	4656-20-520
20.0 mm	920 mm	144,54	1	4656-20-920
20.0 mm	1320 mm	340,41	1	4656-20-1320
22.0 mm	320 mm	96,36	1	4656-22-320
22.0 mm	520 mm	115,21	1	4656-22-520
22.0 mm	920 mm	157,11	1	4656-22-920
22.0 mm	1320 mm	366,60	1	4656-22-1320
24.0 mm	320 mm	93,23	1	4656-24-320
24.0 mm	520 mm	115,21	1	4656-24-520
25.0 mm	320 mm	102,65	1	4656-25-320
25.0 mm	520 mm	125,69	1	4656-25-520
25.0 mm	920 mm	186,44	1	4656-25-920
25.0 mm	1320 mm	396,98	1	4656-25-1320
26.0 mm	520 mm	125,69	1	4656-26-520
28.0 mm	370 mm	123,59	1	4656-28-370
28.0 mm	570 mm	135,12	1	4656-28-570
28.0 mm	670 mm	170,73	1	4656-28-670
28.0 mm	920 mm	204,25	1	4656-28-920
30.0 mm	370 mm	135,12	1	4656-30-370
30.0 mm	570 mm	144,54	1	4656-30-570
32.0 mm	370 mm	141,41	1	4656-32-370
32.0 mm	570 mm	175,97	1	4656-32-570
32.0 mm	920 mm	239,86	1	4656-32-920
32.0 mm	1320 mm	408,49	1	4656-32-1320
35.0 mm	370 mm	156,07	1	4656-35-370
35.0 mm	570 mm	187,49	1	4656-35-570
35.0 mm	670 mm	219,96	1	4656-35-670
37.0 mm	370 mm	157,11	1	4656-37-370
37.0 mm	570 mm	187,49	1	4656-37-570
37.0 mm	920 mm	282,80	1	4656-37-920
38.0 mm	370 mm	272,33	1	4656-38-370
38.0 mm	570 mm	187,49	1	4656-38-570
40.0 mm	370 mm	183,30	1	4656-40-370
40.0 mm	570 mm	225,20	1	4656-40-570
40.0 mm	920 mm	293,28	1	4656-40-920
40.0 mm	1320 mm	492,29	1	4656-40-1320
45.0 mm	570 mm	303,75	1	4656-45-570
45.0 mm	920 mm	417,92	1	4656-45-920
50.0 mm	570 mm	366,60	1	4656-50-570
52.0 mm	570 mm	429,44	1	4656-52-570

Broca para cemento, SDS best



4651



Ø	L	€			
5.0 mm	115 mm	7,86	1	4651-5-110	
5.0 mm	110 mm	78,61	1	4651-5-110-10P	
5.0 mm	165 mm	8,80	1	4651-5-160	
5.0 mm	160 mm	87,98	1	4651-5-160-10P	
5.0 mm	265 mm	16,34	1	4651-5-260	
5.5 mm	110 mm	106,84	10	4651-5,5-110-10P	
5.5 mm	160 mm	111,03	1	4651-5,5-160-10P	
5.5 mm	115 mm	10,69	1	4651-5,5-110	
5.5 mm	165 mm	11,11	1	4651-5,5-160	
6.0 mm	115 mm	7,86	1	4651-6-110	
6.0 mm	110 mm	78,61	1	4651-6-110-10P	
6.0 mm	165 mm	8,59	1	4651-6-160	
6.0 mm	160 mm	75,16	1	4651-6-160-10P	
6.0 mm	215 mm	11,64	1	4651-6-210	
6.0 mm	265 mm	13,82	1	4651-6-260	
6.0 mm	315 mm	20,43	1	4651-6-310	
6.5 mm	110 mm	11,09	50	4651-6,5-110	
6.5 mm	165 mm	11,22	1	4651-6,5-160	
6.5 mm	160 mm	111,03	1	4651-6,5-160-10P	
6.5 mm	215 mm	15,09	1	4651-6,5-210	
6.5 mm	265 mm	20,12	1	4651-6,5-260	
6.5 mm	315 mm	24,51	1	4651-6,5-310	
7.0 mm	115 mm	10,59	1	4651-7-110	
7.0 mm	165 mm	11,22	1	4651-7-160	
8.0 mm	115 mm	10,26	1	4651-8-110	
8.0 mm	165 mm	10,37	1	4651-8-160	
8.0 mm	160 mm	103,76	1	4651-8-160-10P	
8.0 mm	215 mm	12,89	1	4651-8-210	
8.0 mm	210 mm	128,89	1	4651-8-210-10P	
8.0 mm	265 mm	14,15	1	4651-8-260	
8.0 mm	315 mm	18,13	1	4651-8-310	
8.0 mm	465 mm	29,96	1	4651-8-460	
10.0 mm	115 mm	11,73	1	4651-10-110	
10.0 mm	165 mm	12,47	1	4651-10-160	
10.0 mm	160 mm	124,71	1	4651-10-160-10P	
10.0 mm	215 mm	14,87	1	4651-10-210	
10.0 mm	210 mm	156,49	1	4651-10-210-10P	
10.0 mm	265 mm	19,27	1	4651-10-260	
10.0 mm	315 mm	24,51	1	4651-10-310	
10.0 mm	455 mm	33,52	1	4651-10-450	
10.0 mm	600 mm	42,73	1	4651-10-600	
10.0 mm	1000 mm	100,34	1	4651-10-1000	
12.0 mm	160 mm	15,62	1	4651-12-160	
12.0 mm	160 mm	156,13	1	4651-12-160-10P	
12.0 mm	210 mm	18,65	1	4651-12-210	
12.0 mm	210 mm	186,44	1	4651-12-210-10P	
12.0 mm	260 mm	22,53	1	4651-12-260	
12.0 mm	310 mm	29,23	1	4651-12-310	
12.0 mm	450 mm	36,57	1	4651-12-450	
12.0 mm	600 mm	43,90	1	4651-12-600	
12.0 mm	1000 mm	100,76	1	4651-12-1000	
14.0 mm	160 mm	18,02	1	4651-14-160	
14.0 mm	210 mm	24,10	1	4651-14-210	
14.0 mm	260 mm	26,71	1	4651-14-260	
14.0 mm	310 mm	34,47	1	4651-14-310	
14.0 mm	450 mm	43,37	1	4651-14-450	
14.0 mm	600 mm	60,54	1	4651-14-600	
14.0 mm	1000 mm	135,12	1	4651-14-1000	
15.0 mm	160 mm	27,76	1	4651-15-160	
15.0 mm	260 mm	36,14	1	4651-15-260	
15.0 mm	450 mm	46,83	1	4651-15-450	
16.0 mm	160 mm	34,47	1	4651-16-160	
16.0 mm	210 mm	38,65	1	4651-16-210	
16.0 mm	260 mm	44,73	1	4651-16-260	
16.0 mm	310 mm	46,61	1	4651-16-310	
16.0 mm	450 mm	58,55	1	4651-16-450	
16.0 mm	600 mm	78,56	1	4651-16-600	

Ø	L	€			
16.0 mm	1000 mm	160,26	1	4651-16-1000	
18.0 mm	250 mm	59,92	1	4651-18-250	
18.0 mm	450 mm	70,38	1	4651-18-450	
20.0 mm	250 mm	68,08	1	4651-20-250	
20.0 mm	450 mm	80,55	1	4651-20-450	
22.0 mm	250 mm	81,60	1	4651-22-250	
22.0 mm	450 mm	97,10	1	4651-22-450	
24.0 mm	250 mm	82,92	1	4651-24-250	
24.0 mm	450 mm	102,75	1	4651-24-450	
25.0 mm	250 mm	85,19	1	4651-25-250	
25.0 mm	450 mm	104,22	1	4651-25-450	
28.0 mm	250 mm	98,46	1	4651-28-250	
28.0 mm	450 mm	119,41	1	4651-28-450	
30.0 mm	250 mm	125,93	1	4651-30-250	
30.0 mm	450 mm	130,93	1	4651-30-450	
32.0 mm	450 mm	169,69	1	4651-32-450	

Juego de 5 brocas SDS para hormigón armado



4651-SET-5



X	€		
5	43,75	1	4651-SET-5

4651-5-110, 4651-6-110, 4651-6-160, 4651-8-160, 4651-10-160

Juego de 7 brocas SDS para hormigón armado



4651-SET-7



X	€		
7	66,41	1	4651-SET-7

4651-5-110, 4651-6-110, 4651-8-110, 4651-6-160, 4651-8-160, 4651-10-160, 4651-12-160

Brocas para cemento, SDS



4652



Ø	L	€			
3.0 mm	110 mm	8,38	50	4652-3-110	
3.5 mm	110 mm	8,38	50	4652-3,5-110	
4.0 mm	110 mm	5,76	1	4652-4-110	
4.0 mm	160 mm	6,91	1	4652-4-160	
5.0 mm	110 mm	4,17	1	4652-5-110	
5.0 mm	160 mm	5,45	1	4652-5-160	
5.0 mm	110 mm	41,78	1	4652-5-110-10P	
5.0 mm	160 mm	54,46	1	4652-5-160-10P	
5.0 mm	210 mm	8,59	1	4652-5-210	
5.5 mm	110 mm	4,93	1	4652-5,5-110	
5.5 mm	110 mm	49,29	10	4652-5,5-110-10P	
5.5 mm	160 mm	6,19	1	4652-5,5-160	
5.5 mm	160 mm	61,86	1	4652-5,5-160-10P	
5.5 mm	210 mm	8,38	50	4652-5,5-210	
6.0 mm	110 mm	4,30	1	4652-6-110	
6.0 mm	110 mm	43,01	1	4652-6-110-10P	
6.0 mm	160 mm	5,03	50	4652-6-160	
6.0 mm	160 mm	50,28	1	4652-6-160-10P	
6.0 mm	210 mm	8,17	1	4652-6-210	
6.0 mm	260 mm	10,46	1	4652-6-260	
6.5 mm	110 mm	4,93	1	4652-6,5-110	
6.5 mm	160 mm	5,76	1	4652-6,5-160	
6.5 mm	160 mm	57,67	1	4652-6,5-160-10P	
7.0 mm	110 mm	6,19	1	4652-7-110	
7.0 mm	160 mm	6,61	1	4652-7-160	
8.0 mm	110 mm	5,14	1	4652-8-110	
8.0 mm	160 mm	5,45	1	4652-8-160	
8.0 mm	160 mm	54,46	1	4652-8-160-10P	
8.0 mm	210 mm	7,32	1	4652-8-210	
8.0 mm	210 mm	73,20	1	4652-8-210-10P	
8.0 mm	260 mm	10,37	1	4652-8-260	
8.0 mm	460 mm	21,90	1	4652-8-460	
9.0 mm	160 mm	8,28	1	4652-9-160	
9.0 mm	210 mm	9,01	1	4652-9-210	
10.0 mm	110 mm	6,19	1	4652-10-110	
10.0 mm	160 mm	6,91	1	4652-10-160	
10.0 mm	160 mm	69,13	1	4652-10-160-10P	
10.0 mm	210 mm	8,28	1	4652-10-210	
10.0 mm	210 mm	82,81	1	4652-10-210-10P	
10.0 mm	260 mm	12,15	1	4652-10-260	
10.0 mm	310 mm	14,15	1	4652-10-310	
10.0 mm	450 mm	22,95	1	4652-10-450	
10.0 mm	600 mm	32,06	1	4652-10-600	
11.0 mm	160 mm	9,12	1	4652-11-160	
11.0 mm	260 mm	14,15	1	4652-11-260	
12.0 mm	160 mm	7,32	1	4652-12-160	
12.0 mm	160 mm	73,20	1	4652-12-160-10P	
12.0 mm	210 mm	9,33	1	4652-12-210	
12.0 mm	210 mm	93,28	1	4652-12-210-10P	
12.0 mm	260 mm	13,31	1	4652-12-260	
12.0 mm	310 mm	17,70	1	4652-12-310	



Ø	L	€		
12.0 mm	450 mm	20,85	1	4652-12-450
12.0 mm	600 mm	33,21	1	4652-12-600
12.0 mm	1000 mm	79,30	1	4652-12-1000
13.0 mm	310 mm	17,17	1	4652-13-310
14.0 mm	160 mm	10,06	1	4652-14-160
14.0 mm	210 mm	14,71	1	4652-14-210
14.0 mm	260 mm	17,70	1	4652-14-260
14.0 mm	310 mm	18,65	1	4652-14-310
14.0 mm	450 mm	24,51	1	4652-14-450
14.0 mm	600 mm	36,35	1	4652-14-600
14.0 mm	1000 mm	86,21	1	4652-14-1000
15.0 mm	260 mm	18,33	1	4652-15-260
16.0 mm	210 mm	17,08	1	4652-16-210
16.0 mm	260 mm	18,44	1	4652-16-260
16.0 mm	310 mm	19,69	1	4652-16-310
16.0 mm	450 mm	29,11	1	4652-16-450
16.0 mm	600 mm	39,17	1	4652-16-600
16.0 mm	1000 mm	97,94	1	4652-16-1000
18.0 mm	200 mm	21,90	1	4652-18-200
18.0 mm	300 mm	29,23	1	4652-18-300
18.0 mm	450 mm	33,31	1	4652-18-450
18.0 mm	1000 mm	100,67	1	4652-18-1000
20.0 mm	200 mm	30,49	1	4652-20-200
20.0 mm	300 mm	34,26	1	4652-20-300
20.0 mm	450 mm	43,15	1	4652-20-450
20.0 mm	600 mm	63,90	1	4652-20-600
20.0 mm	1000 mm	101,60	1	4652-20-1000
22.0 mm	250 mm	39,17	1	4652-22-250
22.0 mm	450 mm	54,46	1	4652-22-450
22.0 mm	600 mm	65,26	1	4652-22-600
22.0 mm	1000 mm	102,65	1	4652-22-1000
24.0 mm	250 mm	45,57	1	4652-24-250
24.0 mm	450 mm	59,29	1	4652-24-450
25.0 mm	250 mm	49,44	1	4652-25-250
25.0 mm	450 mm	63,47	1	4652-25-450
25.0 mm	1000 mm	114,17	1	4652-25-1000
26.0 mm	250 mm	61,80	1	4652-26-250
26.0 mm	450 mm	70,18	1	4652-26-450

Juego de 5 brocas SDS para hormigón armado



4652-SET-5

X	€		
5	18,48	1	4652-SET-5

4652-5-110, 4652-6-110, 4652-6-160, 4652-8-160, 4652-10-160

Juego de 7 brocas SDS para hormigón armado



4652-SET-7

X	€		
7	28,83	1	4652-SET-7

4652-5-110, 4652-6-110, 4652-8-110, 4652-6-160, 4652-8-160, 4652-10-160, 4652-12-160

Brocas para cemento



4641

Ø	L	€		
3.0 mm	60 mm	3,27	1	4641-3-60
4.0 mm	75 mm	3,44	1	4641-4-75
5.0 mm	85 mm	3,60	1	4641-5-85
5.0 mm	150 mm	4,75	1	4641-5-150
5.5 mm	85 mm	3,60	1	4641-5,5-85
6.0 mm	100 mm	3,71	1	4641-6-100
6.0 mm	150 mm	4,93	1	4641-6-150
6.0 mm	400 mm	12,32	1	4641-6-400
6.5 mm	100 mm	3,71	1	4641-6,5-100
7.0 mm	100 mm	4,19	1	4641-7-100
8.0 mm	120 mm	4,86	1	4641-8-120
8.0 mm	200 mm	7,15	1	4641-8-200
8.0 mm	400 mm	13,06	1	4641-8-400
9.0 mm	120 mm	4,86	1	4641-9-120
10.0 mm	120 mm	5,49	1	4641-10-120
10.0 mm	200 mm	8,49	1	4641-10-200
10.0 mm	400 mm	13,95	1	4641-10-400
10.0 mm	600 mm	15,45	1	4641-10-600
11.0 mm	150 mm	6,35	1	4641-11-150
12.0 mm	150 mm	7,46	1	4641-12-150
12.0 mm	200 mm	10,53	1	4641-12-200
12.0 mm	400 mm	14,82	1	4641-12-400
12.0 mm	600 mm	16,81	1	4641-12-600
13.0 mm	150 mm	10,53	1	4641-13-150
14.0 mm	150 mm	12,26	1	4641-14-150
14.0 mm	400 mm	18,20	1	4641-14-400
14.0 mm	600 mm	20,39	1	4641-14-600
16.0 mm	150 mm	13,55	1	4641-16-150
16.0 mm	400 mm	20,22	1	4641-16-400

Ø	L	€		
16.0 mm	600 mm	26,02	1	4641-16-600
18.0 mm	400 mm	29,52	1	4641-18-400
18.0 mm	600 mm	35,03	1	4641-18-600
20.0 mm	400 mm	31,29	1	4641-20-400
20.0 mm	600 mm	40,59	1	4641-20-600
22.0 mm	400 mm	35,96	1	4641-22-400
24.0 mm	400 mm	37,28	1	4641-24-400
25.0 mm	400 mm	42,58	1	4641-25-400

Juego de 5 brocas para cemento



4641-PB

X	g	€		
5	185 g	21,50	1	4641-PB

4641-4-75, 4641-5-85, 4641-6-100, 4641-8-120, 4641-10-120

Juego de 5 brocas para albañilería con punta de carburo



4643-PB

X	g	€		
5	150 g	12,63	1	4643-PB

4mm, 5mm, 6mm, 8mm and 10mm

Cinceles para cemento, cinceles SDS Max



4659



Ø	L	€		
- mm	280 mm	16,76	1	4659-POINT-28
- mm	400 mm	20,01	1	4659-POINT-40
- mm	600 mm	27,03	1	4659-POINT-60
24.0 mm	280 mm	17,29	1	4659-FLAT-28
24.0 mm	400 mm	20,01	1	4659-FLAT-40
24.0 mm	600 mm	25,98	1	4659-FLAT-60
80.0 mm	300 mm	44,83	1	4659-WIDE-30-8
50.0 mm	360 mm	29,86	1	4659-WIDE-36-5
50.0 mm	300 mm	47,35	1	4659-TILE-30-5
80.0 mm	300 mm	49,76	1	4659-TILE-30-8

Brocas para cemento, cinceles SDS



4655



Ø	L	€		
20.0 mm	250 mm	11,11	1	4655-FLAT-250
22.0 mm	240 mm	22,83	1	4655-HOLLOW-240
- mm	250 mm	11,11	1	4655-POINT-250
32.0 mm	200 mm	146,64	1	4655-SLOT-25032
38.0 mm	200 mm	21,58	1	4655-TILE-20040
38.0 mm	200 mm	18,85	1	4655-WIDE-20040
22.0 mm	250 mm	54,99	1	4655-WING-C-250

Broca para metal HSS-E, Cobalto



4411



Ø	L	€		
1.00 mm	34 mm	4,72	1	4411-1.00
1.50 mm	40 mm	4,40	1	4411-1.50
2.00 mm	49 mm	4,61	1	4411-2.00
2.50 mm	57 mm	4,14	1	4411-2.50
3.00 mm	61 mm	3,98	1	4411-3.00
3.25 mm	65 mm	4,82	1	4411-3.25
3.30 mm	65 mm	4,82	1	4411-3.30
3.50 mm	70 mm	4,72	1	4411-3.50
4.00 mm	75 mm	5,14	1	4411-4.00
4.20 mm	75 mm	2,83	1	4411-4.20
4.25 mm	75 mm	2,83	1	4411-4.25
4.50 mm	80 mm	2,93	1	4411-4.50
5.00 mm	86 mm	3,04	1	4411-5.00
5.50 mm	93 mm	3,82	1	4411-5.50
6.00 mm	93 mm	3,98	1	4411-6.00
6.50 mm	101 mm	4,72	1	4411-6.50
6.80 mm	109 mm	4,51	1	4411-6.80

Ø	L	€		
7.00 mm	109 mm	5,14	1	4411-7.00
7.50 mm	109 mm	5,56	1	4411-7.50
8.00 mm	117 mm	6,49	1	4411-8.00
8.50 mm	117 mm	6,81	1	4411-8.50
9.00 mm	125 mm	8,59	1	4411-9.00
9.50 mm	125 mm	8,70	1	4411-9.50
10.00 mm	125 mm	9,54	1	4411-10.00
10.20 mm	133 mm	13,52	1	4411-10.20
10.50 mm	133 mm	14,17	1	4411-10.50
11.00 mm	142 mm	14,87	1	4411-11.00
11.50 mm	142 mm	16,95	1	4411-11.50
12.00 mm	151 mm	19,07	1	4411-12.00
12.50 mm	151 mm	21,38	1	4411-12.50
13.00 mm	151 mm	23,78	1	4411-13.00

Broca para metal HSS-E, Cobalto



4511

Ø	L	€		
0.50 mm	22 mm	26,60	1	4511-0.50-10P
0.75 mm	28 mm	24,04	1	4511-0.75-10P
1.00 mm	34 mm	19,48	1	4511-1.00-10P
1.50 mm	40 mm	18,55	1	4511-1.50-10P
1.75 mm	46 mm	23,25	1	4511-1.75-10P
2.00 mm	49 mm	19,48	1	4511-2.00-10P
2.50 mm	57 mm	17,70	1	4511-2.50-10P
2.70 mm	61 mm	21,94	1	4511-2.70-10P
2.90 mm	61 mm	21,94	1	4511-2.90-10P
3.00 mm	61 mm	17,29	1	4511-3.00-10P
3.10 mm	65 mm	21,15	1	4511-3.10-10P
3.25 mm	65 mm	21,15	1	4511-3.25-10P
3.30 mm	65 mm	21,15	1	4511-3.30-10P
3.50 mm	70 mm	21,15	1	4511-3.50-10P
3.80 mm	75 mm	26,60	1	4511-3.80-10P
4.00 mm	75 mm	22,42	1	4511-4.00-10P
4.20 mm	75 mm	24,93	1	4511-4.20-10P
4.50 mm	80 mm	25,13	1	4511-4.50-10P
4.80 mm	86 mm	29,54	1	4511-4.80-10P
5.00 mm	86 mm	26,60	1	4511-5.00-10P
5.20 mm	86 mm	32,16	1	4511-5.20-10P
5.50 mm	93 mm	33,73	1	4511-5.50-10P
6.00 mm	93 mm	35,82	1	4511-6.00-10P
6.20 mm	101 mm	44,83	1	4511-6.20-10P
6.50 mm	101 mm	43,05	1	4511-6.50-10P
6.80 mm	109 mm	50,18	1	4511-6.80-10P
7.00 mm	109 mm	47,24	1	4511-7.00-10P
7.20 mm	109 mm	68,34	1	4511-7.20-10P
7.50 mm	109 mm	50,18	1	4511-7.50-10P
7.80 mm	117 mm	82,23	1	4511-7.80-10P
8.00 mm	117 mm	59,07	1	4511-8.00-10P
8.50 mm	117 mm	61,17	1	4511-8.50-10P
8.60 mm	125 mm	100,04	1	4511-8.60-10P
8.80 mm	125 mm	100,04	1	4511-8.80-10P
9.00 mm	125 mm	78,56	1	4511-9.00-10P
9.20 mm	125 mm	110,93	1	4511-9.20-10P
9.50 mm	125 mm	81,18	1	4511-9.50-10P
9.60 mm	133 mm	130,41	1	4511-9.60-10P
10.00 mm	133 mm	44,53	1	4511-10.00-5P
10.20 mm	133 mm	62,85	1	4511-10.20-5P
10.30 mm	133 mm	74,89	1	4511-10.30-5P
10.50 mm	133 mm	63,05	1	4511-10.50-5P
10.80 mm	142 mm	87,15	1	4511-10.80-5P
11.00 mm	142 mm	69,66	1	4511-11.00-5P
11.50 mm	142 mm	83,28	1	4511-11.50-5P
12.00 mm	151 mm	89,25	1	4511-12.00-5P
12.50 mm	151 mm	108,67	1	4511-12.50-5P
12.80 mm	151 mm	124,12	1	4511-12.80-5P
13.00 mm	151 mm	111,03	1	4511-13.00-5P

Ø	L	€		
13.50 mm	160 mm	24,51	1	4511-13.50-1P
14.00 mm	160 mm	24,20	1	4511-14.00-1P
14.50 mm	169 mm	34,36	1	4511-14.50-1P
15.00 mm	169 mm	34,89	1	4511-15.00-1P
15.50 mm	169 mm	40,43	1	4511-15.50-1P
16.00 mm	178 mm	41,80	1	4511-16.00-1P
16.50 mm	184 mm	47,76	1	4511-16.50-1P
17.00 mm	184 mm	47,76	1	4511-17.00-1P
17.50 mm	191 mm	53,00	1	4511-17.50-1P
18.00 mm	191 mm	57,72	1	4511-18.00-1P
18.50 mm	198 mm	63,68	1	4511-18.50-1P
19.00 mm	198 mm	63,80	1	4511-19.00-1P
19.50 mm	205 mm	70,71	1	4511-19.50-1P
20.00 mm	205 mm	75,74	1	4511-20.00-1P

Juego de 6 brocas para metal, Cobalto



4511-SET-6

X	g	€		
6	150 g	20,33	1	4511-SET-6

2.0 a 8.0 mm x 1.0 mm (excl. 7.0 mm) en un soporte de plástico

4411-2.00, 4411-3.00, 4411-4.00, 4411-5.00, 4411-6.00, 4411-8.00

Juego de 19 brocas para metal, Cobalto



4511-SET-19

X	g	€		
19	600 g	82,65	1	4511-SET-19

1.0 a 10.0 mm x 0.5 mm en caja de plástico

4411-1.00, 4411-1.50, 4411-2.00, 4411-2.50, 4411-3.00, 4411-3.50, 4411-4.00, 4411-4.50, 4411-5.00, 4411-5.50, 4411-6.00, 4411-6.50, 4411-7.00, 4411-7.50, 4411-8.00, 4411-8.50, 4411-9.00, 4411-9.50, 4411-10.00



Juego de 25 brocas para metal, Cobalto



4511-SET-25

X	g	€		
25	1200 g	193,77	1	4511-SET-25

1pc 13.0mm



Broca para metal HSS-G



4413

Ø	L	€		
---	---	---	--	--

1.00 mm	34 mm	3,45	1	4413-1.00
1.50 mm	40 mm	2,73	1	4413-1.50
2.00 mm	49 mm	2,73	1	4413-2.00
2.50 mm	57 mm	2,73	1	4413-2.50
3.00 mm	61 mm	2,77	1	4413-3.00
3.25 mm	65 mm	2,77	1	4413-3.25
3.30 mm	65 mm	2,77	1	4413-3.30
3.50 mm	70 mm	2,77	1	4413-3.50
4.00 mm	75 mm	2,97	1	4413-4.00
4.20 mm	75 mm	1,85	1	4413-4.20
4.25 mm	75 mm	1,85	1	4413-4.25
4.50 mm	80 mm	1,95	1	4413-4.50
5.00 mm	86 mm	2,11	1	4413-5.00
5.50 mm	93 mm	2,90	1	4413-5.50
6.00 mm	93 mm	2,90	1	4413-6.00
6.50 mm	101 mm	3,39	1	4413-6.50
6.80 mm	109 mm	3,82	1	4413-6.80
7.00 mm	109 mm	3,98	1	4413-7.00
7.50 mm	109 mm	4,27	1	4413-7.50
8.00 mm	117 mm	4,54	1	4413-8.00
8.50 mm	117 mm	4,93	1	4413-8.50
9.00 mm	125 mm	6,27	1	4413-9.00
9.50 mm	125 mm	5,82	1	4413-9.50
10.00 mm	133 mm	5,95	1	4413-10.00
10.20 mm	133 mm	7,64	1	4413-10.20
10.50 mm	133 mm	7,95	25	4413-10.50
11.00 mm	142 mm	8,75	1	4413-11.00
11.50 mm	142 mm	9,48	25	4413-11.50
12.00 mm	151 mm	10,34	1	4413-12.00
12.50 mm	151 mm	11,28	25	4413-12.50
13.00 mm	151 mm	11,83	1	4413-13.00



Broca para metal HSS-G



4513

Ø	L	€		
---	---	---	--	--

1.00 mm	34 mm	17,29	1	4513-1.00-10P
1.50 mm	40 mm	12,89	1	4513-1.50-10P
1.75 mm	46 mm	14,35	1	4513-1.75-10P
2.00 mm	49 mm	12,15	1	4513-2.00-10P
2.50 mm	57 mm	12,47	1	4513-2.50-10P
2.70 mm	61 mm	15,09	1	4513-2.70-10P
2.90 mm	61 mm	15,09	1	4513-2.90-10P
3.00 mm	61 mm	11,00	1	4513-3.00-10P
3.10 mm	65 mm	12,89	1	4513-3.10-10P
3.25 mm	65 mm	12,89	1	4513-3.25-10P
3.30 mm	65 mm	12,89	1	4513-3.30-10P
3.50 mm	70 mm	12,89	1	4513-3.50-10P
3.80 mm	75 mm	18,33	1	4513-3.80-10P
4.00 mm	75 mm	16,34	1	4513-4.00-10P
4.20 mm	75 mm	18,02	1	4513-4.20-10P
4.50 mm	80 mm	18,85	1	4513-4.50-10P
4.80 mm	86 mm	20,64	1	4513-4.80-10P
5.00 mm	86 mm	20,69	1	4513-5.00-10P
5.20 mm	86 mm	23,05	1	4513-5.20-10P
5.50 mm	93 mm	26,81	1	4513-5.50-10P
6.00 mm	93 mm	27,65	1	4513-6.00-10P
6.20 mm	101 mm	31,42	1	4513-6.20-10P
6.50 mm	101 mm	32,26	1	4513-6.50-10P
6.80 mm	109 mm	36,87	1	4513-6.80-10P
7.00 mm	109 mm	38,97	1	4513-7.00-10P
7.20 mm	109 mm	49,23	1	4513-7.20-10P
7.50 mm	109 mm	41,48	1	4513-7.50-10P
7.80 mm	117 mm	60,26	1	4513-7.80-10P
8.00 mm	117 mm	46,93	1	4513-8.00-10P
8.50 mm	117 mm	51,11	1	4513-8.50-10P
8.60 mm	125 mm	80,96	1	4513-8.60-10P
8.80 mm	125 mm	82,68	1	4513-8.80-10P
9.00 mm	125 mm	62,00	1	4513-9.00-10P
9.20 mm	125 mm	84,04	1	4513-9.20-10P
9.50 mm	125 mm	59,76	1	4513-9.50-10P
9.60 mm	133 mm	95,01	1	4513-9.60-10P
10.00 mm	133 mm	30,13	1	4513-10.00-5P
10.20 mm	133 mm	37,90	1	4513-10.20-5P
10.30 mm	133 mm	48,06	1	4513-10.30-5P
10.50 mm	133 mm	39,43	1	4513-10.50-5P
10.80 mm	142 mm	59,28	1	4513-10.80-5P
11.00 mm	142 mm	43,07	1	4513-11.00-5P
11.50 mm	142 mm	47,13	1	4513-11.50-5P
12.00 mm	151 mm	51,45	1	4513-12.00-5P
12.50 mm	151 mm	56,31	1	4513-12.50-5P
12.80 mm	151 mm	98,58	1	4513-12.80-5P
13.00 mm	151 mm	58,84	1	4513-13.00-5P
13.50 mm	160 mm	20,32	1	4513-13.50-1P
14.00 mm	160 mm	21,87	1	4513-14.00-1P
14.50 mm	169 mm	23,46	1	4513-14.50-1P
15.00 mm	169 mm	23,76	1	4513-15.00-1P
15.50 mm	178 mm	27,15	1	4513-15.50-1P
16.00 mm	178 mm	28,94	1	4513-16.00-1P
16.50 mm	184 mm	32,01	1	4513-16.50-1P
17.00 mm	184 mm	32,01	1	4513-17.00-1P
17.50 mm	191 mm	36,84	1	4513-17.50-1P
18.00 mm	191 mm	38,97	1	4513-18.00-1P

Ø	L	€		
18.50 mm	198 mm	43,24	1	4513-18.50-1P
19.00 mm	198 mm	43,24	1	4513-19.00-1P
19.50 mm	205 mm	46,39	1	4513-19.50-1P
20.00 mm	205 mm	52,79	1	4513-20.00-1P

Juego de 6 brocas para metal



4513-SET-6

X	g	€		
6	150 g	15,89	1	4513-SET-6

2.0 a 8.0 mm x 1.0 mm (excl. 7.0 mm) en un soporte de plástico

4413-2.00, 4413-3.00, 4413-4.00, 4413-5.00, 4413-6.00, 4413-8.00

Juego de 19 brocas para metal



4513-SET-19

X	g	€		
19	600 g	57,11	1	4513-SET-19

4413-1.00, 4413-1.50, 4413-2.00, 4413-2.50, 4413-3.00, 4413-3.50, 4413-4.00, 4413-4.50, 4413-5.00, 4413-5.50, 4413-6.00, 4413-6.50, 4413-7.00, 4413-7.50, 4413-8.00, 4413-8.50, 4413-9.00, 4413-9.50, 4413-10.00

Juego de 25 brocas para metal



4513-SET-25

		€		
25	1200 g	121,82	1	4513-SET-25

1x 1.0; 1.5; 2.0; 2.5; 3.0; 3.5; 4.0; 4.5; 5.0; 5.5; 6.0; 6.5; 7.0; 7.5; 8.0; 8.5; 9.0; 9.5; 10.0; 10.5; 11.0; 11.5; 12; 12.5; 13.0 mm 1pc 13.0mm

Broca para metal HSS-R



4415

		€		
1.00 mm	34 mm	0,91	1	4415-1.00
1.50 mm	40 mm	0,91	1	4415-1.50
2.00 mm	49 mm	0,91	1	4415-2.00
2.50 mm	57 mm	0,91	1	4415-2.50
3.00 mm	61 mm	0,91	1	4415-3.00
3.25 mm	65 mm	1,04	1	4415-3.25
3.50 mm	70 mm	1,12	1	4415-3.50
4.00 mm	75 mm	1,12	1	4415-4.00
4.25 mm	75 mm	0,76	1	4415-4.25
4.50 mm	80 mm	0,83	1	4415-4.50
5.00 mm	86 mm	0,83	1	4415-5.00
5.50 mm	93 mm	0,91	1	4415-5.50
6.00 mm	93 mm	0,95	1	4415-6.00
6.50 mm	101 mm	1,04	1	4415-6.50
7.00 mm	109 mm	1,12	1	4415-7.00
7.50 mm	109 mm	1,31	1	4415-7.50
8.00 mm	117 mm	1,58	1	4415-8.00
8.50 mm	117 mm	1,78	1	4415-8.50
9.00 mm	125 mm	1,88	1	4415-9.00
10.00 mm	125 mm	2,21	1	4415-10.00
10.50 mm	133 mm	2,40	1	4415-10.50
11.00 mm	142 mm	2,93	1	4415-11.00
11.50 mm	142 mm	3,15	1	4415-11.50
12.00 mm	151 mm	3,46	1	4415-12.00

		€		
12.50 mm	151 mm	3,68	1	4415-12.50
13.00 mm	151 mm	3,88	1	4415-13.00
13.50 mm	160 mm	5,18	1	4415-13.50
14.00 mm	160 mm	5,55	1	4415-14.00
14.50 mm	169 mm	6,28	1	4415-14.50
15.00 mm	169 mm	6,78	1	4415-15.00
15.50 mm	178 mm	7,52	1	4415-15.50
16.00 mm	178 mm	8,06	1	4415-16.00
16.50 mm	184 mm	8,61	1	4415-16.50
17.00 mm	184 mm	9,11	1	4415-17.00
17.50 mm	191 mm	10,06	1	4415-17.50
18.00 mm	191 mm	10,41	1	4415-18.00
18.50 mm	198 mm	11,33	1	4415-18.50
19.00 mm	198 mm	11,83	1	4415-19.00
19.50 mm	205 mm	12,31	1	4415-19.50
20.00 mm	205 mm	12,93	1	4415-20.00

Brocas para metal HSS-R Drill , embalaje industrial



4515

		€		
1.00 mm	34 mm	3,66	1	4515-1.00-10P
1.50 mm	40 mm	3,66	1	4515-1.50-10P
2.00 mm	49 mm	3,66	1	4515-2.00-10P
2.50 mm	57 mm	3,66	1	4515-2.50-10P
3.00 mm	61 mm	3,66	1	4515-3.00-10P
3.25 mm	65 mm	5,03	1	4515-3.25-10P
3.50 mm	70 mm	5,48	1	4515-3.50-10P
4.00 mm	75 mm	5,48	1	4515-4.00-10P
4.25 mm	75 mm	6,77	1	4515-4.25-10P
4.50 mm	80 mm	6,77	1	4515-4.50-10P
5.00 mm	86 mm	7,25	1	4515-5.00-10P
5.50 mm	93 mm	8,22	1	4515-5.50-10P
6.00 mm	93 mm	8,70	1	4515-6.00-10P
6.50 mm	101 mm	9,18	1	4515-6.50-10P
7.00 mm	109 mm	12,70	1	4515-7.00-10P
7.50 mm	109 mm	14,01	1	4515-7.50-10P
8.00 mm	117 mm	14,99	1	4515-8.00-10P
8.50 mm	117 mm	18,33	1	4515-8.50-10P
9.00 mm	125 mm	20,58	1	4515-9.00-10P
9.50 mm	125 mm	22,86	1	4515-9.50-10P
10.00 mm	133 mm	23,05	1	4515-10.00-10P
10.50 mm	133 mm	12,70	1	4515-10.50-5P
11.00 mm	142 mm	14,82	1	4515-11.00-5P
11.50 mm	142 mm	15,77	1	4515-11.50-5P
12.00 mm	151 mm	16,23	1	4515-12.00-5P
12.50 mm	151 mm	17,38	1	4515-12.50-5P
13.00 mm	151 mm	18,53	1	4515-13.00-5P

Juego de 19 brocas para metal



4515-SET-19

		€		
19	600 g	22,62	1	4515-SET-19

1pc 10.0mm

Brocas para metal HSS-R Drill , 25 piezas



4515-SET-25

		€		
25	1200 g	44,21	1	4515-SET-25

1x 1.0; 1.5; 2.0; 2.5; 3.0; 3.5; 4.0; 4.5; 5.0; 5.5; 6.0; 6.5; 7; 7.5; 8; 8.5; 9.0; 9.5; 10; 10.5; 11; 11.5; 12; 12.5; 13 mm

Broca escalonada de 4 a 12 mm



228-SD

		€		
6.35 mm	4-5-6-7-8-9-10-11-12 mm	23,68	24	228-SD



Broca escalonada de 4 a 22 mm



229-SD

Ø	L	€	Paquete	Artículo
10 mm	4-6-8-10-12-14-16-18-20-22 mm	32,46	24	229-SD

Broca escalonada 6.5 a 40.5mm



234-SD

Ø	L	€	Paquete	Artículo
10 mm	6.5-8.5-10.5-12.5-16.5-20.5-25.5-29-32.5-36.5-40.5 mm	138,79	25	234-SD

Broca helicoidal para madera



9626

Ø	€	Paquete	Artículo
6.0 mm	14,70	1	9626-6
7.0 mm	15,11	1	9626-7
8.0 mm	15,48	1	9626-8
9.0 mm	16,07	1	9626-9
10.0 mm	16,43	1	9626-10
11.0 mm	16,71	1	9626-11
12.0 mm	17,08	1	9626-12
13.0 mm	17,52	1	9626-13
14.0 mm	18,05	1	9626-14
15.0 mm	18,85	1	9626-15
16.0 mm	20,67	1	9626-16
18.0 mm	26,38	1	9626-18
20.0 mm	29,90	1	9626-20
22.0 mm	33,42	1	9626-22
23.0 mm	35,04	1	9626-23
24.0 mm	36,63	1	9626-24
25.0 mm	38,31	1	9626-25
26.0 mm	39,98	1	9626-26
28.0 mm	47,19	1	9626-28
30.0 mm	67,56	1	9626-30
32.0 mm	67,56	1	9626-32
35.0 mm	67,56	1	9626-35
6.0 mm	25,23	1	9627-6-460
8.0 mm	25,58	1	9627-8-460
10.0 mm	25,91	1	9627-10-460
12.0 mm	26,24	1	9627-12-460
14.0 mm	28,26	1	9627-14-460
16.0 mm	29,60	1	9627-16-460
18.0 mm	34,32	1	9627-18-460
20.0 mm	38,69	1	9627-20-460
22.0 mm	40,37	1	9627-22-460
24.0 mm	43,75	1	9627-24-460
26.0 mm	47,10	1	9627-26-460
28.0 mm	48,78	1	9627-28-460
30.0 mm	59,70	1	9627-30-460
32.0 mm	67,28	1	9627-32-460

Broca escalonada de 13 niveles



230-SD

Ø	L	€	Paquete	Artículo
12.7 mm	5-13-15-17-19-21-23-25-27-29-31-33-35 mm	72,93	25	230-SD

Juego brocas escalonadas acero rápido 4-30mm



228-SET

Paquete	Peso	€	Paquete	Artículo
3	560 g	130,27	1	228-SET-SD

228-SD

229-SD

230-SD

Broca escalonada 6 a 37mm



232-SD

Ø	L	€	Paquete	Artículo
10 mm	6-9-12.5-15.2-18.6-20.4-22.5-26-28.3-30.5-34-37 mm	124,05	1	232-SD

Brocas HSS-G para metal



4435

Ø	L	€	Paquete	Artículo
12.4 mm	56 mm	7,61	1	4435-12.4

Juego 6 brocas helicoidales



SB-9526/S6

Paquete	€	Paquete	Artículo
6	47,03	20	SB-9526/S6

9526-10, 9526-13, 9526-19, 9526-22, 9526-25

9526-16

Brocas planas para madera



9629

Ø	L	€		
6.0 mm	152 mm	7,07	1	9629-6
8.0 mm	152 mm	5,28	1	9629-8
10.0 mm	152 mm	6,01	1	9629-10
12.0 mm	152 mm	6,01	1	9629-12
13.0 mm	152 mm	5,70	1	9629-13
14.0 mm	152 mm	6,38	1	9629-14
16.0 mm	152 mm	6,38	1	9629-16
17.0 mm	152 mm	6,38	1	9629-17
18.0 mm	152 mm	6,38	1	9629-18
19.0 mm	152 mm	6,38	1	9629-19
20.0 mm	152 mm	6,95	1	9629-20
22.0 mm	152 mm	6,95	1	9629-22
24.0 mm	152 mm	6,95	1	9629-24
25.0 mm	152 mm	6,95	1	9629-25
26.0 mm	152 mm	6,59	1	9629-26
28.0 mm	152 mm	10,85	1	9629-28
30.0 mm	152 mm	10,89	1	9629-30
32.0 mm	152 mm	10,94	1	9629-32
35.0 mm	152 mm	10,75	1	9629-35
36.0 mm	152 mm	11,64	1	9629-36
38.0 mm	152 mm	12,78	1	9629-38
40.0 mm	152 mm	12,78	1	9629-40
6.0 mm	400 mm	9,67	1	9631-6-400
8.0 mm	400 mm	9,67	1	9631-8-400
10.0 mm	400 mm	10,17	1	9631-10-400
12.0 mm	400 mm	11,28	1	9631-12-400
13.0 mm	400 mm	8,80	1	9631-13-400
14.0 mm	400 mm	9,64	1	9631-14-400
16.0 mm	400 mm	10,62	1	9631-16-400
18.0 mm	400 mm	11,97	1	9631-18-400
19.0 mm	400 mm	10,84	1	9631-19-400
20.0 mm	400 mm	11,97	1	9631-20-400
22.0 mm	400 mm	13,85	1	9631-22-400
24.0 mm	400 mm	14,87	1	9631-24-400
25.0 mm	400 mm	14,50	1	9631-25-400
28.0 mm	400 mm	18,04	1	9631-28-400
30.0 mm	400 mm	19,10	1	9631-30-400
32.0 mm	400 mm	21,62	1	9631-32-400
35.0 mm	400 mm	19,69	1	9631-35-400
38.0 mm	400 mm	19,83	1	9631-38-400

Juego de 8 brocas planas para madera



9629-SET-8

X	g	€		
8	630 g	30,81	12	9629-SET-8

9629-12, 9629-16, 9629-18, 9629-20, 9629-22, 9629-25, 9629-28, 9629-32



Juego de brocas de punta perforadora para madera, 6 piezas



9656-SET-6

X	g	€		
6	720 g	65,31	1	9656-SET-6

Broca helicoidal para madera



9646

Ø	€		
3 mm	3,46	1	9646-3
4 mm	3,81	1	9646-4
5 mm	4,15	1	9646-5
6 mm	4,50	1	9646-6
7 mm	4,85	1	9646-7
8 mm	5,55	1	9646-8
9 mm	6,07	1	9646-9
10 mm	6,58	1	9646-10
11 mm	7,61	1	9646-11
12 mm	9,70	1	9646-12
13 mm	10,37	1	9646-13
14 mm	12,11	1	9646-14
15 mm	12,82	1	9646-15
16 mm	12,82	1	9646-16
18 mm	19,06	1	9646-18
20 mm	19,06	1	9646-20
6 mm	5,02	1	9646-6-250
8 mm	6,07	1	9646-8-250
10 mm	7,09	1	9646-10-250
12 mm	10,23	1	9646-12-250

Juego de 5 brocas para madera



9646-SET-5

X	g	€		
5	110 g	10,64	1	9646-SET-5

9646-4, 9646-5, 9646-6, 9646-8, 9646-10

Juego de 8 brocas para madera



9646-SET-8

X	g	€		
8	230 g	13,80	1	9646-SET-8

9646-3, 9646-4, 9646-5, 9646-6, 9646-7, 9646-8, 9646-9, 9646-10

Broca de diámetro variable



9528

Ø	€		
15-45 mm	40,34	10	9528-MD-15-45



Brocas para azulejos



4626

Ø	L	€	Icon	Icon
4 mm	58 mm	5,54	1	4626-4.0
5 mm	58 mm	6,10	1	4626-5.0
6 mm	58 mm	6,40	1	4626-6.0
8 mm	78 mm	7,64	1	4626-8.0
10 mm	98 mm	9,25	1	4626-10.0

Extensión 305mm cambio rápido



9625-6.35QC

Ø	L	€	Icon	Icon
6.35 mm	305 mm	27,11	1	9625-6.35QC

Punta diamante Grabber Phillips - 25 mm



63D/PH2G

Icon	Icon	€	Icon	Icon
5	PH2G	19,90	1	63D/PH2G

Brocas multiusos



4629

Ø	L	€	Icon	Icon
4.0 mm	75 mm	5,30	1	4629-4.0
5.0 mm	85 mm	5,55	1	4629-5.0
6.0 mm	100 mm	6,16	1	4629-6.0
8.0 mm	120 mm	7,40	1	4629-8.0
10.0 mm	120 mm	8,25	1	4629-10.0

Extensión de 330 mm para brocas de 3 puntas



9525

Ø	€	Icon	Icon
7 mm	14,62	1	9525-7
10 mm	18,60	1	9525-10

Punta diamante Pozidriv - 25 mm



63D/PZ

Icon	Icon	€	Icon	Icon
5	1	16,88	1	63D/PZ1
5	2	16,88	1	63D/PZ2

Juego de 5 brocas para multiusos con punta de carburo



4629-SET-5

Icon	g	€	Icon	Icon
5	165 g	35,55	10	4629-SET-5

4629-8.0, 4629-10.0, 4629-4.0, 4629-5.0, 4629-6.0

PUNTAS DESTORNILLADOR

Punta diamante Phillips - 25 mm



63D/PH

Icon	Icon	€	Icon	Icon
5	3	16,88	1	63D/PH3

Punta diamante Torx - 25 mm



63D/T

Icon	Icon	€	Icon	Icon
5	T10	19,30	1	63D/T10
5	T15	19,30	1	63D/T15
5	T40	19,30	1	63D/T40

Caja 5 Puntas Pozidriv de diamante, 50 mm



63D/50PZ

X	+	€		
5	1	26,53	1	63D/50PZ1
5	2	26,53	1	63D/50PZ2
5	3	26,53	1	63D/50PZ3

Punta de torsión TIN Pozidriv - 25 mm



62TIN/PZ

X	+	€		
10	1	20,51	1	62TIN/PZ1
10	2	20,51	1	62TIN/PZ2
10	3	20,51	1	62TIN/PZ3

Punta de torsión TIN Pozidriv - 50 mm



62TIN/50PZ

X	+	€		
5	1	22,30	1	62TIN/50PZ1
5	2	22,30	1	62TIN/50PZ2
5	3	22,30	1	62TIN/50PZ3

Juego de 6 puntas de diamante Phillips, Pozidriv, TORX® y adaptador



63D/7

X		€		
7	20 x 50 x 80 mm	28,85	1	63D/7-1

- 63D/PH2
- 63D/PZ2
- 63D/T10, 63D/T15, 63D/T25, 63D/T30

Punta de torsión TIN Torx - 25 mm



62TIN/T

X	+	€		
10	T15	25,32	1	62TIN/T15
10	T20	25,32	1	62TIN/T20
10	T25	25,32	1	62TIN/T25
10	T30	25,32	1	62TIN/T30

Juego de 6 puntas TIN Phillips, Pozidriv, TORX®



62TIN/7

X		€		
7	22 x 65 x 75 mm	22,95	1	62TIN/7-1

- 62TIN/PH2
- 62TIN/PZ2
- 62TIN/T15, 62TIN/T20, 62TIN/T25, 62TIN/T30

Punta de torsión TIN Phillips - 25 mm



62TIN/PH

X	+	€		
10	1	20,51	1	62TIN/PH1

Punta de torsión TIN Phillips - 50 mm



62TIN/50PH

X	+	€		
5	1	22,30	1	62TIN/50PH1
5	3	22,30	1	62TIN/50PH3

Punta de torsión Phillips ACR - 25 mm



64A/PH

X	+	€		
10	1	14,95	1	64A/PH1
10	3	14,95	1	64A/PH3



Punta de torsión Pozidriv ACR - 25 mm



64A/PZ

X	+	€		
10	1	14,95	1	64A/PZ1
10	3	14,95	1	64A/PZ3

Punta de torsión Phillips - 25 mm



60T/PH

X	+	€		
10	1	10,86	1	60T/PH1
10	2	10,86	1	60T/PH2
10	3	10,86	1	60T/PH3

Punta de torsión Pozidriv - 25 mm



60T/PZ

X	+	€		
10	1	10,86	1	60T/PZ1
10	2	10,86	1	60T/PZ2
10	3	10,86	1	60T/PZ3

Punta de torsión Torx - 25 mm



60T/T

X	+	€		
10	T7	16,88	1	60T/T7
10	T9	16,88	1	60T/T9
10	T15	16,88	1	60T/T15
10	T20	16,88	1	60T/T20
10	T25	16,88	1	60T/T25
10	T27	16,88	1	60T/T27
10	T40	16,88	1	60T/T40

Juego de 6 puntas de torsión Phillips, Pozidriv, TORX® y adaptador magnético



60T/7

X		€		
7	22 x 65 x 75 mm	17,59	1	60T/7-1

60T/PH2

60T/PZ2

60T/T10, 60T/T15, 60T/T20, 60T/T30

Juego de 17 puntas de torsión Phillips, Pozidriv, TORX® y adaptador magnético



60T/17

X		€		
17	27 x 73 x 82 mm	28,88	1	60T/17-1

60T/PH1, 60T/PH2

60T/T7, 60T/T8, 60T/T9, 60T/T10, 60T/T15x 2, 60T/T20x 2, 60T/T25x 2, 60T/T27, 60T/T30x 2, 60T/T40

Juego de puntas de impacto



60T/31

X		€		
31	42 x 65 x 110 mm	37,78	1	60T/31-1

59S/0.6-4.5, 59S/0.8-5.5

60T/PH1, 60T/PH2x 3, 60T/PH3

59S/PH2Gx 2

60T/PZ1, 60T/PZ2x 3, 60T/PZ3

60T/T10, 60T/T15x 3, 60T/T20x 3, 60T/T25x 2, 60T/T27, 60T/T30x 2

59S/H3, 59S/H4, 59S/H5, 59S/H6

Punta de torsión Phillips extra dura - 25 mm



61H/PH

X	+	€		
10	1	11,58	1	61H/PH1
10	2	11,58	1	61H/PH2
5	3	5,79	1	61H/PH3

Punta de torsión Phillips extra dura - 50 mm



61H/50PH

X	+	€		
5	1	14,72	1	61H/50PH1

Punta de torsión Torx extra dura - 50 mm



61H/50T

X	T	€		
5	T10	18,68	1	61H/50T10
5	T15	18,68	1	61H/50T15
5	T25	18,68	1	61H/50T25
5	T30	18,68	1	61H/50T30

Puntas de impacto 1/4" 25mm, Pozidriv



66IM/PZ

X	PZ	€		
2	1	3,05	1	66IM/PZ1-2P
2	2	3,05	1	66IM/PZ2-2P
2	3	3,05	1	66IM/PZ3-2P

Punta de torsión Pozidriv extra dura - 25 mm



61H/PZ

X	PZ	€		
5	3	5,79	1	61H/PZ3

Punta de torsión Torx extra dura - 25 mm



61H/T

X	T	€		
10	T10	17,83	1	61H/T10
10	T15	17,83	1	61H/T15
10	T20	17,83	1	61H/T20
10	T25	17,83	1	61H/T25
5	T40	8,93	1	61H/T40

Puntas de impacto 1/4" 25mm, Torx



66IM/T

X	T	€		
2	T10	3,14	1	66IM/T10C-2P
2	T15	3,14	1	66IM/T15C-2P
2	T20	3,14	1	66IM/T20C-2P
2	T25	3,14	1	66IM/T25C-2P
2	T27	3,14	1	66IM/T27C-2P
2	T20	3,14	1	66IM/T30C-2P
2	T40	3,14	1	66IM/T40C-2P

Punta de torsión Pozidriv extra dura - 50 mm



61H/50PZ

X	PZ	€		
5	1	14,72	1	61H/50PZ1
5	2	14,72	1	61H/50PZ2
5	3	14,72	1	61H/50PZ3

Puntas de impacto 1/4" 25mm, Phillips



66IM/PH

X	PH	€		
2	1	3,05	1	66IM/PH1-2P
2	2	3,05	1	66IM/PH2-2P
2	3	3,05	1	66IM/PH3-2P

Puntas de impacto 1/4" 50mm, Phillips



66IM/50PH

X	PH	€		
2	1	3,88	1	66IM/50PH1-2P
2	2	3,88	1	66IM/50PH2-2P
2	3	3,88	1	66IM/50PH3-2P



Puntas de impacto 1/4" 50mm, Pozidriv



66IM/50PZ

X	Icon	€	Icon	Icon
2	1	3,88	1	66IM/50PZ1-2P
2	2	3,88	1	66IM/50PZ2-2P
2	3	3,88	1	66IM/50PZ3-2P

Juego de 10 puntas de impacto 50mm



66IM/10C-1

X	Icon	€	Icon	Icon
10	10 x 50 x 140 mm	22,11	1	66IM/10C-1

66IM/50PH2-2Px 2, 66IM/50PH3-2P	Icon	Icon
66IM/50PZ2-2Px 2, 66IM/50PZ3-2P	Icon	Icon
66IM/50T20C-2Px 2, 66IM/50T25C-2P, 66IM/50T30C-2P	Icon	Icon

Puntas de impacto 1/4" 50mm, Torx



66IM/50TC

X	Icon	€	Icon	Icon
2	10	3,93	1	66IM/50T10C-2P
2	15	3,93	1	66IM/50T15C-2P
2	20	3,93	1	66IM/50T20C-2P
2	25	3,93	1	66IM/50T25C-2P
2	27	3,93	1	66IM/50T27C-2P
2	30	3,93	1	66IM/50T30C-2P
2	40	3,93	1	66IM/50T40C-2P

Punta estándar ranurada - 25 mm



Juego de 11 puntas de impacto de 25mm



66IM/11C-1

X	Icon	€	Icon	Icon
11	25 x 37 x 140 mm	17,68	1	66IM/11C-1

66IM/PH2-2Px 2, 66IM/PH3-2P	Icon	Icon
66IM/PZ2-2Px 2, 66IM/PZ3-2P	Icon	Icon
66IM/T20C-2Px 2, 66IM/T25C-2P, 66IM/T30C-2P	Icon	Icon
KMT753-QR-1P	Icon	Icon

59S/

X	Icon	€	Icon	Icon
10	3.0 mm	12,68	1	59S/0.5-3.0
3	3.0 mm	3,81	1	59S/0.5-3.0-3P
10	4.0 mm	12,68	1	59S/0.5-4.0
3	4.0 mm	3,81	1	59S/0.5-4.0-3P
10	3.5 mm	12,68	1	59S/0.6-3.5
3	3.5 mm	3,81	1	59S/0.6-3.5-3P
10	4.5 mm	12,68	1	59S/0.6-4.5
3	4.5 mm	3,81	1	59S/0.6-4.5-3P
10	5.5 mm	12,68	1	59S/0.8-5.5
3	5.5 mm	3,81	1	59S/0.8-5.5-3P
10	5.5 mm	12,68	1	59S/1.0-5.5
3	5.5 mm	3,81	1	59S/1.0-5.5-3P
10	6.5 mm	12,68	1	59S/1.2-6.5
3	6.5 mm	3,81	1	59S/1.2-6.5-3P
10	8.0 mm	20,60	1	59S/1.2-8.0
3	8.0 mm	6,19	1	59S/1.2-8.0-3P
10	9.0 mm	20,60	1	59S/1.6-9.0
10	10 mm	20,60	1	59S/1.6-10
3	9.0 mm	6,19	1	59S/1.6-9.0-3P
3	10.0 mm	6,19	1	59S/1.6-10-3P

Punta estándar Phillips - 25 mm



59S/PH

X	Icon	€	Icon	Icon
10	0	6,62	1	59S/PH0
3	0	2,54	1	59S/PH0-3P
3	1	3,31	1	59S/PH1-3P
30	1	18,56	1	59S/PH1-30P
100	*1	0,52	100	59S/PH1-IP
500	1	0,47	500	59S/PH1-IPB
10	2	6,62	1	59S/PH2
3	2	3,31	1	59S/PH2-3P
30	2	18,56	1	59S/PH2-30P
100	*2	0,52	100	59S/PH2-IP
500	*2	0,47	500	59S/PH2-IPB
3	3	3,31	1	59S/PH3-3P
30	3	18,56	1	59S/PH3-30P
500	3	0,47	500	59S/PH3-IPB
10	4	13,45	1	59S/PH4
3	4	4,32	1	59S/PH4-3P

Punta estándar Grabber Phillips - 25 mm



59S/PH2G

X	Icon	€	Icon	Icon
3	PH 2G	3,88	1	59S/PH2G-3P
30	PH2G	35,44	1	59S/PH2G-30P

Punta estándar Pozidriv - 25 mm



59S/PZ

X		€		
10	0	8,46	1	59S/PZ0
3	0	2,54	1	59S/PZ0-3P
10	1	6,62	1	59S/PZ1
3	1	3,31	1	59S/PZ1-3P
30	1	18,56	1	59S/PZ1-30P
100	*1	0,61	100	59S/PZ1-IP
500	*1	0,47	500	59S/PZ1-IPB
3	2	3,31	1	59S/PZ2-3P
30	2	18,56	1	59S/PZ2-30P
100	*2	0,52	100	59S/PZ2-IP
500	*2	0,47	500	59S/PZ2-IPB
10	3	6,62	1	59S/PZ3
3	3	3,31	1	59S/PZ3-3P
30	3	18,56	1	59S/PZ3-30P
500	3	0,47	500	59S/PZ3-IPB
10	4	13,45	1	59S/PZ4

Punta estándar Torx - 25 mm



59S/T

X		€		
5	T3	9,26	1	59S/T3
3	T3	5,55	1	59S/T3-3P
5	T4	9,26	1	59S/T4
3	T4	5,55	1	59S/T4-3P
5	T5	9,26	1	59S/T5
3	T5	5,55	1	59S/T5-3P
10	T6	11,11	1	59S/T6
3	T6	5,55	1	59S/T6-3P
10	T7	11,11	1	59S/T7
3	T7	5,55	1	59S/T7-3P
10	T8	11,11	1	59S/T8
3	T8	5,55	1	59S/T8-3P
10	T9	11,11	1	59S/T9
3	T9	5,55	1	59S/T9-3P
10	T10	11,11	1	59S/T10
3	T10	5,55	1	59S/T10-3P

X		€		
30	T10	30,91	1	59S/T10-30P
10	T15	10,00	1	59S/T15-10P
3	T15	5,55	1	59S/T15-3P
30	T15	30,91	1	59S/T15-30P
3	T20	5,55	1	59S/T20-3P
30	T20	30,91	1	59S/T20-30P
10	T25	11,11	1	59S/T25
3	T25	5,55	1	59S/T25-3P
30	T25	30,91	1	59S/T25-30P
10	T27	11,11	1	59S/T27
3	T27	5,55	1	59S/T27-3P
5	T30	10,00	1	59S/T30-10P
3	T30	7,43	1	59S/T30-3P
30	T30	34,49	1	59S/T30-30P
5	T40	12,38	1	59S/T40
3	T40	7,43	1	59S/T40-3P
30	T40	34,48	1	59S/T40-30P
3	T45	10,31	1	59S/T45-3P
5	T45	17,17	1	59S/T45-5P
5	T50	17,17	1	59S/T50
3	T50	10,31	1	59S/T50-3P

Puntas 1/4" Torx 25mm, 10 piezas



59S/TCS

X		€		
10	T10	9,00	1	59S/T10CS
10	T15	9,00	1	59S/T15CS
10	T20	9,00	1	59S/T20CS
10	T25	9,00	1	59S/T25CS
10	T27	9,00	1	59S/T27CS
10	T30	29,72	1	59S/T30CS
10	T40	29,72	1	59S/T40CS

Punta estándar Torx Tamper - 25 mm



59S/TR

X		€		
5	TR 7	13,62	1	59S/TR7
3	TR7	8,17	1	59S/TR7-3P

X		€		
5	TR 8	13,62	1	59S/TR8
3	TR8	8,17	1	59S/TR8-3P
5	TR 9	13,62	1	59S/TR9
3	TR9	8,17	1	59S/TR9-3P
5	TR 10	13,62	1	59S/TR10
3	TR 10	8,17	1	59S/TR10-3P
5	TR 15	13,62	1	59S/TR15
3	TR 15	8,17	1	59S/TR15-3P
5	TR 20	13,62	1	59S/TR20
3	TR 20	8,17	1	59S/TR20-3P
5	TR 25	13,62	1	59S/TR25
3	TR 25	8,17	1	59S/TR25-3P
5	TR 27	13,62	1	59S/TR27
3	TR 27	8,17	1	59S/TR27-3P
5	TR 30	13,62	1	59S/TR30
3	TR 30	8,17	1	59S/TR30-3P
5	TR 40	13,62	1	59S/TR40
3	TR 40	8,17	1	59S/TR40-3P

Punta estándar hexagonal métrica - 25 mm



59S/H mm

X		€		
5	1.5	13,19	1	59S/H1.5
3	1.5	7,93	1	59S/H1.5-3P
5	2	13,19	1	59S/H2
3	2	7,93	1	59S/H2-3P
5	2.5	13,19	1	59S/H2.5
3	2.5	7,93	1	59S/H2.5-3P
5	3	13,19	1	59S/H3
3	3	9,53	1	59S/H3-3P
5	4	13,19	1	59S/H4
3	4	9,53	1	59S/H4-3P
500	4	0,62	500	59S/H4-IPB
5	5	13,19	1	59S/H5
3	5	9,53	1	59S/H5-3P
5	6	13,19	1	59S/H6
3	6	9,53	1	59S/H6-3P
3	8	10,31	1	59S/H8-3P
5		17,17	1	59S/H8-5P
5	10	17,17	1	59S/H10
3	10	10,31	1	59S/H10-3P



Punta estándar hexagonal Imperial - 25 mm



59S/H "

X	Icon	€	Icon	Icon
3	1/16 in	7,93	1	59S/H1/16-3P
5	5/16 in	13,19	1	59S/H5/16-5P
3	5/64 in	7,93	1	59S/H5/64-3P
5	5/64 in	13,19	1	59S/H5/64-5P
3	3/32 in	7,93	1	59S/H3/32-3P
5	3/32 in	13,19	1	59S/H3/32-5P
3	7/64 in	7,93	1	59S/H7/64-3P
5	7/64 in	13,19	1	59S/H7/64-5P
3	1/8 in	7,93	1	59S/H1/8-3P
5	1/8 in	13,19	1	59S/H1/8-5P
3	9/64 in	7,93	1	59S/H9/64-3P
3	5/32 in	7,93	1	59S/H5/32-3P
5	5/32 in	13,19	1	59S/H5/32-5P
3	3/16 in	7,93	1	59S/H3/16-3P
5	3/16 in	13,19	1	59S/H3/16-5P
3	7/32 in	7,93	1	59S/H7/32-3P
5	7/32 in	13,19	1	59S/H7/32-5P
3	1/4 in	7,93	1	59S/H1/4-3P
5	1/4 in	13,19	1	59S/H1/4-5P
3	5/16 in	7,93	1	59S/H5/16-3P
3	3/8 in	10,31	1	59S/H3/8-3P
5	3/8 in	7,93	1	59S/H3/8-5P

Punta estándar Robertson - 25 mm



59S/R

X	Icon	€	Icon	Icon
10	# 1	29,07	1	59S/R1
3	# 1	11,64	1	59S/R1-3P
10	# 2	29,07	1	59S/R2
3	# 2	11,64	1	59S/R2-3P
10	# 3	29,07	1	59S/R3
3	# 3	11,64	1	59S/R3-3P
10	# 4	29,07	1	59S/R4

Caja 5 Puntas TORQ-SET®, 25 mm



59S/TS

X	€	Icon	Icon
5	0	36,33	1 59S/TS-0
5	1	36,33	1 59S/TS-1
5	2	36,33	1 59S/TS-2
5	3	36,33	1 59S/TS-3
5	4	36,33	1 59S/TS-4-5P
5	5	10,00	1 59S/TS-5-5P
5	6	36,33	1 59S/TS-6-5P
5	8	36,33	1 59S/TS-8-5P
5	10	36,33	1 59S/TS-10-5P

Puntas de impacto Torq-Set® -25 mm



59S/TS "

X	€	Icon	Icon
5	1/4"	36,33	1 59S/TS-1/4

Caja 5 Puntas Tri-Wing, 25 mm



59S/TW

X	Icon	€	Icon	Icon
5	TW 0	33,03	1	59S/TW0
5	TW 1	33,03	1	59S/TW1
5	TW 2	33,03	1	59S/TW2
5	TW 3	33,03	1	59S/TW3
5	TW 4	33,03	1	59S/TW4
5	TW 5	33,03	1	59S/TW5

Punta estándar XZN - 25 mm



59S/M

X	Icon	€	Icon	Icon
10	M3	34,36	1	59S/M3
3	M3	10,31	1	59S/M3-3P
10	M4	34,36	1	59S/M4
3	M4	10,31	1	59S/M4-3P
10	M5	34,36	1	59S/M5
3	M5	10,31	1	59S/M5-3P
10	M6	34,36	1	59S/M6
3	M6	10,31	1	59S/M6-3P
10	M8	38,31	1	59S/M8
3	M8	11,49	1	59S/M8-3P

Punta estándar ranurada - 50 mm



59S/50

X	Icon	€	Icon	Icon
5	3.5 mm	17,17	1	59S/50/0.6-3.5
5	4.0 mm	17,17	1	59S/50/0.8-4.0
5	5.5 mm	17,17	1	59S/50/0.8-5.5
5	6.0 mm	17,17	1	59S/50/1.0-6.0
5	6.5 mm	17,17	1	59S/50/1.2-6.5
2	3.5 mm	6,87	1	59S/50/3.5-2P
2	4.0 mm	6,87	1	59S/50/4.0-2P
2	5.5 mm	6,87	1	59S/50/5.5-2P
2	6.0 mm	6,87	1	59S/50/6.0-2P
2	6.5 mm	6,87	1	59S/50/6.5-2P

Punta estándar Phillips - 50 mm



59S/50PH

X	Icon	€	Icon	Icon
5	1	13,88	1	59S/50PH1
2	1	6,88	1	59S/50PH1-2P
5	2	8,75	1	59S/50PH2-5P
2	2	6,88	1	59S/50PH2-2P
2	3	6,88	1	59S/50PH3-2P
5	3	13,88	1	59S/50PH3-5P

Punta estándar Pozidriv - 50 mm



59S/50PZ

X	+	€		
2	1	6,88	1	59S/50PZ1-2P
2	2	6,88	1	59S/50PZ2-2P
5	2	13,88	1	59S/50PZ2-5P
2	3	6,88	1	59S/50PZ3-2P
5	3	13,88	1	59S/50PZ3-5P

Punta estándar Torx - 50 mm



59S/50T

X	*	€		
5	T 8	18,49	1	59S/50T8
2	T 8	9,78	1	59S/50T8-2P
5	T 10	18,49	1	59S/50T10
2	T 10	9,78	1	59S/50T10-2P
5	T 15	18,49	1	59S/50T15
2	T 15	9,78	1	59S/50T15-2P
5	T 20	9,30	1	59S/50T20-5P
2	T 20	9,78	1	59S/50T20-2P
5	T 25	18,49	1	59S/50T25
2	T 25	9,78	1	59S/50T25-2P
5	T 27	18,49	1	59S/50T27
5	T 30	18,49	1	59S/50T30
2	T 30	9,78	1	59S/50T30-2P
5	T 40	18,49	1	59S/50T40
2	T 40	9,78	1	59S/50T40-2P

Punta estándar métrica hexagonal - 50 mm



59S/50H

X	⬢	€		
5	2	21,14	1	59S/50H2
2	2	5,28	1	59S/50H2-2P
5	2.5	8,75	1	59S/50H2.5-5P
2	2.5	5,28	1	59S/50H2.5-2P

X	⬢	€		
5	3	21,14	1	59S/50H3
2	3	5,28	1	59S/50H3-2P
5	4	8,75	1	59S/50H4-5P
2	4	5,28	1	59S/50H4-2P
5	5	8,75	1	59S/50H5-5P
2	5	5,28	1	59S/50H5-2P
5	6	21,14	1	59S/50H6
2	6	5,28	1	59S/50H6-2P
2	8	5,28	1	59S/50H8-2P
5	8	21,14	1	59S/50H8-5P

Caja 5 Puntas hexagonales en pulgadas, 50 mm



59S/50H "

X	⬢	€		
5	1/1 in	20,48	1	59S/50H1/16
5	5/64 in	20,48	1	59S/50H5/64
5	3/32 in	20,48	1	59S/50H3/32
5	7/64 in	20,48	1	59S/50H7/64
5	1/8 in	20,48	1	59S/50H1/8
5	9/64 in	20,48	1	59S/50H9/64
5	5/32 in	20,48	1	59S/50H5/32
5	3/16 in	20,48	1	59S/50H3/16
5	7/32 in	20,48	1	59S/50H7/32
5	1/4 in	20,48	1	59S/50H1/4
5	5/16 in	20,48	1	59S/50H5/16
5	3/8 in	20,48	1	59S/50H3/8

Punta estándar Robertson - 50 mm



59S/50R

X	⬢	€		
5	#1	27,74	1	59S/50R1
2	#1	11,11	1	59S/50R1-2P
5	#2	27,74	1	59S/50R2
2	#2	11,11	1	59S/50R2-2P
5	#3	27,74	1	59S/50R3
2	#3	11,11	1	59S/50R3-2P

Punta estándar Phillips - 70 mm



59S/70PH

X	+	€		
2	1	9,25	1	59S/70PH1-2P
2	2	9,25	1	59S/70PH2-2P
5	2	23,12	1	59S/70PH2-5P

Punta estándar Pozidriv - 70 mm



59S/70PZ

X	+	€		
5	1	23,12	1	59S/70PZ1
2	1	9,25	1	59S/70PZ1-2P
5	2	23,12	1	59S/70PZ2
2	2	9,25	1	59S/70PZ2-2P
5	3	23,12	1	59S/70PZ3
2	3	9,25	1	59S/70PZ3-2P

Punta estándar Torx - 70 mm



59S/70T

X	*	€		
5	T10	27,74	1	59S/70T10
2	T10	11,11	1	59S/70T10-2P
5	T15	27,74	1	59S/70T15
2	T15	11,11	1	59S/70T15-2P
2	T20	11,11	1	59S/70T20-2P
5	T20	27,74	1	59S/70T20-5P
2	T25	11,11	1	59S/70T25-2P
5	T25	27,74	1	59S/70T25-5P
5	T27	27,74	1	59S/70T27
2	T27	11,11	1	59S/70T27-2P
2	T30	11,11	1	59S/70T30-2P
5	T30	27,74	1	59S/70T30-5P
5	T40	27,74	1	59S/70T40
2	T40	11,11	1	59S/70T40-2P



Punta estándar Torx Tamper - 70 mm



59S/70TR

X		€		
5	TR15	40,95	1	59S/70TR15
2	TR15	16,37	1	59S/70TR15-2P
5	TR20	40,95	1	59S/70TR20
2	TR20	16,37	1	59S/70TR20-2P
5	TR25	40,95	1	59S/70TR25
2	TR25	16,37	1	59S/70TR25-2P
5	TR27	40,95	1	59S/70TR27
2	TR27	16,37	1	59S/70TR27-2P
5	TR30	40,95	1	59S/70TR30
2	TR30	16,37	1	59S/70TR30-2P
5	TR40	40,95	1	59S/70TR40
2	TR40	16,37	1	59S/70TR40-2P

Punta estándar de bola hexagonal - 89 mm



59S/H BALL

X		€		
5	3	40,95	1	59S/H3BALL
2	3	16,37	1	59S/H3BALL-2P
5	4	40,95	1	59S/H4BALL
2	4	16,37	1	59S/H4BALL-2P
5	5	40,95	1	59S/H5BALL
2	5	16,37	1	59S/H5BALL-2P
5	6	40,95	1	59S/H6BALL
2	6	16,37	1	59S/H6BALL-2P
5	8	40,95	1	59S/H8BALL
2	8	16,37	1	59S/H8BALL-2P
3	5,6,8	24,51	1	59S/HBALL-3P

Punta estándar Phillips - 125 mm



59S/125PH

X		€		
5	1	34,36	1	59S/125PH1
2	1	13,74	1	59S/125PH1-2P
5	2	34,36	1	59S/125PH2
2	2	13,74	1	59S/125PH2-2P
100	2	2,58	100	59S/125PH2-1P
2	3	13,74	1	59S/125PH3-2P
5	3	34,36	1	59S/125PH3

Punta estándar Pozidriv - 125 mm



59S/125PZ

X		€		
5	1	34,36	1	59S/125PZ1
2	1	13,74	1	59S/125PZ1-2P
5	2	34,36	1	59S/125PZ2
2	2	13,74	1	59S/125PZ2-2P
5	3	34,36	1	59S/125PZ3
2	3	13,74	1	59S/125PZ3-2P

Bolsa 2 Puntas combi para terminales (boca recta/Phillips), 125mm



59S/PH COMBI

X		€		
2	5.0/PH1	16,37	1	59S/PH1COMBI-2P
2	6.0/PH2	16,37	1	59S/PH2COMBI-2P
2	8.0/PH3	16,37	1	59S/PH3COMBI-2P

Punta estándar Torx - 150 mm



59S/150T

X		€		
5	T15	51,53	1	59S/150T15
2	T15	20,61	1	59S/150T15-2P
5	T20	51,53	1	59S/150T20
2	T20	20,61	1	59S/150T20-2P
5	T25	51,53	1	59S/150T25
2	T25	20,61	1	59S/150T25-2P
5	T30	51,53	1	59S/150T30
2	T30	20,61	1	59S/150T30-2P

Puntas para tornillos hexagonales 7/16"



74S/H

X		€		
5	4 mm	42,45	1	74S/H4
2	4 mm	16,98	1	74S/H4-2P
5	5 mm	42,45	1	74S/H5
2	5 mm	16,98	1	74S/H5-2P
5	6 mm	42,45	1	74S/H6
2	6 mm	16,98	1	74S/H6-2P
5	7 mm	42,45	1	74S/H7
2	7 mm	16,98	1	74S/H7-2P
5	8 mm	42,45	1	74S/H8
2	8 mm	16,98	1	74S/H8-2P
5	10 mm	42,45	1	74S/H10
2	10 mm	16,98	1	74S/H10-2P
5	12 mm	56,56	1	74S/H12
2	12 mm	22,62	1	74S/H12-2P
5	14 mm	56,56	1	74S/H14
2	14 mm	22,62	1	74S/H14-2P
5	17 mm	56,56	1	74S/H17
2	17 mm	22,62	1	74S/H17-2P

Puntas para tornillos Phillips 5/32"



45S/PH

X		€		
5	1	16,89	1	45S/PH1
2	1	6,75	1	45S/PH1-2P
5	2	18,93	1	45S/PH2
2	2	7,57	1	45S/PH2-2P

Puntas para tornillos hexagonales 5/32"



45S/H

X		€		
5	1.5 mm	17,56	1	45S/H1.5
2	1.5 mm	7,02	1	45S/H1.5-2P
5	2 mm	17,56	1	45S/H2
2	2 mm	7,02	1	45S/H2-2P
5	2.5 mm	17,56	1	45S/H2.5
2	2.5 mm	7,02	1	45S/H2.5-2P
5	3 mm	17,56	1	45S/H3
2	3 mm	7,02	1	45S/H3-2P

Juego de 6 puntas Phillips, Pozidriv, TORX® y adaptador magnético



59S/7-1

X		€		
7	22 x 65 x 75 mm	12,39	1	59S/7-1

59S/PH1, 59S/PH2	+	
59S/PZ1, 59S/PZ2	+	
59S/T15, 59S/T20	+	

Juego de 6 puntas Phillips, TORX® y adaptador magnético



59S/7-2

X		€		
7	22 x 65 x 75 mm	13,08	1	59S/7-2

59S/PH2	+	
59S/T15x 2, 59S/T20x 2, 59S/T25	+	

Juego de 6 puntas TORX® Inviolable y adaptador magnético



59S/7-3

X		€		
7	22 x 65 x 75 mm	23,19	1	59S/7-3

59S/TR10, 59S/TR15, 59S/TR20, 59S/TR25, 59S/TR30, 59S/TR40	+	
--	---	--

Juego de 6 puntas TORX® y adaptador magnético



59S/7-4

X		€		
7	22 x 65 x 75 mm	13,54	1	59S/7-4

59S/T10, 59S/T15, 59S/T20, 59S/T25, 59S/T30, 59S/T40	+	
--	---	--

Juego de puntas 10 piezas para PH, Pozidriv y Torx



59S/10BC

X		€		
10	23 x 68 x 168 mm	4,52	1	59S/10BC

Juego de puntas Torx 11 piezas: 10 puntas y un adaptador magnético de liberación rápida



59S/TCS11-1

X		€		
11	108 x 68 x 31 mm	18,48	1	59S/TCS11-1

59S/T10CS, 59S/T15CS, 59S/T20CSx 3, 59S/T25CSx 2, 59S/T30CSx 2, 59S/T40CS	+	
KM653-QR-1P	+	

Juego de 16 puntas rectas, Phillips, Pozidriv



59S/17-1

X		€		
17	27 x 73 x 82 mm	21,69	1	59S/17-1

59S/0.5-3.0, 59S/0.6-4.5, 59S/0.8-5.5	+	
59S/PH1, 59S/PH2x 3	+	
59S/PH2Gx 2	+	
59S/PZ1, 59S/PZ2x 2	+	
59S/H3, 59S/H4, 59S/H5, 59S/H6	+	



Juego de 17 puntas TORX® y adaptador magnético



59S/17-2

		€		
17	27 x 73 x 82 mm	22,67	1	59S/17-2

59S/T7, 59S/T8, 59S/T9, 59S/T10, 59S/T15x 2, 59S/T20x 3, 59S/T25x 3, 59S/T27, 59S/T30x 2, 59S/T40

Juego de 17 puntas Pozidriv, Phillips y TORX® y adaptador magnético



59S/17-3

		€		
17	27 x 73 x 82 mm	21,99	1	59S/17-3

59S/PH1, 59S/PH2x 2

59S/PZ1, 59S/PZ2, 59S/PZ3

59S/T10, 59S/T15, 59S/T20, 59S/T25, 59S/T27, 59S/T30, 59S/T40

59S/H3, 59S/H4, 59S/H5

Juego de puntas de 22 piezas Boca recta, Phillips, Pozidriv, TORX® y adaptador para vasos 1/4"



59S/22-1

		€		
22	20 x 50 x 80 mm	30,77	1	59S/22-1

59S/0.5-3.0, 59S/0.6-4.5, 59S/0.8-5.5

59S/PH1, 59S/PH2, 59S/PH3

59S/PH2G

59S/PZ1, 59S/PZ2, 59S/PZ3

59S/T6, 59S/T8, 59S/T9, 59S/T10, 59S/T15, 59S/T20, 59S/T25, 59S/T27, 59S/T30, 59S/T40

K6650-1/4

Juego de 22 puntas Phillips, TORX, hexagonales,



59S/22-2

		€		
22	20 x 50 x 80 mm	30,77	1	59S/22-2

59S/PH2x 3

59S/PH2Gx 3

59S/PZ2x 2

59S/T10, 59S/T15x 4, 59S/T20x 3, 59S/T25x 2

59S/H2.5, 59S/H3

K6650-1/4

Juego de adaptador y 28 puntas, tornillos Ranurados



59S/28

		€		
28	30 x 58 x 110 mm	117,33	1	59S/28-4

59S/0.6-4.5, 59S/1.2-6.5, 59S/1.2-8.0

59S/PH1x 2, 59S/PH2x 2, 59S/PH3

59S/T6, 59S/T15

59S/H5/64, 59S/H3/32, 59S/H7/64, 59S/H1/8, 59S/H5/32, 59S/H3/16, 59S/H7/32, 59S/TS-4x 2, 59S/TS-6x 2, 59S/TS-8x 2, 59S/TS-10x 2, K6625-1/4, KM653

59S/H9/64

Juego de 31 puntas para tornillos ranurados, Phillips, Pozidriv, TORX® y hexagonales, porta puntas y adaptador de 1/4"



59S/31B

		€		
31	40.25 x 104.90 x 65.35 mm	15,71	1	59S/31B

1P: Envase unitario colgador plástico

59S/0.6-4.5, 59S/1.0-5.5

59S/PH1, 59S/PH2x 3, 59S/PH3

59S/PH2Gx 2

59S/PZ1, 59S/PZ2x 3, 59S/PZ3

59S/T10, 59S/T15x 3, 59S/T20x 3, 59S/T25x 2, 59S/T27, 59S/T30

59S/H3, 59S/H4, 59S/H5, 59S/H6

K6625-1/4-1P

KM653-QR-1P

Juego de 31 puntas para tornillos ranurados, Phillips, Pozidriv, TORX® y hexagonales, porta puntas y adaptador de 1/4"



59S/31B-IP

		€		
12	280 x 375 x 210 mm	15,40	12	59S/31B-IP

1P: Envase unitario colgador plástico
Se suministra en display de cartón al pedir 12 unidades

Juego de 31 puntas rectas, Phillips, Pozidriv TORX®, hexagonales y portapuntas magnético



59S/31-1

		€		
31	42 x 65 x 110 mm	24,04	1	59S/31-1

59S/0.5-3.0, 59S/0.6-4.5, 59S/0.8-5.5		
59S/PH1, 59S/PH2x 3, 59S/PH3		
59S/PH2Gx 2		
59S/PZ1, 59S/PZ2x 3, 59S/PZ3		
59S/T10, 59S/T15x 3, 59S/T20x 3, 59S/T25x 2, 59S/T27, 59S/T30		
59S/H3, 59S/H4, 59S/H5, 59S/H6		
66IM/KM75QR-1P		

Juego de 31 puntas Phillips, Pozidriv, TORX® y



59S/31-2

		€		
31	42 x 65 x 110 mm	24,72	1	59S/31-2

59S/PH2x 4		
59S/PH2Gx 4		
59S/PZ2x 4		
59S/TR10x 2, 59S/TR15x 4, 59S/TR20x 5, 59S/TR25x 5, 59S/TR30x 2		
KM653-QR-1P		

Juego de 31 puntas Phillips, Pozidriv, TORX® inviolables y adaptador magnético



59S/31-3

		€		
31	42 x 65 x 110 mm	28,88	1	59S/31-3

59S/PH1x 2, 59S/PH2x 2, 59S/PH3		
59S/PZ1x 2, 59S/PZ2x 2, 59S/PZ3		
59S/TR10x 2, 59S/TR15x 3, 59S/TR20x 5, 59S/TR25x 4, 59S/TR27, 59S/TR30x 4, 59S/TR40		
KM653-QR-1P		

Juego de puntas 35 piezas: 29 puntas, 4 adaptadores magnéticos, 1 porta puntas magnético liberación rápida, 1 adaptador



59/S35BC

		€		
35	50 x 110 x 180 mm	64,35	1	59/S35BC

Juego de puntas de 54 piezas para tornillos ranurados, Phillips, Pozidriv, TORX®, TORX® Tamper, Hexagonales y Robertson



59/S54BC

		€		
54	50 x 110 x 184 mm	34,56	1	59/S54BC

Juego de puntas de 54 piezas para tornillos ranurados, Phillips, Pozidriv, TORX®, TORX® Tamper, Hexagonales y Robertson



59/S54BC-IP

		€		
54	300 x 190 x 280 mm	34,56	8	59/S54BC-IP

Puntas Torx con código de colores
Se suministra en display de cartón al pedir 8 unidades

Juego de puntas de 100 piezas para tornillos ranurados, Phillips, Pozidriv, TORX®, TORX® Tamper, Hexagon, Robertson



59/S100BC

		€		
100	50 x 110 x 184 mm	45,25	1	59/S100BC

Juego de puntas de 100 piezas para tornillos ranurados, Phillips, Pozidriv, TORX®, TORX® Tamper, Hexagon, Robertson



59/S100BC-IP

		€		
100	300 x 190 x 280 mm	45,25	8	59/S100BC-IP

Puntas Torx con código de colores
Se suministra en display de cartón al pedir 8 unidades



Juego de 18 puntas, 5 vasos, carraca para puntas y adaptadores



2058/S26

QTY	Dimensions	Price	Accessories
26	80 x 100 x 35 mm	37,76	1 2058/S26
26	35 x 85 x 105 mm	35,15	1 SB-2058/S26

SB: Embalaje en blister con información del producto

Model	Icon	Image
2058-BR		
K6625-1/4-1P		
59S/H6, 59S/H5, 59S/H4, 59S/H3		
59S/T15, 59S/T10, 59S/T30, 59S/T25, 59S/T20		
59S/PZ3, 59S/PZ1, 59S/PZ2		
59S/PH1, 59S/PH2, 59S/PH3		
59S/0.8-5.5, 59S/0.5-4.0		
6700SM-8, 6700SM-7, 6700SM-6, 6700SM-13, 6700SM-10		
59S/1.0-6.0-1P		
KM753-QR-1P		

Juego de puntas y vasos estándar de 1/4" para tornillo de cabeza ranurada/ Phillips/ Pozidriv/TORX®/Hex - 26 piezas



2058/S26AF

QTY	Dimensions	Price	Accessories
26	80 x 100 x 35 mm	24,22	1 2058/S26AF

Juego de puntas con puntas, vasos, carraca para puntas y adaptadores, 26 piezas



2058/S26-2

QTY	Dimensions	Price	Accessories
1	80 x 100 x 35 mm	37,77	1 2058/S26-2

Model	Icon	Image
2058-BR		
6700SM-8, 6700SM-7, 6700SM-6, 6700SM-5, 6700SM-4		
K6625-1/4B-1P, KM653-QR-1P		
59S/0.5-3.0, 59S/0.8-5.5, 59S/0.5-4.0		
59S/T8, 59S/T7, 59S/T6, 59S/T5, 59S/T4		
59S/PZ1, 59S/PZ0, 59S/PZ2		
59S/H2, 59S/H2.5, 59S/H1.5, 59S/H3		
59S/PH1, 59S/PH0, 59S/PH2		

5 puntas PH2 25mm en envase tipo "boli"



59S/PH2PEN

QTY	Dimensions	Price	Accessories
5	13 x 17 x 132 mm	3,07	1 59S/PH2PEN

5 puntas PZ2 25mm en envase tipo "boli"



59S/PZ2PEN

QTY	Dimensions	Price	Accessories
5	13 x 17 x 132 mm	3,07	1 59S/PZ2PEN

5 puntas TORX en envase tipo "boli"



59S/TORXPEN

QTY	Dimensions	Price	Accessories
5	13 x 17 x 132 mm	3,58	1 59S/T15PEN
5	13 x 17 x 132 mm	3,58	1 59S/T20PEN
5	13 x 17 x 132 mm	3,58	1 59S/T25PEN

Dispensador 60 puntas en envase tipo "boli"



59S/60PEN/DISP

QTY	Dimensions	Price	Accessories
60	140 x 125 x 215 mm	184,31	1 59S/60PEN/DISP

59S/T15PENx 5, 59S/T20PENx 30, 59S/T25PENx 5		
59S/PH2PENx 10		
59S/PZ2PENx 10		

Puntas para tornillos ranurados



70S/

QTY	Dimensions	Price	Accessories
2	8.0 mm	8,38	1 70S/1.2-8.0-2P
5	9.0 mm	20,95	1 70S/1.6-9.0
2	9.0 mm	8,38	1 70S/1.6-9.0-2P
5	10.0 mm	29,75	1 70S/1.6-10.0
2	10.0 mm	11,90	1 70S/1.6-10.0-2P

		€		
5	12.0 mm	32,51	1	70S/2.0-12.0
2	12.0 mm	13,00	1	70S/2.0-12.0-2P
5	14.0 mm	36,68	1	70S/2.5-14.0
2	14.0 mm	14,68	1	70S/2.5-14.0-2P

Puntas para tornillos Phillips



70S/PH

		€		
5	1	18,41	1	70S/PH1
2	1	7,37	1	70S/PH1-2P
5	2	18,41	1	70S/PH2
2	2	7,37	1	70S/PH2-2P
5	3	18,41	1	70S/PH3
2	3	7,37	1	70S/PH3-2P
5	4	18,41	1	70S/PH4
2	4	7,37	1	70S/PH4-2P

Puntas para tornillos Pozidriv®



70S/PZ

		€		
5	1	18,41	1	70S/PZ1
2	1	7,37	1	70S/PZ1-2P
5	2	18,41	1	70S/PZ2
2	2	7,37	1	70S/PZ2-2P
5	3	18,41	1	70S/PZ3
2	3	7,37	1	70S/PZ3-2P
5	4	18,41	1	70S/PZ4
2	4	7,37	1	70S/PZ4-2P

Puntas para tornillos TORX® 5/16", 35mm



70S/T

		€		
5	T25	23,08	1	70S/T25-5P
5	T20	23,08	1	70S/T20
2	T20	9,23	1	70S/T20-2P

		€		
2	T25	9,23	1	70S/T25-2P
5	T27	10,75	1	70S/T27-5P
2	T27	9,23	1	70S/T27-2P
5	T30	23,08	1	70S/T30
2	T30	9,23	1	70S/T30-2P
2	T40	9,23	1	70S/T40-2P
5	T45	23,08	1	70S/T45
2	T45	9,23	1	70S/T45-2P
5	T50	23,08	1	70S/T50
2	T50	9,23	1	70S/T50-2P
5	T55	31,94	1	70S/T55
2	T55	12,76	1	70S/T55-2P

Puntas para tornillos Torque-set®



70S/TS

	€			
5	8 mm	43,13	1	70S/TS8
2	8 mm	17,25	1	70S/TS8-2P
5	10 mm	43,13	1	70S/TS10
2	10 mm	17,25	1	70S/TS10-2P

Puntas de impacto Torq-Set® -32 mm



70S/TS''

	€			
5	1/4"	38,46	1	70S/TS1/4
2	1/4"	15,38	1	70S/TS1/4-2P
5	5/16"	43,13	1	70S/TS5/16
2	5/16"	17,25	1	70S/TS5/16-2P

Puntas para tornillos Hexagonales



70S/H

		€		
5	4 mm	18,41	1	70S/H4
2	4 mm	7,37	1	70S/H4-2P
5	5 mm	18,41	1	70S/H5
2	5 mm	7,37	1	70S/H5-2P
5	6 mm	18,41	1	70S/H6
2	6 mm	7,37	1	70S/H6-2P
5	7 mm	18,41	1	70S/H7
2	7 mm	7,37	1	70S/H7-2P
5	8 mm	8,72	1	70S/H8-5P
2	8 mm	7,37	1	70S/H8-2P
5	10 mm	22,26	1	70S/H10
2	10 mm	8,90	1	70S/H10-2P
5	12 mm	23,71	1	70S/H12
2	12 mm	9,47	1	70S/H12-2P
5	14 mm	23,71	1	70S/H14
2	14 mm	9,47	1	70S/H14-2P

Destornillador de impacto 1/2" para puntas 5/16"



5521

	€		
125 mm	53,14	1	5521

Adaptador para puntas de destorgolpe



54640

	€		
40 mm	19,58	1	54640

Cuadrado 1/2" Para puntas 5/16" Para destornillador ref. 5521



Juego de puntas y destornillador a golpe cuadrado 1/2"



7823

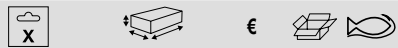

23 45 x 70 x 197 mm 75,46 1 7823

22 Puntas 5/16" (3 boca recta, 3 phillips, 8 hex, 8 Torx®)

5521	
54640	
70S/1.2-8.0, 70S/1.6-10.0, 70S/2.0-12.0	
70S/PH2, 70S/PH3, 70S/PH4	
70S/T20, 70S/T25, 70S/T27, 70S/T30, 70S/T40, 70S/T45, 70S/T50, 70S/T55	
70S/H4, 70S/H5, 70S/H6, 70S/H7, 70S/H8, 70S/H10, 70S/H12, 70S/H14	

Juego de destornillador a golpe con puntas: Recta, Phillips®, Pozidriv®, Torx®, hexagonales y adaptador



7865

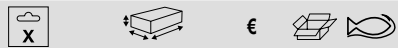

15 55 x 90 x 220 mm 43,82 1 7865

2 puntas rectas (5,6mm) incluidas en el juego. Incluye 1 adaptador (hexagonal 5/16" a 3/8") y 2 puntas ranuradas (5,6 mm)

5521	
54640	
70S/1.2-8.0, 70S/1.6-10.0	
70S/PH1, 70S/PH2, 70S/PH3, 70S/PH4	
70S/H4, 70S/H5, 70S/H6, 70S/H8	

Punta Phillips con rosca



K18

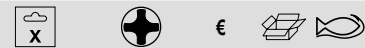

1	2	7,54	1	K18NF-2
1	2	8,37	1	K18PH-2M5
1	2	8,41	1	K18PH-2M6

Punta Pozidriv con rosca



K19PZD-2NF

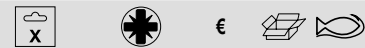

1	2	7,54	1	K19PZD-2NF
1	2	7,54	1	K19PZD-2M5

Punta TORX® con rosca



K20TORX



1	T25	10,66	1	K20TORX-T25
---	-----	-------	---	-------------

Adaptador, 50 mm



K6750



1	1/4 in	6,08	1	K6750-6
1	1/4 in	6,08	1	K6750-7
1	1/4 in	6,08	1	K6750-10-1P
1	1/4 in	6,08	1	K6750-13
1	1/4 in	6,08	1	K6750-1/4
1	1/4 in	6,08	1	K6750-3/8

Adaptador magnético, 50 mm



KM6750

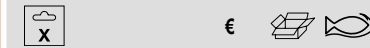

1		7,41	1	KM6750-6
1		7,41	1	KM6750-7
1		7,41	1	KM6750-10-1P
1		7,41	1	KM6750-11
1		7,41	1	KM6750-13-1P
1		7,41	1	KM6750-1/4
1		7,41	1	KM6750-3/8

Caja 5 Adaptadores con imán con sistema de ajuste rápido, 60mm



KM653-QR



1	1/4"	15,31	1	KM653-QR-1P
5	1/4"	65,95	1	KM653-QR-5P

KM653-QR-1P Envase unitario

Adaptador de ajuste rápido magnético, 75 mm



KM753-QR

		€		
1	1/4 in	17,17	1	KM753-QR-1P

Porta puntas torsión 75mm



KMT753-QR-1P

		€		
1/4 in	1/4 in	10,23	1	KMT753-QR-1P

Caja 5 Adaptadores universales magnéticos de 1/4" con anilla de retención 75mm



KMR753

		€		
1	1/4 in	8,23	1	KMR753-1P
5	1/4 in	41,22	1	KMR753

-1P: Envase unitario en soporte plástico

Caja 5 Adaptadores universales de 1/4" con anilla de retención, 60 mm



KR653

		€		
1	1/4 in	5,84	1	KR653-1P
5	1/4 in	29,19	1	KR653

Adaptador angular de 1/4"



KM653-SF

		€		
1	1/4" in	17,87	1	KM653-SF

Adaptador universal de 1/4" de cobre-berilio



KCB753

		€		
1	1/4 in	46,16	1	KCB753

Caja 5 Adaptadores con imán sin anillo interno



KM653

		€		
1	1/4"	6,00	1	KM653-1P
5	1/4"	30,02	1	KM653-5P

KM653-1P Envase unitario

Caja 5 Adaptadores universales magnéticos de 1/4" con anilla de retención 60mm



KMR653

		€		
1	1/4 in	8,99	1	KMR653-1P
5	1/4 in	25,93	1	KMR653-5P

-1P: Envase unitario en soporte plástico

Caja 5 Adaptadores universales magnéticos de 1/4" con anilla de retención 150mm



KMR150

		€		
1	1/4 in	15,79	1	KMR150-1P
5	1/4 in	68,69	1	KMR150

-1P: Envase unitario en soporte plástico



Adaptador magnético para puntas 5/16"



KM1/4-5/16-1P

Icon	Hexagon	€	Box	Weight
X	1/4 in	6,79	1	KM1/4-5/16-1P

Caja 5 Adaptadores hexágono 1/4" y cuadrado 1/4", 25mm



K6625

Icon	Hexagon	€	Box	Weight
X	1/4 in	5,29	1	K6625-1/4-1P
		26,45	1	K6625-1/4B-5P

-1P: Envase unitario en soporte plástico

Caja 5 Adaptadores cuadrado 1/4" y hexágono 3/8" 38mm



K6638

Icon	Hexagon	€	Box	Weight
X	1/4 in	6,19	1	K6638-3/8-1P
	1/4 in	30,91	1	K6638-3/8

1P: Envase unitario soporte plástico

Caja 5 adaptadores hexágono y cuadrado, 50 mm



K6650

Icon	Hexagon	€	Box	Weight
X		8,74	1	K6650-1/4B-1P
		43,61	1	K6650-1/4P-5P
	1/4 in	11,68	1	K6650-3/8-1P
		58,40	1	K6650-3/8P-5P
	1/4 in	14,42	1	K6650-1/2-1P
		72,14	1	K6650-1/2P-5P

-1P: Envase unitario en soporte plástico Con pivote (excepto K6650-1/4-1P con bola)

Caja 5 Adaptadores hexágono y cuadrado, 100 mm



K66100

Icon	Hexagon	€	Box	Weight
X	1/4 in	10,86	1	K66100-1/4-1P
	1/4 in	54,27	1	K66100-1/4
	1/4 in	13,74	1	K66100-3/8-1P
	1/4 in	68,69	1	K66100-3/8

K66100-1/4 con pivote K66100-3/8 con bola 1P: Envase unitario soporte plástico

Adaptador de ajuste rápido de 1/4", 60 mm



K6660-QR

Icon	Hexagon	€	Box	Weight
X	1/4 in	14,15	1	K6660-QR-1P

HERRAMIENTAS DE IMPACTO

Vaso de impacto hexagonal 1/4"



K6701M

Hexagon	€	Box	Weight
6 mm	7,35	1	K6701M-6
7 mm	7,35	1	K6701M-7
8 mm	7,39	1	K6701M-8
9 mm	7,39	1	K6701M-9
10 mm	7,39	1	K6701M-10
11 mm	7,39	1	K6701M-11
12 mm	9,21	1	K6701M-12
13 mm	9,21	1	K6701M-13
14 mm	9,21	1	K6701M-14

Vasos de impacto hexagonales, mm, 1/4", en clip



SBK6701M

Hexagon	€	Box	Weight
6 mm	7,35	1	SBK6701M-6
7 mm	7,35	1	SBK6701M-7
8 mm	7,35	1	SBK6701M-8
9 mm	7,35	1	SBK6701M-9
10 mm	7,35	1	SBK6701M-10
11 mm	7,35	1	SBK6701M-11
12 mm	9,11	1	SBK6701M-12
13 mm	9,11	1	SBK6701M-13
14 mm	9,11	1	SBK6701M-14

Vaso impacto 1/4" magnético



KM6701M

Ø	€		
7 mm	31,56	1	KM6701M-7
8 mm	31,95	1	KM6701M-8
10 mm	32,96	1	KM6701M-10

Muelle de fijación



K560F-1

Ø	Ø	€	
1/4 in	6-14 mm	3,24	5 K560F-1

Vaso de impacto hexagonal 3/8", mm



K7401M

Ø	€		
7 mm	8,70	1	K7401M-7
8 mm	8,70	1	K7401M-8
9 mm	8,70	1	K7401M-9
10 mm	8,70	1	K7401M-10
11 mm	8,70	1	K7401M-11
12 mm	8,70	1	K7401M-12
13 mm	8,70	1	K7401M-13
14 mm	8,70	1	K7401M-14
15 mm	8,70	1	K7401M-15
16 mm	8,70	1	K7401M-16
17 mm	8,70	1	K7401M-17
18 mm	10,34	1	K7401M-18

Ø	€		
19 mm	10,34	1	K7401M-19
20 mm	10,63	1	K7401M-20
21 mm	10,63	1	K7401M-21
22 mm	11,12	1	K7401M-22
24 mm	11,29	1	K7401M-24

Vasos de impacto hexagonales, mm, 3/8", en clip



SBK7401M

Ø	€		
7 mm	8,41	1	SBK7401M-7
8 mm	8,41	1	SBK7401M-8
9 mm	8,41	1	SBK7401M-9
10 mm	8,41	1	SBK7401M-10
11 mm	8,41	1	SBK7401M-11
12 mm	8,41	1	SBK7401M-12
13 mm	8,41	1	SBK7401M-13
14 mm	8,41	1	SBK7401M-14
15 mm	8,41	1	SBK7401M-15
16 mm	8,41	1	SBK7401M-16
17 mm	8,41	1	SBK7401M-17
18 mm	9,88	1	SBK7401M-18
19 mm	9,88	1	SBK7401M-19
20 mm	10,17	1	SBK7401M-20
21 mm	10,17	1	SBK7401M-21
22 mm	10,62	1	SBK7401M-22
24 mm	10,71	1	SBK7401M-24

Vaso de impacto serie larga 3/8", mm



K7406M

Ø	€		
10 mm	9,73	1	K7406M-10
13 mm	11,05	1	K7406M-13
17 mm	12,05	1	K7406M-17

Vaso de impacto hexagonal 3/8", en pulgadas



K7401Z

Ø	€		
3/8 in	9,17	1	K7401Z-3/8
7/16 in	9,17	1	K7401Z-7/16
1/2 in	9,17	1	K7401Z-1/2
9/16 in	9,17	1	K7401Z-9/16
5/8 in	9,17	1	K7401Z-5/8
11/16 in	9,17	1	K7401Z-11/16
3/4 in	9,17	1	K7401Z-3/4
13/16 in	9,17	1	K7401Z-13/16
7/8 in	9,17	1	K7401Z-7/8

Adaptador de impacto de 3/8" para puntas de 1/4"



K172

Ø	€		
1/4"	32,66	1	K172

Adaptador de impacto portapuntas 3/8"



7407H-7409H

Ø	Ø	€	
1/4"	3/8"	25,23	1 7407H
5/16"	3/8"	25,23	1 7408H
11	3/8"	29,24	1 7409H



Vaso de impacto 3/8" TORX®



K7401TORX-E

Icon	Icon	€	Icon	Icon
E5	M4	11,42	1	K7401TORX-E5
E6	M5	11,42	1	K7401TORX-E6
E7	M6	11,42	1	K7401TORX-E7
E8	M6, M7	11,42	1	K7401TORX-E8
E10	M6, M8	11,42	1	K7401TORX-E10
E12	M8, M10	11,42	1	K7401TORX-E12
E14	M10, M12	11,42	1	K7401TORX-E14

Vaso de impacto giratorio hexagonal 3/8", mm



KS7401M

Icon	€	Icon	Icon
3/8 in	33,54	1	KS7401M-9
3/8 in	33,54	1	KS7401M-10
3/8 in	33,54	1	KS7401M-11
3/8 in	33,54	1	KS7401M-12
3/8 in	33,54	1	KS7401M-13
3/8 in	34,67	1	KS7401M-14
3/8 in	34,67	1	KS7401M-15
3/8 in	34,67	1	KS7401M-16
3/8 in	34,67	1	KS7401M-17
3/8 in	34,67	1	KS7401M-18
3/8 in	34,67	1	KS7401M-19
3/8 in	37,42	1	KS7401M-22

Articulación universal de impacto 3/8"



K7767S

Icon	Icon	€	Icon	Icon
3/8"	3/8"	33,88	1	K7767S

Reductor/Amplificador de impacto 3/8"



K6964C

Icon	Icon	€	Icon	Icon
1/4"	3/8"	23,20	1	K6964C

Este producto no está garantizado contra la rotura del cuadrado macho

Adaptadores con cuadrado de 3/8" con acabado fosfatado



K8164C

Icon	Icon	€	Icon	Icon
1/2"	3/8"	23,20	1	K8164C

Alargadera de impacto 3/8"



K7760C

Icon	€	Icon	Icon
75 mm	16,02	1	K7760C-1
150 mm	23,03	1	K7760C-2

Muelle de fijación



K560F-2/3

Icon	Icon	€	Icon	Icon
3/8"	7-12	3,24	5	K560F-2
3/8"	13-24	3,24	5	K560F-3

Juego de vasos de impacto, 10 piezas



K7401M/10

Icon	€	Icon	Icon
10	86,46	1	K7401M/10

K7401M-10, K7401M-11, K7401M-12, K7401M-13, K7401M-14, K7401M-15, K7401M-16, K7401M-17, K7401M-18, K7401M-19



Juego de 7 vasos de impacto 3/8" E TORX®



K7401TORX-E-S7



	€	SB	SBK
7	79,96	1	K7401TORX-E-S7

K7401TORX-E5, K7401TORX-E6, K7401TORX-E7, K7401TORX-E8, K7401TORX-E10, K7401TORX-E12, K7401TORX-E14

Vaso de impacto hexagonal 1/2" mm, ultracorto



K7800M

Ø	€	SB	SBK
10 mm	6,35	1	K7800M-10
11 mm	6,35	1	K7800M-11
12 mm	6,35	1	K7800M-12
13 mm	6,35	1	K7800M-13
14 mm	6,46	1	K7800M-14
15 mm	6,46	1	K7800M-15
16 mm	6,46	1	K7800M-16
17 mm	6,75	1	K7800M-17
18 mm	6,75	1	K7800M-18
19 mm	6,75	1	K7800M-19
21 mm	6,75	1	K7800M-21
22 mm	6,86	1	K7800M-22
24 mm	7,42	1	K7800M-24

Vaso de impacto 1/2", hexagonal



K7801M

Ø	€	SB	SBK
8 mm	6,08	1	K7801M-8
9 mm	6,08	1	K7801M-9
10 mm	10,29	1	K7801M-10
11 mm	10,29	1	K7801M-11
12 mm	10,29	1	K7801M-12
13 mm	10,29	1	K7801M-13
14 mm	10,65	1	K7801M-14
15 mm	10,86	1	K7801M-15
16 mm	10,86	1	K7801M-16
17 mm	11,37	1	K7801M-17
18 mm	11,37	1	K7801M-18
19 mm	11,37	1	K7801M-19
20 mm	11,99	1	K7801M-20
21 mm	12,06	1	K7801M-21
22 mm	12,20	1	K7801M-22
23 mm	12,57	1	K7801M-23
24 mm	12,76	1	K7801M-24
25 mm	14,77	1	K7801M-25
26 mm	15,18	1	K7801M-26
27 mm	15,18	1	K7801M-27
28 mm	15,18	1	K7801M-28
29 mm	15,34	1	K7801M-29
30 mm	18,60	1	K7801M-30
32 mm	26,64	15	K7801M-32
34 mm	30,09	1	K7801M-34
36 mm	31,10	1	K7801M-36

Vasos de impacto hexagonales, mm, 1/2", en clip



SBK7801M

Ø	€	SB	SBK
8 mm	7,98	1	SBK7801M-8
9 mm	7,98	1	SBK7801M-9
10 mm	10,05	1	SBK7801M-10
11 mm	10,05	1	SBK7801M-11

Ø	€	SB	SBK
12 mm	10,05	1	SBK7801M-12
13 mm	10,05	1	SBK7801M-13
14 mm	10,40	1	SBK7801M-14
15 mm	10,40	1	SBK7801M-15
16 mm	10,40	1	SBK7801M-16
17 mm	11,38	1	SBK7801M-17
18 mm	11,38	1	SBK7801M-18
19 mm	11,38	1	SBK7801M-19
20 mm	11,38	1	SBK7801M-20
21 mm	11,38	1	SBK7801M-21
22 mm	12,20	1	SBK7801M-22
23 mm	12,24	1	SBK7801M-23
24 mm	12,24	1	SBK7801M-24
25 mm	12,24	1	SBK7801M-25
26 mm	12,24	1	SBK7801M-26
27 mm	15,20	1	SBK7801M-27
28 mm	14,55	1	SBK7801M-28
29 mm	14,63	1	SBK7801M-29
30 mm	16,53	1	SBK7801M-30
32 mm	23,69	1	SBK7801M-32
34 mm	25,75	1	SBK7801M-34
36 mm	25,75	1	SBK7801M-36

Vaso de impacto serie larga 1/2", hexagonal



K7806M

Ø	€	SB	SBK
10 mm	12,54	1	K7806M-10
11 mm	12,54	1	K7806M-11
12 mm	12,54	1	K7806M-12
13 mm	12,54	1	K7806M-13
14 mm	12,54	1	K7806M-14
15 mm	12,68	1	K7806M-15
16 mm	12,68	1	K7806M-16
17 mm	12,68	1	K7806M-17
18 mm	12,72	1	K7806M-18
19 mm	12,72	1	K7806M-19
21 mm	12,72	1	K7806M-21
22 mm	12,72	1	K7806M-22
23 mm	13,31	1	K7806M-23
24 mm	13,13	1	K7806M-24
27 mm	15,32	1	K7806M-27
30 mm	17,32	1	K7806M-30
32 mm	20,23	1	K7806M-32
36 mm	23,42	1	K7806M-36

SB: Embalaje en blister con información del producto



Vaso de impacto largo 1/2" hexagonal en mm, con acabado fosfatado



SBK7806M

Ø	€		
10 mm	13,15	1	SBK7806M-10
11 mm	13,15	1	SBK7806M-11
12 mm	13,15	1	SBK7806M-12
13 mm	13,15	1	SBK7806M-13
14 mm	13,15	1	SBK7806M-14
15 mm	13,30	1	SBK7806M-15
16 mm	13,30	1	SBK7806M-16
17 mm	13,30	1	SBK7806M-17
18 mm	13,34	1	SBK7806M-18
19 mm	13,34	1	SBK7806M-19
21 mm	13,34	1	SBK7806M-21
22 mm	13,34	1	SBK7806M-22
23 mm	13,93	1	SBK7806M-23
24 mm	13,75	1	SBK7806M-24
27 mm	15,93	1	SBK7806M-27
30 mm	17,94	1	SBK7806M-30
32 mm	20,85	1	SBK7806M-32
36 mm	24,04	1	SBK7806M-36

Vasos de impacto 1/2", hexagonal, pulgadas



K7801Z

Ø	€		
3/8 in	10,36	1	K7801Z-3/8
7/16 in	10,36	1	K7801Z-7/16
1/2 in	10,36	1	K7801Z-1/2
9/16 in	10,73	1	K7801Z-9/16
5/8 in	10,73	1	K7801Z-5/8
11/16 in	10,73	1	K7801Z-11/16
3/4 in	10,74	1	K7801Z-3/4
13/16 in	10,89	1	K7801Z-13/16
7/8 in	10,89	1	K7801Z-7/8
15/16 in	12,78	1	K7801Z-15/16
1 in	13,35	1	K7801Z-1
1 1/16 in	14,45	1	K7801Z-1.1/16
1 1/8 in	15,37	1	K7801Z-1.1/8
1 1/4 in	25,73	1	K7801Z-1.1/4
1 5/16 in	29,88	5	K7801Z-1.5/16
1 3/8 in	29,88	5	K7801Z-1.3/8
1 7/16 in	29,88	5	K7801Z-1.7/16
1 1/2 in	34,36	5	K7801Z-1.1/2

Ø	€		
1 7/16 in	30,28	1	SBK7801Z-1.7/16
1 1/2 in	34,69	1	SBK7801Z-1.1/2

Vasos de impacto 1/2", serie larga, pulgadas



K7806Z

Ø	€		
3/8 in	13,78	10	K7806Z-3/8
7/16 in	13,78	5	K7806Z-7/16
1/2 in	13,78	10	K7806Z-1/2
9/16 in	13,78	10	K7806Z-9/16
5/8 in	13,94	5	K7806Z-5/8
11/16 in	13,94	5	K7806Z-11/16
3/4 in	13,98	5	K7806Z-3/4
13/16 in	13,98	5	K7806Z-13/16
7/8 in	13,98	5	K7806Z-7/8
15/16 in	14,43	5	K7806Z-15/16
1 in	15,77	5	K7806Z-1
1 1/16 in	16,84	5	K7806Z-1.1/16
1 1/8 in	19,06	5	K7806Z-1.1/8
1 1/4 in	29,48	5	K7806Z-1.1/4
1 5/16 in	34,24	5	K7806Z-1.5/16
1 3/8 in	34,24	5	K7806Z-1.3/8
1 7/16 in	34,24	5	K7806Z-1.7/16
1 1/2 in	39,35	5	K7806Z-1.1/2

Vaso de impacto 1/2" hexagonal en pulgadas, con acabado fosfatado



SBK7801Z

Ø	€		
3/8 in	11,00	1	SBK7801Z-3/8
7/16 in	11,00	1	SBK7801Z-7/16
1/2 in	11,00	1	SBK7801Z-1/2
9/16 in	11,36	1	SBK7801Z-9/16
5/8 in	11,36	1	SBK7801Z-5/8
11/16 in	11,36	1	SBK7801Z-11/16
3/4 in	11,36	1	SBK7801Z-3/4
13/16 in	11,52	1	SBK7801Z-13/16
7/8 in	11,52	1	SBK7801Z-7/8
15/16 in	13,40	1	SBK7801Z-15/16
1 in	13,93	1	SBK7801Z-1
1 1/16 in	15,02	1	SBK7801Z-1.1/16
1 1/8 in	15,92	1	SBK7801Z-1.1/8
1 1/4 in	26,17	1	SBK7801Z-1.1/4
1 5/16 in	30,28	1	SBK7801Z-1.5/16
1 3/8 in	30,28	1	SBK7801Z-1.3/8

Vaso de impacto largo 1/2" hexagonal en pulgadas, con acabado fosfatado



SBK7806Z

Ø	€		
3/8 in	14,40	10	SBK7806Z-3/8
7/16 in	14,40	10	SBK7806Z-7/16
1/2 in	14,40	10	SBK7806Z-1/2
9/16 in	14,40	10	SBK7806Z-9/16
5/8 in	14,55	5	SBK7806Z-5/8
11/16 in	14,55	1	SBK7806Z-11/16
3/4 in	14,60	1	SBK7806Z-3/4
13/16 in	14,60	1	SBK7806Z-13/16
7/8 in	14,60	1	SBK7806Z-7/8

Vaso impacto 1/2", reforzado



K7801VM

Ø	€		
17 mm	12,96	1	K7801VM-17
19 mm	12,96	1	K7801VM-19
22 mm	13,82	1	K7801VM-22
24 mm	14,17	1	K7801VM-24

BAHCO

Ø	€	SB	Icon
15/16 in	15,05	1	SBK7806Z-15/16
1 in	16,39	1	SBK7806Z-1
1 1/16 in	17,46	1	SBK7806Z-1.1/16
1 1/8 in	19,67	5	SBK7806Z-1.1/8
1 1/4 in	30,10	1	SBK7806Z-1.1/4
1 5/16 in	34,86	1	SBK7806Z-1.5/16
1 3/8 in	34,86	5	SBK7806Z-1.3/8
1 7/16 in	34,86	5	SBK7806Z-1.7/16
1 1/2 in	39,96	1	SBK7806Z-1.1/2

Vaso de impacto TORX® hembras 1/2"



K7801TORX-E

Icon	€	SB	Icon
E10	13,63	1	K7801TORX-E10
E12	13,63	1	K7801TORX-E12
E14	13,63	1	K7801TORX-E14
E16	13,63	1	K7801TORX-E16
E18	13,63	1	K7801TORX-E18
E20	14,77	1	K7801TORX-E20
E24	14,77	1	K7801TORX-E24

Articulación universal de impacto cardan 1/2"



K8167S

Icon	Icon	€	SB	Icon
1/2"	1/2"	34,64	1	K8167S

Vaso de impacto 1/2" con punta hexagonal



7993S

Icon	€	SB	Icon
5 mm	44,05	1	7993S0050
6 mm	40,23	1	7993S0060
8 mm	40,23	1	7993S0080
10 mm	42,69	1	7993S0100
12 mm	42,69	1	7993S0120
14 mm	44,05	1	7993S0140
17 mm	44,05	1	7993S0170
18 mm	44,05	1	7993S0180
19 mm	44,05	1	7993S0190

Adaptador portapuntas, macho, 1/2"



7807H-7809H

Icon	Icon	€	SB	Icon
1/2"	1/4 in	34,05	1	7807H
1/2"	5/16 in	34,05	1	7808H
1/2"	11.2 mm	32,27	1	7809H
1/2"	1/4 in	47,20	1	SB7807H
1/2"	5/16 in	47,20	1	SB7808H
1/2"	7/16 in	52,27	1	SB7809H

Amplificador de entrada 1/2" a salida 3/4"



K7764D/SBK7764D

Icon	Icon	€	SB	Icon
M 3/8"	F 1/2"	24,02	1	K7764D
M 3/8"	F 1/2"	22,93	1	SBK7764D

Vaso de impacto 1/2" con punta TORX®



7994S

Icon	€	SB	Icon
T20	21,12	1	7994S0200
T25	21,78	1	7994S0250
T27	22,45	1	7994S0270
T-30	23,07	1	7994S0300
T-40	23,07	1	7994S0400
T-45	23,07	1	7994S0450
T-50	23,07	1	7994S0500
T-55	24,40	1	7994S0550
T-60	26,99	1	7994S0600
T-70	27,00	1	7994S0700

SB: Embalaje en blister

SB: Embalaje en blister

Alargadera de impacto 1/2"



K8160D

Icon	€	SB	Icon
75 mm	14,10	1	K8160D-1
125 mm	17,36	1	K8160D-2
250 mm	27,51	1	K8160D-3
75 mm	14,85	1	SBK8160D-1
125 mm	18,10	1	SBK8160D-2
250 mm	28,26	1	SBK8160D-3

SB: Embalaje en blister

Adaptador de accionamiento de 1/2" a 3/4" con acabado fosfatado



K8964D/SBK8964D

Icon	Icon	€	SB	Icon
3/4"	1/2"	16,59	1	K8964D
M 3/4"	F 1/2"	11,76	1	SBK8964D

SB: Embalaje en blister con información del producto



Muelle de fijación



K560F-4/5

		€		
1/2"	10-14 mm	3,46	5	K560F-4
1/2"	15-32 mm	3,46	5	K560F-5

Juego de vasos de impacto extra cortos, 1/2"



K7800M-13

	€		
43 x 128 x 195 mm	81,34	1	K7800M/13

K7800M-10, K7800M-11, K7800M-12, K7800M-13, K7800M-14, K7800M-15, K7800M-16, K7800M-17, K7800M-18, K7800M-19, K7800M-21, K7800M-22, K7800M-24



4750IB-A5



Juego de vasos de impacto 1/2", serie larga



K7806M/S4

	€		
4	51,24	1	K7806M/S4

K7806M-19, K7806M-22, K7806M-17, K7806M-24



4750IB-A5



Juego de 4 vasos de impacto, 1/2"



K7801VM/S4

	€		
4	61,36	1	K7801VM/S4

K7801VM-22, K7801VM-19, K7801VM-17, K7801VM-24

Juego de vasos de impacto cuadrado de 1/2", pulgadas



K7801Z/10

		€		
10	60 x 220 x 280 mm	113,44	1	K7801Z/10

K7801Z-7/16, K7801Z-1/2, K7801Z-11/16, K7801Z-5/8, K7801Z-13/16, K7801Z-3/4, K7801Z-15/16, K7801Z-7/8, K7801Z-1, K7801Z-9/16

Juego de vasos de impacto serie larga cuadrado de 1/2", pulgadas



K7806Z/10

		€		
10	60 x 220 x 280 mm	141,37	1	K7806Z/10

K7806Z-7/16, K7806Z-1/2, K7806Z-9/16, K7806Z-3/4, K7806Z-13/16, K7806Z-11/16, K7806Z-1, K7806Z-7/8, K7806Z-15/16, K7806Z-5/8

Juego de 14 vasos de impacto 1/2", serie larga, mm



DD/S14

	€		
14	96,77	4	DD/S14

K7806M-10, K7806M-11, K7806M-12, K7806M-13, K7806M-14, K7806M-15, K7806M-16, K7806M-17, K7806M-18, K7806M-19, K7806M-21, K7806M-22, K7806M-24, K7806M-27

Juego de 20 vasos de impacto (10 standar y 10 largos), serie larga



D-DD/

	€		
20	94,75	4	D-DD/S20

K7801M-10, K7801M-11, K7801M-12, K7801M-13, K7801M-14, K7801M-15, K7801M-16, K7801M-17, K7801M-18, K7801M-19

K7806M-10, K7806M-11, K7806M-12, K7806M-13, K7806M-14, K7806M-16, K7806M-17, K7806M-18, K7806M-19

Juego de 10 vasos de impacto cuadrado 1/2"



D/

	€		
10	61,26	6	D/S10

K7801M-10, K7801M-11, K7801M-12, K7801M-13, K7801M-14, K7801M-15, K7801M-16, K7801M-17, K7801M-18, K7801M-19

Juego de 14 vasos de impacto 1/2"



D/S14

	€		
14	83,71	6	D/S14

K7801M-10, K7801M-11, K7801M-12, K7801M-13, K7801M-14, K7801M-15, K7801M-16, K7801M-17, K7801M-18, K7801M-19, K7801M-21, K7801M-22, K7801M-24, K7801M-27

Juego de 10 vasos de impacto, serie larga, mm



DD/

	€		
10	60,33	6	DD/S10

K7806M-10, K7806M-11, K7806M-12, K7806M-13, K7806M-14, K7806M-15, K7806M-16, K7806M-17, K7806M-18, K7806M-19

Vaso de impacto 3/4", hexagonal, mm



K8901M

Ø	€		
17 mm	23,17	1	K8901M-17
18 mm	23,15	1	K8901M-18
19 mm	23,17	1	K8901M-19
21 mm	23,26	1	K8901M-21
22 mm	23,26	1	K8901M-22
23 mm	23,26	1	K8901M-23
24 mm	24,15	1	K8901M-24
27 mm	25,49	1	K8901M-27
28 mm	26,66	1	K8901M-28
29 mm	29,88	1	K8901M-29
30 mm	32,66	1	K8901M-30
32 mm	32,56	1	K8901M-32
33 mm	33,39	1	K8901M-33
34 mm	33,36	1	K8901M-34
36 mm	35,18	1	K8901M-36
38 mm	36,73	1	K8901M-38
41 mm	43,67	1	K8901M-41
46 mm	44,35	1	K8901M-46
50 mm	72,67	1	K8901M-50
55 mm	87,58	1	K8901M-55
60 mm	102,80	1	K8901M-60

SB: Embalaje en blíster con información del producto

Vasos de impacto 3/4", mm



SBK8901M

Ø	€		
17 mm	17,61	1	SBK8901M-17
18 mm	17,61	1	SBK8901M-18
19 mm	17,33	1	SBK8901M-19
21 mm	17,33	1	SBK8901M-21
22 mm	17,33	1	SBK8901M-22
23 mm	17,61	1	SBK8901M-23
24 mm	17,33	1	SBK8901M-24
27 mm	17,33	1	SBK8901M-27
28 mm	17,71	1	SBK8901M-28
29 mm	17,98	1	SBK8901M-29
30 mm	18,35	1	SBK8901M-30
32 mm	19,00	1	SBK8901M-32
33 mm	19,98	1	SBK8901M-33
34 mm	20,17	1	SBK8901M-34
36 mm	21,19	1	SBK8901M-36
38 mm	21,97	1	SBK8901M-38
41 mm	24,62	1	SBK8901M-41
46 mm	28,42	1	SBK8901M-46
55 mm	39,73	1	SBK8901M-55
60 mm	44,96	1	SBK8901M-60
50 mm	33,09	1	SBK8901M-50

SB: Embalaje en blíster con información del producto

Vaso de impacto 3/4", serie larga, hexagonal, mm



K8906M

Ø	€		
17 mm	42,73	1	K8906M-17
19 mm	43,71	1	K8906M-19
21 mm	44,43	1	K8906M-21
22 mm	44,43	1	K8906M-22
24 mm	45,14	1	K8906M-24
27 mm	46,84	1	K8906M-27
30 mm	47,83	1	K8906M-30
32 mm	50,94	1	K8906M-32
33 mm	51,67	1	K8906M-33
34 mm	54,42	1	K8906M-34
36 mm	56,30	1	K8906M-36
41 mm	58,73	1	K8906M-41
42 mm	42,69	1	K8906M-42
46 mm	67,58	1	K8906M-46

SB: Embalaje en blíster con información del producto



Vasos de impacto 3/4", hexagonal, pulgadas



K8901Z

Ø	€		
11/16 in	27,79	1	K8901Z-11/16
3/4 in	27,79	1	K8901Z-3/4
13/16 in	27,79	1	K8901Z-13/16
7/8 in	27,79	1	K8901Z-7/8
15/16 in	27,79	1	K8901Z-15/16
1 in	29,07	1	K8901Z-1
1 1/16 in	29,07	1	K8901Z-1.1/16
1 1/8 in	29,07	1	K8901Z-1.1/8
1 3/16 in	29,07	1	K8901Z-1.3/16
1 1/4 in	29,77	1	K8901Z-1.1/4
1 5/16 in	29,77	1	K8901Z-1.5/16
1 3/8 in	30,56	1	K8901Z-1.3/8
1 7/16 in	30,56	1	K8901Z-1.7/16
1 1/2 in	39,18	1	K8901Z-1.1/2
1 9/16 in	36,74	1	K8901Z-1.9/16
1 5/8 in	43,20	1	K8901Z-1.5/8
1 11/16 in	46,90	1	K8901Z-1.11/16
1 3/4 in	51,41	1	K8901Z-1.3/4
1 13/16 in	46,35	1	K8901Z-1.13/16
1 7/8 in	59,51	1	K8901Z-1.7/8
1 15/16 in	65,79	1	K8901Z-1.15/16
2 in	65,79	1	K8901Z-2
2 1/16 in	74,57	1	K8901Z-2.1/16
2 3/16 in	82,60	1	K8901Z-2.3/16
2 1/4 in	86,61	1	K8901Z-2.1/4
2 3/8 in	93,07	1	K8901Z-2.3/8

SB: Embalaje en blíster con información del producto

Vasos de impacto 3/4" serie larga, pulgadas



K8906Z

Ø	€		
3/4 in	46,69	1	K8906Z-3/4
13/16 in	46,69	1	K8906Z-13/16
7/8 in	46,69	1	K8906Z-7/8
15/16 in	46,69	1	K8906Z-15/16
1 mm	46,69	1	K8906Z-1
1 1/16 in	46,69	1	K8906Z-1.1/16
1.1/8 in	46,69	1	K8906Z-1.1/8

Ø	€		
1.1/4 in	48,55	1	K8906Z-1.1/4
1.5/16 in	55,47	1	K8906Z-1.5/16
1.3/8 in	56,00	1	K8906Z-1.3/8
1.7/16 in	56,00	1	K8906Z-1.7/16
1.1/2 in	57,73	1	K8906Z-1.1/2
1.5/8 in	57,73	1	K8906Z-1.5/8
1.3/4 in	69,94	1	K8906Z-1.3/4
2 mm	105,65	1	K8906Z-2

SB: Embalaje en blíster con información del producto

Vaso de impacto 3/4" con punta hexagonal



7993T

Ø	€		
12 mm	53,60	1	7993T0120
14 mm	58,91	1	7993T0140
17 mm	58,91	1	7993T0170
19 mm	58,91	1	7993T0190
22 mm	70,48	1	7993T0220
24 mm	70,48	1	7993T0240

Adaptador portapuntas de impacto 3/4", hexágono de 22 mm



Articulación universal de impacto cardan 3/4"



K8967S

Ø	Ø	€	
3/4"	3/4"	92,02	1 K8967S

Reductor/Amplificador de impacto de entrada 3/4"



K8164F

Ø	Ø	€	
1/2"	3/4"	33,68	1 K8164F

Este producto no está garantizado contra la rotura del cuadrado macho

Adaptador de aumento de 3/4" a 1" con acabado fosfatado



K9564F

Ø	Ø	€	
1"	3/4"	37,34	1 K9564F

Extensión de impacto 3/4"



K8960F

Longitud	€	Paquete	Artículo
175 mm	45,94	1	K8960F-2
250 mm	55,15	1	K8960F-3
325 mm	59,76	1	K8960F-4

Muelle de fijación



K560F-6

Tamaño	Longitud	€	Paquete	Artículo
3/4"	17-46 mm	3,93	5	K560F-6

Juego de 8 llaves de vaso de impacto 3/4" mm



K8901M/8

Cantidad	Dimensiones	€	Paquete	Artículo
8	65 x 240 x 350 mm	238,09	1	K8901M/8

K8901M-27, K8901M-24, K8901M-21, K8901M-22, K8901M-30, K8901M-32, K8901M-36, K8901M-41

Juego de 8 vasos de impacto 3/4" serie larga, mm



K8906M/8

Cantidad	Dimensiones	€	Paquete	Artículo
8	80 x 250 x 315 mm	370,28	1	K8906M/8

K8906M-24, K8906M-27, K8906M-30, K8906M-41, K8906M-36, K8906M-21, K8906M-22, K8906M-32

Juego de 8 llaves de vaso de impacto de 3/4", pulgadas



K8901Z/8

Cantidad	Dimensiones	€	Paquete	Artículo
8	80 x 250 x 310 mm	247,09	1	K8901Z/8

K8901Z-1.1/16, K8901Z-1, K8901Z-1.3/8, K8901Z-1.5/16, K8901Z-1.1/4, K8901Z-1.1/2, K8901Z-1.7/16, K8901Z-1.1/8

Juego de vasos de impacto 3/4", pulgadas



K8901Z/18

Cantidad	Dimensiones	€	Paquete	Artículo
18	100 x 210 x 595 mm	516,55	1	K8901Z/18

K8901Z-11/16, K8901Z-3/4, K8901Z-13/16, K8901Z-7/8, K8901Z-15/16, K8901Z-1, K8901Z-1.1/16, K8901Z-1.1/8, K8901Z-1.3/16, K8901Z-1.1/4, K8901Z-1.5/16, K8901Z-1.3/8, K8901Z-1.7/16, K8901Z-1.1/2, K8901Z-1.9/16, K8901Z-1.5/8, K8901Z-1.11/16, K8901Z-1.3/4

Juego de 8 vasos de impacto 3/4" serie larga, pulgadas



K8906Z/8

Cantidad	Dimensiones	€	Paquete	Artículo
8	125 x 250 x 110 mm	413,80	1	K8906Z/8

K8906Z-1, K8906Z-1.1/16, K8906Z-1.1/8, K8906Z-1.1/4, K8906Z-1.5/16, K8906Z-1.3/8, K8906Z-1.7/16, K8906Z-1.1/2



Vaso de impacto 1", hexagonal, mm



K9501M

Ø	€		
22 mm	43,37	1	K9501M-22
24 mm	43,37	1	K9501M-24
27 mm	44,73	1	K9501M-27
30 mm	45,96	1	K9501M-30
32 mm	48,26	1	K9501M-32
33 mm	49,64	1	K9501M-33
34 mm	51,18	1	K9501M-34
36 mm	51,18	1	K9501M-36
38 mm	51,58	1	K9501M-38
41 mm	58,12	1	K9501M-41
42 mm	68,47	1	K9501M-42
46 mm	71,48	1	K9501M-46
50 mm	79,66	1	K9501M-50
55 mm	91,20	1	K9501M-55
60 mm	111,09	1	K9501M-60
65 mm	132,93	1	K9501M-65
70 mm	151,57	1	K9501M-70
75 mm	158,49	1	K9501M-75
80 mm	166,83	1	K9501M-80
85 mm	261,98	1	K9501M-85

Vasos de impacto 1", hexagonal, pulgadas



K9501Z

Ø	€		
1 in	43,82	1	K9501Z-1
1 1/16 in	43,82	1	K9501Z-1.1/16
1 1/8 in	43,82	1	K9501Z-1.1/8
1 3/16 in	43,82	1	K9501Z-1.3/16
1 1/4 in	43,82	1	K9501Z-1.1/4
1 5/16 in	48,74	1	K9501Z-1.5/16
1 3/8 in	54,56	1	K9501Z-1.3/8
1 7/16 in	54,56	1	K9501Z-1.7/16
1 1/2 in	55,91	1	K9501Z-1.1/2
1 9/16 in	55,91	1	K9501Z-1.9/16
1 5/8 in	59,82	1	K9501Z-1.5/8
1 11/16 in	68,79	1	K9501Z-1.11/16
1 3/4 in	68,79	1	K9501Z-1.3/4
1 13/16 in	74,85	1	K9501Z-1.13/16
1 7/8 in	74,85	1	K9501Z-1.7/8
15/16 in	77,53	1	K9501Z-1.15/16
2 in	87,70	1	K9501Z-2
2 1/8 in	98,54	1	K9501Z-2.1/8
2 3/16 in	98,54	1	K9501Z-2.3/16
2 1/4 in	107,05	1	K9501Z-2.1/4
2 5/16 in	107,05	1	K9501Z-2.5/16
2 9/16 in	147,64	1	K9501Z-2.9/16
2 3/4 in	155,07	1	K9501Z-2.3/4

Adaptador portapuntas de impacto, hexagono de 22 mm



K9509H5

Ø	Ø	€	
22 mm	1"	97,16	1 K9509H5

Vaso de impacto 1", serie larga, hexagonal, mm



K9506M

Ø	€		
22 mm	72,10	1	K9506M-22
24 mm	72,10	1	K9506M-24
27 mm	72,10	1	K9506M-27
30 mm	72,81	1	K9506M-30
32 mm	74,83	1	K9506M-32
33 mm	75,85	1	K9506M-33
34 mm	77,86	1	K9506M-34
36 mm	77,86	1	K9506M-36
38 mm	79,33	1	K9506M-38
41 mm	87,57	1	K9506M-41
46 mm	95,25	1	K9506M-46
50 mm	115,77	1	K9506M-50
55 mm	140,96	1	K9506M-55
60 mm	172,26	1	K9506M-60

Vasos de impacto 1", serie larga, pulgadas



K9506Z

Ø	€		
1 in	64,50	1	K9506Z-1
1 1/16 in	65,52	1	K9506Z-1.1/16
1 3/16 in	65,52	1	K9506Z-1.3/16
1 1/4 in	65,73	1	K9506Z-1.1/4
1 7/16 in	65,73	1	K9506Z-1.7/16
1 1/2 in	67,93	1	K9506Z-1.1/2
1 5/8 in	73,42	1	K9506Z-1.5/8
1 13/16 in	94,12	1	K9506Z-1.13/16
1 7/8 in	106,15	1	K9506Z-1.7/8

Reductor/Amplificador de impacto de entrada 1"



K8964G

Ø	Ø	€	
3/4"	1"	35,75	1 K8964G

Este producto no está garantizado contra la rotura del cuadrado macho

Adaptador de accionamiento cuadrado de 1" a 1-1/2" con acabado fosfatado



K9895G

1 1/2"	1"	€		
		175,52	1	K9895G

Extensión de impacto 1"



K9560G

	€		
100 mm	55,47	1	K9560G-0
125 mm	60,57	1	K9560G-1
175 mm	66,26	1	K9560G-2
325 mm	77,33	1	K9560G-3
300 mm	66,49	1	K9560G-4
400 mm	81,26	1	K9560G-5

Articulación universal de impacto cardan 1"



K9567S

1"	1"	€		
		193,31	1	K9567S

Punta de atornillador mm



K8909ML/K9509ML

	€		
12 mm	18,29	1	K8909ML-12
14 mm	18,29	1	K8909ML-14
17 mm	18,29	1	K8909ML-17
19 mm	18,77	1	K9509ML-19
22 mm	24,61	1	K9509ML-22
24 mm	24,68	1	K9509ML-24

Muelle de fijación



K560F-7/8

1"	19-70 mm	€		
		4,44	5	K560F-7
1 & 1 1/2"	75-80 & 46-90 mm	5,82	5	K560F-8

Vasos de impacto 1.1/2"



K9801M

	€		
46 mm	202,35	1	K9801M-46
50 mm	202,35	1	K9801M-50
55 mm	214,30	1	K9801M-55
60 mm	237,97	1	K9801M-60

	€		
65 mm	258,86	1	K9801M-65
70 mm	279,56	1	K9801M-70
75 mm	303,32	1	K9801M-75
80 mm	332,98	1	K9801M-80
85 mm	382,60	1	K9801M-85
90 mm	424,22	1	K9801M-90
95 mm	501,30	1	K9801M-95
100 mm	538,35	1	K9801M-100
105 mm	582,87	1	K9801M-105
110 mm	736,18	1	K9801M-110
115 mm	776,42	1	K9801M-115
120 mm	835,88	1	K9801M-120
125 mm	862,83	1	K9801M-125
130 mm	958,70	1	K9801M-130
135 mm	1.054,56	1	K9801M-135
140 mm	1.102,50	1	K9801M-140
145 mm	1.214,35	1	K9801M-145
150 mm	1.438,07	1	K9801M-150
155 mm	1.629,79	1	K9801M-155

Vasos de impacto profundos 1.1/2", mm



K9806M

	€		
41 mm	413,41	1	K9806M-41
46 mm	413,41	1	K9806M-46
50 mm	413,41	1	K9806M-50
55 mm	413,41	1	K9806M-55
60 mm	423,37	1	K9806M-60
65 mm	469,53	1	K9806M-65
70 mm	527,92	1	K9806M-70
75 mm	590,42	1	K9806M-75
80 mm	714,10	1	K9806M-80
85 mm	718,54	1	K9806M-85
90 mm	758,76	1	K9806M-90
95 mm	893,22	1	K9806M-95
100 mm	973,39	1	K9806M-100
105 mm	1.069,91	1	K9806M-105
110 mm	1.366,00	1	K9806M-110
115 mm	1.521,45	1	K9806M-115
120 mm	2.921,82	1	K9806M-120



Vasos de impacto 1.1/2", pulgadas



K9801Z

	€		
1 3/8 in	128,77	1	K9801Z-1.3/8
1 7/16 in	128,37	1	K9801Z-1.7/16
1 1/2 in	128,37	1	K9801Z-1.1/2
1 9/16 in	132,47	1	K9801Z-1.9/16
1 5/8 in	131,16	1	K9801Z-1.5/8
1 11/16 in	131,16	1	K9801Z-1.11/16
1 3/4 in	138,13	1	K9801Z-1.3/4
1 13/16 in	138,13	1	K9801Z-1.13/16
1 7/8 in	138,13	1	K9801Z-1.7/8
1 15/16 in	138,13	1	K9801Z-1.15/16
2 in	138,13	1	K9801Z-2
2 1/16 in	139,48	1	K9801Z-2.1/16
2 1/8 in	141,17	1	K9801Z-2.1/8
2 3/16 in	143,52	1	K9801Z-2.3/16
2 1/4 in	159,38	1	K9801Z-2.1/4
2 5/16 in	172,48	1	K9801Z-2.5/16
2 3/8 in	189,35	1	K9801Z-2.3/8
2 7/16 in	191,23	1	K9801Z-2.7/16
2 1/2 in	190,50	1	K9801Z-2.1/2
2 9/16 in	199,22	1	K9801Z-2.9/16
2 5/8 in	206,31	1	K9801Z-2.5/8
2 11/16 in	220,06	1	K9801Z-2.11/16
2 3/4 in	240,84	1	K9801Z-2.3/4
2 13/16 in	207,44	1	K9801Z-2.13/16
2 7/8 in	262,74	1	K9801Z-2.7/8
2 15/16 in	280,05	1	K9801Z-2.15/16
3 in	294,34	1	K9801Z-3
3 1/16 in	320,74	1	K9801Z-3.1/16
3 1/8 in	336,92	1	K9801Z-3.1/8
3 1/4 in	333,84	1	K9801Z-3.1/4
3 5/16 in	343,27	1	K9801Z-3.5/16
3 3/8 in	356,48	1	K9801Z-3.3/8
3 7/16 in	367,93	1	K9801Z-3.7/16
3 1/2 in	371,58	1	K9801Z-3.1/2
3 9/16 in	416,92	1	K9801Z-3.9/16
3 5/8 in	487,78	1	K9801Z-3.5/8
3 11/16 in	571,16	1	K9801Z-3.11/16
3 3/4 in	558,46	1	K9801Z-3.3/4
3 13/16 in	555,51	1	K9801Z-3.13/16
3 7/8 in	655,38	1	K9801Z-3.7/8
3 15/16 in	656,12	1	K9801Z-3.15/16
4 in	664,99	1	K9801Z-4
4 1/16 in	672,76	1	K9801Z-4.1/16
4 1/8 in	698,42	1	K9801Z-4.1/8
4 1/4 in	714,11	1	K9801Z-4.1/4
4 5/16 in	760,26	1	K9801Z-4.5/16
4 3/8 in	805,87	1	K9801Z-4.3/8
4 7/16 in	824,49	1	K9801Z-4.7/16
4 1/2 in	843,93	1	K9801Z-4.1/2
4 5/8 in	863,30	1	K9801Z-4.5/8
4 3/4 in	1.034,29	1	K9801Z-4.3/4

Vasos de impacto profundos 1.1/2", pulgadas



K9806Z

	€		
1 3/8 in	192,23	1	K9806Z-1.3/8
1 7/16 in	193,68	1	K9806Z-1.7/16
1 1/2 in	191,80	1	K9806Z-1.1/2
1 5/8 in	193,68	1	K9806Z-1.5/8
1 11/16 in	193,68	1	K9806Z-1.11/16
2 in	203,04	1	K9806Z-2
2 1/16 in	203,04	1	K9806Z-2.1/16
2 3/16 in	219,94	1	K9806Z-2.3/16
2 1/4 in	228,69	1	K9806Z-2.1/4
2 5/16 in	233,61	1	K9806Z-2.5/16
2 3/8 in	280,84	1	K9806Z-2.3/8
2 7/16 in	281,96	1	K9806Z-2.7/16
2 1/2 in	285,95	1	K9806Z-2.1/2
2 9/16 in	287,56	1	K9806Z-2.9/16
2 5/8 in	347,52	1	K9806Z-2.5/8
2 11/16 in	353,53	1	K9806Z-2.11/16
2 3/4 in	369,05	1	K9806Z-2.3/4
2 13/16 in	385,78	1	K9806Z-2.13/16
2 7/8 in	407,54	1	K9806Z-2.7/8
2 15/16 in	412,67	1	K9806Z-2.15/16
3 in	443,87	1	K9806Z-3
3 1/16 in	466,96	1	K9806Z-3.1/16
3 1/8 in	490,65	1	K9806Z-3.1/8
3 3/16 in	499,06	1	K9806Z-3.3/16
3 1/4 in	526,10	1	K9806Z-3.1/4
3 5/16 in	526,14	1	K9806Z-3.5/16
3 3/8 in	546,32	1	K9806Z-3.3/8
3 7/16 in	569,51	1	K9806Z-3.7/16
3 1/2 in	569,51	1	K9806Z-3.1/2
3 9/16 in	607,91	1	K9806Z-3.9/16
3 5/8 in	598,68	1	K9806Z-3.5/8
3 11/16 in	759,13	1	K9806Z-3.11/16
3 3/4 in	780,76	1	K9806Z-3.3/4
3 13/16 in	759,13	1	K9806Z-3.13/16
3 7/8 in	841,26	1	K9806Z-3.7/8
3 15/16 in	819,72	1	K9806Z-3.15/16
4 in	828,55	1	K9806Z-4
4 1/16 in	808,33	1	K9806Z-4.1/16
4 1/8 in	1.014,18	1	K9806Z-4.1/8
4 1/4 in	1.047,80	1	K9806Z-4.1/4
4 5/16 in	1.165,07	1	K9806Z-4.5/16
4 3/8 in	1.256,31	1	K9806Z-4.3/8
4 1/2 in	1.300,33	1	K9806Z-4.1/2
4 5/8 in	1.332,66	1	K9806Z-4.5/8
4 3/4 in	1.422,03	1	K9806Z-4.3/4

Articulación universal de impacto cardan 1.1/2"



K9867S

	€		
1 1/2	654,43	1	K9867S

Alargadera de impacto 1.1/2"



K9860H

	€		
255 mm	416,85	1	K9860H-1
380 mm	459,82	1	K9860H-2
510 mm	463,86	1	K9860H-3

Adaptador de impacto



K9598H

	€		
1	274,25	1	K9598H

Adaptador de accionamiento cuadrado de 1,1/2" a 2,1/2" con acabado fosfatado



K9998H

		€		
2 1/2	1 1/2	932,29	1	K9998H

Adaptador reductor de accionamiento cuadrado de 2,1/2" a 1,1/2" con acabado fosfatado



K9899H

		€		
1 1/2	2 1/2	1.222,34	1	K9899H

Muelle de fijación



K560F-9

		€		
1 1/2"	95-120 mm	6,88	5	K560F-9





BAHCO



Destornilladores



DESTORNILLADORES ERGO™ CON MANGO TRI-COMPONENTE

Juego 5 destornilladores ERGO™



ergo



BE-9885



€



5 40,50 1 BE-9885

BE-8910, BE-8930, BE-8915, BE-8920, BE-8925



Juego 6 destornilladores ERGO™



ergo



BE-9881



€



6 42,41 1 BE-9881

BE-8020, BE-8040



BE-8150, BE-8155



BE-8620, BE-8610



Juego 6 destornilladores ERGO™



ergo



BE-9882



€



6 44,13 1 BE-9882

BE-8020, BE-8040



BE-8155, BE-8150



BE-8810, BE-8820



Juego 6 destornilladores ERGO™



ergo



BE-9884



€



6 45,99 1 BE-9884

BE-8611, BE-8621



BE-8040, BE-8241



BE-8811, BE-8821



Juego 6 destornilladores ERGO™



ergo



BE-9886



€

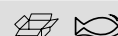

6 44,94 1 BE-9886

BE-8030



BE-8150



BE-8621, BE-8611



BE-8821, BE-8811



Juego 6 destornilladores ERGO™



ergo®



BE-9871

	€		
6	45,01	1	BE-9871

BE-8220S		
BE-8920, BE-8925		
BE-8820		
BE-8611, BE-8620		

Juego de destornilladores ranurados/Phillips/Pozidriv/TORX® ERGO™ con mango de goma (8 piezas)



ergo®



BE-9872

			€		
8	45 x 170 x 340 mm	595 g	74,76	1	BE-9872

BE-8925, BE-8920, BE-8915		
BE-8030		
BE-8821, BE-8811		
BE-8621, BE-8611		

Juego 13 destornilladores ERGO™



ergo®



BE-9875

	€		
13	100,25	1	BE-9875

BE-8040		
BE-8150, BE-8155		
BE-8621		
BE-8811, BE-8821		
BE-8910, BE-8915, BE-8920, BE-8925		
BE-8010S, BE-8230S		
BE-8811S		

Juego 13 destornilladores Ergo™



ergo®



BE-9879

	€		
13	80,98	1	BE-9879

BE-8010, BE-8040		
BE-8150		
BE-8611, BE-8621		
BE-8811, BE-8821		
BE-8910, BE-8915, BE-8920, BE-8925		
BE-8220SL		
BE-8620SL		



Juego 15 destornilladores ERGO™



BE-9877

	€		
15	108,65	1	BE-9877

BE-8030		
BE-8150		
BE-8611, BE-8621		
BE-8811, BE-8821		
BE-8910, BE-8915, BE-8920, BE-8925		
BE-8220S, BE-8040S, BE-8050S		
BE-8611S, BE-8621S		

Destornillador ERGO™ plano



BE-8002 - BE-8252

			€		
2.0 mm	60 mm	17 mm	3,91	5	BE-8002
2.5 mm	60 mm	17 mm	4,04	5	BE-8010
2.5 mm	75 mm	17 mm	4,34	5	BE-8210
3.0 mm	60 mm	17 mm	5,74	5	BE-8020
3.0 mm	75 mm	17 mm	4,47	5	BE-8020L
3.0 mm	100 mm	17 mm	4,81	5	BE-8022
3.0 mm	125 mm	17 mm	6,52	5	BE-8220
3.0 mm	200 mm	17 mm	7,70	5	BE-8225
3.5 mm	75 mm	17 mm	4,94	5	BE-8030
3.5 mm	125 mm	17 mm	6,21	5	BE-8230
3.5 mm	200 mm	17 mm	7,93	5	BE-8235
4.0 mm	100 mm	20 mm	5,65	5	BE-8040
4.0 mm	175 mm	20 mm	9,28	5	BE-8240
5.5 mm	125 mm	27 mm	7,86	5	BE-8241
5.5 mm	150 mm	27 mm	8,79	5	BE-8242
5.5 mm	200 mm	27 mm	11,88	5	BE-8250L
6.0 mm	150 mm	36 mm	9,60	5	BE-8251
6.5 mm	150 mm	36 mm	10,37	5	BE-8252

Destornillador ERGO™ plano para tornillos ranurados



BE-8150 - BE-8258

			€		
5.5 mm	100 mm	27 mm	7,74	5	BE-8150
5.5 mm	150 mm	27 mm	10,63	5	BE-8250
6.5 mm	125 mm	36 mm	9,71	5	BE-8155
6.5 mm	150 mm	36 mm	11,03	5	BE-8255
8 mm	150 mm	36 mm	12,12	5	BE-8256
8 mm	175 mm	36 mm	12,45	5	BE-8257
10 mm	200 mm	36 mm	16,36	5	BE-8258

Destornillador ERGO™ plano



BE-8158 - BE-8890





			€		
5.5 mm	125 mm	27 mm	12,54	5	BE-8158
6.5 mm	150 mm	36 mm	14,75	5	BE-8159
8 mm	125 mm	36 mm	14,39	5	BE-8160
8 mm	175 mm	36 mm	16,72	5	BE-8260
8 mm	175 mm	36 mm	17,09	5	BE-8865
10 mm	175 mm	36 mm	18,40	5	BE-8870
12 mm	200 mm	36 mm	23,49	5	BE-8880
14 mm	200 mm	36 mm	29,70	5	BE-8890

Destornillador ERGO™ plano stubby



BE-8330 - BE-8360

			€		
3.5 mm	25 mm	36 mm	5,29	5	BE-8330
4.0 mm	25 mm	36 mm	5,65	5	BE-8340
5.0 mm	25 mm	36 mm	7,25	5	BE-8350
5.0 mm	45 mm	36 mm	7,83	5	BE-8450

			€		
6.5 mm	25 mm	36 mm	7,58	5	BE-8355
6.0 mm	45 mm	36 mm	9,07	5	BE-8455
8.0 mm	25 mm	36 mm	8,70	5	BE-8360

Destornillador ERGO™ phillips







ergo®



BE-8600 - BE-8624



			€		
PH 0	60 mm	17 mm	5,97	5	BE-8600
PH 0	100 mm	17 mm	6,13	5	BE-8605
PH 0	200 mm	17 mm	8,60	5	BE-8608
PH 1	75 mm	27 mm	7,33	5	BE-8610
PH 1	75 mm	20 mm	7,24	5	BE-8611
PH 1	* 200 mm	27 mm	10,97	5	BE-8610L
PH 2	100 mm	36 mm	8,19	5	BE-8620
PH 2	100 mm	27 mm	8,04	5	BE-8621
PH 2	150 mm	36 mm	9,14	5	BE-8622
PH 2	* 200 mm	36 mm	13,80	5	BE-8620L
PH 3	150 mm	36 mm	14,03	5	BE-8623
PH 4	200 mm	36 mm	19,43	5	BE-8624

Destornillador ERGO™ phillips





ergo®



BE-8628 - BE-8640



			€		
PH 1	100 mm	27 mm	9,73	5	BE-8628
PH 2	125 mm	36 mm	12,35	5	BE-8629
PH 3	150 mm	36 mm	16,91	5	BE-8630
PH 4	200 mm	36 mm	22,52	5	BE-8640

Destornillador ERGO™ Phillips Stubby



ergo®



BE-8601/BE-8602



			€		
PH 1	25 mm	36 mm	7,84	5	BE-8601
PH 2	25 mm	36 mm	7,84	5	BE-8602

Destornillador ERGO™ Torx







ergo®



BE-8800 - BE-8824



			€		
PZ 0	60 mm	17 mm	7,12	5	BE-8800
PZ 1	75 mm	27 mm	7,96	5	BE-8810
PZ 1	75 mm	20 mm	7,24	5	BE-8811
PZ 1	200 mm	27 mm	9,26	5	BE-8810L
PZ 2	100 mm	36 mm	9,71	5	BE-8820
PZ 2	100 mm	27 mm	16,37	5	BE-8821
PZ 2	200 mm	36 mm	19,76	5	BE-8820L
PZ 3	150 mm	36 mm	14,77	5	BE-8823
PZ 4	200 mm	36 mm	20,60	5	BE-8824

Destornillador ERGO™ Pozidriv







ergo®



BE-8828 - BE-8840



			€		
PZ 1	100 mm	27 mm	11,93	5	BE-8828
PZ 2	125 mm	36 mm	15,34	5	BE-8829
PZ 3	150 mm	36 mm	14,81	5	BE-8830
PZ 4	200 mm	36 mm	19,38	5	BE-8840



Destornillador ERGO™ Pozidriv Stubby



BE-8801/BE-8802



			€		
PZ 1	25 mm	36 mm	8,03	5	BE-8801
PZ 2	25 mm	36 mm	8,03	5	BE-8802

Destornillador ERGO™ Torx



BE-8904 - BE-8945



			€		
T 4	75 mm	17 mm	7,51	5	BE-8904
T 5	75 mm	17 mm	7,51	5	BE-8905
T 6	75 mm	17 mm	7,58	5	BE-8906
T 7	75 mm	17 mm	7,63	5	BE-8907
T 8	75 mm	17 mm	7,66	5	BE-8908
T 9	75 mm	17 mm	7,69	5	BE-8909
T 10	75 mm	20 mm	7,70	5	BE-8910
T 15	100 mm	27 mm	7,86	5	BE-8915
T 20	100 mm	27 mm	7,96	5	BE-8920
T 25	125 mm	27 mm	8,49	5	BE-8925
T 27	125 mm	27 mm	8,71	5	BE-8927
T30	150 mm	36 mm	10,41	5	BE-8930
T40	150 mm	36 mm	12,55	5	BE-8940
T45	150 mm	36 mm	13,49	5	BE-8945

Destornillador ERGO™ Torx



BE-7907 - BE-7940



			€		
TR 7	75 mm	17 mm	10,55	5	BE-7907
TR 8	75 mm	17 mm	10,59	5	BE-7908
TR 9	75 mm	17 mm	10,62	5	BE-7909

BAHCO

			€		
TR 10	75 mm	20 mm	10,66	5	BE-7910
TR 15	100 mm	27 mm	10,73	5	BE-7915
TR 20	100 mm	27 mm	10,79	5	BE-7920
TR 25	125 mm	27 mm	11,23	5	BE-7925
TR 27	125 mm	27 mm	11,40	5	BE-7927
TR 30	150 mm	36 mm	12,98	5	BE-7930
TR 40	150 mm	36 mm	15,17	5	BE-7940

Destornillador ERGO™ TORX® bola



BE-7515 - BE-7540



			€		
T 15	100 mm	27 mm	8,24	5	BE-7515
T 20	100 mm	27 mm	8,43	5	BE-7520
T 25	125 mm	27 mm	8,91	5	BE-7525
T 27	125 mm	27 mm	9,68	5	BE-7527
T 30	150 mm	36 mm	10,39	5	BE-7530
T 40	150 mm	36 mm	11,53	5	BE-7540

Destornillador ERGO™ Torx



BE-7715 - BE-7740



			€		
T 15	100 mm	27 mm	10,30	5	BE-7715
T 20	100 mm	27 mm	10,37	5	BE-7720
T 25	125 mm	27 mm	10,70	5	BE-7725
T 27	125 mm	27 mm	10,83	5	BE-7727
T 30	150 mm	36 mm	11,23	5	BE-7730
T 40	150 mm	36 mm	11,49	5	BE-7740

Destornillador ERGO™ Torx



ergo



BE-6902 - BE-6903



Bit	Length	Tip	€	Box	Part
2 mm	75 mm	17 mm	4,18	5	BE-6902
2.5 mm	75 mm	17 mm	4,25	5	BE-6925
3 mm	75 mm	20 mm	4,72	5	BE-6903

Destornillador ERGO™ hexagonal con bola



ergo



BE-8715 - BE-8710



Bit	Length	Tip	€	Box	Part
1.5 mm	60 mm	17 mm	4,93	5	BE-8715
2 mm	100 mm	17 mm	5,11	5	BE-8702
2.5 mm	100 mm	17 mm	5,22	5	BE-8725
3 mm	100 mm	20 mm	5,29	5	BE-8703
4 mm	100 mm	27 mm	6,02	5	BE-8704
5 mm	100 mm	36 mm	7,47	5	BE-8705
6 mm	125 mm	36 mm	8,58	5	BE-8706
8 mm	150 mm	36 mm	12,28	5	BE-8708
10 mm	150 mm	36 mm	13,86	5	BE-8710

Destornillador ERGO™ hexagonal con bola, pulgadas



ergo



BE-8700-7/64 - BE-8700-5/16



Bit	Length	Tip	€	Box	Part
7/64 in	100 mm	20 mm	8,87	5	BE-8700-7/64
5/32 in	100 mm	27 mm	6,23	5	BE-8700-5/32
3/16 in	100 mm	27 mm	7,98	5	BE-8700-3/16
7/32 in	100 mm	36 mm	8,58	5	BE-8700-7/32
1/4 in	125 mm	36 mm	10,06	5	BE-8700-1/4
5/16 in	150 mm	36 mm	14,20	5	BE-8700-5/16
3/8 in	150 mm	36 mm	18,16	5	BE-8700-3/8

Destornillador ERGO™ Robertson



ergo



BE-9001 - BE-9003



Bit	Length	Tip	€	Box	Part
# 1	80 mm	27 mm	8,82	5	BE-9001
# 2	80 mm	27 mm	9,48	5	BE-9002
# 3	100 mm	27 mm	9,87	5	BE-9003

Destornillador ERGO™ para tornillos TRI-WING®



ergo



BE-9100 - BE-9105



Bit	Length	Tip	€	Box	Part
0	80 mm	20 mm	9,35	5	BE-9100
1	80 mm	20 mm	9,35	5	BE-9101
2	80 mm	27 mm	9,35	5	BE-9102
3	80 mm	27 mm	9,35	5	BE-9103
4	100 mm	27 mm	10,73	5	BE-9104
5	100 mm	27 mm	10,73	5	BE-9105

Destornillador ERGO™ TORQ-SET®



ergo



BE-8080



Bit	Length	Tip	€	Box	Part
1	75 mm	27 mm	15,20	5	BE-8080-1
2	75 mm	27 mm	15,66	5	BE-8080-2
3	75 mm	27 mm	15,66	5	BE-8080-3
4	75 mm	27 mm	15,66	5	BE-8080-4
5	75 mm	27 mm	15,66	5	BE-8080-5
6	75 mm	27 mm	15,66	5	BE-8080-6
8	100 mm	27 mm	21,63	5	BE-8080-8
10	100 mm	27 mm	21,63	5	BE-8080-10



Mango ERGO™, puntero



ergo®



BE-8985

			€		
6 mm	100 mm	27 mm	8,43	5	BE-8985

Punzón ERGO™



ergo®



BE-8986

			€		
4 mm	36 mm	50 mm	8,77	5	BE-8986

Mango ERGO™, puntero



ergo®



BE-8980

			€		
6 mm	100 mm	27 mm	8,87	5	BE-8980

Destornillador stecker ERGO™



ergo®



BE-6400M

			€		
4 mm	75 mm	20 mm	12,21	5	BE-6400M-4
5 mm	75 mm	20 mm	12,89	5	BE-6400M-5
5.5 mm	75 mm	20 mm	12,89	5	BE-6400M-5.5
7 mm	75 mm	20 mm	14,15	5	BE-6400M-7

Destornillador stecker ERGO™, con boca larga



ergo®



BE-78

			€		
3 mm	125 mm	20 mm	12,21	5	BE-7803
3.5 mm	125 mm	20 mm	12,21	5	BE-7835
4 mm	125 mm	20 mm	12,21	5	BE-7804
4.5 mm	125 mm	20 mm	12,21	5	BE-7845
5 mm	125 mm	20 mm	12,89	5	BE-7805
5.5 mm	125 mm	20 mm	12,89	5	BE-7855
6 mm	125 mm	20 mm	13,49	5	BE-7806
7 mm	125 mm	27 mm	14,15	5	BE-7807
8 mm	125 mm	27 mm	17,03	5	BE-7808
9 mm	125 mm	36 mm	17,36	5	BE-7809
10 mm	125 mm	36 mm	17,86	5	BE-7810
11 mm	125 mm	36 mm	18,37	5	BE-7811
12 mm	125 mm	36 mm	20,73	5	BE-7812
13 mm	125 mm	36 mm	21,41	5	BE-7813
14 mm	125 mm	36 mm	23,27	5	BE-7814

Destornillador stecker ERGO™, varilla flexible



ergo®



BE-76

Ø	Longitud	Longitud de punta	€	Paquete	Artículo
6 mm	150 mm	27 mm	20,02	5	BE-7606
7 mm	150 mm	27 mm	20,30	5	BE-7607
8 mm	150 mm	27 mm	21,67	5	BE-7608

Portapuntas ERGO™ hexágono hembra 1/4"



ergo®



BE-8577

Ø	Longitud	Longitud de punta	€	Paquete	Artículo
1/4 in	118 mm	36 mm	15,34	5	BE-8577

Mango destornillador multivarilla hexágono 1/4"



ergo®



BE-8575

Ø	Longitud	€	Paquete	Artículo
1/4 in	122 mm	19,92	1	BE-8575

Pack 2 varillas hex 1/4" para tornillos planos, 100 mm



8020-2P - 8252-2P

Ø	Longitud de punta	€	Paquete	Artículo
3.0 mm	0.5 mm	8,78	1	8020-2P
3.5 mm	0.6 mm	8,78	1	8030-2P
4.0 mm	0.8 mm	8,78	1	8040-2P
5.5 mm	1.0 mm	8,87	1	8242-2P
6.5 mm	1.2 mm	8,87	1	8252-2P

Pack 2 varillas hex 1/4" para tornillos Philips, 100 mm



8600-2P - 8630-2P

Ø	Longitud de punta	€	Paquete	Artículo
0		8,72	1	8600-2P
1		8,72	1	8610-2P
2		8,78	1	8620-2P
3		8,78	1	8630-2P

Pack 2 varillas hex 1/4" para tornillos Pozidriv, 100 mm



8800-2P - 8830-2P

Ø	Longitud de punta	€	Paquete	Artículo
0		8,72	1	8800-2P
1		8,72	1	8810-2P
2		8,78	1	8820-2P
3		8,78	1	8830-2P



Pack 2 varillas hex para tornillos TORX®, 100mm



8910-2P - 8940-2P

	€		
10	8,72	1	8910-2P
15	8,72	1	8915-2P
20	8,78	1	8920-2P
25	8,78	1	8925-2P
27	8,78	1	8927-2P
30	8,87	1	8930-2P
40	8,87	1	8940-2P

Pack 2 varillas hex 1/4" para tornillos Philips, 300mm



8610L-2P - 8620L-2P

	€		
1	12,34	1	8610L-2P
2	12,34	1	8620L-2P

Pack de 2 varillas 1/4" hexagonales con punta hexagonal, 100mm



8703-2P - 8706-2P

	€		
3 mm	8,99	1	8703-2P
4 mm	8,99	1	8704-2P
5 mm	8,99	1	8705-2P
6 mm	8,99	1	8706-2P

Pack 2 varillas hex 1/4" para tornillos Pozidriv, 300mm



8810L-2P - 8820L-2P

	€		
1	12,34	1	8810L-2P
2	12,34	1	8820L-2P

Varilla hexagonal 1/4" para tornillos TORX®, 300mm



Pack 2 varillas hex 1/4" para tornillos ranurados, 300mm



8040L-2P - 8252L-2P

		€		
0.8 mm	4.0 mm	12,53	1	8040L-2P
1.0 mm	5.5 mm	12,53	1	8242L-2P
1.2 mm	6.5 mm	12,53	1	8252L-2P

8915L-2P - 8930L-2P

	€		
T15	13,35	1	8915L-2P
T20	13,35	1	8920L-2P
T25	13,35	1	8925L-2P
T27	13,35	1	8927L-2P
T30	13,35	1	8930L-2P

Varilla hexagonal 1/4" para tornillos de cabeza Phillips, 400mm



8620XL-1P - 8252XL-1P



	€		
2	11,22	1	8620XL-1P
3	11,22	1	8630XL-1P

Varilla hexagonal 1/4" para tornillos de cabeza Pozidriv, 400mm



8820XL-1P - 8830XL-1P



	€		
2	11,22	1	8820XL-1P
3	11,22	1	8830XL-1P

Varilla hexagonal 1/4" para tornillos de cabeza plana, 400mm



8252XL-1P - 8256XL-1P



	€		
1.2 mm	11,22	1	8252XL-1P
6.5 mm			

Juego destornillador con 6 varillas intercambiables ERGO™



BE-8571

		€		
7	85 x 85 x 210 mm	63,59	1	BE-8571

BE-8575		
8242-2P, 8252-2P		
8610-2P, 8620-2P		
8810-2P, 8820-2P		

Juego destornillador con 8 varillas intercambiables ERGO™



BE-8572

		€		
9	85 x 80 x 210 mm	67,44	1	BE-8572

BE-8575		
8242-2P, 8252-2P		
8610-2P, 8620-2P		
8810-2P, 8820-2P		
8910-2P, 8915-2P		



Juego destornillador con 7 varillas intercambiables TORX® ERGO™



ergo®



BE-8573



		€		
8	85 x 85 x 210 mm	65,53	1	BE-8573

BE-8575		
8910-2P, 8915-2P, 8920-2P, 8925-2P, 8927-2P, 8930-2P, 8940-2P		

Juego destornilladores ERGO™ con varillas intercambiables, 7 piezas



ergo®



BE-8574



		€		
8	85 x 85 x 210 mm	66,09	1	BE-8574

BE-8575		
8610-2P, 8620-2P		
8040-2P		
8820-2P		
8920-2P, 8925-2P, 8930-2P		

Foam con 22 piezas con mango intercambiable, 16 varillas y 6 puntas ERGO™



ergo®



BE-8576

	€		
23	130,47	1	BE-8576

BE-8575		
8030-2P, 8040-2P, 8242-2P, 8252-2P		
8810-2P, 8820-2P, 8830-2P		
8610-2P, 8620-2P, 8630-2P		
8910-2P, 8915-2P, 8925-2P, 8930-2P, 8940-2P		
59S/H2, 59S/H3, 59S/H5, 59S/H4, 59S/H6		
59S/H8		

DESTORNILLADORES ERGO™ CON MANGO DE IMPACTO

Juego de 6 destornilladores de varilla pasante ERGO™



ergo®



BE-9881TB

	€		
6	56,70	1	BE-9881TB

BE-8135TB, BE-8145TB, BE-8150TB, BE-8155TB		
BE-8610TB, BE-8620TB		

Juego de 6 destornilladores de varilla pasante ERGO™



ergo®



BE-9882TB



€



6 59,39 1 BE-9882TB

BE-8135TB, BE-8145TB, BE-8150TB, BE-8155TB



BE-8810TB, BE-8820TB



Juego de 5 destornilladores ERGO™ varilla pasante



ergo®



BE-9885TB



€



5 52,23 1 BE-9885TB

BE-8915TB, BE-8920TB, BE-8925TB, BE-8930TB, BE-8940TB



Destornillador de varilla pasante ERGO™



ergo®



BE-8135TB - BE-8262TB



€



3.5 mm	75 mm	27 mm	8,52	10	BE-8135TB
4.5 mm	100 mm	27 mm	11,22	10	BE-8145TB
5.5 mm	100 mm	27 mm	12,98	10	BE-8150TB
6.5 mm	125 mm	36 mm	15,25	5	BE-8155TB

Ø	L	l	€	SB	Icon
8 mm	150 mm	36 mm	20,19	10	BE-8256TB
10 mm	175 mm	36 mm	24,34	10	BE-8258TB
12 mm	200 mm	36 mm	29,23	10	BE-8262TB
3.5 mm	75 mm	27 mm	9,15	1	SBE-8135TB
4.5 mm	100 mm	27 mm	11,83	1	SBE-8145TB
5.5 mm	100 mm	27 mm	13,59	1	SBE-8150TB
6.5 mm	125 mm	36 mm	15,88	1	SBE-8155TB

SB: Presentación en clip

Destornillador ERGO™ varilla hexagonal, pasante



ergo®



BE-8610TB - BE-8624TB

Icon	L	l	€	SB	Icon
PH 1	100 mm	27 mm	13,83	10	BE-8610TB
PH 2	125 mm	36 mm	15,35	10	BE-8620TB
PH 3	150 mm	36 mm	20,46	10	BE-8623TB
PH 4	175 mm	36 mm	29,78	10	BE-8624TB
PH 1	100 mm	27 mm	14,45	1	SBE-8610TB
PH 2	125 mm	36 mm	15,97	1	SBE-8620TB

SB: Presentación en clip

Destornillador ERGO™ varilla hexagonal, pasante



ergo®



BE-8810TB - BE-8824TB

Icon	L	l	€	SB	Icon
PZ 1	100 mm	27 mm	12,40	10	BE-8810TB
PZ 2	125 mm	36 mm	17,56	10	BE-8820TB
PZ 3	150 mm	36 mm	22,99	10	BE-8823TB
PZ 4	175 mm	36 mm	32,05	10	BE-8824TB
PZ 1	100 mm	27 mm	13,02	1	SBE-8810TB
PZ 2	125 mm	36 mm	18,17	1	SBE-8820TB



Destornillador ERGO™ varilla hexagonal, pasante



BE-8910TB - BE-8940TB

				€		
T 10		75 mm	27 mm	8,03	5	BE-8910TB
T 15		100 mm	27 mm	10,89	5	BE-8915TB
T 20		100 mm	27 mm	11,08	5	BE-8920TB
T 25		100 mm	27 mm	11,78	5	BE-8925TB
T 27		125 mm	27 mm	12,88	5	BE-8927TB
T 30		150 mm	36 mm	13,53	5	BE-8930TB
T 40		150 mm	36 mm	15,28	5	BE-8940TB
T 15		100 mm	27 mm	11,50	1	SBE-8915TB
T 20		100 mm	27 mm	11,69	1	SBE-8920TB
T 25		100 mm	27 mm	12,39	1	SBE-8925TB
T 30		150 mm	36 mm	14,14	1	SBE-8930TB
T 40		150 mm	36 mm	15,89	1	SBE-8940TB

SB: Presentación en clip

DESTORNILLADORES BAHCOFIT CON MANGO BI-MATERIAL

Juego 2 destornilladores BahcoFit



B219.002

		€		
2		10,05	1	B219.002



B191.040.100

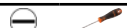

B192.001.100



Juego 2 destornilladores BahcoFit



B219.012

		€		
2		12,67	1	B219.012



BAHCO

B190.055.125



B192.002.125



Juego 4 destornilladores BahcoFit PL/PH



B219.004

		€		
4		23,31	1	B219.004



B191.030.100, B191.055.125



B192.001.100, B192.002.125



Juego de destornilladores Phillips BahcoFit con mango de goma - 4 piezas



B219.014

		€		
4		20,60	1	B219.014



B192.000.075, B192.001.100, B192.002.125, B192.003.150



Juego 5 destornilladores BahcoFit PL/RECTA/PH



B219.005



€



5

27,20

1 B219.005

B191.030.075, B191.040.100



B190.055.125



B192.001.100, B192.002.125



Juego 5 destornilladores BahcoFit PL/RECTA/PZ



B219.015



€



5

26,70

1 B219.015

B191.030.075, B191.040.100



B190.055.125



B193.001.100, B193.002.125



Juego 5 destornilladores BahcoFit TORX



B219.025



€



5

30,40

1 B219.025

B194.010.075, B194.015.100, B194.020.100, B194.025.125,
B194.030.150



Juego 5 destornilladores BahcoFit TORX INVOLABLE



B219.035



€

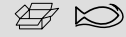

5

37,69

1 B219.035

B141.010.075, B141.015.100, B141.020.100, B141.025.125,
B141.030.150



Juego de destornilladores BahcoFit con mango de goma - 5 piezas



B219.045



€



5

23,69

1 B219.045

B191.030.100, B191.040.125



B190.055.125, B190.065.150, B190.080.175

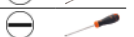

Juego 6 destornilladores BahcoFit PL/RECTA/PH



B219.006



€



6 31,85 1 B219.006

B191.030.075, B191.040.100



B190.055.125, B190.065.125

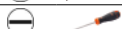

B192.001.100, B192.002.125



Juego 6 destornilladores BahcoFit PL/RECTA/PZ



B219.016



€



6 32,53 1 B219.016

B191.030.075, B191.040.100

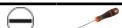

B190.055.125, B190.065.125



B193.001.100, B193.002.125



Juego 6 destornilladores BahcoFit RECTA/PH/PZ



B219.026



€



6 33,73 1 B219.026

BAHCO

B191.030.075, B191.040.100



B192.001.100, B192.002.125

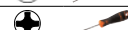

B193.001.100, B193.002.125

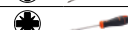

Juego 7 destornilladores BahcoFit POZI/TORX



B219.007



€



7 42,59 1 B219.007

B193.001.100, B193.002.125



B194.010.075, B194.015.100, B194.020.100, B194.025.125,
B194.030.150



Juego 7 destornilladores BahcoFit PLANA/RECTA/PH



B219.017



€



7 40,67 1 B219.017

B191.035.100, B191.040.100



B190.055.125, B190.065.150, B190.080.150



B192.001.100, B192.002.125



Juego 7 destornilladores Bahcofit



B219.027



€



7 44,03 1 B219.027

B194.010.075, B194.015.100, B194.020.100, B194.025.125,
B194.027.125, B194.030.150, B194.040.150



Juego 8 destornilladores BahcoFit PL/RECTA/PH/EXTRACORTO PH,PZ



B219.008



€



8 51,62 1 B219.008

B191.040.100, B191.055.125



B190.065.150, B190.080.175



B192.001.100, B192.002.125



B195.060.025



B195.002.025



Juego de 10 destornilladores BahcoFit



B219.110



€



10 61,55 1 B219.110

B190.055.100



B192.002.125



B193.002.125



B194.010.075, B194.015.100, B194.020.100



B196.025.075, B196.040.100



B142.001.080



806-1-1



Juego de 10 destornilladores BahcoFit ranurados/Phillips/Pozidriv/Robertson



B219.210



€



10 4,5 x 33 x 17 mm 60,24 1 B219.210

B194.006.075, B194.008.075, B194.009.075, B194.010.075,
B194.015.100, B194.020.100, B194.025.125, B194.027.125,
B194.030.150, B194.040.150



Juego 10 destornilladores BahcoFit RECTA/PL/PH/PZ/ROBERTSON



B219.010

	€		
10	54,22	1	B219.010

B191.030.075	
B190.055.100, B190.065.125, B190.080.150	
B192.001.100, B192.002.125, B192.003.150	
B195.902.025	
B144.001.100, B144.002.125	

Destornillador Boca Plana BahcoFit



B190

			€		
4 mm	75 mm	24.5 mm	4,72	10	B190.040.075
4 mm	100 mm	24.5 mm	4,77	10	B190.040.100
5.5 mm	100 mm	30 mm	6,04	10	B190.055.100
5.5 mm	125 mm	30 mm	6,16	10	B190.055.125
6.5 mm	125 mm	34 mm	7,57	10	B190.065.125
6.5 mm	150 mm	34 mm	8,62	10	B190.065.150
8 mm	150 mm	34 mm	9,47	10	B190.080.150
8 mm	175 mm	34 mm	9,73	10	B190.080.175
10 mm	200 mm	34 mm	12,77	10	B190.100.200
12 mm	250 mm	34 mm	16,58	10	B190.120.250
14 mm	250 mm	34 mm	17,66	10	B190.140.250
4 mm	75 mm	24.5 mm	5,45	1	SB190.040.075
4 mm	100 mm	24.5 mm	5,51	1	SB190.040.100
5.5 mm	100 mm	30 mm	6,78	1	SB190.055.100
5.5 mm	125 mm	30 mm	6,91	1	SB190.055.125
6.5 mm	125 mm	34 mm	8,34	1	SB190.065.125
6.5 mm	150 mm	34 mm	9,37	1	SB190.065.150
8 mm	150 mm	34 mm	10,21	1	SB190.080.150
8 mm	175 mm	34 mm	10,47	1	SB190.080.175
10 mm	200 mm	34 mm	13,53	1	SB190.100.200
12 mm	250 mm	34 mm	17,34	1	SB190.120.250
14 mm	250 mm	34 mm	18,42	1	SB190.140.250

SB: Presentación en clip

Destornillador Boca Recta BahcoFit



B191

			€		
2.5 mm	75 mm	24.5 mm	3,40	10	B191.025.075
3 mm	75 mm	24.5 mm	3,50	10	B191.030.075
3 mm	100 mm	24.5 mm	3,75	10	B191.030.100
3 mm	200 mm	24.5 mm	6,02	10	B191.030.200
3.5 mm	100 mm	24.5 mm	3,86	10	B191.035.100
4 mm	100 mm	24.5 mm	4,42	10	B191.040.100
4 mm	125 mm	24.5 mm	4,85	10	B191.040.125
4 mm	250 mm	24.5 mm	7,25	10	B191.040.250
5.5 mm	125 mm	30 mm	6,14	10	B191.055.125
5.5 mm	150 mm	30 mm	6,87	10	B191.055.150
5.5 mm	300 mm	30 mm	9,27	10	B191.055.300
6.5 mm	150 mm	34 mm	8,10	10	B191.065.150
6.5 mm	300 mm	34 mm	10,63	10	B191.065.300
2.5 mm	75 mm	24.5 mm	4,13	1	SB191.025.075
3 mm	75 mm	24.5 mm	4,24	1	SB191.030.075
3 mm	100 mm	24.5 mm	4,50	1	SB191.030.100
3 mm	200 mm	24.5 mm	6,76	1	SB191.030.200
3.5 mm	100 mm	24.5 mm	4,63	1	SB191.035.100
4 mm	100 mm	24.5 mm	5,15	1	SB191.040.100
4 mm	125 mm	24.5 mm	5,60	1	SB191.040.125
4 mm	250 mm	24.5 mm	7,98	1	SB191.040.250
5.5 mm	125 mm	30 mm	6,90	1	SB191.055.125
5.5 mm	150 mm	30 mm	7,62	1	SB191.055.150
5.5 mm	300 mm	30 mm	10,02	1	SB191.055.300
6.5 mm	150 mm	34 mm	8,84	1	SB191.065.150
6.5 mm	300 mm	34 mm	11,38	1	SB191.065.300

SB: Presentación en clip

Destornillador BahcoFit boca plana carrocer



B195

			€		
4 mm	25 mm	33 mm	4,42	10	B195.040.025
5.0 mm	25 mm	33 mm	5,68	10	B195.050.025
6 mm	25 mm	33 mm	5,93	10	B195.060.025
4 mm	25 mm	33 mm	5,15	1	SB195.040.025
5 mm	25 mm	33 mm	6,41	1	SB195.050.025
6 mm	25 mm	33 mm	6,67	1	SB195.060.025

SB: Presentación en clip

Destornillador Boca Phillips BahcoFit



B192



			€		
PH0	75 mm	24.5 mm	4,66	10	B192.000.075
PH0	200 mm	24.5 mm	6,71	10	B192.000.200
PH1	100 mm	30 mm	5,72	10	B192.001.100
PH1	250 mm	30 mm	8,56	10	B192.001.250
PH2	125 mm	34 mm	7,12	10	B192.002.125
PH2	150 mm	34 mm	7,51	10	B192.002.150
PH2	300 mm	34 mm	10,78	10	B192.002.300
PH3	150 mm	34 mm	10,96	10	B192.003.150
PH4	200 mm	34 mm	15,17	10	B192.004.200
PH0	75 mm	24.5 mm	5,41	1	SB192.000.075
PH0	200 mm	24.5 mm	7,47	1	SB192.000.200
PH1	100 mm	30 mm	6,47	1	SB192.001.100
PH1	250 mm	30 mm	9,31	1	SB192.001.250
PH2	125 mm	34 mm	7,87	1	SB192.002.125
PH2	300 mm	34 mm	11,52	1	SB192.002.300
PH3	150 mm	34 mm	11,70	1	SB192.003.150
PH4	200 mm	34 mm	15,92	1	SB192.004.200

SB: Presentación en clip

Destornillador PH Mango Carrocero



B195PH



			€		
PH1	25 mm	33 mm	5,93	10	B195.001.025
PH2	25 mm	33 mm	5,93	10	B195.002.025
PH1	25 mm	33 mm	6,67	1	SB195.001.025
PH2	25 mm	33 mm	6,67	1	SB195.002.025

SB: Presentación en clip

Destornillador Boca Pozidriv BahcoFit



B193



			€		
PZ0	75 mm	24.5 mm	5,54	10	B193.000.075
PZ1	100 mm	30 mm	6,21	10	B193.001.100
PZ2	125 mm	34 mm	7,57	10	B193.002.125
PZ3	150 mm	34 mm	11,54	10	B193.003.150
PZ4	200 mm	34 mm	16,08	10	B193.004.200
PZ0	75 mm	24.5 mm	6,30	1	SB193.000.075
PZ1	100 mm	30 mm	6,97	1	SB193.001.100
PZ2	125 mm	34 mm	8,34	1	SB193.002.125
PZ3	150 mm	34 mm	12,30	1	SB193.003.150
PZ4	200 mm	34 mm	16,83	1	SB193.004.200

SB: Presentación en clip

Destornillador BahcoFit PZ, carrocerero



B195PZ



			€		
PZ1	25 mm	33 mm	6,26	10	B195.901.025
PZ2	25 mm	33 mm	6,67	10	B195.902.025
PZ1	25 mm	33 mm	7,01	1	SB195.901.025
PZ2	25 mm	33 mm	7,43	1	SB195.902.025

SB: Presentación en clip



Destornillador Boca Torx BahcoFit



B194

				€		
T4		75 mm	24.5 mm	6,58	10	B194.004.075
T5		75 mm	24.5 mm	6,38	10	B194.005.075
T6		75 mm	24.5 mm	5,93	10	B194.006.075
T7		75 mm	24.5 mm	5,97	10	B194.007.075
T8		75 mm	24.5 mm	5,99	10	B194.008.075
T9		75 mm	24.5 mm	6,01	10	B194.009.075
T10		75 mm	24.5 mm	6,02	10	B194.010.075
T15		100 mm	24.5 mm	6,14	10	B194.015.100
T20		100 mm	24.5 mm	6,21	10	B194.020.100
T25		125 mm	30 mm	6,62	10	B194.025.125
T27		125 mm	30 mm	6,79	10	B194.027.125
T30		150 mm	34 mm	8,13	10	B194.030.150
T40		150 mm	34 mm	9,80	10	B194.040.150
T45		150 mm	34 mm	10,52	5	B194.045.150
T4		75 mm	24.5 mm	7,34	1	SB194.004.075
T5		75 mm	24.5 mm	7,16	1	SB194.005.075
T6		75 mm	24.5 mm	6,67	1	SB194.006.075
T7		75 mm	24.5 mm	6,70	1	SB194.007.075
T8		75 mm	24.5 mm	6,72	1	SB194.008.075
T9		75 mm	24.5 mm	6,75	1	SB194.009.075
T10		75 mm	24.5 mm	6,76	1	SB194.010.075
T15		100 mm	24.5 mm	6,90	1	SB194.015.100
T20		100 mm	24.5 mm	6,97	1	SB194.020.100
T25		125 mm	30 mm	7,38	1	SB194.025.125
T27		125 mm	30 mm	7,55	1	SB194.027.125
T30		150 mm	34 mm	8,88	1	SB194.030.150
T40		150 mm	34 mm	10,55	1	SB194.040.150
T45		150 mm	34 mm	11,27	1	SB194.045.150

SB: Presentación en clip

Destornillador Torx Inviolable BahcoFit



B141

				€		
TR7		75 mm	24.5 mm	8,24	5	B141.007.075
TR8		75 mm	24.5 mm	8,27	5	B141.008.075
TR9		75 mm	24.5 mm	8,31	5	B141.009.075
TR10		75 mm	24.5 mm	8,33	5	B141.010.075
TR15		100 mm	24.5 mm	8,40	5	B141.015.100
TR20		100 mm	24.5 mm	8,43	5	B141.020.100
TR25		125 mm	30 mm	8,77	5	B141.025.125
TR27		125 mm	30 mm	8,89	5	B141.027.125
TR30		150 mm	34 mm	10,14	5	B141.030.150
TR40		150 mm	34 mm	11,84	5	B141.040.150
TR7		75 mm	24.5 mm	8,99	1	SB141.007.075
TR8		75 mm	24.5 mm	9,02	1	SB141.008.075
TR9		75 mm	24.5 mm	9,04	1	SB141.009.075

BAHCO

				€		
TR10		75 mm	24.5 mm	9,07	1	SB141.010.075
TR15		100 mm	24.5 mm	9,13	1	SB141.015.100
TR20		100 mm	24.5 mm	9,17	1	SB141.020.100
TR25		125 mm	30 mm	9,53	1	SB141.025.125
TR27		125 mm	30 mm	9,66	1	SB141.027.125
TR30		150 mm	34 mm	10,90	1	SB141.030.150
TR40		150 mm	34 mm	12,60	1	SB141.040.150

SB: Presentación en clip

Destornillador Hexagonal Bola BahcoFit



B143

				€		
2		100 mm	24.5 mm	3,97	5	B143.020.100
2.5		100 mm	24.5 mm	4,07	10	B143.025.100
3		100 mm	24.5 mm	4,13	10	B143.030.100
4		100 mm	24.5 mm	4,80	10	B143.040.100
5		100 mm	30 mm	5,84	10	B143.050.100
6		125 mm	34 mm	6,70	10	B143.060.125
8		150 mm	34 mm	9,60	5	B143.080.150
2		100 mm	24.5 mm	4,75	1	SB143.020.100
2.5		100 mm	24.5 mm	4,83	1	SB143.025.100
3		100 mm	24.5 mm	4,88	1	SB143.030.100
4		100 mm	24.5 mm	5,44	1	SB143.040.100
5		100 mm	30 mm	6,58	1	SB143.050.100
6		125 mm	34 mm	7,46	1	SB143.060.125
8		150 mm	34 mm	10,34	1	SB143.080.150

SB: Presentación en clip

Destornillador BahcoFit boca Robertson



B144

				€		
#1		100 mm	24.5 mm	6,90	5	B144.001.100
#2		125 mm	30 mm	7,39	5	B144.002.125
#3		150 mm	34 mm	7,71	5	B144.003.150
#1		100 mm	24.5 mm	7,64	1	SB144.001.100
#2		125 mm	30 mm	8,15	1	SB144.002.125
#3		150 mm	34 mm	8,46	1	SB144.003.150

SB: Presentación en clip

Destornillador Puntero boca redonda BahcoFit



B145

Ø	Longitud	Longitud punta	€	Paquete	Artículo
6 mm	100 mm	30 mm	6,58	5	B145.006.100
6 mm	100 mm	30 mm	7,34	1	SB145.006.100

SB: Presentación en clip

Destornillador BahcoFit Puntero boca cuadrada



B146

Ø	Longitud	Longitud punta	€	Paquete	Artículo
6 mm	100 mm	30 mm	6,92	5	B146.006.100
6 mm	100 mm	30 mm	7,66	1	SB146.006.100

SB: Presentación en clip

Punzón carrocer



B195Awl

Ø	Longitud	Longitud punta	€	Paquete	Artículo
4 mm	50 mm	33 mm	5,93	5	B195.006.050
4 mm	50 mm	33 mm	6,67	1	SB195.006.050

SB: Presentación en clip

Destornillador Stecker BahcoFit



B198

Ø	Longitud	Longitud punta	€	Paquete	Artículo
4 mm	125 mm	24.5 mm	9,56	5	B198.040.125
4.5 mm	125 mm	24.5 mm	9,56	5	B198.045.125
5 mm	150 mm	30 mm	10,06	5	B198.050.150
5.5 mm	150 mm	30 mm	10,06	5	B198.055.150
6 mm	150 mm	30 mm	10,52	5	B198.060.150
6 mm	150 mm	34 mm	15,34	5	B198.060.150F
7 mm	150 mm	34 mm	11,05	5	B198.070.150
7 mm	150 mm	34 mm	15,86	5	B198.070.150F
8 mm	150 mm	34 mm	13,30	5	B198.080.150
8 mm	150 mm	34 mm	16,94	5	B198.080.150F
9 mm	150 mm	34 mm	13,56	5	B198.090.150
10 mm	150 mm	34 mm	13,95	5	B198.100.150
11 mm	150 mm	34 mm	14,34	5	B198.110.150
12 mm	150 mm	34 mm	16,19	5	B198.120.150
13 mm	150 mm	34 mm	16,57	5	B198.130.150
14 mm	150 mm	34 mm	18,16	5	B198.140.150
4 mm	125 mm	24.5 mm	10,28	1	SB198.040.125
4.5 mm	125 mm	24.5 mm	10,28	1	SB198.045.125
5 mm	150 mm	30 mm	10,83	1	SB198.050.150
5.5 mm	150 mm	30 mm	10,83	1	SB198.055.150
6 mm	150 mm	30 mm	11,27	1	SB198.060.150
6 mm	150 mm	34 mm	16,10	1	SB198.060.150F
7 mm	150 mm	34 mm	11,80	1	SB198.070.150
7 mm	150 mm	34 mm	16,59	1	SB198.070.150F
8 mm	150 mm	34 mm	14,04	1	SB198.080.150
8 mm	150 mm	34 mm	17,66	1	SB198.080.150F
9 mm	150 mm	34 mm	14,31	1	SB198.090.150
10 mm	150 mm	34 mm	14,71	1	SB198.100.150
11 mm	150 mm	34 mm	15,10	1	SB198.110.150
12 mm	150 mm	34 mm	16,96	1	SB198.120.150
13 mm	150 mm	34 mm	17,46	1	SB198.130.150
14 mm	150 mm	34 mm	18,91	1	SB198.140.150

SB: Presentación en clip



DESTORNILLADORES CON MANGO DE GOMA

Juego 3 destornilladores serie-600



600-3



€



3

12,84

1 600-3

613-3-100



611-5.5-125



615-1-100



Juego 4 destornilladores Serie 600



602-4-LA



€



4

18,10

1 602-4-LA

613-3-100



611-5.5-100

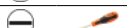

615-1-100, 615-2-125



Juego 5 destornilladores serie-600



604-5



€



5

24,05

1 604-5

613-3-100



611-4-100, 611-6.5-125



615-1-100, 615-2-125



Juego 5 destornilladores Serie 600



612-5



€



5

28,87

1 612-5

618-10-75, 618-15-100, 618-20-100, 618-25-125, 618-30-150



Juego 6 destornilladores Serie 600



605-6



	€		
6	29,23	1	605-6

613-3-75, 613-4-100		
615-1-100, 615-2-125		
616-1-100, 616-2-125		

Juego 6 destornilladores Serie-600



606-6



	€		
6	28,28	1	606-6

611-5.5-100, 611-6.5-125		
613-3-75, 613-4-100		
615-1-100, 615-2-125		

Juego 6 destornilladores Serie-600



610-6



	€		
6	29,09	1	610-6

611-5.5-100, 611-6.5-125		
613-3-75, 613-4-100		
616-1-100, 616-2-125		

Juego 10 destornilladores Serie 600



605-10-PC-AU



	€		
10	56,12	1	605-10-PC-AU

Incluye carroceros PZ2x25 y Robertson R1x100, R2x100

611-5.5-100, 611-6.5-125, 611-8-150		
613-3-75		
615-1-100, 615-2-125, 615-3-150		
616-2-25, 619-1-100, 619-2-100		



Destornillador plano



611

Ø	Longitud	Longitud punta	€	Paquetes	Paquetes
3.5 mm	75 mm	25 mm	3,11	10	611-3.5-75
3.5 mm	100 mm	25 mm	3,26	10	611-3.5-100
4.0 mm	75 mm	25 mm	3,72	10	611-4-75
4.0 mm	100 mm	25 mm	4,15	10	611-4-100
5.5 mm	100 mm	30 mm	4,95	10	611-5.5-100
5.5 mm	125 mm	30 mm	5,22	10	611-5.5-125
6.5 mm	25 mm	35 mm	6,29	10	611-6.5-25
6.5 mm	125 mm	35 mm	6,31	10	611-6.5-125
6.5 mm	150 mm	35 mm	6,61	10	611-6.5-150
8.0 mm	150 mm	35 mm	8,02	10	611-8-150
8.0 mm	175 mm	35 mm	8,49	10	611-8-175
10.0 mm	200 mm	35 mm	10,25	10	611-10-200

Destornillador punta recta



613

Ø	Longitud	Longitud punta	€	Paquetes	Paquetes
3.0 mm	75 mm	25 mm	3,10	10	613-3-75
3.0 mm	100 mm	25 mm	3,16	10	613-3-100
3.5 mm	100 mm	25 mm	3,27	10	613-3.5-100
4.0 mm	100 mm	25 mm	3,67	10	613-4-100
4.0 mm	125 mm	25 mm	4,05	10	613-4-125
5.5 mm	150 mm	30 mm	5,42	10	613-5.5-150
6.5 mm	150 mm	35 mm	6,86	10	613-6.5-150

Destornillador Phillips



615

Tip	Longitud	Longitud punta	€	Paquetes	Paquetes
PH 0	75 mm	25 mm	3,40	10	615-0-75
PH 1	100 mm	30 mm	4,97	10	615-1-100
PH 2	25 mm	35 mm	6,29	10	615-2-25

BAHCO

Tip	Longitud	Longitud punta	€	Paquetes	Paquetes
PH 2	125 mm	35 mm	6,41	10	615-2-125
PH 3	150 mm	35 mm	9,74	10	615-3-150

Destornillador Pozidriv



616

Tip	Longitud	Longitud punta	€	Paquetes	Paquetes
PZ 0	75 mm	25 mm	4,42	10	616-0-75
PZ 1	100 mm	30 mm	5,35	10	616-1-100
PZ 2	125 mm	35 mm	6,88	10	616-2-125
PZ 3	150 mm	35 mm	10,32	10	616-3-150

Destornillador TORX®



618

Tip	Longitud	Longitud punta	€	Paquetes	Paquetes
T 10	75 mm	25 mm	5,15	10	618-10-75
T 15	100 mm	25 mm	5,42	10	618-15-100
T 20	100 mm	25 mm	5,42	10	618-20-100
T 25	125 mm	30 mm	6,29	10	618-25-125
T 27	125 mm	30 mm	6,29	10	618-27-125
T 30	150 mm	35 mm	7,74	10	618-30-150
T 40	150 mm	35 mm	8,79	10	618-40-150

DESTORNILLADORES CON MANGO DE CARRACA

Destornillador de carraca



808050

			€		
1/4"	125 mm	41.6 mm	41,83	50	808050

Juego puntas 1/4" y porta puntas de carraca, 36 piezas



59/S36BCR

		€		
36	43 x 135 x 215 mm	54,53	6	59/S36BCR

Destornillador de carraca con lámpara LED



808050L

			€		
1/4 in	10x35 mm	808050L	40,34	25	808050L
		808050L	10,25	1	808050L-SP1

Destornillador de carraca con mango en forma de pistola



808050P

			€		
1/4 in	135 mm	40 mm	40,34	50	808050P

Juego destornillador con carraca de mango giratorio, 25 piezas



808050P-

	€		
70 x 158 x 285 mm	127,62	10	808050P-25

Destornillador a carraca con mango en T extra corto



808050TS

			€		
1/4 in	68 mm	91 mm	21,43	1	808050TS



Destornillador a carraca extra corto



808050S

			€		
1/4 in	68 mm	41 mm	21,43	25	808050S

Juegos de destornillador a carraca extra corto de 18 piezas



808050S-18

	€		
46 x 130 x 195 mm	37,78	30	808050S-18

Juegos de destornillador a carraca extra corto de 22 piezas



808050S-22

	€		
46 x 130 x 195 mm	37,78	30	808050S-22

DESTORNILLADORES CON MANGO DE PRECISIÓN

Juego de destornilladores de precisión, 6 piezas



706-1

	€		
6	45,66	1	706-1

700-2-50, 700-2.5-50, 700-1.5-50, 700-3-50

701-0-50, 701-1-75

Juego de destornilladores de precisión, 6 piezas



706-2

	€		
6	47,60	1	706-2

700-1.5-50, 700-1.2-50, 700-1-50, 700-1.8-50

701-00-50, 701-0-50

Juego de destornilladores de precisión, 6 piezas



706-3



6

€

47,60

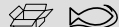

1 706-3

700-2.5-50, 700-2-50, 700-1.8-50, 700-1.5-50, 700-1.2-50, 700-1-50

Juego de destornilladores de precisión, 7 piezas



706-4



7

€

53,63



1 706-4

700-2.5-50, 700-3.5-75, 700-1.5-50

701-1-75, 701-0-50

703-8-50, 703-6-50

Juego de destornilladores de precisión, 24 piezas



706-5



24

€

181,59



1 706-5

700-3-50, 700-2-50, 700-3.5-75, 700-4-75, 700-1.5-50, 700-1.2-50, 700-1-50, 700-1.8-50

701-00-50, 701-0-50, 701-1-75

702-1-75, 702-0-50

703-6-50, 703-9-50, 703-10-50, 703-7-50, 703-8-50, 703-15-75, 703-20-75

704-2.5-50, 704-3-75, 704-1.5-50, 704-2-50

Destornilladores de precisión, ranurados



700



1 mm



50 mm



14 mm

€

7,67



5 700-1-50

1.2 mm

50 mm

14 mm

7,67

5 700-1.2-50

1.5 mm

50 mm

14 mm

7,67

5 700-1.5-50

1.8 mm

50 mm

14 mm

7,67

5 700-1.8-50

2 mm

50 mm

14 mm

6,71

5 700-2-50

2.5 mm

50 mm

14 mm

6,71

5 700-2.5-50

3 mm

50 mm

14 mm

6,42

5 700-3-50

3 mm

100 mm

14 mm

6,42

5 700-3-100

3 mm

200 mm

14 mm

7,38

5 700-3-200

3.5 mm

75 mm

14 mm

6,71

5 700-3.5-75

4 mm

75 mm

14 mm

6,95

5 700-4-75

4 mm

250 mm

14 mm

8,66

5 700-4-250



Destornilladores de precisión, Phillips



701



			€		
PH 00	50 mm	14 mm	7,96	5	701-00-50
PH 0	50 mm	14 mm	6,71	5	701-0-50
PH 0	200 mm	14 mm	8,44	5	701-0-200
PH 1	75 mm	14 mm	7,51	5	701-1-75
PH 1	250 mm	14 mm	7,97	5	701-1-250

Destornilladores de precisión, hexagonal esférica



704

			€		
1.5	50 mm	14 mm	8,44	5	704-1.5-50
2	50 mm	14 mm	8,44	5	704-2-50
2.5	50 mm	14 mm	8,44	5	704-2.5-50
3	75 mm	14 mm	8,44	5	704-3-75
3/32	75 mm	14 mm	8,43	5	704Z-3/32

Destornilladores de precisión, Pozidriv



702



			€		
PZ 0	50 mm	14 mm	7,56	5	702-0-50
PZ 1	75 mm	14 mm	8,04	5	702-1-75

Destornillador precisión, 4 bocas intercambiables



510034

			€		
0.25x1.5; 0.3x2; 0.4x2.5; 0.5x3	8.5 mm		17,37	10	510034

0,25x1,5x25; 0,3x2x25; 0,4x2,5x25; 0,5x3x25

Destornilladores de precisión, TORX®



703



			€		
T 4	50 mm	14 mm	9,18	5	703-4-50
T 5	50 mm	14 mm	9,18	5	703-5-50
T 6	50 mm	14 mm	7,35	5	703-6-50
T 7	50 mm	14 mm	7,35	5	703-7-50
T 8	50 mm	14 mm	7,35	5	703-8-50
T 9	50 mm	14 mm	7,35	5	703-9-50
T 10	50 mm	14 mm	7,35	5	703-10-50
T 15	75 mm	14 mm	7,35	5	703-15-75
T 20	75 mm	14 mm	7,35	5	703-20-75

Destornillador para tornillos ranurados



2784

			€		
2.5 mm	6 mm	100 mm	35,78	1	2784-2.5
3.5 mm	6 mm	104 mm	35,78	1	2784-3.5
4.5 mm	10 mm	110 mm	35,78	1	2784-4.5

Juego de destornilladores ranurados de precisión, 0,6-2,5 mm (5 piezas)



98505

	€		
5	33,26	5	98505

Juego de destornilladores ranurados de precisión, 1,0-3,5 mm (6 piezas)



510031

	€		
6	37,03	5	510031

Juego de destornilladores Phillips de precisión, PH000-PH0 (3 piezas)



510033

	€		
3	24,41	5	510033

DESTORNILLADORES CON MANGO EN T

Juego 6 destornilladores mango en T hexagonales



903T-1

	€		
6	76,66	1	903T-1

900T-030-100, 900T-040-150, 900T-050-150, 900T-060-200, 900T-080-200, 900T-100-200

Juego 6 destornilladores mango en T, TORX®



903T-2

	€		
6	70,74	1	903T-2

901T-015-150, 901T-020-150, 901T-010-100, 901T-030-200, 901T-040-200, 901T-025-150



Juego 6 destornilladores mango en T, Stecker



903T-3



€



6

87,63

1

903T-3

902T-060-150, 902T-070-175, 902T-050-150, 902T-080-175, 902T-100-175, 902T-130-175

Destornillador con mango en T hexagonal



900T



€



Bit Size	Length	Width	Price	Quantity	Code
2 mm	100 mm	50 mm	10,41	5	900T-020-100
2.5 mm	100 mm	50 mm	10,41	5	900T-025-100
3 mm	100 mm	50 mm	10,41	5	900T-030-100
4 mm	138 mm	50 mm	11,63	5	900T-040-150
5 mm	138 mm	60 mm	12,09	5	900T-050-150
6 mm	185 mm	60 mm	12,85	5	900T-060-200
8 mm	185 mm	60 mm	14,09	5	900T-080-200
10 mm	185 mm	60 mm	15,61	5	900T-100-200

Destornillador con mango en T TORX®



901T



€



Bit Size	Length	Width	Price	Quantity	Code
T 6	100 mm	50 mm	7,54	5	901T-006-100
T 7	100 mm	50 mm	7,54	5	901T-007-100
T 8	100 mm	50 mm	7,54	5	901T-008-100
T 9	100 mm	50 mm	7,54	5	901T-009-100
T 10	100 mm	50 mm	10,69	5	901T-010-100
T 15	138 mm	50 mm	10,88	5	901T-015-150
T 20	138 mm	50 mm	10,88	5	901T-020-150
T 25	138 mm	60 mm	11,93	5	901T-025-150
T 27	138 mm	60 mm	11,93	5	901T-027-150
T 30	185 mm	60 mm	12,85	5	901T-030-200

BAHCO

			€		
T 40	185 mm	60 mm	13,45	5	901T-040-200
T 45	185 mm	60 mm	13,45	5	901T-045-200
T 50	185 mm	60 mm	13,45	5	901T-050-200

Destornillador con mango en T Stecker



902T



€



Bit Size	Length	Width	Price	Quantity	Code
5 mm	136 mm	50 mm	12,49	5	902T-050-150
5.5 mm	136 mm	50 mm	12,49	5	902T-055-150
6 mm	136 mm	50 mm	13,32	5	902T-060-150
7 mm	160 mm	60 mm	14,09	5	902T-070-175
8 mm	160 mm	60 mm	14,36	5	902T-080-175
9 mm	160 mm	60 mm	14,36	5	902T-090-175
10 mm	160 mm	60 mm	15,30	5	902T-100-175
11 mm	160 mm	60 mm	15,30	5	902T-110-175
12 mm	160 mm	60 mm	17,14	5	902T-120-175
13 mm	160 mm	60 mm	18,06	5	902T-130-175

Porta vasos mango en T, 1/4"



905T



€



Bit Size	Length	Width	Price	Quantity	Code
1/4"	45 mm	60 mm	16,08	5	905T-060-100

DESTORNILLADORES PORTAPUNTAS DE 1/4"

Destornillador Portapuntas Magnetico 1/4" BahcoFit



B705



€



Bit Size	Length	Width	Price	Quantity	Code
1/4" in	125 mm	30 mm	12,00	5	B705.1/4.125
1/4" in	125 mm	30 mm	12,73	1	SB705.1/4.125

SB: Presentación en clip

Destornillador porta puntas con mango en T



904T



1/4 in	150 mm	€	5	904T-060-150

Destornillador con mango de madera



9778



	80 mm	24 mm	€	10	9778-1
PH 1	80 mm	24 mm	7,85	10	9778-1
PH 2	110 mm	27 mm	10,73	10	9778-2
PH 3	150 mm	30 mm	14,48	5	9778-3

Portapuntas 1/4"



808050A/TORX



1/4 in	115 mm	40 mm	€	1	808050A
1/4 in	115 mm	40 mm	26,73	50	808050TORX

Destornillador con mango de madera



9778PZD



	80 mm	24 mm	€	10	9778PZD-1
PZ 1	80 mm	24 mm	8,19	10	9778PZD-1
PZ 2	110 mm	27 mm	11,16	10	9778PZD-2

DESTORNILLADORES CON MANGO DE MADERA O PLASTICO

Destornillador para tornillos ranurados



9710



3.5 mm	75 mm	22 mm	€	10	9710-3.5-75
5.5 mm	100 mm	24 mm	7,24	10	9710-5.5-100
6.5 mm	125 mm	27 mm	8,36	10	9710-6.5-125
8.0 mm	150 mm	30 mm	9,64	5	9710-8-150
10.0 mm	175 mm	32 mm	11,55	5	9710-10-175

Juego de 6 destornilladores con mango de madera



9710/S6



6	€	1	9710/S6
6	52,16	1	9710/S6

9710-4.5-90
9710-5.5-100, 9710-6.5-125, 9710-8-150
9778-1, 9778-2

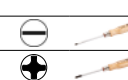

Destornillador reversible



1019/1067



Ø	Tip	€	Stack	Fish
4,5 mm	PH 1	3,49	10	1067
6 mm	PH 2	4,63	10	1019

1019: mango de acetato (naranja) 13561: mango de polipropileno (negro)

Destornillador varilla reversible



8052



Tip	Length	Shaft	€	Stack	Fish
PH 2	80 mm	28 mm	28,73	5	8052

Destornillador extracorto varilla reversible



1016



Ø	Tip	€	Stack	Fish
6 mm	PH 2	4,69	10	1016

Para tornillos phillips y planos

Juego de destornillador con 6 varillas reversibles



6



Tip	Length	€	Stack	Fish
PH 0, PH 1, PH 2	3,5-5,0-6,5 mm	17,61	1	6

Destornillador varilla pasante



9715



Ø	Length	Shaft	€	Stack	Fish
14,0 mm	250 mm	32 mm	44,67	5	9715-14-250

Destornillador de electrónica para tornillos ranurados



7372I



Ø	Length	Shaft	€	Stack	Fish
2.0 mm	63 mm	13 mm	13,17	10	7372I-2-63
2.5 mm	75 mm	13 mm	13,17	10	7372I-2.5-75
3.0 mm	80 mm	13 mm	13,17	10	7372I-3-80

COMPROBADORES ELÉCTRICOS

Destornillador aislado, comprobador de tensión



806



			€		
3.0 mm	65 mm	16 mm	4,56	6	806-1-1
3.5 mm	100 mm	17.5 mm	5,96	6	806-1-2

Comprobador 6-24V

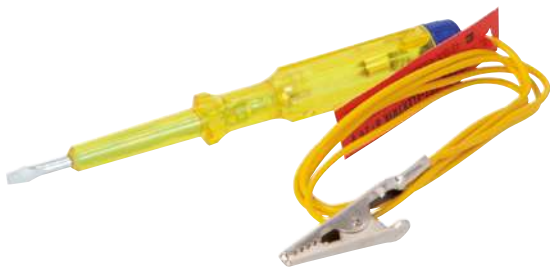

806-1-3



			€		
3 mm	45 mm	16 mm	6,04	6	806-1-3

Destornillador aislado, comprobador de tensión



8045VDE



			€		
3.5 mm	77 mm	14 mm	17,12	10	8045VDE

Destornillador aislado, comprobador de tensión



8045LVDE



			€		
3.5 mm	42 mm	16 mm	20,96	10	8045LVDE

IMANTADOR DESTORNILLADORES

Imantador - Desimantador



M780

	€		
29 x 52 x 50 mm	20,42	1	M780

Magnetizador - Desmagnetizador



M781

	€		
22 x 125 x 40 mm	12,91	5	M781





BAHCO



Llaves tipo allen



CON PUNTA HEXAGONAL

Llave tipo allen hexagonal acodada, niquelada



1998M

Ø	L	€	Icon	Icon
1.5 mm	47 mm	0,60	10	1998M-1.5
2 mm	52 mm	0,62	10	1998M-2
2.5 mm	59 mm	0,66	10	1998M-2.5
3.0 mm	66 mm	0,86	10	1998M-3
4.0 mm	74 mm	0,77	10	1998M-4
5.0 mm	85 mm	1,07	10	1998M-5
6.0 mm	96 mm	1,31	10	1998M-6
7.0 mm	102 mm	1,84	10	1998M-7
8.0 mm	108 mm	2,11	10	1998M-8
9.0 mm	114 mm	2,82	5	1998M-9
10 mm	122 mm	2,94	10	1998M-10
12.0 mm	137 mm	4,32	5	1998M-12
14.0 mm	154 mm	5,84	1	1998M-14
17.0 mm	177 mm	9,24	1	1998M-17
19.0 mm	199 mm	13,86	1	1998M-19
22.0 mm	222 mm	20,55	1	1998M-22

Juego de 6 llaves tipo allen, métrica, acabado niquelado



1998M/

Ø	Icon	€	Icon	Icon
2, 2.5, 3, 4, 5, 6 mm	X	7,29	1	1998M/6T

1998M-4, 1998M-5, 1998M-6, 1998M-2.5, 1998M-2, 1998M-3

Juego de 8 llaves tipo allen hexagonales acodadas niqueladas



1998M/8T

Ø	Icon	€	Icon	Icon
2, 2.5, 3, 4, 5, 6, 7, 8 mm	X	11,72	1	1998M/8T

1998M-3, 1998M-2, 1998M-6, 1998M-7, 1998M-4, 1998M-5, 1998M-8, 1998M-2.5

Juego de 10 llaves tipo allen niqueladas



1998M/10T

Ø	Icon	€	Icon	Icon
2, 2.5, 3, 4, 5, 6, 7, 8, 9, 10 mm	X	17,89	1	1998M/10T

Tamaños marcados en el envase para su fácil elección

1998M-5, 1998M-4, 1998M-7, 1998M-6, 1998M-2, 1998M-3, 1998M-2.5, 1998M-8, 1998M-9, 1998M-10

Juego de 11 llaves tipo allen hexagonales acodadas niqueladas



1998M/11T

Ø	Icon	€	Icon	Icon
2, 2.5, 3, 4, 5, 6, 7, 8, 9, 10, 12 mm	X	23,18	1	1998M/11T

1998M-5, 1998M-4, 1998M-7, 1998M-6, 1998M-2, 1998M-3, 1998M-2.5, 1998M-8, 1998M-9, 1998M-10, 1998M-12

Juego de 15 llaves tipo allen hexagonales acodadas niqueladas



1998M/15T

Ø	Icon	€	Icon	Icon
2, 2.5, 3, 4, 5, 6, 7, 8, 9, 10, 12, 14, 17, 19, 22 mm	X	75,84	1	1998M/15T

1998M-2, 1998M-5, 1998M-4, 1998M-7, 1998M-6, 1998M-3, 1998M-2.5, 1998M-14, 1998M-17, 1998M-19, 1998M-22, 1998M-8, 1998M-9, 1998M-10, 1998M-12

Juego de 9 llaves tipo allen hexagonales acodadas niqueladas



BE-9878

Ø	Icon	€	Icon	Icon
1.5, 2, 2.5, 3, 4, 5, 6, 8, 10 mm	X	14,44	1	BE-9878

1998M-1.5, 1998M-2.5, 1998M-2, 1998M-3, 1998M-4, 1998M-5, 1998M-6, 1998M-8, 1998M-10

Juego 8 llaves tipo allen hexagonales acodadas en aro, niqueladas



1998M/8R

Ø	Icon	€	Icon	Icon
2, 2.5, 3, 4, 5, 6, 7, 8 mm	X	12,72	1	1998M/8R

2, 2.5, 3, 4, 5, 6, 7, 8 mm 2, 2.5, 3, 4, 5, 6, 7, 8 mm

Juego de 7 llaves tipo allen hexagonales acodadas



1999M/7H

Ø	Icon	€	Icon	Icon
2.5 3 4 5 6 8 10 mm	X	32,77	1	1999M/7H

2.5, 3, 4, 5, 6, 8, 10

Juego 12 llaves tipo allen hex niqueladas serie larga, pulgadas



BE-9880

Icon	Icon X	€	Icon	Icon
0.050; 1/16; 5/64; 3/32; 7/64; 1/8; 9/64; 5/32; 3/16; 7/32; 1/4; 5/16 in	12	38,37	3	BE-9880

Llave tipo allen acodada pavonada



1995M

Icon	L	€	Icon	Icon
0.9 mm	33 mm	0,80	10	1995M-0.9
1.5 mm	47 mm	0,50	10	1995M-1.5
2.0 mm	52 mm	0,55	10	1995M-2
2.5 mm	59 mm	0,57	10	1995M-2.5
3.0 mm	66 mm	0,76	10	1995M-3
4.0 mm	74 mm	0,86	10	1995M-4
5.0 mm	85 mm	0,82	10	1995M-5
6.0 mm	96 mm	1,03	10	1995M-6
7.0 mm	102 mm	1,47	10	1995M-7
8.0 mm	108 mm	1,84	10	1995M-8
9.0 mm	114 mm	2,12	10	1995M-9
10 mm	122 mm	2,37	10	1995M-10
12 mm	137 mm	3,83	10	1995M-12
14 mm	154 mm	5,40	10	1995M-14
17 mm	177 mm	8,66	10	1995M-17
19 mm	199 mm	13,05	10	1995M-19
22 mm	222 mm	19,45	10	1995M-22

Llave acodada, pulgadas, pavonada



1995Z

Icon	L	€	Icon	Icon
1/16 in	47 mm	0,54	10	1995Z-1/16
5/64 in	52 mm	0,44	10	1995Z-5/64
3/32 in	59 mm	0,47	10	1995Z-3/32

Icon	L	€	Icon	Icon
1/8 in	66 mm	0,60	10	1995Z-1/8
5/32 in	74 mm	0,74	10	1995Z-5/32
3/16 in	85 mm	0,84	10	1995Z-3/16
7/32 in	91 mm	0,97	10	1995Z-7/32
1/4 in	96 mm	1,19	10	1995Z-1/4
5/16 in	108 mm	2,00	10	1995Z-5/16
3/8 in	122 mm	2,89	10	1995Z-3/8
7/16 in	129 mm	4,43	10	1995Z-7/16
1/2 in	145 mm	5,42	10	1995Z-1/2
5/8 in	168 mm	9,79	10	1995Z-5/8
3/4 in	199 mm	16,52	10	1995Z-3/4

Juego de 6 llaves tipo allen hexagonales acodadas pavonadas



1995M/6T

Icon	Icon X	€	Icon	Icon
2, 2.5, 3, 4, 5, 6 mm	6	5,59	1	1995M/6T

1995M-2, 1995M-2.5, 1995M-6, 1995M-5, 1995M-4, 1995M-3

Juego de 8 llaves tipo allen hexagonales acodadas pavonadas



1995M/8T

Icon	Icon X	€	Icon	Icon
2, 2.5, 3, 4, 5, 6, 7, 8 mm	8	10,34	1	1995M/8T

1995M-2.5, 1995M-2, 1995M-6, 1995M-5, 1995M-4, 1995M-3, 1995M-7, 1995M-8

Juego de 10 llaves tipo allen pavonadas hexagonal, mm



1995M/10T

Icon	Icon X	€	Icon	Icon
2, 2.5, 3, 4, 5, 6, 7, 8, 9, 10 mm	10	16,71	1	1995M/10T

1995M-2.5, 1995M-2, 1995M-6, 1995M-5, 1995M-4, 1995M-3, 1995M-9, 1995M-10, 1995M-7, 1995M-8

Juego de 11 llaves tipo allen pavonadas hexagonales, mm



1995M/11T

Icon	Icon X	€	Icon	Icon
2, 2.5, 3, 4, 5, 6, 7, 8, 9, 10, 12 mm	11	20,55	1	1995M/11T

1995M-2, 1995M-6, 1995M-5, 1995M-4, 1995M-2.5, 1995M-3, 1995M-9, 1995M-10, 1995M-7, 1995M-8, 1995M-12

Juego de 15 llaves tipo allen pavonadas hexagonales, mm



1995M/15T

Icon	Icon X	€	Icon	Icon
2, 2.5, 3, 4, 5, 6, 7, 8, 9, 10, 12, 14, 17, 19, 22 mm	15	70,42	1	1995M/15T

1995M-2.5, 1995M-2, 1995M-6, 1995M-5, 1995M-4, 1995M-3, 1995M-9, 1995M-10, 1995M-7, 1995M-8, 1995M-17, 1995M-19, 1995M-12, 1995M-14, 1995M-22



Juego de 9 llaves tipo allen hexagonales acodadas pavonadas



BE-9578

		€		
1.5, 2, 2.5, 3, 4, 5, 6, 8, 10 mm	9	13,04	1	BE-9578

1995M-2,5, 1995M-2, 1995M-1,5, 1995M-6, 1995M-5, 1995M-4, 1995M-3, 1995M-8, 1995M-10

Juego de 7 llaves tipo allen hexagonales acodadas



BE-9777B

		€		
2.5 3 4 5 6 8 10 mm	7	23,49	6	BE-9777B

2.5, 3, 4, 5, 6, 8, 10 mm

Juego de 7 llaves tipo allen hexagonales



BE-9776

	€		
1.5 2 2.5 3 4 5 6 mm	18,06	6	BE-9776

1.5, 2, 2.5, 3, 4, 5, 6 mm

Juego de 7 llaves tipo allen hexagonales en navaja



BE-9777

		€		
2.5 3 4 5 6 8 10 mm	7	24,49	6	BE-9777

2.5, 3, 4, 5, 6, 8, 10 mm

Juego de 10 llaves tipo allen hex pavonadas, pulgadas



1995Z/

		€		
1/16, 5/64, 3/32, 1/8, 5/32, 3/16, 7/32, 1/4, 5/16, 3/8 in	10	13,79	1	1995Z/10T

1995Z-1/16, 1995Z-5/64, 1995Z-3/32, 1995Z-1/8, 1995Z-5/32, 1995Z-3/16, 1995Z-3/8, 1995Z-7/32, 1995Z-1/4, 1995Z-5/16

Juego de 12 llaves tipo allen pavonadas, pulgadas



1995Z/12T

		€		
1/16, 5/64, 3/32, 1/8, 5/32, 3/16, 7/32, 1/4, 5/16, 3/8, 7/16, 1/2 in	12	22,45	1	1995Z/12T

1995Z-1/16, 1995Z-5/64, 1995Z-3/32, 1995Z-1/8, 1995Z-5/32, 1995Z-3/16, 1995Z-1/2, 1995Z-7/16, 1995Z-3/8, 1995Z-7/32, 1995Z-1/4, 1995Z-5/16

Juego de 7 llaves tipo allen hexagonales



BE-9787

		€		
3/32 1/8 5/32 3/16 1/4 5/16 3/8 in	7	25,91	6	BE-9787

Llave acodada pavonada serie larga, mm



1995LM

	L	€		
1.5 mm	91 mm	0,70	10	1995LM-1.5
2 mm	102 mm	0,51	10	1995LM-2
2.5 mm	114 mm	0,61	10	1995LM-2,5
3.0 mm	129 mm	0,80	10	1995LM-3
4.0 mm	144 mm	0,92	10	1995LM-4
5.0 mm	165 mm	1,35	10	1995LM-5
6.0 mm	186 mm	2,02	10	1995LM-6
7.0 mm	197 mm	2,66	10	1995LM-7
8.0 mm	208 mm	3,46	10	1995LM-8
9.0 mm	219 mm	4,32	10	1995LM-9
10 mm	234 mm	4,86	10	1995LM-10
12 mm	262 mm	7,29	10	1995LM-12
14 mm	294 mm	9,00	10	1995LM-14

Juego de 6 llaves tipo allen hexagonales acodadas pavonadas



BE-9586

		€		
1.5, 2, 2.5, 3, 4, 5 mm	6	10,06	1	BE-9586

1995LM-1.5, 1995LM-3, 1995LM-2,5, 1995LM-2, 1995LM-4, 1995LM-5

Juego de 9 llaves tipo allen serie larga



BE-9588

		€		
1.5, 2, 2.5, 3, 4, 5, 6, 8, 10 mm	9	20,67	1	BE-9588

1995LM-1.5, 1995LM-2, 1995LM-2.5, 1995LM-3, 1995LM-4, 1995LM-5, 1995LM-6, 1995LM-8, 1995LM-10

Llave tipo allen acodada, con bola, pavonada



1996M

		€		
1.5 mm	91 mm	1,62	10	1996M-1.5
2.0 mm	102 mm	1,80	10	1996M-2
2.5 mm	114 mm	1,63	10	1996M-2.5
3.0 mm	129 mm	1,68	10	1996M-3
4.0 mm	144 mm	2,00	10	1996M-4
5.0 mm	165 mm	3,27	10	1996M-5
6.0 mm	186 mm	3,72	10	1996M-6
8.0 mm	208 mm	5,24	10	1996M-8
10 mm	234 mm	9,39	10	1996M-10
12 mm	262 mm	10,04	5	1996M-12

Juego de 9 llaves tipo allen hexagonales de colores con bola



C1997LM/9P

		€		
1.5, 2, 2.5, 3, 4, 5, 6, 8, 10 mm	9	36,77	1	C1997LM/9P

Juego de 6 llaves tipo allen hexagonales acodadas con bola pavonadas



BE-9765

		€		
1.5, 2, 2.5, 3, 4, 5 mm	6	10,75	3	BE-9765

1996M-1.5, 1996M-2.5, 1996M-2, 1996M-4, 1996M-3, 1996M-5

Juego de 9 llaves tipo allen pavonadas hex bola, mm



BE-9770

		€		
1.5, 2, 2.5, 3, 4, 5, 6, 8, 10 mm	9	17,72	3	BE-9770

1996M-1.5, 1996M-2.5, 1996M-2, 1996M-4, 1996M-3, 1996M-5, 1996M-6, 1996M-10, 1996M-8

Juego de 6 llaves tipo allen hexagonales acodadas con bola pavonadas



BE-9676

		€		
1.5, 2, 2.5, 3, 4, 5 mm	6	17,43	1	BE-9676

1996M-5, 1996M-4, 1996M-3, 1996M-2.5, 1996M-2, 1996M-1.5

Juego de 9 llaves tipo allen pavonadas Hex Bola serie larga



BE-9678

		€		
1.5, 2, 2.5, 3, 4, 5, 6, 8, 10 mm	9	32,28	1	BE-9678

1996M-4, 1996M-5, 1996M-2.5, 1996M-3, 1996M-10, 1996M-6, 1996M-8, 1996M-2, 1996M-1.5

Juego de llaves tipo allen hexagonales acodadas con bola



BE-9688

		€		
1.5, 2, 2.5, 3, 4, 5, 6, 8, 10 mm	9	34,47	1	BE-9688

1996M-1.5, 1996M-2, 1996M-2.5, 1996M-3, 1996M-4, 1996M-5, 1996M-6, 1996M-8, 1996M-10

Juego de 7 llaves tipo allen con bola en navaja



BE-9776B

		€		
2.5, 3, 4, 5, 6, 8, 10 mm	7	34,92	6	BE-9776B



Juego de 7 llaves tipo allen hexagonales



BE-9775

		€			
1/16, 5/64, 3/32, 1/8, 5/32, 3/16, 1/4 in	7	15,89	3	BE-9775	

5/64 3/32 1/4 1/8 1/16 5/32 3/16

Juego de 12 llaves tipo allen hex bola serie larga, pulgadas



BE-9780

		€			
0.05 1/16 5/64 3/32 7/64 1/8 9/64 5/32 3/16 7/32 1/4 5/16 in	12	29,29	3	BE-9780	

0.05 1/16 5/64 3/32 7/64 1/8 9/64 5/32 3/16 7/32 1/4 5/16

Juego de 13 llaves tipo allen hex bola serie larga, pulgadas



BE-9785

		€			
0.05 1/16 5/64 3/32 7/64 1/8 9/64 5/32 3/16 7/32 1/4 5/16 3/8 in	13	27,13	3	BE-9785	

0.05 1/16 5/64 3/32 7/64 1/8 9/64 5/32 3/16 7/32 1/4 5/16 3/8

CON PUNTA TORX®

Llave tipo allen TORX, pavonada



1995TORX

		€			
T 6	75 mm	6,26	5	1995TORX-T6	
T 7	80 mm	6,26	5	1995TORX-T7	
T 8	80 mm	6,26	5	1995TORX-T8	
T 9	80 mm	5,93	5	1995TORX-T9	
T 10	86 mm	5,07	5	1995TORX-T10	
T 15	90 mm	5,17	5	1995TORX-T15	
T 20	95 mm	5,38	5	1995TORX-T20	
T 25	100 mm	5,40	5	1995TORX-T25	
T 27	105 mm	5,52	5	1995TORX-T27	
T 30	114 mm	5,61	5	1995TORX-T30	
T 40	124 mm	5,88	5	1995TORX-T40	
T 45	133 mm	6,13	5	1995TORX-T45	
T 50	152 mm	6,96	5	1995TORX-T50	
T 55	184 mm	9,89	5	1995TORX-T55	
T 60	204 mm	12,00	5	1995TORX-T60	

Juego 9 llaves tipo allen TORX® de colores



C1997TORX/9P

		€			
8, 9, 10, 15, 20, 25, 27, 30, 40	9	36,77	1	C1997TORX/9P	

Juego 4 llaves tipo allen TORX®



1995TORX/

		€			
10, 20, 30, 40	4	24,64	1	1995TORX/4T	

1995TORX-T40, 1995TORX-T30, 1995TORX-T10, 1995TORX-T20



Juego de 7 llaves tipo allen pavonadas TORX®



1995TORX/7T

		€			
10, 15, 20, 25, 27, 30, 40	7	40,18	1	1995TORX/7T	

1995TORX-T20, 1995TORX-T10, 1995TORX-T15, 1995TORX-T27, 1995TORX-T25, 1995TORX-T30, 1995TORX-T40



Juego de 11 llaves tipo allen pavonadas TORX®



1995TORX/11T

		€			
7, 9, 10, 15, 20, 25, 27, 30, 40, 45, 50	11	67,32	1	1995TORX/11T	

1995TORX-T7, 1995TORX-T9, 1995TORX-T10, 1995TORX-T15, 1995TORX-T20, 1995TORX-T25, 1995TORX-T27, 1995TORX-T30, 1995TORX-T40, 1995TORX-T45, 1995TORX-T50



Juego de 13 llaves tipo allen pavonadas TORX®, mm



1995TORX/13T

		€		
6, 7, 8, 9, 10, 15, 20, 25, 27, 30, 40, 45, 50	13	80,83	1	1995TORX/13T

1995TORX-T45, 1995TORX-T40, 1995TORX-T30, 1995TORX-T27, 1995TORX-T25, 1995TORX-T20, 1995TORX-T15, 1995TORX-T10, 1995TORX-T50, 1995TORX-T8, 1995TORX-T9, 1995TORX-T6, 1995TORX-T7

Juego de 8 llaves tipo allen TORX® pavonadas



BE-9575

		€		
T9, T10, T15, T20, T25, T27, T30, T40	8	46,06	1	BE-9575

1995TORX-T40, 1995TORX-T30, 1995TORX-T27, 1995TORX-T25, 1995TORX-T20, 1995TORX-T15, 1995TORX-T10, 1995TORX-T9

Juego de 8 llaves tipo allen TORX® pavonadas



BE-9585

		€		
T9, T10, T15, T20, T25, T27, T30, T40	8	48,85	1	BE-9585

1995TORX-T30, 1995TORX-T27, 1995TORX-T25, 1995TORX-T20, 1995TORX-T15, 1995TORX-T10, 1995TORX-T9, 1995TORX-T40

Juego de 8 llaves tipo allen pavonadas TORX®



BE-8975B

		€		
T 9 - T 10 - T 15 - T 20 - T 25 - T 27 - T 30 - T 40	8	41,81	6	BE-8975B

Juego de 8 llaves para tornillos TORX®



BE-8975

		€		
T 9 10 15 20 25 27 30 40	8	41,81	6	BE-8975

Llave acodada TORX®, con bola, pavonada



1996TORX

		€		
T 9	80 mm	7,70	5	1996TORX-T9
T 10	86 mm	8,88	5	1996TORX-T10
T 15	90 mm	9,17	5	1996TORX-T15
T 20	95 mm	9,31	5	1996TORX-T20

		€		
T 25	100 mm	9,46	5	1996TORX-T25
T 27	105 mm	9,52	5	1996TORX-T27
T 30	114 mm	9,97	5	1996TORX-T30
T 40	124 mm	10,63	5	1996TORX-T40
T 45	133 mm	11,14	5	1996TORX-T45
T 50	152 mm	12,62	5	1996TORX-T50

Juego 5 llaves tipo allen TORX® con bola



1996TORX/

		€		
T10, T20, T25, T30, T40	5	46,89	1	1996TORX/5T

1996TORX-T10, 1996TORX-T20, 1996TORX-T25, 1996TORX-T30, 1996TORX-T40

Juego de 8 llaves Torx® acodadas con bola, pavonadas



BE-9675

		€		
T9, T10, T15, T20, T25, T27, T30, T40	8	67,02	1	BE-9675

1996TORX-T10, 1996TORX-T9, 1996TORX-T15, 1996TORX-T20, 1996TORX-T25, 1996TORX-T27, 1996TORX-T30, 1996TORX-T40



Llave acodada TORX® inviolable, pavonada



1986TORX

	L	€		
TR 9	80 mm	8,44	5	1986TORX-T9
TR 10	86 mm	8,74	5	1986TORX-T10
TR 15	90 mm	8,96	5	1986TORX-T15
TR 20	95 mm	9,08	5	1986TORX-T20
TR 25	100 mm	9,24	5	1986TORX-T25
TR 27	105 mm	9,31	5	1986TORX-T27
TR 30	114 mm	9,69	5	1986TORX-T30
TR 40	124 mm	10,34	5	1986TORX-T40

Juego 7 llaves tipo allen TORX® inviolable



1986TORX/

	X	€		
TR10, TR15, TR20, TR25, TR27, TR30, TR40	7	68,80	1	1986TORX/7T

1986TORX-T10, 1986TORX-T15, 1986TORX-T20, 1986TORX-T25, 1986TORX-T27, 1986TORX-T30, 1986TORX-T40

Juego de 8 llaves tipo allen TORX® inviolables



BE-8675

	X	€		
T9, T10, T15, T20, T25, T27, T30, T40	8	75,09	1	BE-8675

1986TORX-T10, 1986TORX-T9, 1986TORX-T20, 1986TORX-T15, 1986TORX-T30, 1986TORX-T40, 1986TORX-T25, 1986TORX-T27

Juego de 8 llaves TORX® acodadas



BE-8976B

	X	€		
T9, T10, T15, T20, T25, T27, T30, T40	8	47,49	6	BE-8976B

Llave acodada TORX PLUS®, pavonada



1976TORX

	L	€		
IP 6	75 mm	7,62	5	1976TORX-T6
IP 7	80 mm	7,62	5	1976TORX-T7
IP 8	80 mm	7,62	5	1976TORX-T8
IP 9	80 mm	7,39	5	1976TORX-T9
IP 10	86 mm	7,71	5	1976TORX-T10
IP 15	90 mm	7,93	5	1976TORX-T15
IP 20	95 mm	8,02	5	1976TORX-T20
IP 25	100 mm	8,13	5	1976TORX-T25
IP 27	105 mm	9,01	5	1976TORX-T27
IP 30	114 mm	9,45	5	1976TORX-T30
IP 40	124 mm	10,09	5	1976TORX-T40

Juego 5 llaves tipo allen TORX PLUS® pavonadas



1976TORX/

	X	€		
IP 10, IP 20, IP 25, IP 30, IP 40	5	41,22	1	1976TORX/5T

1976TORX-T10, 1976TORX-T20, 1976TORX-T25, 1976TORX-T40, 1976TORX-T30

Juego de 8 llaves TORX PLUS® acodada pavonada



BE-7675

	X	€		
IP9, IP10, IP15, IP20, IP25, IP27, IP30, IP40	8	62,41	1	BE-7675

1976TORX-T10, 1976TORX-T9, 1976TORX-T15, 1976TORX-T20, 1976TORX-T25, 1976TORX-T30, 1976TORX-T40, 1976TORX-T27

ACODADAS

Destornillador acodado boca recta



2047

Ø	L	€		
4.0 mm	100 mm	6,37	5	2047-0.8-4
5.5 mm	125 mm	7,77	5	2047-1.5-5
8.0 mm	150 mm	9,95	5	2047-1.2-8
10.0 mm	175 mm	13,66	1	2047-1.6-10
12.0 mm	200 mm	19,91	1	2047-2-12

Destornillador acodado doble boca para tornillos Pozidriv



2047PZ

+	L	€		
PZ1, PZ2	100 mm	8,19	5	2047PZ-1-2

MULTIHERRAMIENTAS

Juego de herramientas para bicicleta



Destornillador acodado boca Phillips



2047PR

+	L	€		
PH 1 & 2	100 mm	8,00	5	2047PR-1-2
PH 3 & 4	200 mm	13,22	5	2047PR-3-4

BKE850901N

€		
200 x 35 x 170 mm	14,99	10 BKE850901N





BAHCO



Alicates



ALICATES DE CORTE

Alicate de corte diagonal con filos progresivos



ergo®



2101G

Cu	Fe+	Plano	€	PL	IP
3.5 mm	1.8 mm	1.6 mm	24,00	5	2101G-125
3.7 mm	2.0 mm	1.8 mm	24,42	5	2101G-140
3.8 mm	2.5 mm	2.0 mm	24,92	5	2101G-160
4.0 mm	2.7 mm	2.3 mm	26,66	5	2101G-180
3.5 mm	1.8 mm	1.6 mm	22,42	5	2101G-125IP
3.7 mm	2.0 mm	1.8 mm	22,83	5	2101G-140IP
3.8 mm	2.5 mm	2.0 mm	23,37	5	2101G-160IP
4.0 mm	2.7 mm	2.3 mm	25,04	5	2101G-180IP

IP: Embalaje industrial

Alicate de corte diagonal con filos progresivos



ergo®



2101G_D

Cu	Fe+	Plano	€	PL	IP
3.5 mm	1.8 mm	1.6 mm	22,42	5	2101G-125IPD
3.7 mm	2.0 mm	1.8 mm	22,83	5	2101G-140IPD
3.8 mm	2.5 mm	2.0 mm	23,37	5	2101G-160IPD
4.0 mm	2.7 mm	2.3 mm	25,04	5	2101G-180IPD

Alicate de corte diagonal para plástico



ergo®



2101PG

L	€	PL	IP
160 mm	53,99	5	2101PG-160

BAHCO

Alicate de corte lateral cromado plateado con filos progresivos



ergo®



2101GC

Cu	Fe+	Plano	€	PL	IP
3.5 mm	1.8 mm	1.6 mm	22,78	5	2101GC-125IP
3.7 mm	2.0 mm	1.8 mm	22,90	5	2101GC-140IP
3.8 mm	2.5 mm	2.0 mm	23,85	5	2101GC-160IP
4.0 mm	2.7 mm	2.3 mm	25,99	5	2101GC-180IP

IP: Embalaje industrial

Alicates de corte diagonal con filo progresivo



2101D

Cu	Fe+	Plano	€	PL	IP
3.5 mm	1.8 mm	1.6 mm	20,07	5	2101D-125
3.7 mm	2.0 mm	1.8 mm	20,07	5	2101D-140
3.8 mm	2.5 mm	2.0 mm	20,41	5	2101D-160
4.0 mm	2.7 mm	2.3 mm	22,20	5	2101D-180
3.5 mm	1.8 mm	1.6 mm	18,48	5	2101D-125IP
3.7 mm	2.0 mm	1.8 mm	18,48	5	2101D-140IP
3.8 mm	2.5 mm	2.0 mm	18,80	5	2101D-160IP
4.0 mm	2.7 mm	2.3 mm	20,60	5	2101D-180IP

IP: Embalaje industrial

Alicate cortante "Heavy Duty"



ergo®



21HDG

Fe+	Plano	L	€	PL	IP
2.3 mm	2.1 mm	140 mm	26,99	5	21HDG-140
2.7 mm	2.3 mm	160 mm	27,70	5	21HDG-160
3.3 mm	2.8 mm	180 mm	30,36	5	21HDG-180
3.3 mm	2.8 mm	200 mm	32,29	5	21HDG-200
2.3 mm	2.1 mm	140 mm	25,40	5	21HDG-140IP
2.7 mm	2.3 mm	160 mm	26,11	5	21HDG-160IP
3.3 mm	2.8 mm	180 mm	28,77	5	21HDG-180IP
3.3 mm	2.8 mm	200 mm	30,71	5	21HDG-200IP

IP: Embalaje industrial

Alicate corte diagonal angulado 14° para aplicaciones "Heavy Duty"



ergo®



21HDG-A

Fe+	Plano	L	€		
2.2 mm	2.0 mm	140 mm	28,63	5	21HDG-140A
2.5 mm	2.3 mm	160 mm	29,76	5	21HDG-160A
2.7 mm	2.5 mm	180 mm	32,61	5	21HDG-180A
3.2 mm	3.0 mm	200 mm	34,77	5	21HDG-200A

Alicate corte diagonal "Heavy Duty" cromado



ergo®



21HDGC

Fe+	Plano	L	€		
2.2 mm	2.2 mm	140 mm	26,58	5	21HDGC-140IP
2.5 mm	2.5 mm	160 mm	27,66	5	21HDGC-160IP
2.8 mm	2.8 mm	180 mm	30,04	5	21HDGC-180IP
3.2 mm	3.0 mm	200 mm	31,59	5	21HDGC-200IP

IP: Embalaje industrial

Alicate corte diagonal extra fuerte "Heavy Duty"



21HDD

Fe+	Plano	L	€		
2.2 mm	2.2 mm	140 mm	22,93	5	21HDD-140
2.5 mm	2.5 mm	160 mm	23,53	5	21HDD-160
2.8 mm	2.8 mm	180 mm	25,73	5	21HDD-180
3.2 mm	3.0 mm	200 mm	28,17	5	21HDD-200
2.2 mm	2.2 mm	140 mm	21,34	5	21HDD-140IP
2.5 mm	2.5 mm	160 mm	21,97	5	21HDD-160IP
2.8 mm	2.8 mm	180 mm	24,13	5	21HDD-180IP
3.2 mm	3.0 mm	200 mm	26,57	5	21HDD-200IP

P: Embalaje industrial

Mini cortavarillas, filos céntricos de precisión



1520G

Plano	L	€		
3.8 mm	210 mm	38,87	5	1520 G
3.8 mm	210 mm	38,77	5	1520 G IP

Extrafuerte, muy versátil
IP: Embalaje industrial

Alicate corte diagonal, filos céntricos de precisión



1520D

Plano	L	€		
3.8 mm	205 mm	43,84	5	1520 D

Alicate de corte diagonal



ergo®



4130, 4131





Fe+	L	€		
0.3-1.5 mm	120 mm	47,87	3	4130
0.3-1.5 mm	120 mm	47,87	3	4131



Alicate de corte diagonal, cabeza ovalada



C3140

		€			
0,4-2,0 mm	130 mm	36,36	10		C3140
0,4-2,0 mm	130 mm	35,95	10		C3140IP

P: Embalaje industrial

Alicate de corte diagonal para plástico



2100PD





			€			
1.8 mm	3.0 mm	150 mm	31,36	5		2100PD-150

Máx capacidad Cu1.8mm y plástico PA (Bylon) 3mm

Alicate corte diagonal, cabeza cónica y rebajada



C3330



		€			
0,3-1,6 mm	115 mm	35,29	10		C3330
0,3-1,6 mm	115 mm	34,88	10		C3330IP

P: Embalaje industrial

Alicate de corte lateral







2171G

			€			
2.5 mm	1.6 mm	1.5 mm	18,87	5		2171G-140
2.5 mm	1.6 mm	1.5 mm	19,47	5		2171G-160
2.5 mm	1.6 mm	1.5 mm	21,49	5		2171G-180

Alicate corte diagonal, cabeza rebajada



C3330R/C3340R

		€			
0,3-1,25 mm	115 mm	35,29	10		C3330R
0,3-1,25 mm	115 mm	34,88	10		C3330R IP
0,4-1,6 mm	130 mm	36,19	10		C3340R
0,4-1,6 mm	130 mm	36,24	10		C3340R IP

P: Embalaje industrial

Alicate de corte diagonal cromado



2666NB-2676NB

			€			
2.7 mm	2.0 mm	160 mm	82,39	1		2674 NB

Alicate de corte diagonal cromado



2667B-2678B

			€		
3.7 mm	2.0 mm	2.0 mm	85,24	1	2676 B
4.0 mm	2.5 mm	2.5 mm	95,22	1	2678 B

Alicate de corte diagonal de precisión



2646M - 2649

			€		
0.1-0.8 mm	Flush	108 mm	90,63	1	2646 M
0.2-1.25 mm	Micro-bevel	110 mm	76,82	1	2646 R
0.2-1.25 mm	Micro-bevel	110 mm	116,15	1	2646 RK
0.1-1.0 mm	Flush	110 mm	90,77	1	2646 RA
0.3-1.6 mm	Micro-bevel	112.5 mm	81,78	1	2666
0.4-2.0 mm	Micro-bevel	125 mm	87,60	1	2649

Alicate de corte diagonal de precisión



2646 - 2648A

			€		
0.2-1.25 mm	Micro-bevel	110 mm	81,78	1	2646
0.2-1.25 mm	Micro-bevel	110 mm	92,61	1	2646 K
0.1-1.0 mm	Ultra-flush	110 mm	93,07	1	2648 A

			€		
0.1-1.0 mm	Ultra-flush	110 mm	89,31	1	2646 AK
0.2-1.25 mm	Ultra-flush	112.5 mm	96,00	1	2666 FK
0.4-2.0 mm	Micro-bevel	125 mm	77,28	1	2648
0.3-1.6 mm	Ultra-flush	125 mm	110,33	1	2648 A

Alicate de corte oblicuo



ergo®



4231

		€		
0.3-1.25 mm	119 mm	65,81	3	4231

Alicate de corte oblicuo 45°



ergo®



4239

		€		
0.3-1.0 mm	129 mm	64,54	3	4239



Alicate de corte oblicuo para plástico



2145PD

PLASTIC

			€		
3.0 mm	1.8 mm	154 mm	50,54	5	2145PD-150

Alicate cortante frontal para cuerda de piano



527 GC

		€		
2.0 mm	160 mm	32,93	3	527 GC-160
2.5 mm	200 mm	39,32	3	527 GC-200

Alicate de corte oblicuo 45°



2787F

			€		
0.2-1.0 mm	Flush	117.5 mm	120,36	1	2787 F

Alicates de corte frontal pavonados



527D

		€		
2 mm	160 mm	26,42	5	527 D-160
2.5 mm	200 mm	31,56	5	527 D-200

Alicate de corte oblicuo 45°



2787G

			€		
0.2-0.8 mm	Flush	117.5 mm	131,42	1	2787 G

Tenaza rusa, alambre de hierro



2339D

		€		
2.2 mm	220 mm	20,18	3	2339 D
2.2 mm	220 mm	19,51	5	2339 DIP
4.5 mm	300 mm	24,44	5	2339D-300
4.5 mm	300 mm	23,85	6	2339D-300IP

IP: Embalaje industrial

Tenaza de encofrador, modelo ruso



2339

		€		
2.2 mm	220 mm	16,09	5	2339-220
2.2 mm	220 mm	15,50	5	2339-220IP
2.5 mm	250 mm	17,43	5	2339-250IP
3.0 mm	280 mm	19,83	5	2339-280IP
4.5 mm	300 mm	26,50	6	2339-300IP

IP: Embalaje industrial

Tenaza de carpintero, alambre de hierro



541D

		€		
2.0 mm	150 mm	16,62	5	541 D-150
2.0 mm	180 mm	17,81	5	541D-180
2.5 mm	200 mm	18,89	5	541 D-200
2.5 mm	225 mm	21,77	5	541D-225
2.5 mm	250 mm	24,77	5	541 D-250

Alicates de corte frontal pavonados



1519D

		€		
2.5 mm	230 mm	121,97	3	1519 D
		60,79	1	1519-9

Alicates de corte frontal



C3230

	€		
109 mm	49,18	10	C3230
109 mm	48,70	10	C3230IP

Alicates de corte oblicuo para plástico



2190PD

			€		
1.8 mm	3.0 mm	143 mm	53,43	5	2190PD-150

PLASTIC

Alicates de corte frontal



2656/2656A

			€		
0.35 - 0.8 mm	Micro	115 mm	84,98	1	2656



Cortacables y pelacables



2233D

Øa		L	€		
10 mm	50/35 mm	160 mm	33,36	5	2233 D-160
13 mm	70/50 mm	200 mm	40,98	5	2233 D-200
16 mm	95/70 mm	240 mm	46,23	5	2233 D-240
10 mm	50/35 mm	160 mm	32,68	5	2233D-160IP
13 mm	70/50 mm	200 mm	40,29	5	2233D-200IP
16 mm	95/70 mm	240 mm	45,55	5	2233D-240IP

P: Embalaje industrial

Cortacables



2520

L	€		
550 mm	175,48	1	2520

2520-SH: hojas de repuesto, tornillos y tuerca

Cortacables para cobre



2620-80

Øa	L	€		
42 mm	800 mm	283,66	1	2620-80

Cortacables de acero



2720

Øa	L	€		
42 mm	600 mm	243,06	1	2720
	163 mm	185,86	1	2720-SH

2720-SH: Hoja de repuesto para 2720

Cortacables de acero



2235-160

L	€		
165 mm	50,46	1	2235-160

Cortacables con carraca



2804-2805

Øa	Øb	L	€		
16 mm	34 mm	250 mm	436,26	1	2804
22 mm	52 mm	280 mm	510,21	1	2805-280

Cortacables



2800N-2801N

		€		
0-10 mm	170 mm	69,98	1	2800 N
0-15 mm	230 mm	86,23	1	2801 N

Cortavarillas



4559

			€		
6 mm	5 mm	4 mm	87,34	1	4559-12
8 mm	7 mm	6 mm	108,60	8	4559-18
10 mm	9 mm	8 mm	129,39	6	4559-24
13 mm	10 mm	9 mm	155,58	5	4559-30
15 mm	12 mm	11 mm	204,21	3	4559-36
15 mm	12 mm	11 mm	286,15	2	4559-42

Cabeza de corte de recambio para cortavarillas 4559



4559 JC

g	€		
285 g	53,77	1	4559-12A JC
600 g	69,51	1	4559-18B JC
930 g	82,81	1	4559-24B JC
1260 g	99,57	1	4559-30B JC
2180 g	130,70	1	4559-36B JC
3025 g	126,49	1	4559-42A JC

Cortavarillas de corte diagonal, mm



4560-210

	€		
250 mm	55,73	1	4560-210

ALICATES UNIVERSALES

Alicates universales



2628G

			€		
1.8 mm	2.0 mm	160 mm	24,76	5	2628 G-160
2.0 mm	2.5 mm	180 mm	27,17	5	2628 G-180
2.5 mm	3.0 mm	200 mm	28,98	5	2628 G-200
1.8 mm	2.0 mm	160 mm	24,06	5	2628 G-160IP
2.0 mm	2.5 mm	180 mm	26,50	5	2628 G-180IP
2.5 mm	3.0 mm	200 mm	28,30	5	2628G-200IP

IP: Embalaje industrial

Alicates universales, cromados



2628GC

			€		
2.0 mm	1.8 mm	160 mm	19,20	5	2628 GC-160IP
2.5 mm	2.0 mm	180 mm	20,74	5	2628 GC-180IP
3.0 mm	2.5 mm	200 mm	22,81	5	2628 GC-200IP

IP: Embalaje industrial



Alicates universales, mangos bimateriales



ergo®



2630GC

Plano	Fe*	L	€	P	Icono
1.8 mm	2.0 mm	160 mm	19,79	5	2630GC-160IP
2.0 mm	2.5 mm	180 mm	19,94	5	2630GC-180IP
2.5 mm	3.0 mm	200 mm	22,81	5	2630GC-200IP

Alicates universales, mangos recubiertos de PVC



2630DC

Fe*	Plano	L	€	P	Icono
2.0 mm	1.8 mm	160 mm	17,89	5	2630DC-160IP
2.5 mm	2.0 mm	180 mm	19,08	5	2630DC-180IP
3.0 mm	2.5 mm	200 mm	21,93	5	2630DC-200IP

Alicates ERGO™ universales con boca semirredonda



ergo®



2629G

L	Fe*	Plano	€	P	Icono
160 mm	2.0 mm	1.8 mm	24,76	5	2629G-160
180 mm	3.0 mm	2.5 mm	27,09	5	2629G-180
200 mm	2.5 mm	2.0 mm	28,98	5	2629G-200
160 mm	2.5 mm	2.0 mm	24,06	5	2629G-160IP
180 mm	2.0 mm	1.8 mm	26,50	5	2629G-180IP
200 mm	3.0 mm	2.5 mm	28,30	5	2629G-200IP

P: Embalaje industrial

Alicates universales, modelo americano



2640D

Cu*	Fe	Fe*	€	P	Icono
3.0 mm	2.7 mm	2.5 mm	19,22	10	2640D-160
3.0 mm	2.7 mm	2.5 mm	21,78	5	2640D-180
3.5 mm	3.0 mm	2.5 mm	24,47	5	2640D-200

Alicates universales, mangos recubiertos de PVC



2628D

Fe*	Plano	L	€	P	Icono
2.0 mm	1.8 mm	160 mm	20,81	5	2628 D-160
2.5 mm	2.0 mm	180 mm	23,80	5	2628 D-180
3.0 mm	2.5 mm	200 mm	25,04	5	2628 D-200

Alicates universales para electricista



2688D

Fe*	Fe	Cu*	€	P	Icono
2.5 mm	3.0 mm	3.5 mm	41,56	3	2688D-250

Alicates universales



2678G

			€		
1.7 mm	1.3 mm	160 mm	16,08	5	2678 G-160
2.0 mm	1.4 mm	180 mm	17,10	5	2678 G-180
2.5 mm	1.5 mm	205 mm	18,48	5	2678 G-200

Alicate de apertura múltiple



2970 G-200

	€		
200 mm	17,24	5	2970G-200

ALICATES DE MANIPULACIÓN

Alicate de boca semirredonda



ergo®



2430G

			€		
2.5 mm	1.8 mm	1.4 mm	27,09	5	2430 G-140
3.0 mm	1.8 mm	1.6 mm	28,61	5	2430 G-160
3.0 mm	1.8 mm	1.6 mm	32,82	5	2430 G-200
2.5 mm	1.8 mm	1.4 mm	26,41	5	2430 G-140 IP
3.0 mm	1.8 mm	1.6 mm	27,91	5	2430 G-160 IP
3.0 mm	1.8 mm	1.6 mm	32,13	5	2430 G-200 IP

IP: Embalaje industrial

Alicates de boca semirredonda cromado



ergo®



2430GC

			€		
2.5 mm	1.8 mm	1.4 mm	22,58	5	2430 GC-140 IP
3.0 mm	1.8 mm	1.6 mm	23,61	5	2430 GC-160 IP
3.0 mm	1.8 mm	1.6 mm	27,18	5	2430 GC-200 IP

IP: Embalaje industrial

Alicates de boca semirredonda largos, boca recta



2430D

			€		
2.5 mm	1.8 mm	1.4 mm	23,96	5	2430 D-140
3.0 mm	1.8 mm	1.6 mm	25,85	5	2430 D-160
3.0 mm	1.8 mm	1.6 mm	28,02	5	2430 D-200
2.5 mm	1.8 mm	1.4 mm	23,30	5	2430 D-140 IP
3.0 mm	1.8 mm	1.6 mm	25,13	5	2430 D-160 IP
3.0 mm	1.8 mm	1.6 mm	27,33	5	2430 D-200 IP

IP: Embalaje industrial

Alicates ERGO™ de boca semirredonda sin filo de corte



ergo®



2431G

	€		
125 mm	25,58	5	2431G-125
140 mm	26,11	5	2431G-140
160 mm	26,58	5	2431G-160
180 mm	27,55	5	2431G-180
125 mm	25,10	5	2431G-125IP
140 mm	25,55	5	2431G-140IP
160 mm	25,99	5	2431G-160IP
180 mm	26,82	5	2431G-180IP

IP: Embalaje industrial



Alicate de boca semirredonda



ergo®



4830, 4831

↔ L ↔	€		
135 mm	42,75	3	4830
135 mm	45,46	3	4831

Alicate de boca semirredonda



2656S

↔ L ↔	€		
132 mm	65,15	1	2656 S

Alicate de boca redonda



C3830/C3840

↔ L ↔	€		
121 mm	36,95	10	C3830
121 mm	36,22	10	C3830IP
144 mm	36,95	10	C3840
144 mm	36,24	10	C3840IP

IP: Embalaje industrial

Alicates de boca semiredonda



2470G

			€		
3.0 mm	1.5 mm	1.0 mm	18,30	5	2470 G-160
3.0 mm	1.5 mm	1.0 mm	20,33	5	2470 G-200

Alicate de boca redonda



C3630/C3640

↔ L ↔	€		
130 mm	41,13	10	C3630
130 mm	40,30	10	C3630IP
145 mm	42,33	10	C3640
145 mm	41,37	10	C3640IP

IP: Embalaje industrial

Alicate de boca semirredonda extra largo



158-N

↔ L ↔	€		
280 mm	37,14	12	158-N

Alicates de boca semirredonda, punta curva 45°



ergo®



2427G

			€		
3.0 mm	1.8 mm	1.6 mm	29,47	5	2427 G-160
3.0 mm	1.8 mm	1.6 mm	33,70	5	2427 G-200
3.0 mm	1.8 mm	1.6 mm	28,77	5	2427 G-160 IP
3.0 mm	1.8 mm	1.6 mm	33,03	5	2427 G-200 IP

IP: Embalaje industrial

Alicates de boca semirredonda, punta curva 45° - cromados



ergo®



2427GC

			€		
3.0 mm	1.8 mm	1.6 mm	24,56	5	2427 GC-160IP
3.0 mm	1.8 mm	1.6 mm	28,14	5	2427 GC-200IP

Alicates de boca semirredonda, punta curva 45°



2427D

			€		
3.0 mm	1.8 mm	1.6 mm	27,01	5	2427 D-160
3.0 mm	1.8 mm	1.6 mm	29,20	5	2427 D-200

Alicates de boca semirredonda, punta curva 60°



ergo®



4833

	€		
130 mm	47,00	3	4833

Alicate con punta de aguja, punta curva 45°



C3745

	€		
141 mm	39,16	10	C3745
141 mm	38,51	10	C3745IP

IP: Embalaje industrial

Alicate con punta de aguja, punta curva 90°



C3790

	€		
125 mm	39,52	10	C3790
125 mm	38,51	10	C3790IP

IP: Embalaje industrial



Alicate de manipulación punta curvada 60°



2656R

↔ L ↔	€	📦	🐟
129 mm	81,35	1	2656 R



Alicates de boca semiredonda, curvados



2477G-200

🐟	🐟	🐟	€	📦	🐟
3.0 mm	1.5 mm	1 mm	17,88	5	2477G-160
3.0 mm	1.5 mm	1 mm	22,66	5	2477 G-200

Alicate de boca semicircular extra largo



158-NB

↔ L ↔	€	📦	🐟
270 mm	38,64	12	158-NB

Alicates de boca plana



2420G

↔ L ↔	€	📦	🐟
125 mm	26,36	5	2420 G-125
125 mm	21,34	5	2420G-125IP

IP: Embalaje industrial

Alicates de boca plana



2421G

↔ L ↔	€	📦	🐟
140 mm	27,86	5	2421 G-140
160 mm	30,62	5	2421 G-160
180 mm	36,78	5	2421 G-180
140 mm	27,16	5	2421 G-140IP
160 mm	29,90	5	2421 G-160 IP
180 mm	36,08	5	2421 G-180 IP

IP: Embalaje industrial

Alicates de boca plana - cromados



2421GC

↔ L ↔	€	📦	🐟
140 mm	22,78	5	2421GC-140IP
160 mm	25,04	5	2421GC-160IP
180 mm	25,39	5	2421GC-180IP

IP: Embalaje industrial

Alicates de boca plana, mangos recubiertos de PVC



2421D

Length (mm)	Price (€)	Quantity	Material
140 mm	22,81	5	2421 D-140IP
160 mm	25,14	5	2421 D-160IP
180 mm	29,99	5	2421 D-180IP

IP: Embalaje industrial

Alicate de boca plana



C3430

Length (mm)	Price (€)	Quantity	Material
129 mm	36,60	10	C3430
129 mm	36,19	10	C3430IP

IP: Embalaje industrial

Alicate para conectores



7835G

Material	Size (mm)	Price (€)	Quantity	Material
Cu	3.0 mm	44,50	5	7835 G-160
Fe	1.8 mm			
Fe+	1.6 mm			

Alicate de boca plana



2646MF

Length (mm)	Price (€)	Quantity	Material
120 mm	70,59	1	2646 MF

Alicates de boca plana



4430

Length (mm)	Price (€)	Quantity	Material
135 mm	41,08	3	4430

Alicates de boca plana



2471G

Length (mm)	Price (€)	Quantity	Material
165 mm	16,75	5	2471 G-160



Alicate para tuercas



2979D

	€		
180 mm	41,08	5	2979 D-180

Alicates de boca redonda



4530

	€		
135 mm	43,35	3	4530

Alicate de boca redonda



2521G

	€		
140 mm	27,65	5	2521 G-140
160 mm	30,47	5	2521G-160
140 mm	28,02	5	2521G-140IP
160 mm	28,59	5	2521 G-160 IP

IP: Embalaje industrial

Alicate de boca redonda



C3530

	€		
127 mm	36,95	10	C3530
127 mm	36,19	10	C3530IP

IP: Embalaje industrial

Alicate de boca redonda, mangos recubiertos de PVC



2521D

	€		
140 mm	19,98	5	2521D-140IP
160 mm	23,54	5	2521D-160IP

IP: Embalaje industrial

Alicate de boca semirredonda



2646MS

	€		
120 mm	78,26	1	2646 MS

TENACILLAS ARTICULADAS

Tenacillas articuladas ajustables ERGO™



ergo®



8223 - 8226



← L →	€		
210 mm	47,00	4	8223
250 mm	55,34	4	8224
315 mm	75,65	4	8225
400 mm	84,27	1	8226
210 mm	46,33	4	8223 IP
250 mm	54,67	4	8224 IP
315 mm	74,98	4	8225 IP

IP: Embalaje industrial

Tenacillas articuladas ajustables ERGO™



ergo®



8224/8225C



← L →	€		
250 mm	34,93	4	8224CIP
315 mm	46,61	4	8225CIP

Tenacilla articulada ajustable de gran apertura



ergo®



8231



max	← L →	€		
51 mm	225 mm	49,64	4	8231
51 mm	225 mm	48,97	4	8231 IP

IP: Embalaje industrial

Tenacilla articulada de ajuste rápido



7223-7225

max	← L →	€		
45 mm	200 mm	33,32	4	7223
63 mm	250 mm	34,43	4	7224
70 mm	300 mm	43,35	8	7225
45 mm	200 mm	31,59	8	7223IP
63 mm	250 mm	32,79	4	7224IP
70 mm	300 mm	41,72	4	7225IP

IP: Embalaje industrial

Tenacilla articulada de ajuste rápido con mangos de pvc



7223D 7225D

	← L →	€		
16	200 mm	32,19	8	7223D
25	300 mm	42,33	4	7225D
16	200 mm	31,00	8	7223D IP
25	300 mm	41,37	4	7225D IP

IP: Embalaje industrial

Tenacilla de apertura múltiple de canal



6224

	← L →	€		
11	250 mm	32,19	4	6224

ISO 8976



Tenacilla articulada ajustable con mangos de pvc



6221D-6225D

		€		
6	125 mm	20,86	10	6221D
8	150 mm	22,17	10	6222D
10	200 mm	22,66	8	6223D
11	250 mm	20,27	5	6224D
13	300 mm	35,79	10	6225D
6	125 mm	20,50	10	6221D IP
8	150 mm	21,78	10	6222D IP
10	200 mm	22,30	8	6223D IP
11	250 mm	19,88	5	6224D IP
13	300 mm	35,38	5	6225D IP

IP: Embalaje industrial

Tenacilla de ajuste rápido



2971G

		€		
35 mm	250 mm	15,53	5	2971G-250

Tenacilla de ojal



221 D - 225 D

	€		
117 mm	14,72	5	221 D
150 mm	15,22	5	222 D
192 mm	16,22	5	223 D
240 mm	18,29	5	224 D
305 mm	27,98	5	225 D

Tenacilla articulada



5223 - 5226 DC

		€		
105 mm	400 mm	54,75	1	5226 DC

Alicate para terminales



2650

		€		
65 mm	235 mm	72,70	1	2650
	235 mm	6,47	1	2650 B

Juego de 3 tenacillas articuladas



622-3P

			€		
110 x 50 x 390 mm	3	1260 g	91,68	1	622-3P

6223D, 6224D, 6225D



Juego de 3 tenacillas articuladas



7224-622XD-3P

			€		
75 x 50 x 260 mm	3	813 g	88,03	1	7224-622XD-3P

			€		
40-100 mm	2.2 mm	210 mm	29,20	3	2890-210
85-165 mm	3.1 mm	300 mm	43,62	1	2890-300

Alicates para arandelas interiores



2461

			€		
8-25 mm	1.0-2.0 mm	140 mm	71,36	1	2461 C8
19-60 mm	2.0-2.5 mm	180 mm	73,95	1	2461 C19
40-100 mm	2.5-3.5 mm	255 mm	85,06	1	2461 C40

ALICATES PARA ARANDELAS

Alicates para arandelas interiores



2800

			€		
8-13 mm	0.8 mm	140 mm	19,69	3	2800-140
12-25 mm	1.2 mm	150 mm	19,69	3	2800-150
19-60 mm	1.7 mm	180 mm	22,48	3	2800-180
40-100 mm	2.2 mm	225 mm	28,30	3	2800-225
85-165 mm	3.1 mm	310 mm	38,80	1	2800-300

Alicates para arandelas interiores boca curvada 90°



2890

			€		
8-15 mm	0.8 mm	127 mm	17,07	3	2890-125
12-25 mm	1.2 mm	127 mm	20,00	3	2890-140
19-60 mm	1.7 mm	180 mm	23,20	3	2890-180

Alicates para arandelas interiores



2463

			€		
8-25 mm	1.0-2.0 mm	130 mm	62,29	1	2463 D8
19-60 mm	2.0-2.5 mm	170 mm	75,85	1	2463 D19
40-100 mm	2.5-3.5 mm	210 mm	87,19	1	2463 D40



Alicates para arandelas exteriores



2900

Ø	+	L	€	📦	🐟
3-10 mm	0.8 mm	140 mm	21,00	3	2900-140
10-25 mm	1.2 mm	150 mm	21,00	3	2900-150
19-60 mm	1.7 mm	180 mm	22,92	3	2900-180
40-100 mm	2.2 mm	215 mm	28,30	3	2900-215
85-165 mm	3.1 mm	300 mm	44,22	1	2900-300

Alicates para arandelas exteriores bocas curvadas 90°



2990

Ø	+	L	€	📦	🐟
3-10 mm	0.8 mm	12 mm	21,51	3	2990-125
10-25 mm	1.2 mm	127 mm	21,51	3	2990-140
19-60 mm	1.7 mm	180 mm	24,17	3	2990-180
40-100 mm	2.2 mm	200 mm	29,20	3	2990-200
85-165 mm	3.1 mm	300 mm	43,05	1	2990-300

Alicates para arandelas exteriores



2464

Ø	+	L	€	📦	🐟
3-10 mm	1.0-1.5 mm	120 mm	77,10	1	2464 A3
10-25 mm	1.5-2.0 mm	120 mm	77,10	1	2464 A10
19-60 mm	2.0-2.5 mm	180 mm	83,87	1	2464 A19
40-100 mm	2.5-3.0 mm	210 mm	92,02	1	2464 A40

Alicates para arandelas exteriores



2466

Ø	+	L	€	📦	🐟
3-10 mm	1.0-1.5 mm	130 mm	78,60	1	2466 B3
10-25 mm	1.5-2.0 mm	130 mm	78,60	1	2466 B10
19-60 mm	2.0-2.5 mm	165 mm	85,90	1	2466 B19
40-100 mm	2.5-3.0 mm	190 mm	96,73	1	2466 B40

Alicate para arandelas interiores y exteriores



2928

Ø	Ø	L	€	📦	🐟
7-26 mm	3-26 mm	160 mm	57,14	1	2928-160
10-51 mm	7-51 mm	200 mm	80,66	1	2928-200
46-102 mm	38-102 mm	250 mm	115,36	1	2928-250

Puntas de repuesto para series 2928



2928-1 - 4

🐟	€	📦	🐟
2928-160	15,38	1	2928-1
2928-200	15,38	1	2928-2
2928-250	15,38	1	2928-3
2928-250	15,38	1	2928-4

Alicates para arandelas exteriores



2460

	€		
175 mm	52,85	1	2460

Alicates especiales para arandelas ciegas



2465D

	€		
200 mm	58,81	1	2465D-200

Juego 4 alicates para arandelas



28-29/S4

	€		
740 g	107,34	1	28-29/S4

2900-180		
2800-180		
2990-180		
2890-180		

Juego de alicates para arandelas interiores y exteriores



9938

	€		
1640 g	216,20	1	9938

2928-160, 2928-200, 2928-250		
------------------------------	--	--

PELACABLES Y HERRAMIENTAS PARA DESMONTAJE

Pelacables



2223G

		€		
0.5-5 mm	165 mm	28,61	5	2223 G-150



Pelacables



2223D

		€		
0,5-5 mm	165 mm	29,12	5	2223 D-150

Pelacables automático



3418 A

			€		
20-10 AWG	0,5-6 mm ²	3 mm	35,19	1	3418 A

Pelacables automático



3416 B

		€		
0,02-10 mm ²	34-8 AWG	152,71	10	3416 B
		59,49	10	3416 B SH

SH: Hoja de repuesto para pelacables

Pelacables giratorio



3520 B

		€		
4,5-40 mm	167 mm	103,61	10	3520 B
		29,69	10	3520 B SH

SH: Hoja de repuesto para pelacables

Pelacables automático



3416 A

		€		
0,2-6 mm ²	24-10 AWG	44,09	6	3416 A
		16,68	1	3416 A SH

SH: Hoja de repuesto para pelacables

Pelacables



3520 A

	€		
0,5-6 mm ²	33,74	1	3520 A
	5,67	1	3520 A SH

3520 A SH: Hoja de repuesto

Pelacables giratorio



3518 A

		€		
4-28 mm	185 mm	24,33	1	3518 A
		5,70	1	3518 A SH

SH: Hoja de repuesto para pelacables

Pelacables universal con cuchilla retráctil



3518 B

		€		
0,5-6 mm ²	125 mm	44,35	1	3518 B

Pelacables para cables planos y redondos



3517 A

		€		
6-13 mm	120 mm	34,89	1	3517 A

Herramienta de pelado para cables de datos de PVC



3717 A

			€		
115 mm	4.5-10 mm mm	28 g	27,56	1	3717 A

Pelacables Coaxial



3417 A

		€		
4.8-7.5 mm	110 mm	29,15	12	3417 A

Pelacables de precisión



3619 A

		€		
2,5-11 mm	91 mm	52,34	10	3619 A
		14,19	10	3619 A SH

SH: Hoja de repuesto para pelacables



Herramienta de pelado de precisión



3719 A

			€		
0,12-0,8 mm	36-20 AWG	112 mm	39,37	12	3719 A

Herramienta de inserción para bloques LSA



3718 A

			€		
185 mm	0,7-2,6 mm	60 g	51,18	12	3718 A

Pelacables autoajustable standar



3419 B

	€		
0.25-6.00 mm	119,31	1	3419 B
	36,18	1	3419 B SH

3419EB: Cuchilla de repuesto

ALICATES PARA TERMINALES

Alicates para terminales aislados



CR B 01

	AWG		€		
0.50-6.00 mm ²	20-10	220 mm	27,62	60	CR B 01

Alicates para terminales NO aislados



CR B 02

	AWG		€		
1.50-6.00 mm ²	14-10	220 mm	26,57	60	CR B 02

Alicates para terminales no aislados tipo faston



CR B 03

	AWG		€		
1.50-6.00 mm ²	14-10	220 mm	27,04	60	CR B 03

Alicates para terminales tubulares



CR B 05

	AWG		€		
0.5-2.5 mm ²	20-14	140 mm	53,76	2	CR B 05

Alicate de carraca desembagable para terminales aislados



CR W 01

	AWG		€		
0.5-6.0 mm ²	20-10	225 mm	155,55	1	CR W 01

Alicates para terminales tubulares



CR B 06

	AWG		€		
0.5-16 mm ²	20-6	220 mm	107,50	2	CR B 06

Alicate de carraca desembagable para terminales NO aislados



CR W 02

	AWG		€		
20-10 mm ²	20-10	225 mm	129,86	1	CR W 02

Alicates de carraca para terminales para conectores aislados, perfil ovalado



CR OV 01

	AWG		€		
0.5-6.0 mm ²	20-10	256 mm	157,47	1	CR OV 01

Alicate de carraca desembagable para terminales NO aislados de barril abierto



CR W 03

	AWG		€		
0.5-6.0 mm ²	20-10	225 mm	129,86	1	CR W 03



Alicates de carraca desmontable para terminales de cable coaxial BNC-TNC



CR W 04

		€	
RG 58-59-62 mm ²	225 mm	135,78	1 CR W 04

Alicates autoajustables para terminales, perfil cuadrado



CR SA S01

	AWG		€	
0.14-10 mm ²	26-8	176 mm	212,58	1 CR SA S01

Alicates de carraca desmontable para terminales tubulares



CR W 05

AWG		€	
0.5-4.0	225 mm	137,88	1 CR W 05

Alicates autoajustables para terminales, perfil hexagonal



CR SA H01

	AWG		€	
0.14-10 mm ²	26-8	176 mm	219,33	1 CR SA H01
0.14-16 mm ²	26-6	176 mm	240,45	1 CR SA H16

Alicates de carraca desmontable para terminales tubulares



CR W 06

AWG		€	
6-16	225 mm	145,73	1 CR W 06

Alicates autoajustables para terminales, perfil trapecoidal



CR SA T01

	AWG		€	
0.14-10 mm ²	26-8	180 mm	208,08	1 CR SA T01

Prensa terminales, terminales NO aislados



CR L 01

			€		
10-120 mm ²	10-95 mm ²	600 mm	398,68	1	CR L 01

Matriz ajustable 9 secciones de compresión

Prensa terminales "heavy duty" para terminales no aislados



CR L 02

		€		
6-50 mm ²	360 mm	294,47	1	CR L 02

Capacidad mm2 6-10-16-25-35-50 No utilizar bajo tensión eléctrica

Prensa terminales, terminales no aislados prensado huella hexagonal



CR L 03

		€		
25-150 mm ²	650 mm	448,52	1	CR L 03

Capacidad mm2 25-35-50-70-95-120-150 No utilizar bajo tensión eléctrica

JUEGOS DE ALICATES

Juego de alicates para mecánica de precisión



9733

		€		
30 x 215 x 215 mm	8	386,68	1	9733

4130, 4131	
4239	
4830	
4530	
4231	
4430	
4833	

Juego de alicates de precisión



C3901/3

	€		
3	123,40	1	C3901/3

C3140IP	
C3640IP	
C3830IP	



Juego de alicates de precisión



C3902/3

	€		
3	113,00	1	C3902/3

C3330R	
C3840	
C3745	

Juego de alicates compactos y destornilladores, 8 piezas



C3903/2-6

	€		
8	113,62	1	C3903/2-6

C3330R	
C3840	
700-1.5-50, 700-2-50, 700-2.5-50, 700-3-50	
701-0-50, 701-1-75	

Juego de llave ajustable y tenacilla



9031-8224

		€		
2	693 g	86,43	3	9031-8224

BAHCO

9031	
8224	

Pack 2 herramientas para fontanero



9873

		€		
25 x 190 x 280 mm	2	54,35	1	9873

9072 P	
8224	

Juego 3 herramientas



9853

		€		
25 x 252 x 292 mm	3	80,54	1	9853

9071	
2101G-160	
8224	

Juego de 4 alicates



ergo®



9897

		€		
4	1030 g	136,33	1	9897

		€		
4 mm	300 mm	48,04	1	2951-300

Mordaza grip, bocas curvas sin cortante



2953

	€		
140 mm	16,93	1	2953-140
190 mm	22,51	1	2953-200
235 mm	25,69	1	2953-250
300 mm	44,40	1	2953-300

8224



2628 G-180

2101G-160

2430 G-160

Juego de alicates universales ERGO™ (3 piezas)



ergo®



9897G/3

			€		
3	50 x 180 x 400 mm	788 g	81,99	1	9897G/3

Mordaza con bocas rectas



2958

	€		
135 mm	17,97	1	2958-140
190 mm	24,78	1	2958-200
235 mm	28,54	1	2958-250

Mordaza grip bocas recta y convexa



2968

	€		
205 mm	24,78	1	2968-190
235 mm	28,54	1	2968-235

MORDAZAS DE PRESION

Mordaza grip bocas curvas, con cortante



2951

		€		
1.2 mm	140 mm	18,13	1	2951-140
2 mm	190 mm	24,78	1	2951-180
3 mm	235 mm	28,54	1	2951-250



Mordaza grip Omnium



2957

	€		
250 mm	27,03	1	2957-250

Mordazas grip con bocas paralelas



2955

	€		
235 mm	32,47	1	2955-250

Mordaza grip de punta larga y mordaza fina



2952

	€		
155 mm	21,58	1	2952-165
230 mm	30,82	1	2952-235

Grips de cadena con Acabado en Níquel



2999

	€		
230 mm	48,62	1	2999-250
500 mm	14,31	1	2999-SHN

2999-SH: Cadena de repuesto

Mordazas grip para planchas de metal con Acabado en Níquel



2967

	€		
180 mm	39,27	1	2967-180

Cortatubo de cadena



2998

	€		
240 mm	91,97	1	2998-250
330 mm	53,65	1	2998-SHN

2998-SH: Cadena de repuesto

Mordaza para mesa



2960

	€		
280 mm	54,25	1	2960-280

Grip con dos bocas autoadaptables



2950

	€		
235 mm	33,98	1	2950-250

Mordaza grip con sujeción C



2963

	€		
283 mm	37,91	1	2963-280
458 mm	62,22	1	2963-450
580 mm	74,83	1	2963-630

Mordaza de acero delgada, almohadillas giratorias



2956

	€		
282 mm	44,71	1	2956-290

Mordaza grip con sujeción C paralela



2964

	€		
175 mm	31,26	1	2964-160
280 mm	41,22	1	2964-280
436 mm	69,61	1	2964-450
625 mm	81,53	1	2964-600

Mordazas grip cpm sujeción C



2962

	€		
290 mm	56,87	1	2962-8-150
290 mm	73,09	1	2962-8-230
290 mm	79,28	1	2962-8-300



Mordaza grip para soldadura tipo U



2965

← L →	€		
228 mm	32,62	1	2965-200
290 mm	43,20	1	2965-280

Grip universal, mordazas largas, 4 posiciones



2997

← L →	€		
255 mm	74,89	5	2997-300

Mordaza grip para tubos



2966

← L →	€		
290 mm	44,24	1	2966-280

Grip universal, mordazas cortas, 4 posiciones



2997-250

← L →	€		
235 mm	67,97	1	2997-250

Repuestos para mordazas



2951-S

	← L →		€		
	43 mm	15 g	3,62	1	2951-S05
	46 mm	25 g	3,62	1	2951-S07
	62 mm	50 g	3,62	1	2951-S10
	87 mm	70 g	3,62	1	2951-S12

Tenazas de ajuste rápido



2949

← L →	€		
193 mm	62,31	1	2949-190IP
196 mm	66,10	1	2949-200IP
240 mm	69,28	1	2949-240IP
240 mm	86,07	1	2949-250IP

Husillo de respuesta: 2949-xxxSH IP: Embalaje industrial

Tornillo de recambio para tornillos de banco



2949-L

		€		
2949-190IP	75 mm	5,72	1	2949-L075
2949-200IP, 2949-240IP	120 mm	5,96	1	2949-L120
2949-250IP	200 mm	7,33	1	2949-L200

REMACHADORAS

Remachadora con cabeza giratoria



2681

	€		
285 mm	40,48	12	2681

Remachadora manual



1467-250

	€		
255 mm	61,59	1	1467-250

Alicates de muescas



2690

	€		
200 mm	58,30	10	2690

Remachadora de brazos largos



1467-520

	€		
530 mm	199,94	1	1467-520

Remachadora extensible, mm



1467-320-850

	€		
850 mm	258,79	1	1467-320-850



Respuestos para remachadora 1467



1467

g	€		
10 g	19,17	1	1467-LJ
10 g	15,56	1	1467-SJ

Juego de repuestos para 2681



2681-1

g	€		
15 g	3,46	1	2681-1

ALICATES ESPECIALES

Herramienta tensora para abrazaderas de Nylon, tipo pistola



790450A

∅	€		
<2.2x5 mm	65,98	1	790450A

Tensa hasta 5mm de ancho y grosor 1,6mm

Herramienta tensora para abrazaderas de Nylon (Bridas)



790455A

∅	€		
<9.5x2.3 mm	56,03	1	790455A

Tensa hasta 9,5mm de ancho y grosor 2,3mm

Alicate trenzador



2855

L	€		
236 mm	154,37	1	2855
287 mm	195,42	1	2855 D

Alicate trenzador de alambre



2856

L	€		
203 mm	314,51	1	2856-8
268 mm	314,51	1	2856-10



Llaves para tubos y herramientas para fontanería



LLAVES PARA TUBOS

Llave para tubo de ajuste rápido



ergo



1610/1620

L	max	€		
320 mm	1 in	78,70	1	1610
430 mm	1 1/2 in	107,06	1	1620

10 veces más rápido que el modelo estándar

Llave para tubo modelo sueco, 90°



ergo



1410/1420

L	max	€		
320 mm	1 in	77,09	1	1410
430 mm	1 1/2 in	103,72	1	1420

Llave para tubo modelo sueco 90°
ERGO™ con cómodo mango ERGO™



ergo



1410D/1420D

L	max	€		
320 mm	1 in	85,88	1	1410D
430 mm	1 1/2 in	115,50	1	1420D

Llave para tubo modelo sueco, 90°



140-147

L	max	€		
210 mm	3/4 in	54,84	1	140
320 mm	1 in	61,68	1	141
426 mm	1 1/2 in	82,96	1	142
557 mm	2 1/2 in	135,48	1	143
722 mm	3 1/2 in	225,71	1	144
1060 mm	5 in	434,96	1	147

Llave de tubo de esquina, 45°



442 B-444 B

L	max	€		
320 mm	1 in	67,87	1	442 B
430 mm	2 in	80,23	1	443 B
545 mm	2 1/2 in	107,96	1	444 B

Llave para tubo combinada modelo sueco,
45°



341-344

L	max	€		
230 mm	1/2 in	52,86	1	341
330 mm	1 in	59,48	1	342
420 mm	1 1/2 in	80,00	1	343
530 mm	2 in	119,73	1	344

Tuerca de repuesto para llaves de tubo de
ajuste rápido



1610-nut/1620-nut

Ø	g	€		
11 mm	34 g	12,49	1	1610-NUT
11.5 mm	48 g	14,61	1	1620-NUT

Llave para tubo modelo sueco, 90°



DOW175

L	max	€		
310 mm	1 in	39,56	1	DOW 175-1
420 mm	1 1/2 in	54,29	1	DOW 175-11/2
560 mm	2 in	85,12	1	DOW 175-2
630 mm	3 in	141,82	1	DOW 175-3

Llave de tubo combinada modelo sueco,
45°



DOW177

L	max	€		
325 mm	1 in	49,10	1	DOW 177-1/2-1
425 mm	1 1/2 in	62,39	1	DOW 177-11/2
534 mm	2 in	93,22	1	DOW 177-2

Llave para tubo de esquina modelo sueco, 45°



DOW176

L	max	€		
330 mm	1 in	51,47	1	DOW 176-1
415 mm	1 1/2 in	66,16	1	DOW 176-11/2
530 mm	2 in	91,07	1	DOW 176-2

Mordaza fija de repuesto para llaves de pipa de aluminio



8100F

	g	€		
380-18	90 g	17,84	1	8100F0180
380-24	180 g	20,75	1	8100F0240

Mordaza de repuesto para llaves Stillson



8060B

	g	€		
361-8	80 g	13,05	1	8060B0080
361-10	200 g	18,12	1	8060B0100
361-12	270 g	20,01	1	8060B0120
361-14	330 g	20,15	1	8060B0140
361-18	520 g	28,42	1	8060B0180
361-24	970 g	48,42	1	8060B0240
361-36	1630 g	71,05	1	8060B0360

Llave Stillson de aluminio



380

L	max	€		
253 mm	1.1/2 in	45,14	1	380-10
320 mm	2 in	60,00	1	380-14
455 mm	2.1/2 in	85,71	1	380-18
607 mm	3 in	142,80	1	380-24
910 mm	4 in	276,19	1	380-36
1210 mm	6 in	406,67	1	380-48

Tornillo de repuesto para llaves de pipa de aluminio



8100T

	g	€		
380-10	30 g	6,56	1	8100T0100
380-14	45 g	7,84	1	8100T0140
380-18	70 g	10,53	1	8100T0180
380-24	110 g	14,67	1	8100T0240
380-36	220 g	25,98	1	8100T0360
380-48	310 g	17,13	1	8100T0480

Tuerca de repuesto para llaves Stillson



8060T

	g	€		
361-8	20 g	9,80	1	8060T0080
361-10	20 g	9,21	1	8060T0100
361-14	40 g	9,50	1	8060T0140
361-18	70 g	9,94	1	8060T0180
361-24	90 g	15,81	1	8060T0240
361-36	250 g	24,50	1	8060T0360

Mordaza de repuesto para llaves de pipa de aluminio



8100B

	g	€		
380-14	430 g	30,74	1	8100B0140
380-18	680 g	40,80	1	8100B0180
380-24	1000 g	54,23	1	8100B0240
380-36	1810 g	100,78	1	8100B0360

Llave Stillson para tubos



361

L	max	€		
185 mm	1 in	29,83	1	361-8
230 mm	1.1/2 in	33,17	1	361-10
265 mm	1.3/4 in	38,69	1	361-12
315 mm	2 in	41,48	1	361-14
450 mm	2.1/2 in	58,04	1	361-18
535 mm	3 in	96,46	1	361-24
900 mm	4 in	185,69	4	361-36

Llaves para tubo de cadena para trabajos pesados



372

L	€		
1.1 in	113,33	1	372-1.1/2
2.1 in	209,68	1	372-2.1/2
4 in	267,31	1	372-4
6 in	459,27	1	372-6
8 in	621,59	1	372-8
12 in	1.069,31	1	372-12



Cadena de repuesto para llaves con cadena



3074

L		€		
340 mm	372-1.1/2	34,16	1	307401B
475 mm	372-2.1/2	51,07	1	307411B
560 mm	372-4	82,35	1	307421B
830 mm	372-6	136,83	1	307431B
1000 mm	372-8	186,59	1	307441
1400 mm	372-12	273,66	1	307451

Llave para tuercas de lavabo



363

L	€		
280 mm	47,03	1	363-32

Cortatubos 35 mm



402-35

Ø	€		
3-35 mm	55,83	6	402-35

Llave de cadena para tubo



370

L	€		
300 mm	47,03	1	370-4

Cortatubos 16 mm



401-16

Ø	€		
3-16 mm	31,08	12	401-16

Cortatubos 76 mm



402-76

Ø	€		
12-76 mm	114,20	6	402-76

Llave de cinta



375

L	€		
300 mm	47,03	50	375-8

Cortatubos 28 mm



401-28

Ø	€		
3-28 mm	31,08	12	401-28

Cortatubos automático



306-

Ø	€		
10 mm	31,36	1	306-10
12 mm	33,14	1	306-12
15 mm	34,89	12	306-15
22 mm	38,37	12	306-22

Cortatubos



301-16

		€		
3-16 mm	72 mm	27,36	12	301-16

Cortatubos



302-76

	€		
	6,12	1	302-76-95

Juego de discos y pon de repuesto para llaves de pipa 301/302, 4 piezas



302-95-SET

	€		
30 g	24,87	1	302-95-SET

Cortatubos



301-22

	€		
3-28 mm	26,12	12	301-22

Corta tubos con sistema de ajuste rápido



302-76N

		€		
12-76 mm	318 mm	94,54	6	302-76N

Recambio de disco de corte



306-15-95

	€		
10 g	12,06	1	306-15-95

Cortatubos



302-35

	€		
3-35 mm	41,52	6	302-35

Discos de corte de repuesto para cortatubos de la serie 301/302 y 401/402



302/402-15-95

		€		
301-16,301-22, 302-35,302-75N	5 g	6,36	100	302-15-95
401-16,401-28, 402-35,402-75	5 g	9,45	1	402-15-95

Arandelas/pin para juego 401/402



402-95-SET

	€		
30 g	36,79	1	402-95-SET



Cortador para tubos de plástico



311-32

	€		
32 mm	21,63	6	311-32

Cortatubos para multicapa



412-26-MULTI

	€		
26 mm	85,57	5	412-26-MULTI

Hojas de repuesto para 412-26-MULTI



412-26-MULTI-95

		€		
1	10 g	20,32	150	412-26-MULTI-95

Cortatubos de plástico



411

	€		
26 mm	45,63	4	411-26
35 mm	59,69	4	411-35
42 mm	78,27	6	411-42
63 mm	115,15	5	411-63

Hojas de repuesto para tijeras de plástico



411-95

		€		
1	39 g	16,94	50	411-26-95
1	37 g	26,56	50	411-35-95
1	41 g	31,40	50	411-42-95
1	48 g	59,39	30	411-63-95

Curva-tubos



1084

		€		
250 mm	6,8 10 mm	87,04	5	1084

Cortatubos para PEX



412-28-PEX

	€		
28 mm	58,51	5	412-28-PEX

Hojas de repuesto para 412-28-PEX



412-28-PEX-95

		€		
1	35 g	20,22	30	412-28-PEX-95

Dobladora de tubos



500

	€		
12 mm	120,53	1	500-12
14 mm	129,22	1	500-14
15 mm	133,23	1	500-15
16 mm	139,57	1	500-16
18 mm	164,33	1	500-18
22 mm	188,31	1	500-22

Abocinador en métrica



4480MM

		€		
45°	4, 6, 8, 10, 12, 14, 16, 18 mm	59,70	1	4480MM

Abocinador en pulgadas



4480IM

		€		
45°	5/8, 3/16, 1/4, 5/16, 3/8, 7/16, 1/2, 3/4 in	59,70	1	4480IM

Juego de abocinador y corta-tubos



4480/

	€		
45 x 140 x 330 mm	155,68	1	4480/2-ZD

HERRAMIENTAS DE REBABADO

Rebabador



316-1

	€		
143 mm	13,38	12	316-1

Rebabador



316-2

	€		
150 mm	20,05	12	316-2

Rebabador: recambio de 316-2



316-2-95

	€		
3 g	10,56	1	316-2-95

Rebabador interno/externo



318-38/318-54

	€		
8-38 mm	84,17	1	318-38
10-54 mm	134,86	1	318-54

Rebabador interno/externo



317-40

	€		
3-40 mm	13,48	12	317-40





BAHCO



Herramientas neumáticas



PISTOLAS DE IMPACTO NEUMÁTICAS

Llave de impacto mini con cuadradillo de 3/8"



BP704

BAR €
 6.3 bar 1500 min **212,33** 1 BP704

Llave impacto 3/8" composite



BPC816

BAR €
 12.000 min 6,3 bar **301,40** 10 BPC816

Diam. manguera 10mm. Par máx. 583Nm

Llave de impacto acodada 1/2"



BP814A

BAR €
 7000 min 6.2 bar **496,77** 10 BP814A

Llave de impacto neumática compacta 1/2"



BP814

BAR €
 10,000 min 6.3 bar **254,92** 10 BP814

Diam manguera 10mm Par máx 410Nm

Llave de impacto neumática 1/2"



BP815

BAR €
 7,000 min 6.3 bar **254,92** 1 BP815

Diam manguera 10mm Par máx 825Nm

Juego llave BP815 con 11 vasos, mm



BP815K1

BAR €
 7,000 min 6.3 bar **372,58** 1 BP815K1

BP815

K7800M-10, K7800M-11, K7800M-12, K7800M-13, K7800M-14, K7800M-15, K7800M-17, K7800M-19, K7800M-22, K7800M-24, K7800M-21

PM5142

Juego llave BP815 con soporte y 3 vasos para ruedas



BP815K2

BAR €
 7,000 min 6.3 bar **320,29** 1 BP815K2

Mini llave de impacto neumática 1/2"



BPC813

BAR €
 10000 min 6,3 bar **254,92** 10 BPC813

Diam. manguera 10mm. Par máx. 678Nm

Juego mini llave de impacto con vasos ultra cortos



BPC813K1

1/2 in 65 x 162 x 215 mm **344,15** 1 BPC813K1

BPC813

K7800M-13, K7800M-14, K7800M-16, K7800M-17, K7800M-19, K7800M-21, K7800M-22, K7800M-24

Llave de impacto neumática compacta 1/2"



BPC814

	BAR	€		
12000 min	6,3 bar	294,15	10	BPC814

Diam. manguera 10mm. Par máx. 678Nm

Llave de impacto neumática 1/2" alta potencia



BPC815

	BAR	€		
8000 min	6,3 bar	307,21	1	BPC815

Diam. manguera 10mm. Par máx. 1.112Nm

Juego llave BPC815 con 11 vasos, mm



BPC815K1

		€	
1/2 in	90 x 230 x 390 mm	592,19	1 BPC815K1

BPC815		
K7801M-10, K7801M-11, K7801M-12, K7801M-13, K7801M-14, K7801M-15, K7801M-17, K7801M-19, K7801M-21, K7801M-22, K7801M-24		

Juego llave BPC815 con 5 vasos, mm



BPC815K2

		€	
1/2 in	90 x 230 x 320 mm	507,40	1 BPC815K2

BPC815		
K7801M-19, K7801M-22, K7801M-24, K7801M-17, K7801M-13		

Juego llave BPC815 con 5 vasos, pulgadas



BPC815K3

		€	
1/2 in	90 x 230 x 320 mm	523,78	1 BPC815K3

BPC815		
K7801Z-1/2, K7801Z-5/8, K7801Z-3/4, K7801Z-7/8, K7801Z-15/16		

Juego llave BPC815 con 5 vasos para ruedas



BPC815K4

		€	
1/2 in	90 x 230 x 320 mm	548,31	1 BPC815K4

BPC815	
BWSS12P5	

Juego llave BPC815 con 2 vasos para ruedas



BPC815K6

		€	
1/2 in	90 x 230 x 320 mm	483,01	1 BPC815K6

BPC815		
BWSS12P319, BWSS12P317		

Llave de impacto de 3/4"



BP817

	BAR	€		
4,500 min	6.3 bar	620,95	1	BP817

Diam manguera 10mm Par máx 1800Nm

Llave de impacto de composite 3/4"



BPC817

	BAR	€		
5000 min	6,2 bar	699,40	4	BPC817



Juego llave BPC817 con 4 vasos, mm



BPC817K1

		€		
3/4 in	105 x 295 x 390 mm	1.037,16	1	BPC817K1

BPC817
 K8901M-24, K8901M-27, K8901M-32, K8901M-30

Juego llave BPC817 con 4 vasos, pulgadas



BPC817K2

		€		
3/4 in	105 x 295 x 390 mm	1.019,36	1	BPC817K2

BPC817
 K8901Z-15/16, K8901Z-1, K8901Z-1.1/16, K8901Z-1.1/8

Llave de Impacto de 1"



BP901

		€		
3800 min	6.2 bar	986,99	1	BP901

Diam maguera 13mm Par máx 2.800Nm

Llave de impacto de 1", Yunque largo



BP901L

		€		
3800 min	6.2 bar	1.000,05	1	BP901L

Diam manguera 13mm Par máx 2.800Nm

Llave de impacto 1" ligera



BP905P

		€		
6000 min	6.2 bar	1.300,73	2	BP905P

Llave de impacto 1" ligera , Yunque corto



BP905S

		€		
6000 min	6.2 bar	1.292,89	2	BP905S

Llave de Impacto de 1". Eje largo.



BP905L

		€		
6000 min	6.2 bar	1.305,95	2	BP905L

Funda protectora para llave de impacto



BPM91B

		€		
85 x 80 x 180 mm	162 g	15,32	1	BPM917BOOT

BPM91BS para ser usada con BPM914 y BPM916 BPM91BL para ser usada con BPM915

Juego de silenciadores para llave de impacto



BPM91MK

		€		
30 x 25 x 25 mm	5 g	5,81	1	BPM91MK1
30 x 25 x 50 mm	10 g	5,81	1	BPM91MK2

BPM91MK1 para ser usado con BPM914 y BPM916 BPM91K2 para ser usado con BPM915

CARRACAS NEUMÁTICAS

Mini Carraca de 1/4"



BP700

	BAR	€		
300 min	6.3 bar	204,10	20	BP700

Diam manguera 10mm

Carracas neumáticas stubby 3/8"



BP721

	BAR	€		
350 min	6.3 bar	182,18	1	BP721

Carraca de 3/8"



BP820

	BAR	€		
270 min	6.3 bar	217,66	1	BP820

Diam manguera 10mm

Carraca de 1/2"



BP821

	BAR	€		
150 min	6.3 bar	255,28	1	BP821

Diam manguera 10mm

Carraca neumática con embrague de 1/2"



BPR821

	BAR	€		
600 min	6.3 bar	263,84	1	BPR821

Funda protectora para carraca neumática



BP91B

		€		
35 x 40 x 60 mm	12 g	3,02	1	BP91BL
30 x 30 x 45 mm	6 g	3,02	1	BP91BS

BP91BS para ser usada con BP919 y BP920 BP91L para ser usada con BP921

AMOLADORAS, LIJADORAS Y PULIDORAS NEUMÁTICAS

Mini Amoladora Cabeza Angular 6mm



BP115

	BAR	€		
20,000 min	6.3 bar	202,66	1	BP115

Boquillas de 3 y 6mm incluidas

Mini amoladora de bajas revoluciones



BP117

	BAR	€		
2500 min	6.3 bar	262,71	1	BP117

Diam manguera 10mm

Amolador de bajas revoluciones para neumáticos



BP118

	BAR	€		
2500 min	6.3 bar	239,07	1	BP118

Portamuelas con llave Conexión giratoria



Mini amoladora 6 mm



BP822

	BAR	€		
25,000 min	6.3 bar	165,49	1	BP822

Boquillas de 3 y 6mm incluidas

Disco abrasivo, 2 unidades



BP421M

		€		
53 mm	14 mm	4,56	1	BP421M

Disco abrasivo, 2 unidades



BP424M

		€		
57 mm	19 mm	4,56	1	BP424M

Amoladora 6 mm



BP822E

	BAR	€		
25000 min	6.3 bar	202,66	10	BP822E

Boquillas de 3 y 6mm incluidas

Disco abrasivo, 2 unidades



BP422M

		€		
46 mm	26 mm	4,56	1	BP422M

Disco abrasivo, 2 unidades



BP430M

		€		
55 mm	12 mm	4,56	1	BP430M

Disco abrasivo, 2 unidades



BP420M

		€		
67 mm	25 mm	4,56	1	BP420M

Disco abrasivo, 2 unidades



BP423M

		€		
53 mm	25 mm	4,56	1	BP423M

Disco abrasivo, 2 unidades



BP431M

		€		
54 mm	13 mm	4,56	1	BP431M

BAHCO

Disco abrasivo, 2 unidades



BP432M

		€		
44 mm	15 mm	4,56	1	BP432M

Mini radial reversible 3" - 75 mm



BP110

	BAR	€		
18,000 min	6.3 bar	221,76	1	BP110

Diam manguera 10mm

Manguera de escape



BP117EH

		€		
50 x 100 x 50 mm	1 kg	45,25	1	BP117EH

Disco abrasivo, 2 unidades



BP433M

		€		
43 mm	14 mm	4,56	1	BP433M

Amoladora Disco 5" - 125mm



BP823

	BAR	€		
10,000 min	6.3 bar	420,31	1	BP823

Diam manguera 10mm

Limpiadora de superficies 3.700rpm



BP127

	BAR	€		
3700 min	6.3 bar	394,04	1	BP127

Baja vibración

Disco abrasivo, 2 unidades



BP434M

		€		
45 mm	13 mm	4,56	1	BP434M

Cortadora 4"/102mm de largo alcance



BP111E

	BAR	€		
15000 min	6.3 bar	309,35	12	BP111E

Sistema bloqueo del disco

Limpiador de superficies con 19 varillas y mango tipo pistola



BP127P

	BAR	€		
3800 min	6.3 bar	271,38	1	BP127P



Juego de varillas



BP12718

		€		
BP127, BP127P	3 mm	22,53	1	BP12718

Cepillo goma para pintura base disolvente



BP830ESB

		€		
30 mm	105 mm	27,24	1	BP830ESB

Adaptador para cepillo metálico



BP830SBA

		€		
BP830K	105 mm	23,87	1	BP830SBA

Púas de acero inclinadas



BP830CISB

		€		
BP830K	105 mm	36,70	1	BP830CISB

Cepillo goma para pintura base agua



BP830EWB

		€		
BP830K	105 mm	27,24	1	BP830EWB

Cepillo cerdas metálicas rectas



BP830SSB

		€		
BP830K	105 mm	36,70	1	BP830SSB

Juego de cepillo neumático



BP830K

	BAR	€		
4000 min ⁻¹	6.3 bar	521,40	4	BP830K

Cepillo cerdas metálicas medianas inclinadas

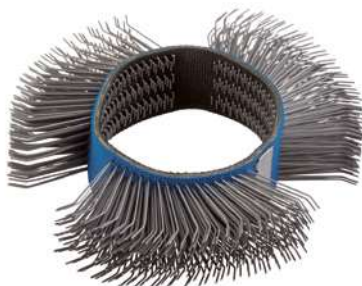

BP830MISB

		€		
BP830K	105 mm	36,70	1	BP830MISB

Cepillo decapado



BP830SW

		€		
BP830K	105 mm	27,24	1	BP830SW

Juego de lijadora mango pistola



BP204K

	BAR	€		
15000 min	6.3 bar	487,88	1	BP204K

BP20425180, BP20410800, BP20410320, BP20425220

BP204

Almohadillas para lijadora



BP204PAD

		€		
77 mm	-	15,10	1	BP204PAD

Lijadora de banda 10 mm



BP212

	BAR	€		
16,000 min	6.3 bar	244,31	1	BP212

Plato para disco lijadora



BP51137

		€		
152 mm	x	40,70	1	BP51137

Lijadora Orbital 5 mm composite



BP601

	BAR	€		
152 mm	6.3 bar	394,04	1	BP601

Almohadilla de Velcro® incluida

Almohadilla de velcro 53 agujeros



BP60102

		€		
BP601	152 mm	55,98	1	BP60102

Lijadora con mango de pistola



BP204

	BAR	€		
15000 min	6.3 bar	270,19	1	BP204

Discos de lija



BP204xyyy

	€		
77 mm	17,25	1	BP20410320
77 mm	9,15	1	BP20410800
77 mm	34,50	1	BP20425180
77 mm	34,50	1	BP20425220

Lijadora de banda 20 mm



BP222

	BAR	€		
16,000 min	6.3 bar	255,20	1	BP222



Lijadora Orbital 2.5 mm



BP610

	BAR	€		
152 mm	6.3 bar	394,04	1	BP610

Almohadilla de Velcro® incluida

Paquete de 25 bandas para lijadora de banda



BPN22201/21201

	€		
10 mm	141,86	1	BPN21201
20 mm	167,09	1	BPN22201

Pulidora vertical de 7"



BP810

	BAR	€		
2500 min	6.3 bar	353,76	1	BP810

Almohadilla de lana 7"



BP80950

		€		
178 mm	15 g	12,43	1	BP80950

Taladro neumático reversible de 1/2"



BPC825

	BAR	€		
800 min	6.3 bar	183,43	1	BPC825

Taladro neumático reversible de 3/8"-2000rpm



BPC823

	BAR	€		
2000 min	6.3 bar	157,04	1	BPC823

TALADRO NEUMÁTICO

Pulidora angular 7"



BP809

	BAR	€		
2500 min	6.3 bar	406,48	1	BP809

Mango de goma

Taladro reversible 13 mm



BP825

	BAR	€		
450 min	6.3 bar	359,70	1	BP825

Diam manguera 10mm Mango soporte incluido

Taladro neumático angular compacto de 3/8"-10 mm



BPA823

	BAR	€		
1400 min	6.3 bar	154,54	1	BPA823

Atornillador neumático de 1/4"



BP826

	BAR	€		
1800 min	6.3 bar	364,77	1	BP826

Rango par 1-10Nm

Atornillador neumático de 1/4"



BP827

	BAR	€		
800 min	6.3 bar	405,09	1	BP827

Rango par 1-12Nm

HERRAMIENTAS DE CORTE

Sierra alternativa compacta con gatillo de seguridad



BP828

	BAR	€		
10000 min	6.3 bar	276,40	1	BP828

Sierra vaivén



BP824

	BAR	€		
10,000 min	6.3 bar	336,69	1	BP824

Sierra alternativa GEAR-DRIVEN con gatillo de seguridad



BPG824

	BAR	€		
7400 min	6.3 bar	314,10	10	BPG824

Despegador de parabrisas



BP233

	BAR	€		
20	6.3 bar	362,53	1	BP233

Cuchillas rectas



BPBG

	€		
15 mm	34,68	1	BPBG3515
25 mm	34,68	1	BPBG3525A
25 mm	38,63	1	BPBG3525B

Cuchilla en forma de coma



BPBK

	€		
30 mm	34,68	1	BPBK30

Rascador



BPBSC

	€		
15 mm	51,04	1	BPBSC156



Cuchilla en forma de "U"



BPBU

L	€		
18 mm	56,74	1	BPBU18
24 mm	56,74	1	BPBU24
36 mm	64,63	1	BPBU36
60 mm	69,36	1	BPBU60
90 mm	84,32	1	BPBU90

Cizalla neumática



BP811

min ⁻¹	BAR	€		
2,600	6.3 bar	136,99	1	BP811

Capacidad corte: 1.6mm aluminio y 1.2mm acero

Cuchilla acodada 13 mm



BPBG5725/9057

L	€		
57 mm	34,68	1	BPBG5725
90 mm	84,32	1	BPBG9057

MARTILLOS, REMACHADORAS Y MARCADORES

Martillo neumático de 3.200 golpes por minuto



BP910

BAR	min ⁻¹	€		
6.3 bar	3200	182,18	5	BP910

Cinzel giratorio plano 10.2 mm



BP909TF

L	€		
170 mm	29,31	1	BP909TF

Cinzel giratorio plano ancho 10.2 mm



BP909TWF

L	€		
170 mm	29,31	1	BP909TWF

Cinzel giratorio cónico 10.2 mm



BP909TTP

L	€		
165 mm	29,31	1	BP909TTP

Cinzel giratorio canto 10.2 mm



BP909TE

L	€		
139 mm	37,56	1	BP909TE

Cinzel giratorio martillo 10.2 mm



BP909TH

L	€		
108 mm	37,56	1	BP909TH

Cinzel giratorio recto 10.2 mm



BP909TSP

	€		
165 mm	29,31	1	BP909TSP

Cinzel no giratorio plano 10.2 mm



BP909NF

	€		
190.5 mm	79,64	1	BP909NF

Cinzel no giratorio canto 10.2 mm



BP909NE

	€		
173 mm	97,68	1	BP909NE

Remachadora neumática con 880 kg de fuerza de tracción



BP277K

	€		
6.3 bar	14	277,66	8 BP277K

Remachadora neumática con 1.600 kg de fuerza de tracción



BP125A

	€		
6.3 bar	19	697,92	6 BP125A

Marcador neumático



BP799

	BAR	€		
13,000 min ⁻¹	6.3 bar	202,53	1	BP799

Punta del Marcador neumático BP799



BP79912

	€		
10 g	42,74	1	BP79912

Pistola aplicadora de cartuchos



BP215A

BAR	€		
3.5-4.8 bar	65,80	10	BP215A

PISTOLAS DE PINTAR

Pistola para pintar HVLP



BPHVLP01

	BAR	€		
0.7 kg	2-2.8 bar	194,78	1	BPHVLP01



Juego de boquillas



BPHVLP

Ø	€		
1.2 mm	22,86	1	BPHVLP0112
1.4 mm	22,86	1	BPHVLP0114
1.7 mm	22,86	1	BPHVLP0117
2.0 mm	22,86	1	BPHVLP0120

HERRAMIENTAS DE SOPLADO Y LIMPIEZA

Pistola sopladora



BP218

BAR	€		
6.3 bar	25,23	1	BP218

Pistola de soplado



BP219

BAR	€		
6.3 bar	21,72	1	BP219

Toma de latón

Pistola de soplado con boquilla larga de 330mm



BP219L

BAR	€		
6.3 bar	25,25	1	BP219L

Toma de latón

Pistolas de soplado con entrada de latón y boquilla extralarga de 1 m



BP219XL

BAR	l/min	€		
6.3 bar	100 l/min	22,55	10	BP219XL

Pistola sopladora y aspiradora



BP219V

BAR	€		
6.3 bar	71,90	1	BP219V

Pistola neumática limpiadora



BPN010

BAR	min ⁻¹	€		
6.2 bar	6000-7500 min	201,92	1	BPN010

Limpia (aire & jabón) y seca

EQUIPAMIENTO Y ACCESORIOS PARA HERRAMIENTAS NEUMÁTICAS

Soporte magnético para llaves de impacto



BP500

kg	€		
0.380 kg	55,44	1	BP500

Regulador y Filtro de 1/2"



BP254

l/min	BAR	€		
max 3800 L/min	1-8.5 bar	142,56	1	BP254

Regulador, Filtro y Lubricador de 1/2"



BP255

	BAR	€		
max 3,800 l/min	1-8.5 bar	213,83	1	BP255

Salida de aire limpio seco adicional para unidades de filtro regulador y lubricador de 1/2"



BP255T-1

	BAR	€		
max 3800 l/min	1-8.5 bar	42,72	1	BP255T-1

Manguera espiral de 13 mm



BPH1310

		€		
1/2"-1/2" in	10 m	85,63	1	BPH1310A

Lubricador de 1/4"



BPN251

		€		
1/4" in	0.100 kg	16,08	1	BPN251

Manguera espiral de 10 mm



BPH1010

		€		
1/4"-1/4" NPT in	10 m	47,27	1	BPH1010A
1/4"-1/4" BSP in	10 m	38,37	1	BPH1010B

Adaptador para enrolladores de manguera



BPHRSC

	€		
76 x 88 x 114 mm	94,79	1	BPHRSC

Válidos para BPHRC815 y BPHRC1015

Unidad de filtro regulador y lubricador de 1/2" con salida de aire limpio seco de tipo T



BP255T

	BAR	€		
max 3800 l/min	1-8.5 bar	267,61	1	BP255T

Carrete enrollador de aire comprimido



BPHRC815/1015

		€		
8 mm	15 m	260,14	1	BPHRC815
10 mm	14+1 m	287,59	1	BPHRC1015

Adaptador opcional de control de velocidad de recogida: BPHRSC

Carrete enrollador de aire comprimido



BPHRC1020/1316

		€		
10 mm	20 m	390,88	1	BPHRC1020
13 mm	15+1 m	424,87	1	BPHRC1316

de recogida: BPHRSC



Carrete enrollador de acero



BPHRO1315

		€		
13 mm	13+2 mm	575,20	1	BPHRO1315

Conector neumático giratorio de 1/4"



BPSJ

	€		
1/4" in	30,15	1	BPSJ

Conectores neumáticos giratorios de 1/4" con sistema de bloqueo de la rotación



BPSJL

	€		
1/4" in	35,18	1	BPSJL



Herramientas inalámbricas



LLAVES DE IMPACTO

Pistola de impacto 12V 1/4"



BCL31IW1

V		€		
12 V	1/4"	192,25	1	BCL31IW1

Kit pistola de impacto 12V 1/4"



BCL31IW1K1

	kg	€		
110 x 310 x 390 mm	3.1 kg	332,46	1	BCL31IW1K1

BCL31B1x 2



BCL31C1



BCL31IW1



Pistola de impacto sin escobillas 14,4V 3/8"



BCL32IW1

V		€		
14.4 V	3/8"	339,95	1	BCL32IW1

Pistola de impacto sin escobillas 14,4V 3/8"



BCL32IW1K1

	kg	€		
110 x 310 x 390 mm	3.6 kg	490,12	1	BCL32IW1K1

BCL32IW1



BCL32B1x 2



BCL31C1



Kit pistola de impacto 18V 1/2" con 2 velocidades/selectores de par



BCL33IW1K1

	kg	€		
110 x 310 x 390 mm	5.77 kg	677,37	10	BCL33IW1K1

BCL33C1



BCL33IW1



BCL33B3x 2



Pistola impacto 18V 1/2" con regulación de par



BCL33IW1

V		€		
18 V	1/2"	394,01	1	BCL33IW1

Kit pistola impacto 18V 1/22 alto rendimiento



BCL33IW2K1

	kg	€		
110 x 310 x 390 mm	6.47 kg	825,13	1	BCL33IW2K1

BCL33IW2



BCL33C1



BCL33B3x 2



CARRACAS

Carraca 12V 1/4"



BCL31R1

V		€		
12 V	1/4"	241,41	1	BCL31R1

Kit carraca 12V 1/4"



BCL31R1K1

110 x 310 x 390 mm 3.1 kg 381,82 1 BCL31R1K1

BCL31B1x 2

BCL31C1

BCL31R1

TALADROS Y ATORNILLADORES

Taladro atornillador 18V 13mm-1/2" sin escobillas y portabrocas automático



BCL33D1

18 V 1/2 in 270,92 1 BCL33D1

Kit taladro atornillador 18V 13mm-1/2" sin escobillas y portabrocas automático



BCL33D1K1

110 x 310 x 390 mm 3.7 kg 490,45 1 BCL33D1K1

BCL33C1

BCL33D1

BCL33B1x 2

Taladro atornillador 12V 10mm-3/8" con portabrocas automático



BCL31D1

12 V 360/1550 min 167,50 1 BCL31D1

Kit taladro atornillador 12V 10mm-3/8" con portabrocas automático



BCL31D1K1

110 x 310 x 390 mm 3.15 kg 307,72 1 BCL31D1K1

BCL31B1x 2

BCL31C1

BCL31D1

Atornillador de impacto 12V 1/4"



BCL31IS1

12 V 1/4 in 192,25 1 BCL31IS1

Kit atornillador de impacto 12V 1/4" con kit de cuadradillo de liberación rápida



BCL31IS1K1

110 x 310 x 390 mm 3.1 kg 332,46 1 BCL31IS1K1

BCL31B1x 2

BCL31IS1

BCL31C1

Atornillador 12V 1/4"



BCL31SD1

12 V 1/4 in 167,50 1 BCL31SD1

Kit atornillador 12V 1/4"



BCL31SD1K1

110 x 310 x 390 mm 2.99 kg 307,85 1 BCL31SD1K1

BCL31SD1

BCL31B1x 2

BCL31C1



AMOLADORAS, LIJADORAS Y PULIDORAS INALÁMBRICAS

Lijadora pulidora 14,4V



BCL32SP1

V € 14.4 V 1900/6900 min 251,25 1 BCL32SP1

Pulidora orbital angular 18V



BCL33AP1

V € 18 V 1100-3500 min 332,46 1 BCL33AP1

Kit lijadora pulidora 14,4V



BCL32SP1K1

€ 265 x 290 x 480 mm 3.29 kg 418,76 1 BCL32SP1K1

BCL32SP1	
BCL32B1x 2	
BCL31C1	

Kit pulidora orbital angular 18V



BCL33AP1K1

€ 265 x 290 x 480 mm 5.78 kg 615,75 1 BCL33AP1K1

BCL33AP1	
BCL33B3x 2	
BCL33C1	

Amoladora 14,4V 6mm 21000rpm



BCL32DG1

V € 14.4 V 21000 min 197,07 1 BCL32DG1

Kit amoladora 14,4V 6mm



BCL32DG1K1

€ 110 x 310 x 390 mm 3.2 kg 370,78 1 BCL32DG1K1

BCL32DG1	
BCL32B1	
BCL31C1	

Kit engrasadora 14,4V



BCL32G1K1

€ 265 x 290 x 480 mm 5.22 kg 480,29 1 BCL32G1K1

BCL32G1	
BCL31C1	
BCL32B1x 2	

HERRAMIENTAS DE CORTE

Sierra alternativa 14,4V



BCL32RS1



V € 14.4 V 3000 min 307,85 1 BCL32RS1

Kit sierra alternativa 14,4V



BCL32RS1K1

€ 265 x 290 x 480 mm 3.5 kg 467,99 1 BCL32RS1K1

BCL32RS1	
BCL32B1x 2	
BCL31C1	

ENGRASADORAS

Engrasadora 14,4V



BCL32G1

V		€		
14.4 V	400 g	320,16	1	BCL32G1

BATERÍAS Y CARGADORES

Batería de Lito de 12V y 2Ah





BCL31B1

V		€		
12 V	2 A-h	56,59	1	BCL31B1

Batería de Lito de 14,4V y 2Ah



BCL32B1

V		€		
14.4 V	2 A-h	76,39	1	BCL32B1

Batería de Lito de 18V y 2Ah



BCL33B1

V		€		
18 V	2 A-h	110,91	1	BCL33B1

Batería de Lito de 18V y 5Ah



BCL33B3

V		€		
18 V	2 A-h	169,91	1	BCL33B3

Cargador dual de baterías 12/14.4V y 3A





BCL31C1

V_{in}	V_{out}	€		
220 V	12/14.4 V	83,75	1	BCL31C1

Cargador de baterías 18V y 2.3A



BCL33C1

V_{in}	V_{out}	€		
220 V	18 V	96,06	1	BCL33C1

Cargador rápido de baterías 18V y 3,4A



BCL33C2

V_{in}	V_{out}	€		
220 V	18 V	120,80	1	BCL33C2





BAHCO



Herramientas para automoción



HERRAMIENTAS PARA MOTOR

Juego de calado para motores FCA GROUP 1.4 MULTIAIR



BE501101

68 x 225 x 280 mm € 156,18 1 BE501101

BE50110101



BE50110102



BE50110103



BE50110104



Juego de calado para FCA Group 0.9 petrol Twinair



BE501102

68 x 225 x 280 mm € 157,94 1 BE501102

BE50110201



BE50110202



BE50110203



Juego de calado para FCA Group 1.6-1.9-2.0-2.4 diesel



BE501203

68 x 225 x 280 mm € 141,37 1 BE501203

BE50120301



BE50120302



BE50120303



BE50120305



BE50110103



Polea de cigüeñal para BMW



BE502104

60 x 98 x 269 mm 1726 g € 110,01 8 BE502104

Herramienta de sujeción del cigüeñal para BMW



BE502106

80 x 70 x 260 mm € 51,77 10 BE502106

Juego de calado para FCA Group 1.3 JTD MJ



BE501204

68 x 225 x 280 mm € 214,08 1 BE501204

BE50120401



BE50120402



BE50120403



BE50120404



BE50120405



Juego de calado para BMW 1.8-2.0 petrol

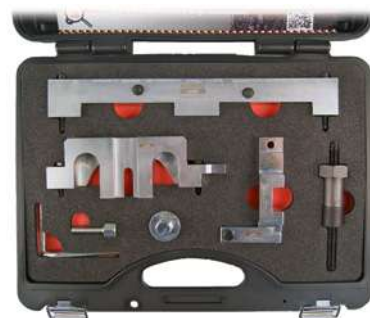

BE502101

95 x 270 x 350 mm € 468,33 1 BE502101

BE50210101



BE50210102



BE50210103



BE50210104



BE50210105



BE50210106



BE50210107



Juego de calado para BMW 1.6 Petrol

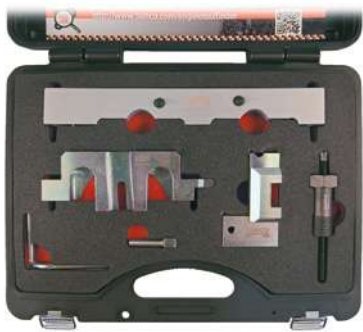

BE502102

270 x 95 x 355 mm € 436,74 1 BE502102

- BE50210103
- BE50210105
- BE50210107
- BE50210201
- BE50210202
- BE50210203

Juego de calado para BMW 1.6-2.0 petrol

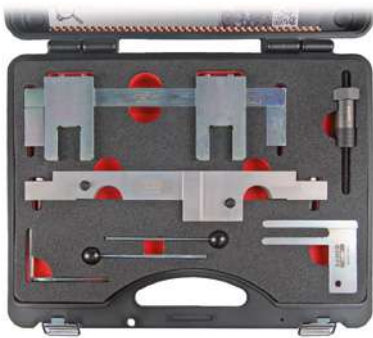

BE502103

80 x 300 x 375 mm € 752,61 1 BE502103

- BE50210301
- BE50210302
- BE50210303
- BE50210305
- BE50210105
- BE50210107

Juego de calado para BMW 2.0 - 2.5 - 3.0 diesel



BE502204

68 x 225 x 280 mm € 188,49 1 BE502204

- BE50220401
- BE50220403
- BE50220404
- BE50220405
- BE50210305

Juego de calado para BMW-mini 1.6-2.0 diesel



BE503201

68 x 225 x 280 mm € 166,96 1 BE503201

- BE50320101
- BE50320102
- BE50320103
- BE50320105
- BE50210305

Juego de calado para MINI-PSA 1.4-1.6 gasolina



BE504102

95 x 270 x 350 mm € 441,63 1 BE504102

- BE50410201
- BE50410202
- BE50410203
- BE50410204
- BE50410206
- BE50210105

Juego de calado para MINI-PSA 1.6 diesel



BE504201

50 x 50 x 220 mm € 80,79 1 BE504201

- BE50420101
- BE50420102
- BE50420103
- BE50420104
- BE50210305



Juego de calado para Ford 1.25-1.4-1.6 gasolina



BE505101

68 x 225 x 280 mm € 156,18 1 BE505101

- BE50510101
- BE50510102
- BE50510103
- BE50510104
- BE50510105
- BE50510106

Juego de calado para FORD 1.0 ECOBOOST gasolina



BE505102

95 x 270 x 350 mm € 677,07 1 BE505102

- BE50510201
- BE50510202
- BE50510203
- BE50510204
- BE50420102
- BE50510102

Juego de calado para FORD 2.0 - 2.2 - 2.4 Duratorq TDCI 16v diesel



BE505203

95 x 270 x 350 mm € 242,36 1 BE505203

- BE50520301
- BE50520302
- BE50520303
- BE50520304
- BE50520305
- BE50520306
- BE50520307

Juego de calado para Ford 1.4-1.6-1.8-2.0-2.2-2.5 diesel



BE505204

95 x 270 x 350 mm € 231,58 1 BE505204

- BE50520401
- BE50520402
- BE50520403
- BE50520404
- BE50520405
- BE50520407
- BE50520411
- BE50520412
- BE50520413
- BE50510104
- BE50420102
- BE50420103
- BE50420104
- BE50510106

Juego de calado para Opel 1.0-1.2-1.4 gasolina



BE506101

50 x 50 x 160 mm € 210,12 1 BE506101

- BE50610101
- BE50610102
- BE50610103
- BE50610104
- BE50610105

Juego de calado para Opel 1.4-1.6-1.8 gasolina



BE506102

68 x 225 x 280 mm € 185,40 1 BE506102

- BE50610201
- BE50610202
- BE50610203
- BE50610204
- BE50610205
- BE50610206

Juego de calado para Opel 1.0-1.2-1.4 Ecoflex gasolina



BE506103

95 x 270 x 350 mm € 495,78 1 BE506103

- BE50610302
- BE50610304
- BE50610102
- BE50610103
- BE50610105

Juego de calado para Opel 2.0 diesel



BE506204

85 x 300 x 375 mm € 288,41 1 BE506204

- BE50620401
- BE50620402
- BE50620403
- BE50620404
- BE50620405

Juego de calado para PSA 1.0-1.1-1.4-1.6-1.8-2.0-2.2 gasolina



BE507101

95 x 270 x 350 mm € 384,55 1 BE507101

- BE50710103
- BE50710104
- BE50710105
- BE50710106
- BE50710107
- BE50710108
- BE50710109
- BE50710110
- BE50710111
- BE50710112
- BE50710101
- BE50710102
- BE50710113
- BE50710114
- BE50710116
- BE50710117
- BE50710118
- BE50710119
- BE50420104

Juego de calado para PSA 1.0-1.2 gasolina



BE507102

68 x 225 x 280 mm € 410,63 1 BE507102

BE50710201



BE50710202



Juego de calado para PSA 1.4-1.5-1.6-1.9-2.0-2.2-2.5 diesel



BE507203

85 x 300 x 375 mm € 403,93 1 BE507203

- BE50720301
- BE50720302
- BE50720304
- BE50720305
- BE50720307
- BE50720308
- BE50720310
- BE50720312
- BE50720314
- BE50720317
- BE50720318
- BE50720319
- BE50720320
- BE50720321
- BE50720322
- BE50720323
- BE50520404
- BE50520411
- BE50710107
- BE50710104
- BE50710113
- BE50710110
- BE50710102
- BE50710106
- BE50420102
- BE50420103



Juego de calado para Renault/Dacia 1.2-1.4-1.6-1.8-2.0 gasolina

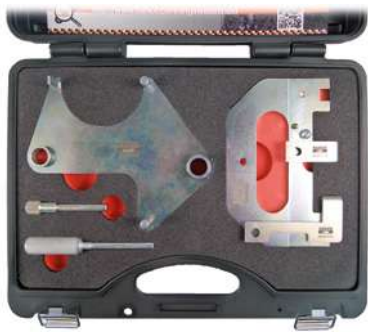

BE508101

	€		
95 x 270 x 350 mm	234,29	1	BE508101

BE50810101	
BE50810102	
BE50810103	
BE50810104	
BE50810105	
BE50810106	

Juego de calado para Renault 1.5-1.9-2.2-2.5 diesel



BE508202

	€		
80 x 300 x 375 mm	315,07	1	BE508202

BE50820201	
BE50820202	
BE50820203	
BE50820204	
BE50820205	
BE50820206	
BE50820207	
BE50820208	
BE50820209	
BE50820211	
BE50810103	
BE50810104	

Juego de calado para Renault 2.0 diesel



BE508203

	€		
68 x 225 x 280 mm	296,64	1	BE508203

BE50820301	
BE50820302	
BE50820303	
BE50820304	
BE50210305	

Juego de calado para Renault -Nissan 1.6 diesel



BE508204

	€		
95 x 270 x 350 mm	421,63	1	BE508204

BE50820402	
BE50820403	
BE50820404	
BE50820302	

Juego de calado para VW Group 1.4-1.6-1.8-2.0 gasolina



BE509101

	€		
80 x 300 x 375 mm	274,68	1	BE509101

BE50910101	
BE50910102	
BE50910103	
BE50910104	
BE50910105	
BE50910106	
BE50910107	
BE50910108	
BE50910109	
BE50910110	
BE50910111	
BE50910112	
BE50910114	
BE50520302	

Juego de calado para VW Group 1.2-1.4-1.6 gasolina



BE509102

	€		
68 x 225 x 280 mm	458,71	1	BE509102

BE50910201	
BE50910202	
BE50910203	
BE50910205	
BE50910206	
BE50910207	
BE50520302	

Juego de calado para VW Group 1.2 TSI gasolina



BE509103

50 x 50 x 210 mm € 79,45 1 BE509103

- BE50910302
- BE50910203

Juego de calado para VW Group 1.0 gasolina



BE509104

68 x 225 x 280 mm € 479,31 1 BE509104

- BE50910401
- BE50910402
- BE50910403
- BE50910404
- BE50910203

Juego de calado para VW Group 1.2-1.4-1.6-1.9-2.0 diesel



BE509205_1

60 x 60 x 220 mm € 70,02 1 BE509205

- BE50910103
- BE50920602
- BE50920603

Juego de calado para VW Group 1.9-2.0 diesel



BE509206

60 x 60 x 220 mm € 71,38 1 BE509206

- BE50920602
- BE50910103
- BE50920703

Juego de calado para VW Group 1.2-1.4-1.6-1.9-2.0 diesel



BE509207

95 x 270 x 350 mm € 282,76 1 BE509207

- BE50920703
- BE50920707
- BE50920708
- BE50920709
- BE50920710
- BE50920711
- BE50910103
- BE50910112
- BE50920602
- BE50920603
- BE50910109
- BE50510102

Juego de calado para VOLVO 1.6 - 1.8 - 1.9 - 2.0 - 2.3 - 2.4 - 2.5 gasolina



BE510101

60 x 60 x 355 mm € 240,34 1 BE510101

- BE51010101
- BE51010102
- BE51010103

Juego de calado para VOLVO 1.6 - 1.8 - 2.0 16v. gasolina



BE510102

50 x 50 x 220 mm € 53,60 1 BE510102

- BE51010201
- BE51010202
- BE50510102
- BE50510105
- BE50510106



Juego de calado para VOLVO 1.6 - 2.0 diesel



BE510203

68 x 225 x 280 mm € 186,78 1 BE510203

- BE50420102
- BE50420103
- BE50420104
- BE50520407
- BE50520411
- BE50510104

Herramienta de sujeción de la polea del cigüeñal para Volvo



BE510304

50 x 145 x 265 mm € 116,74 1 BE510304

Juego de calado para SAAB 1.8i gasolina



BE511101

50 x 50 x 220 mm € 79,65 1 BE511101

- BE51110101
- BE51110102
- BE50610201
- BE50610204

Juego de calado para SAAB 1.6t gasolina



BE511102

50 x 50 x 207 mm € 63,17 1 BE511102

- BE50610201
- BE50610202
- BE50610205
- BE50610203

Juego de calado para SAAB 1.9 - 2.0 - 2.2 Tid diesel



BE511203

80 x 300 x 375 mm € 336,61 1 BE511203

- BE51120301
- BE51120302
- BE51120303
- BE51120304
- BE51120305
- BE50120302
- BE50120303
- BE50120305
- BE50610201

Juego Extracción Bujías M8-M9-M10



BE513201

95 x 270 x 350 mm 2.10 kg € 531,85 1 BE513201

- BE51320101
- BE51320102
- BE51320103
- BE51320104
- BE51320105
- BE51320106
- BE51320107
- BE51320108
- BE51320109
- BE51320110
- BE51320111
- BE51320112
- BE51320113
- BE51320114

Mango amarre de poleas universal



BE523106

410 mm € 62,01 1 BE523106

Juego universal de bloqueo de árbol de levas



BE5100

	€		
345 x 150 x 85 mm	95,67	1	BE5100

Util de cambios de correa sin tensor



BE230

	€		
35 x 145 x 155 mm	179,00	1	BE230

Juego extractor polea alternador



BE500P24

	€		
55 x 270 x 370 mm	148,11	5	BE500P24
	11,56	1	BE500P2401
	11,26	1	BE500P2402
	12,52	1	BE500P2403
	12,68	1	BE500P2404
	13,51	1	BE500P2405
	17,44	1	BE500P2406
	17,44	1	BE500P2407
	6,53	1	BE500P2408



€		
6,47	1	BE500P2409
6,47	1	BE500P2410
6,47	1	BE500P2411
6,47	1	BE500P2412
6,47	1	BE500P2413
17,60	1	BE500P2414
11,96	1	BE500P2415
11,31	1	BE500P2416
11,12	1	BE500P2417
11,56	1	BE500P2418
11,12	1	BE500P2419
11,56	1	BE500P2420
11,56	1	BE500P2421
17,44	1	BE500P2422
11,26	1	BE500P2423
11,26	1	BE500P2424

Compresímetro para motores diesel



BE5401D

	€		
105 x 325 x 410 mm	658,42	1	BE5401D

Bar 0-69 PSI 0-1000

Compresímetro para motores de gasolina



BE5400P

	€		
70 x 160 x 260 mm	181,78	1	BE5400P

Tensímetro de correas



BE239

		€		
38 x 82 x 95 mm	95 mm	94,25	1	BE239

Grosor de correa 2-8mm

Tensiómetro digital de correas



BE240

		€		
60 x 270 x 315 mm	315 mm	992,74	1	BE240

Unidad de medida; Herzios

Libro de datos de valores de tensión para la sincronización y correas accesorias, sincrónica, V & V y forma acanalada.



BE240-CAT

	€		
710 g	107,72	1	BE240-CAT



Termómetro infrarrojos



BLT550

		€		
-50 +550 °C	40 x 95 x 145 mm	75,40	10	BLT550

Campo: 12:1 Precisión: ±1.5% o ±1.5 °C

Juego para línea de combustible 7 piezas



BE257

	€		
68 x 225 x 280 mm	103,36	8	BE257
	17,11	1	BE25710
	17,11	1	BE25718
	12,13	1	BE2572
	15,04	1	BE2576

Kit universal de extracción de inyectores



BE512201

	€		
140 x 415 x 600 mm	2.181,26	1	BE512201

BE51220101	
BE51220102	
BE51220103	
BE51220104	
BE51220105	
BE51220106	
BE51220107	
BE51220108	
BE51220109	
BE51220110	
BE51220111	
BE51220112	
BE51220113	
BE51220114	
BE51220115	
BE51220116	
BE51220117	
BE51220118	
BE51220119	
BE51220120	

Juego de extractores de inyectores



BE1311P13

	€		
80 x 355 x 445 mm	422,79	1	BE1311P13

Juego de vasos para inyectores diesel, 25-27-29-30 mm



BE1310P4

	€		
68 x 225 x 225 mm	114,46	1	BE1310P4

Vaso impacto 1/2" para extraer inyectores diesel



BE1310P425-BE1310P430

		€		
25 mm	1/2 in	27,49	1	BE1310P425
27 mm	1/2 in	30,09	1	BE1310P427
29 mm	1/2 in	32,47	1	BE1310P429
30 mm	1/2 in	32,47	1	BE1310P430

Motores Bosch, Siemens, PSA HDI (2.0)

Juego para limpieza de asientos de inyectores diesel



BE1320S17

	€		
76 x 266 x 355 mm	118,63	10	BE1320S17

Un adaptador de 1/4"

Juego para rectificar asientos de inyectores



BE1315P7

	€		
68 x 225 x 280 mm	121,04	1	BE1315P7
25 x 180 x 275 mm	23,45	1	BE1315P71
20 x 93 x 175 mm	19,67	1	BE1315P72
19 x 93 x 140 mm	24,36	1	BE1315P73
16 x 93 x 140 mm	23,81	1	BE1315P74
20 x 56 x 96 mm	23,81	1	BE1315P75
20 x 56 x 96 mm	24,36	1	BE1315P76
23 x 56 x 96 mm	26,88	1	BE1315P77

Martillo deslizante



BE1300SH

	€		
235 mm	49,82	10	BE1300SH

Extractor de asiento de válvula para inyectores DENSO



BE1312DNS

	€		
	11,44	12	BE1312DNS

Extractor de arandelas de cobre de inyectores



BE1300

	€		
230 mm	95,60	1	BE1300

Set Válvula Lapper



BE762

	g	€		
30 x 90 x 315 mm	68 g	12,88	12	BE762

Alicate desmontador de válvulas



BE76101

	€		
40 x 200 x 290 mm	62,49	1	BE76101

Juego de arandelas de cobre para inyectores



BE1305P450

	€		
40 x 140 x 205 mm	333,91	1	BE1305P450

Set de 30 arandelas de cobre para inyectores

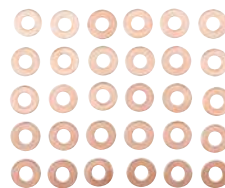

BE1305P450B

	€		
	24,55	1	BE1305P450WS01
	13,24	1	BE1305P450WS02
	20,92	1	BE1305P450WS03
	25,05	1	BE1305P450WS04
	28,63	1	BE1305P450WS05
	32,75	1	BE1305P450WS06
	20,33	1	BE1305P450WS07
	21,53	1	BE1305P450WS08
	26,25	1	BE1305P450WS09
	28,63	1	BE1305P450WS10
	29,16	1	BE1305P450WS11
	17,41	1	BE1305P450WS12
	13,24	1	BE1305P450WS13
	13,24	1	BE1305P450WS14
	29,16	1	BE1305P450WS15

Comprobador de retorno de inyección en motores common rail



BE5350

	€		
84 x 341 x 447 mm	262,57	5	BE5350
10 x 56 x 96 mm	40,00	1	BE5350C1
10 x 56 x 96 mm	40,00	1	BE5350C2
10 x 56 x 96 mm	40,00	1	BE5350C3
10 x 56 x 96 mm	20,68	1	BE5350C4
115 x 65 x 205 mm	168,80	1	BE5350C5



Bomba para tarar inyectores y circuitos diesel



BE13ZL11

		€		
480 x 230 x 280 mm	4.24 kg	605,90	1	BE13ZL11

Juego de 8 vasos con punta Torx® Plus inviolables



BE5008

	€		
40 x 20 x 175 mm	102,21	1	BE5008

TR+10,15,20,25,27,30,40,45

BE5008-45, BE5008-27, BE5008-25,
BE5008-40, BE5008-30, BE5008-10,
BE5008-20, BE5008-15

Vasos 1/4" Torx® Plus Inviolables



BE5008-10/BE5008-45

	€		
10	15,75	1	BE5008-10
15	15,75	1	BE5008-15
20	15,75	1	BE5008-20
25	15,75	1	BE5008-25
27	15,75	1	BE5008-27
30	15,75	1	BE5008-30
40	15,75	1	BE5008-40
45	15,75	1	BE5008-45

Juego de 5 vasos articulados para calentadores bi-hex universal



BE1GP5

		€		
1/4 in	110 x 240 x 40 mm	65,01	1	BE1GP5

BE1GP514, BE1GP510, BE1GP512,
BE1GP58, BE1GP59

Extractor de calentadores



BE1205

		€		
130 mm	35 x 35 x 130 mm	80,79	1	BE1205

Válido para calentadores de 9 y 10mm

Set de 5 insertos M8x1



BE1210P110x

		€		
M8x1	50 g	12,58	1	BE1210P1101
M10x1	50 g	13,57	1	BE1210P1102
M10x1,25	50 g	13,57	1	BE1210P1103

Juego de limpieza de alojamiento de calentadores



BE1200P6

	€		
50 x 115 x 260 mm	152,72	1	BE1200P6

Guía de escariador BE1200P6AC1

Juego de limpieza de alojamiento de calentadores



BE1200P6AC1

	€		
50 x 158 x 192 mm	108,56	1	BE1200P6AC1

Mango en T para calentadores



BE1GP5-T

		€		
1/4 in	400 mm	29,17	10	BE1GP5-T

Herramientas para bujías, calentadores e inyectores



BE1GP58/BE1GP514



Ø	L	€	Icon	Icon	Part No.
8 mm	70 mm	22,52	1		BE1GP58
9 mm	70 mm	22,52	1		BE1GP59
10 mm	70 mm	22,52	1		BE1GP510
12 mm	70 mm	22,52	1		BE1GP512
14 mm	70 mm	22,52	1		BE1GP514

Adaptador flexible para bujías



BE1SP1F

Icon	Icon	€	Icon	Icon	Part No.
30 mm	21 x 330 x 330 mm	28,52	12		BE1SP1F

Vasos para bujías 3/8"



7402GPR

Ø	€	Icon	Icon	Part No.
16 mm	2,94	120		7402GPR-16
18 mm	5,05	120		7402GPR-18
21 mm	3,46	100		7402GPR-21

Juego de reparación de roscado de calentadores



BE1210P11

Icon	€	Icon	Icon	Part No.
50 x 120 x 260 mm	157,54	1		BE1210P11
112 x 13 x 95 mm	107,75	1		BE1210P9AC1

Insertos BE1210P9AC1

Vasos para bujías, cuadrado 3/8", magnético



7406ZZ

Ø	L	€	Icon	Icon	Part No.
16 mm	65 mm	31,97	1		7406ZZ-16
21 mm	64 mm	31,97	1		7406ZZ-21

Llave para bujías



BE1SP

Icon	L	€	Icon	Icon	Part No.
3/8 in	252 mm	26,80	10		BE1SP16L
3/8 in	252 mm	26,80	1		BE1SP14L

Alicates para bujías



BE1P

L	Icon	€	Icon	Icon	Part No.
290 mm	20 x 50 x 290 mm	76,05	1		BE1P

Vasos para bujías 1/2"



7805GPR

Ø	L	€	Icon	Icon	Part No.
16 mm	64 mm	4,87	120		7805GPR-16
21 mm	64 mm	5,30	100		7805GPR-21

Llaves para bujías, articulación cardan



BE1T14/BE1T16/BE1T21

Ø	L	€	Icon	Icon	Part No.
14 mm	65/310 mm	34,74	1		BE1T14
16 mm	63/450 mm	39,72	1		BE1T16
21 mm	67/450 mm	39,14	1		BE1T21



Kit de reparación de roscas para bujías



BE110014/BE110015

g	€		
55 g	20,92	1	BE110014
55 g	102,28	1	BE110015

Kit de reparación de roscas para bujías



BE1100AC1/BE1100AC2

L	€		
9.4 mm	68,12	1	BE1100AC1
15 mm	21,21	1	BE1100AC2

Juego de 9 vasos de 1/2 con punta RIBE, adecuado para motores



BE5102

L	€		
65 x 225 x 225 mm	95,96	1	BE5102

BE51026, BE51025, BE510210,
BE510211, BE510212, BE510213,
BE51027, BE51028, BE51029

Vaso de 1/2" con punta RIBE



BE51025-BE510213

	L	€		
RM5	100 mm	7,87	1	BE51025
RM6	100 mm	7,87	1	BE51026
RM7	100 mm	7,87	1	BE51027
RM8	100 mm	8,25	1	BE51028
RM9	100 mm	8,25	1	BE51029
RM10	100 mm	8,25	1	BE510210
RM11	100 mm	9,63	1	BE510211
RM12	100 mm	10,01	1	BE510212
RM13	100 mm	12,37	1	BE510213

Juego de 6 vasos de 1/2 con punta XZN, adecuado para motores



BE5103

L	€		
65 x 225 x 225 mm	85,62	1	BE5103

BE51036, BE51038, BE510310,
BE510312, BE51035, BE510314

Vasos de 1/2" con punta XZN



BE51035-BE510314

	L	€		
M5	140 mm	8,21	1	BE51035
M6	140 mm	8,21	1	BE51036
M8	140 mm	8,21	1	BE51038
M10	140 mm	8,21	1	BE510310
M12	140 mm	9,94	1	BE510312
M14	140 mm	13,62	1	BE510314

Cepillo para limpiar bujías



52

L	€		
150 mm	4,33	12	52

Cepillo multi-uso



782-U

L	€		
285 mm	6,69	1	782-U

Cepillo para terminales



2555

L	€		
85 mm	8,19	1	2555

Kit de reparación de roscas de bujías



BE1100

		€		
68 x 225 x 280 mm	1.55 kg	324,81	8	BE1100

Kit de reparación de roscas para bujías



BE110001

	€		
60 g	60,93	1	BE110001

Tenaza para segmentos



BE74-55100/BE74-80120

		€		
55-100 mm	20 x 130 x 205 mm	47,18	1	BE74-55100
80-120 mm	20 x 145 x 220 mm	50,02	1	BE74-80120

Ceñidor de segmentos de pistón



BE74-57125/BE74-90175

		€		
80 mm	57-125 mm	48,58	1	BE74-57125
165 mm	90-175 mm	72,86	1	BE74-90175
80 mm	57-125 mm	52,89	1	BE74-57125L

Refractómetro



3046-REF

	€		
150 mm	133,31	1	3046-REF

Comprobador anticongelante



BE401

		€		
50 x 50 x 235 mm	235 mm	10,69	1	BE401

Juego para el control del circuito de refrigeración



BE400P24

	€		
127 x 435 x 510 mm	424,13	1	BE400P24

Comprobador de bombas de tensión con galgas



BE400P241

BAR	PSI	€		
0-2,5 bar	0-36 psi	113,96	1	BE400P241

Conector R123/R124 Negro



BE400P242

	€		
0.035 kg	11,59	1	BE400P242



Conector R123/R125 Azul



BE400P243

	€		
0.06 kg	11,59	1	BE400P243

Adaptador Metálico



BE400P2402

	€		
65 mm	27,90	1	BE400P2402

Adaptador



BE400P2405

	€		
0.065 kg	16,08	1	BE400P2405

Termómetro



BE400P244

	€		
0.02 kg	22,44	1	BE400P244

Adaptador Metálico



BE400P2403

	€		
43.5 mm	24,68	1	BE400P2403

Adaptador



BE400P2406

	€		
0.065 kg	16,08	1	BE400P2406

Adaptador Metálico



BE400P2401

	€		
65 mm	27,90	1	BE400P2401

Adaptador



BE400P2404

	€		
0.055 kg	16,08	1	BE400P2404

Adaptador



BE400P2407

	€		
0.065 kg	16,08	1	BE400P2407

Adaptador



BE400P2408

kg	€		
0.075 kg	16,08	1	BE400P2408

Adaptador



BE400P2411

kg	€		
0.11 kg	16,08	1	BE400P2411

Adaptador



BE400P2414

kg	€		
0.11 kg	16,99	1	BE400P2414

Adaptador



BE400P2409

kg	€		
0.11 kg	16,08	1	BE400P2409

Adaptador



BE400P2412

kg	€		
0.085 kg	16,08	1	BE400P2412

Adaptador para comprobar sistema de refrigeración



BE400P2415

kg	€		
0.075 kg	17,29	1	BE400P2415

Adaptador



BE400P2410

kg	€		
0.085 kg	16,08	1	BE400P2410

Adaptador



BE400P2413

kg	€		
0.065 kg	16,08	1	BE400P2413

Adaptador



BE400P2416

kg	€		
0.065 kg	16,99	1	BE400P2416



Adaptador



BE400P2417

	€		
0.11 kg	16,99	1	BE400P2417

Adaptador



BE400P2418

	€		
0.045 kg	16,99	1	BE400P2418

Adaptador



BE400P2419

	€		
0.075 kg	16,99	1	BE400P2419

Llave de plástico para radiador



BE400P2420

	€		
0.005 kg	42,89	1	BE400P2420

Equipo para purga y relleno del líquido de refrigeración



BE410

	€		
80 x 300 x 375 mm	263,90	4	BE410
45 x 45 x 105 mm	11,58	1	BE4101

Juego para el reemplazo de juntas



BE700

	€		
90 x 200 x 43 mm	85,56	1	BE700
	78,86	1	BE700BP2
	37,19	1	BE700SP15

Juego de puntas de 10mm



BE5032

	€		
65 x 225 x 225 mm	90,95	1	BE5032

BE5049M5, BE5049M6, BE5049M8, BE5049M10, BE5049M12, BE5032M14		
BE5049T20, BE5049T25, BE5049T27, BE5049T30, BE5049T40, BE5049T45, BE5049T50, BE5049T55, BE5049T60		
BE5049H5, BE5049H6, BE5049H8, BE5049H10, BE5049H12, BE5032H14		
BE5032SQ8, BE5032SQ10		
BE5049H6L, BE5049H8L, BE5032H10EL		
BE5049T45L, BE5032T55EL		
BE5049M8L, BE5049M10L, BE5049M12L		
BE504901		

Caja 5 Puntas Robertson de 10 mm



BE5032SQ



		€		
#8 mm	30 mm	24,77	1	BE5032SQ8
#10 mm	30 mm	29,94	1	BE5032SQ10

Vasos de 1/2" con punta TORX® inviolables



BE510125-BE510160

		€		
TR25	100 mm	7,08	1	BE510125
TR27	100 mm	7,08	1	BE510127
TR30	100 mm	7,08	1	BE510130

		€		
TR40	100 mm	7,08	1	BE510140
TR45	100 mm	7,43	1	BE510145
TR50	100 mm	7,43	1	BE510150
TR55	100 mm	7,43	1	BE510155
TR60	100 mm	8,89	1	BE510160

Juego para retenes de cigüeñal y árbol de levas



BE5150P27

	€		
80 x 270 x 375 mm	370,90	1	BE5150P27
56 x 56 x 96 mm	123,06	1	BE5150P271
80 x 80 x 195 mm	34,37	1	BE5150P272
170 x 160 x 385 mm	224,42	1	BE5150P273

Juego de herramientas para reparación de A/A 12 pzas



BE800P12

	€		
43 x 90 x 200 mm	72,72	1	BE800P12

Juego para soltar conectores rápidos



BAC007

	kg	€		
240 mm	0,075 kg	12,12	1	BAC007

Medidas: 1/4", 5/16", 3/8", 1/2", 5/8", 3/4", 7/8"

Barra soporte para motores



BH8AC1-500

	kg	€		
150 x 165 x 1800 mm	20,71 kg	160,11	1	BH8AC1-500

Soporte para motores 500kg



BH8AC2-500

	€		
500 kg	472,24	1	BH8AC2-500

Alicate para abrazaderas 45°



BE250

	g	€		
190 mm	245 g	47,13	1	BE250

Alicates con Puntas Giratorias



BE251A

	g	€		
30 x 55 x 220 mm	228 g	47,13	12	BE251A

Alicate de sirga para abrazaderas EGR



BE253

	€		
870 mm	119,84	1	BE253



Alicates con sirga para abrazaderas



BE254A

	€		
18-53 mm	112,93	1	BE254A

Cable para alicates BE253, BE254 y BE255



BE2542

		€		
630 mm	20 g	6,33	1	BE2542

Alicata para abrazaderas OETIKER™



BPOC15

	€		
275 mm	79,47	12	BPOC15

Kit de reparación para BE254A



BE254A-01

		€		
590 mm	130 g	41,05	1	BE254A-01

Estrangulador de latiguillos



BE256M

	€		
40 x 45 x 310 mm	45,76	1	BE256M

Juego de 3 alicates para latiguillos



BE256P3

	€		
40 x 93 x 330 mm	33,67	1	BE256P3
15 x 55 x 155 mm	9,43	1	BE256-155
20 x 45 x 185 mm	12,12	1	BE256-178
10 x 55 x 250 mm	16,15	1	BE256-250

Kit reparación para alicata BE254



BE2541

	€		
100 g	16,58	1	BE2541

Alicata para abrazaderas elásticas



BE258

		€		
12-55 mm	285 mm	124,62	1	BE258

Juego de 6 vasos acanalados



BE5500

	€		
10/11/12/14/17/19	53,06	25	BE5500

Juego de vasos acanalados



BE5500-10/BE-5500-19

		€		
3/8 in	10	9,84	1	BE550010
3/8 in	11	9,84	1	BE550011
3/8 in	12	9,84	1	BE550012
3/8 in	14	9,84	1	BE550014
1/2 in	17	10,29	1	BE550017
1/2 in	19	10,61	1	BE550019

Alicates para líneas de combustible



BE6FCP

		€		
104 mm	218 mm	44,41	30	BE6FCP

Juego de alicates para desconexión de conductos de combustible de 8 y 10mm



BE1FLDS

	€		
8-10 mm	44,44	1	BE1FLDS

BE1FLD2, BE1FLD3, BE1FLD1

Alicates desconexión de combustible



BE1FLD1/BE1FLD3

	€		
10 mm	16,30	1	BE1FLD1
8 mm	16,30	1	BE1FLD2
18.5 mm	16,30	1	BE1FLD3

Extractor universal de aforador de combustible



BE1FTW

	€		
75-160 mm	67,86	1	BE1FTW

Llave de filtro de combustible para Ford 2.2TDCi



BE1FFWF

	€		
5 x 142 x 169 mm	23,56	12	BE1FFWF

Juego de 6 leznas



2633HD/S6

	€		
80 x 270 x 375 mm	132,85	1	2633HD/S6
42 x 93 x 290 mm	43,12	1	2633HD1
30 x 85 x 215 mm	19,07	1	2633HD2
30 x 93 x 200 mm	16,54	1	2633HD3
20 x 87 x 165 mm	12,77	1	2633HD4
10 x 60 x 120 mm	12,04	1	2633HD5
10 x 10 x 155 mm	6,95	1	2633HD6

Juego de 5 llaves en T de 4-5-6-8 y 10 mm



BE1TH-S5

	€		
5	88,76	1	BE1TH-S5

Juego de 6 llaves en T con puntas hexagonales, 2,5-3-4-5-6-8mm



BE1TH-S6

	€		
6	99,64	30	BE1TH-S6

BE1TH-4, BE1TH-8, BE1TH-2.5, BE1TH-3, BE1TH-6, BE1TH-5



LLAVES EN T CON PUNTAS HEXAGONALES



BE1TH

mm	g	€	Paquete	Icono
10 mm	385 g	29,95	5	BE1TH-10
12 mm	571 g	36,37	5	BE1TH-12
2 mm	15 g	17,23	10	BE1TH-2
2.5 mm	20 g	17,23	10	BE1TH-2.5
3 mm	23 g	17,70	10	BE1TH-3
3.5 mm	23 g	17,70	10	BE1TH-3.5
4 mm	60 g	20,13	10	BE1TH-4
4.5 mm	60 g	20,86	10	BE1TH-4.5
5 mm	60 g	21,54	10	BE1TH-5
6 mm	127 g	23,84	10	BE1TH-6
7 mm	205 g	27,42	10	BE1TH-7
8 mm	205 g	27,42	10	BE1TH-8
9 mm	385 g	29,95	10	BE1TH-9

Juego de 7 llaves en T con vaso giratorio, 7-8-10-12-13-14-17mm

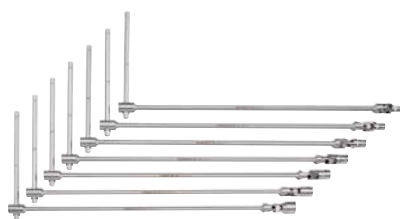

BE1TS-S7

Paquete	€	Icono
7	187,94	1 BE1TS-S7

BE1TS-17, BE1TS-13, BE1TS-14, BE1TS-12, BE1TS-7, BE1TS-8, BE1TS-10

LLAVES EN T CON VASO GIRATORIO



BE1TS

mm	g	€	Paquete	Icono
10 mm	485 g	29,62	10	BE1TS-10
11 mm	485 g	29,88	10	BE1TS-11
12 mm	475 g	30,69	10	BE1TS-12
13 mm	485 g	31,37	10	BE1TS-13
14 mm	485 g	31,37	10	BE1TS-14
15 mm	485 g	34,00	10	BE1TS-15
16 mm	495 g	34,00	10	BE1TS-16
17 mm	495 g	34,00	10	BE1TS-17
18 mm	510 g	37,16	10	BE1TS-18
19 mm	495 g	37,16	10	BE1TS-19
20 mm	730 g	43,90	8	BE1TS-20
21 mm	765 g	24,56	8	BE1TS-21
22 mm	745 g	44,03	8	BE1TS-22
24 mm	745 g	40,26	8	BE1TS-24
6 mm	475 g	25,86	10	BE1TS-6
7 mm	475 g	25,86	10	BE1TS-7
8 mm	485 g	28,42	10	BE1TS-8
9 mm	475 g	29,62	10	BE1TS-9

Llave en T, 1/2"



1945W

mm	L	€	Paquete	Icono
1/2 in	311 mm	56,41	6	1945W12
1/4 in	311 mm	36,88	8	1945W14
3/8 in	311 mm	44,47	6	1945W38

Juego de Puntas 10mm



BE5049

Paquete	kg	€	Icono
55 x 190 x 320 mm	3.56 kg	114,46	5 BE5049

Adaptador 1/2" para puntas 10 mm



BE504901

mm	L	€	Paquete	Icono
10 mm	36 mm	12,35	1 BE504901	

Caja 5 Puntas hexagonales, 10mm



BE5049H

mm	L	€	Paquete	Icono
4 mm	30 mm	14,92	1	BE5049H4
5 mm	30 mm	14,92	1	BE5049H5
6 mm	30 mm	14,92	1	BE5049H6
7 mm	30 mm	14,92	1	BE5049H7
8 mm	30 mm	14,92	1	BE5049H8
10 mm	30 mm	14,92	1	BE5049H10
12 mm	30 mm	18,57	1	BE5049H12
14 mm	30 mm	31,45	1	BE5032H14

Caja 5 Puntas XZN, 10mm



BE5049M

	L	€		
M5	30 mm	14,92	1	BE5049M5
M6	30 mm	14,92	1	BE5049M6
M8	30 mm	14,92	1	BE5049M8
M10	30 mm	14,92	1	BE5049M10
M12	30 mm	18,57	1	BE5049M12
M14	30 mm	35,39	1	BE5032M14

Caja 5 puntas TORX®, 10 mm



BE5049T

	L	€		
T20	30 mm	14,42	1	BE5049T20
T25	30 mm	14,42	1	BE5049T25
T27	30 mm	14,42	1	BE5049T27
T30	30 mm	14,42	1	BE5049T30
T40	30 mm	14,42	1	BE5049T40
T45	30 mm	14,42	1	BE5049T45
T50	30 mm	14,42	1	BE5049T50
T55	30 mm	14,42	1	BE5049T55
T60	30 mm	21,12	1	BE5049T60

Caja 5 Puntas Torx® inviolable, 10mm



BE5049T_H

	L	€		
TR20	30 mm	14,92	1	BE5049T20H
TR25	30 mm	14,92	1	BE5049T25H
TR27	30 mm	14,92	1	BE5049T27H
TR30	30 mm	14,92	1	BE5049T30H
TR40	30 mm	14,92	1	BE5049T40H
TR45	30 mm	14,92	1	BE5049T45H
TR50	30 mm	14,92	1	BE5049T50H

	L	€		
TR55	30 mm	14,92	1	BE5049T55H
TR60	30 mm	21,60	1	BE5049T60H

Juego de 9 vasos de 1/2 con punta TORX®, inviolables



BE5101

	€		
65 x 225 x 225 mm	95,96	1	BE5101

BE510150, BE510145, BE510160, BE510155, BE510127, BE510125, BE510140, BE510130

Comprobador de presión de aceite motor



BE5200

	€		
85 x 355 x 445 mm	200,63	1	BE5200
25 x 105 x 195 mm	167,26	1	BE530001
	22,84	1	BE52001
	22,84	1	BE52002
	104,45	1	BE52003

Adaptador de 3/8" para puntas de 10 mm



BE504902

	L	€		
10 mm	28 mm	10,07	1	BE504902

Caja 5 Puntas hexagonales, 10mm

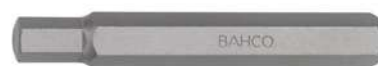

BE5049H_L

	L	€		
4 mm	75 mm	22,12	1	BE5049H4L
5 mm	75 mm	22,12	1	BE5049H5L
6 mm	75 mm	22,12	1	BE5049H6L
7 mm	75 mm	22,12	1	BE5049H7L
8 mm	75 mm	22,12	1	BE5049H8L
10 mm	75 mm	22,12	1	BE5049H10L
10 mm	115 mm	10,74	1	BE5032H10EL
12 mm	75 mm	29,69	1	BE5049H12L

Caja 5 Puntas XZN, 10mm serie larga 75mm



BE5049M_L

	L	€		
M5	75 mm	22,12	1	BE5049M5L
M6	75 mm	22,12	1	BE5049M6L
M8	75 mm	22,12	1	BE5049M8L
M10	75 mm	22,12	1	BE5049M10L
M12	75 mm	29,69	1	BE5049M12L



Juego puntas TORX 49 piezas



BE5049t

		€		
55 x 190 x 320 mm	3.54 kg	114,46	1	BE5049T

Caja 5 Puntas TORX® inviolable, 10mm

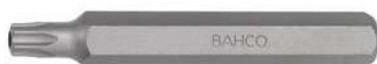

BE5049T_HL

		€		
TR20	75 mm	22,12	1	BE5049T20HL
TR25	75 mm	22,12	1	BE5049T25HL
TR27	75 mm	22,12	1	BE5049T27HL
TR30	75 mm	22,12	1	BE5049T30HL
TR40	75 mm	22,12	1	BE5049T40HL
TR45	75 mm	22,12	1	BE5049T45HL
TR50	75 mm	22,12	1	BE5049T50HL
TR55	75 mm	22,12	1	BE5049T55HL
TR60	75 mm	32,34	1	BE5049T60HL
TR70	100 mm	32,34	1	BE5049T70HL
TR80	70 mm	32,34	1	BE5049T80HL
TR30	200 mm	22,22	1	BE5049T30HXL
TR40	200 mm	22,22	1	BE5049T40HXL
TR45	200 mm	22,22	1	BE5049T45HXL

Caja 5 puntas TORX® 10 mm, serie larga

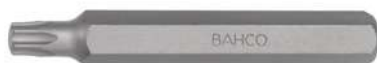

BE5049T_L

		€		
T20	75 mm	21,60	1	BE5049T20L
T25	75 mm	21,60	1	BE5049T25L
T27	75 mm	21,60	1	BE5049T27L
T30	75 mm	21,60	1	BE5049T30L

		€		
T40	75 mm	21,60	1	BE5049T40L
T45	75 mm	21,60	1	BE5049T45L
T50	75 mm	21,60	1	BE5049T50L
T55	75 mm	21,60	1	BE5049T55L
T55	115 mm	11,85	1	BE5032T55EL

HERRAMIENTAS PARA SISTEMAS DE ESCAPE

Extractor de humos de accionamiento neumático



BUCPE

		€		
5000 mm	1263 x 306 x 300 mm	754,01	1	BUCPE
105 mm	15 x 105 x 105 mm	6,74	1	BUCPEF1
121 mm	60 x 121 x 121 mm	77,90	1	BUCPEF

Opcional: Manguito extensible de 3m (BUCPE3SH) y tubo doble de escape (BUCPE3SDH)

Tubo doble de escape para BUCPE



BUCPE3SH

		€		
3000 mm	63,5 mm	200,03	1	BUCPE3SH

Manguito extensible de 3mm para BUCPE



BUCPE3SDH

		€		
420 x 530 x 3000 mm	3000 mm	203,66	1	BUCPE3SDH

Vaso de 1/2" para sondas lambda



7812

		€		
22 mm	78 mm	13,53	100	7812

Alicate universal para escapes



BUC50

		€		
65 mm	305 mm	64,63	1	BUC50

Alicate para desmontaje de escapes



BUC110

		€		
360 mm	50 x 65 x 360 mm	46,46	1	BUC110

Llaves para filtros de aceite/combustible



BE60FW

		€		
57-120 mm	18 x 95 x 325 mm	60,95	5	BE60FW

Llave de filtro de cadena



BE64520/BE64350

		€		
350 mm	60-105 mm	53,18	1	BE64350
350 mm	60-105 mm	39,72	1	BE64350CH
520 mm	60-160 mm	63,29	1	BE64520
520 mm	60-160 mm	50,02	1	BE64520CH

Separador tramos de escape universal



BUC100

		€		
34-54 mm	320 mm	100,99	1	BUC100

Llave de fleje



BE611

		€		
65-105 mm	25 x 55 x 210 mm	35,59	12	BE61110
65-105 mm	1 x 12 x 382 mm	5,93	100	BE61110-1
100-155 mm	37 x 75 x 275 mm	38,48	12	BE61155
100-155 mm	1 x 12 x 529 mm	7,70	1	BE61155-1

Llave con cinta de goma



BE66152A

		€		
150 mm	95 x 170 x 220 mm	21,77	6	BE66152A

HERRAMIENTAS Y EQUIPAMIENTOS PARA CAMBIOS DE ACEITE

Llave para filtro de combustible HDi 108mm



BE60F108

		€		
3/8 in	108 mm	33,79	50	BE60F108

Llave de fleje para filtros de aceite con mango de goma



BE62

		€		
65-105 mm	42.5 x 57 x 249 mm	38,18	10	BE62110
110-155 mm	42.5 x 85 x 314 mm	41,41	10	BE62155

Llave de filtro 3 garras planas



BE65F65120

		€		
3/8 in	65-120 mm	14,82	12	BE65F65120



Extractores de filtro 3 patas magnético



BE65R

Icon	Icon	€	Icon	Icon
3/8-1/2 in	65-120 mm	29,62	1	BE65R65120
3/8-1/2 in	80-119 mm	113,10	1	BE65R80120
1/2 in	105-160 mm	131,95	1	BE65R106160

Juego de cazoletas para filtros de aceite



BE630

Icon	€	Icon	Icon
87 x 505 x 610 mm	185,81	3	BE630

Cazoletas para filtro individuales



BE630 Parts

Icon	Icon	€	Icon	Icon
66 mm	Fiat, Renault	13,46	1	BE630666F
64 mm	Daihatsu, Fiat, Nissan, Toyota	13,46	12	BE6306514F
65-66 mm	Daihatsu, Toyota	13,46	12	BE630656714F
66 mm	Ford, Mazda, Subaru	13,46	1	BE6306814F

Icon	Icon	€	Icon	Icon
73 mm	Alfa Romeo, Lexus, Toyota	13,46	1	BE6307314F
74 mm	Audi, Chrysler, GM, Rover	13,46	1	BE6307415F
74-76 mm	Audi, Ford, Mercedes Benz, Opel, VW	13,46	12	BE630747615F
74-75 mm	Audi, Ford, Isuzu, Mercedes Benz, Opel, VW	13,46	1	BE630757715F
76 mm	Fiat, Mercedes Benz, Renault	13,46	12	BE6307612F
74 mm	Audi, BMW, Mercedes Benz, Opel, Porsche, VW	13,46	12	BE6307614F
74 mm	Ford	13,46	1	BE6307630F
74 mm	Fiat, Lancia	13,46	1	BE630768F
78 mm	Ford, Honda, Nissan, Toyota	13,46	12	BE6307815F
80 mm	Honda, Isuzu, Mazda, Nissan, Opel, Subaru, Toyota	13,46	1	BE6308015F
80-82 mm	Acura, Honda, Mazda, Nissan, Subaru, Toyota	13,46	1	BE630808215F
86 mm	Volvo	13,46	1	BE6308616F
86 mm	Audi, Citroen, Peugeot, Renault, VW	13,46	1	BE6308618F
89 mm	Honda, Isuzu, Mitsubishi	13,46	12	BE6309015F
92 mm	Fiat, Lancia	13,46	1	BE6309210F
92 mm	Audi, Ford, Honda, Mazda, Mitsubishi, Nissan, Opel, Porsche, Renault, Volvo, VW	13,46	1	BE6309315F
93 mm	Ford	13,46	1	BE6309336F
93 mm	Audi, VW	13,46	1	BE6309345F
95 mm	Alfa Romeo, Chrysler, Ford, Toyota	13,46	1	BE6309515F
96 mm	Audi, Renault, VW	13,46	1	BE6309618F
101 mm	Isuzu, Mitsubishi	13,46	25	BE63010015F
24 mm	BMW	26,00	50	BE630246F
106 mm	Fiat, MAN, Scania	13,46	1	BE63010615F
27 mm	Mercedes Benz	26,00	50	BE630276F
107 mm	Volvo	13,46	1	BE63010815F
32 mm	GM, Mercedes Benz, Opel, Saab	26,00	50	BE630326F
108 mm	Renault	13,46	1	BE63010818F
36 mm	BMW, Ford, Mercedes Benz, Opel, Rover, VW	26,00	100	BE630366F
38 mm	BMW, Opel, Volvo	26,00	50	BE630386F
66.5 mm	Daihatsu, Toyota	26,00	25	BE63066514F

Llave de filtro de aceite de 27 mm para Ford y Grupo PSA



BE6302712F

Icon	Icon	€	Icon	Icon
1/2 in	27 mm	22,65	5	BE6302712F

Llave para filtro de aceite para Toyota, Lexus, Subaru, Daihatsu con 4 cilindros (1,8 a 2,0L)



BE63064514F1

Icon	Icon	€	Icon	Icon
Toyota, Lexus, Subaru, Daihatsu 4 cylinders (1.8-2.0l)	64.5 mm	23,56	1	BE63064514F1

Llave para filtro de aceite para Toyota, Lexus, Subaru, Daihatsu con 4, 6 o 8 cilindros (2,5L a 5,7L)



BE63064514F2

Icon	Icon	€	Icon	Icon
Toyota, Lexus, Subaru, Daihatsu 4, 6, 8 cylinders (2.5-5.7L)	64.5 mm	24,10	1	BE63064514F2

Cazoleta para filtros de aceite 74 mm 14 caras



BE6307414F

		€		
14	1	19,41	10	BE6307414F

Llave para tapón de carter con sección cuadrada



BE68

		€		
8 in	265 mm	31,40	12	BE6810Z
8 in	235 mm	6,58	1	BE68
8 x 10 mm	270 mm	13,33	1	BE6810

BE68: Cuadrado 8mm BE6810: Cuadrado 8-10mm

Extractor bomba sumidero 1/4" VW-AUDI



BE6701VAG

		€		
10 x 50 x 125 mm	0.02 kg	24,24	1	BE6701VAG

Juego de 17 vasos para cambio de aceite



BE6217

	€		
55 x 105 x 220 mm	82,14	1	BE6217

Vasos para cambio de aceite de 3/8"



BE621701-BE621717

	mm	€		
6	8 mm	6,42	1	BE621701
6	9 mm	6,42	1	BE621702
6	10 mm	6,42	1	BE621703
6	12 mm	6,42	1	BE621704
6	13 mm	6,42	1	BE621705
6	14 mm	6,42	1	BE621706
6	17 mm	6,42	1	BE621707
4	8 mm	6,42	1	BE621708
4	9.5 mm	6,42	1	BE621709
4	10 mm	6,42	1	BE621710
4	10.5 mm	6,42	1	BE621711
4	11 mm	6,42	1	BE621712
4	12 mm	6,42	1	BE621713
4	13.1 mm	6,42	1	BE621714
4	10 mm	6,42	1	BE621715
3	10 mm	14,09	1	BE621716
xZN	M16 mm	14,09	1	BE621717

Juego de tapones y arandelas para cárter



BOD10P64

	€		
68 x 225 x 280 mm	133,31	8	BOD10P64

Juegos de tapones y arandelas para cárter



BOD10

	€		
34 x 93 x 105 mm	51,66	1	BOD101
35 x 95 x 105 mm	54,63	1	BOD102
33 x 93 x 105 mm	54,63	1	BOD103
33 x 93 x 105 mm	59,05	1	BOD104
33 x 93 x 105 mm	62,00	1	BOD105
95 x 105 x 35 mm	67,18	1	BOD106

Juego tapones y arandelas



BOD10XNWS

	€		
M13x1.25	38,51	1	BOD101NWS
M13x1.5	42,90	1	BOD102NWS
M15x1.5	38,51	1	BOD103NWS
M17x1.5	42,43	1	BOD104NWS
M20x1.5	42,43	1	BOD105NWS
M22x1.5	56,83	1	BOD106NWS



Recogedora de aceite por gravedad y aspiración, con cámara de visualización 90L



BOD8903A

	€		
1700 x 419 x 608 mm	801,14	1	BOD8903A

Recogedora de aceite por gravedad y aspiración, 90L



BOD8902

	kg	€		
1000 x 413 x 632 mm	38 kg	713,62	1	BOD8902

Recogedora de aceite por gravedad, 90L



BOD8901

	kg	€		
1000 x 413 x 630 mm	32 kg	552,04	1	BOD8901

Embudo extensible para Aspiroil



BOD8901AC1

	€		
620 x 620 x 150 mm	89,04	1	BOD8901AC1

Equipo de llenado de cambios automáticos



BOD6080P12

	€		
595 x 255 x 330 mm	437,61	1	BOD6080P12

Tanque 8L

Adaptador para juego BOD6080P12



BOD6080P12-01

g	€		
35 g	20,33	1	BOD6080P12-01

Adaptador para juego BOD6080P12



BOD6080P12-02

g	€		
55 g	26,14	1	BOD6080P12-02

Adaptador para juego BOD6080P12



BOD6080P12-03

g	€		
45 g	26,14	1	BOD6080P12-03

Adaptador para juego BOD6080P12



BOD6080P12-04

g	€		
6 g	26,14	1	BOD6080P12-04

Adaptador para juego BOD6080P12



BOD6080P12-05

	€		
25 g	20,33	1	BOD6080P12-05

Adaptador para juego BOD6080P12



BOD6080P12-06

	€		
25 g	24,17	1	BOD6080P12-06

Adaptador para juego BOD6080P12



BOD6080P12-07

	€		
45 g	21,16	1	BOD6080P12-07

Adaptador para juego BOD6080P12



BOD6080P12-08

	€		
45 g	24,17	1	BOD6080P12-08

Adaptador para juego BOD6080P12



BOD6080P12-09

	€		
15 g	20,33	1	BOD6080P12-09

Adaptador para juego BOD6080P12



BOD6080P12-10

	€		
85 g	28,12	1	BOD6080P12-10

Adaptador para juego BOD6080P12



BOD6080P12-11

	€		
105 g	24,17	1	BOD6080P12-11

Aceiteras



BOD4200/BOD4500

		€		
0.2l	158 x 86 x 128 mm	9,83	1	BOD4200
0.5l	158 x 86 x 128 mm	11,98	1	BOD4500

Embudo 1,2L



BOD301200

	€		
225 x 165 x 165 mm	28,28	1	BOD301200

Recogedora de aceite



BOD2008

		€		
8 l	115 x 325 x 590 mm	45,10	1	BOD2008

Recogedora de aceite



BOD1016

		€		
16 l	170 x 450 x 570 mm	39,06	1	BOD1016



Macho roscado para tapón de aceite



BOD10XT

L	Ø	€	Icon 1	Icon 2	Code
92 mm	M13x1.25	18,43	1		BOD101T
70 mm	M13x1.5	22,96	1		BOD102T
70 mm	M15x1.5	18,43	1		BOD103T
70 mm	M17x1.5	23,71	1		BOD104T
70 mm	M20x1.5	26,12	1		BOD105T
70 mm	M22x1.5	22,33	1		BOD106T

Bomba de trasvase para 50-205L con conexiones 1/2" y 2"



BOD60

Icon 1	€	Icon 2	Icon 3	Code
875 x 57 x 245 mm	52,52	1		BOD60

Manguera flexible de alta resistencia para bombas de engrase



BOD54-1 / -2

Ø	Ø	€	Icon 1	Icon 2	Code
4.1 mm	10.8 mm	11,37	1		BOD54-1
4.1 mm	10.8 mm	13,57	1		BOD54-2

Envase de 2L con boca flexible



BOD2FS

Icon 1	Icon 2	€	Icon 3	Icon 4	Code
2l	330 x 130 x 380 mm	15,40	20		BOD2FS

Bomba de engrase profesional



BOD5HD400

Icon 1	€	Icon 2	Icon 3	Code
60 x 115 x 360 mm	55,15	1		BOD5HD400

Boquilla para engrasadoras



BOD54-3

L	€	Icon 1	Icon 2	Code
37 mm	9,14	1		BOD54-3

Presión máx 500Bar

Bomba de Barril rotativa



BOD70

Icon 1	€	Icon 2	Icon 3	Code
230 x 250 x 1330 mm	152,51	1		BOD70

Bomba de engrase universal



BOD5400/BOD5450

Icon 1	€	Icon 2	Icon 3	Code
55 x 120 x 390 mm	35,72	1		BOD5400
65 x 125 x 385 mm	59,35	1		BOD5450

HERRAMIENTAS Y EQUIPOS PARA SISTEMAS DE FRENADO

Tester para líquido de frenos, en pluma



BBR100

Icon 1	€	Icon 2	Icon 3	Code
20 x 20 x 150 mm	47,13	1		BBR100

Comprobador líquido de frenos



BBR110

	€		
35 x 65 x 160 mm	100,99	1	BBR110

Llaves para sangradores de freno



BBR501011-121314

		€		
10 / 11 mm	3/8 in	72,04	50	BBR501011
12 / 14 mm	3/8 in	72,04	50	BBR50121314

Purgador de frenos



BBR350

		€		
1/4" in	300 x 125 x 125 mm	200,63	1	BBR350

Purgador electrico de frenos 12V



BBRBB12

		€		
895 x 390 x 395 mm	14.6 kg	1.714,82	1	BBRBB12

Juego de adaptadores para tapones de líquido de frenos



BBRAS14

		€		
PN5 in	85 x 350 x 445 mm	291,19	4	BBRAS14

1 kit de accesorios para adaptadores

Adaptadores para tapones de líquido de frenos



BBRAS14-01/BBRAS14-14

		€		
PN5 in	Universal	53,95	1	BBRAS14-01
PN5 in	Honda	26,00	1	BBRAS14-02
PN5 in	Honda Accord	23,12	1	BBRAS14-03
PN5 in	Universal	34,65	1	BBRAS14-04
PN5 in	Chrysler, Jeep, Plymouth	7,71	1	BBRAS14-05
PN5 in	Chrysler, Jeep, Plymouth, Dodge	8,67	1	BBRAS14-06
PN5 in	Nissan	12,53	1	BBRAS14-07
PN5 in	Alfa Romeo, Fiat, Peugeot, Citroën, Audi, BMW, Jaguar, Land-Rover, Mercedes, Porsche, Renault, Saab, VW, Volvo, Chrysler, Daewoo, Ford, Kia, Mazda, Mini, etc	14,24	1	BBRAS14-08
PN5 in	Hyundai, Mitsubishi, Nissan, Subaru, Chrysler, Dodge, Ford, etc.	14,81	1	BBRAS14-09
PN5 in	GM Models and Mazda	12,07	1	BBRAS14-10
PN5 in	Toyota and Lexus	65,93	1	BBRAS14-11
N/A in	Holder for universal adaptor	9,52	1	BBRAS14-12
N/A in	Syringe	21,60	1	BBRAS14-13
N/A in	Hooks, chains and roulettes for BBRAS14-01 and BBRAS14-04	10,59	1	BBRAS14-14

Juego galgas para pastillas de freno



BBRPTG1

	€		
68 g	20,58	10	BBRPTG1



Comparador con soporte magnético



1154

	€		
230 x 50 x 75 mm	141,47	1	1154

1154-DG

1154-MB

Reloj comparador



1154-DG

		€		
0-10 mm	0.01 mm	77,10	1	1154-DG

Rango medición: 0-10mm Incremento medición: 0,01mm

Base magnética



1154-MB

		€		
70 x 96 x 297 mm	230 + 150 mm	57,17	1	1154-MB

Calibre de aluminio



BBR400

	€		
6 x 89 x 120 mm	37,70	1	BBR400

Calibre digital para discos de freno



BBR420

		€		
0-60 mm	35 x 104 x 176 mm	85,42	50	BBR420

Calibre para discos y tambores de freno.



BBR410

		€		
20 x 210 x 280 mm	0.610 kg	51,15	24	BBR410

Calibre digital para discos y tambores de freno



BBR405

	€		
460 mm	197,78	20	BBR405

Cepillo para limpiar discos de freno



783

	€		
223 mm	13,58	1	783

Reposicionador neumático pistones de frenos



BBR320

		€		
3/8 in	1/4" in	100,31	1	BBR320

Set para calibre de frenos universal de 50 piezas



BBR300P50

		€		
82 x 350 x 425 mm	5.56 kg	263,90	4	BBR300P50

Juego de 9 vasos de 1/2" con punta TORX® de impacto para frenos



BBR203P9

	€		
68 x 225 x 225 mm	116,63	1	BBR203P9

BBR203P925, BBR203P960,
BBR203P930, BBR203P927,
BBR203P920, BBR203P945,
BBR203P955, BBR203P940,
BBR203P950



Vasos impacto Torx® 1/2" para frenos



BBR203P920-BBR203P960

		€		
T20	78 mm	15,47	1	BBR203P920
T25	78 mm	15,47	1	BBR203P925
T27	78 mm	15,47	1	BBR203P927

		€		
T30	78 mm	15,47	1	BBR203P930
T40	78 mm	15,47	1	BBR203P940
T45	78 mm	15,47	1	BBR203P945
T50	78 mm	15,47	1	BBR203P950
T55	78 mm	16,38	1	BBR203P955
T60	78 mm	16,38	1	BBR203P960

Juego de 6 vasos de 1/2 de impacto XZN para frenos



BBR201P6

	€		
68 x 225 x 225 mm	81,19	8	BBR201P6

BBR201P67814, BBR201P67816,
BBR201P67818, BBR201P64018,
BBR201P64014, BBR201P64016



Vasos impacto 1/2" con punta XZN



BBR201P64014-BBR201P67818

		€		
M14	40 mm	8,32	1	BBR201P64014
M16	40 mm	8,32	1	BBR201P64016
M18	40 mm	8,55	1	BBR201P64018
M14	78 mm	9,58	1	BBR201P67814
M16	78 mm	9,58	1	BBR201P67816
M18	78 mm	10,47	1	BBR201P67818

Juego de vasos de 1/2 de perfil pentagonal, para freno de mano



BBR202P4

	€		
43 x 90 x 200 mm	45,76	1	BBR202P4
	6,80	1	BBR202P410
	6,80	1	BBR202P414
	8,32	1	BBR202P419
	8,32	1	BBR202P455

3 vasos 10,14 y 19mm 1 vaso con punta 10mm

Juego para extracción e instalación de muelles de freno



BBR210P3

	€		
80 x 270 x 375 mm	155,02	1	BBR210P3
25 x 59 x 182 mm	99,37	1	BBRS210P
75 x 270 x 350 mm	113,58	1	BBRS210P2

Tenaza para muelles de freno con cabeza oscilante



BBR6135

	€		
335 mm	65,98	1	BBR6135



Alicate para muelles de freno



BBR6131

	€		
210 mm	32,88	1	BBR6131

Alicate para muelle de freno de mano



BBR204

		€		
235 mm	21,9 mm	34,84	6	BBR204

Alicate metálico para latiguillos



BBR150i

		€		
13,5 mm	10 x 52 x 165 mm	17,29	24	BBR150i

Abocinador



BBRFKM1

		€		
141 x 115 x 195 mm	1551 g	187,66	12	BBRFKM1

HERRAMIENTAS PARA RUEDAS Y TRANSMISION

Llaves en cruz



29-B/BWXW1/BWXW2

S		€		
17,19,21 mm	1/2 in	32,32	1	29-B
17,19,22 mm	1/2 in	35,01	1	BWXW1
24,27,32 mm	3/4 in	105,02	1	BWXW2
17, 19, 21, 22 mm		32,32	1	BWXW3
24, 27, 32, 38 mm		109,08	1	BWXW4

Juegos de vasos para ruedas



BWSS12P3

		€		
17, 19, 21 mm	45 x 125 x 145 mm	40,26	20	BWSS12P3

BWSS12P317, BWSS12P319, BWS-S12P321

Juego de vasos de impacto para ruedas 1/2"



BWSS12P5

		€		
17, 19, 21, 22, 24 mm	175 x 240 x 50 mm	61,94	1	BWSS12P5

BWSS12P319, BWSS12P317, BWSS12P524, BWSS12P522, BWS-S12P321

Vasos específicos para automoción



BWSS12P

		€		
1/2 in	17 mm	13,33	1	BWSS12P317
1/2 in	19 mm	14,15	1	BWSS12P319
1/2 in	21 mm	14,15	1	BWSS12P321
1/2 in	22 mm	16,15	1	BWSS12P522
1/2 in	24 mm	16,15	1	BWSS12P524

Vaso de impacto para ruedas, 15mm



BWSMB15

	€		
15 mm	14,46	25	BWSMB15

Vaso impacto 17mm para Mercedes



BWSMB17

	€		
17 mm	16,15	1	BWSMB17

Juego vasos impacto 1/2" para ruedas



BWSS12PL

		€		
1/2 in	17 mm	23,97	1	BWSS12P317L
1/2 in	19 mm	24,10	1	BWSS12P319L
1/2 in	21 mm	24,24	1	BWSS12P321L

Juego vasos para tuercas redondeadas



BWTSP6

	€		
55 x 105 x 217 mm	94,54	1	BWTSP6

Vaso de impacto antirrobo de 21 mm para Hyundai y KIA



BWSHK21

		€		
1/2" in	21 mm	16,83	25	BWSHK21

Juego de vasos largos torsión 1/2", 17, 19 y 21mm



BWTSP3L

	€		
68 x 225 x 150 mm	132,62	1	BWTSP3L

BWTSP619, BWTSP617, BWTSP622, BWTSP621, BWTSP624

Vasos para tuercas redondeadas



BWTSP617-BWTSP624

		€		
17 mm	1/2 in	18,93	1	BWTSP617
19 mm	1/2 in	18,93	1	BWTSP619
21 mm	1/2 in	18,93	1	BWTSP621
22 mm	1/2 in	19,65	1	BWTSP622
24 mm	1/2 in	19,65	1	BWTSP624

Juego vasos de impacto para ruedas 17, 19 y 21mm



BWSS12P3L

		€	
17, 19, 21 mm	68 x 225 x 225 mm	97,06	1

Vaso largo torsión 1/2" 150mm



BWTSP317L-BWTSP321L

		€		
1/2 in	17 mm	40,33	1	BWTSP317L
1/2 in	19 mm	43,76	1	BWTSP319L
1/2 in	21 mm	47,46	1	BWTSP321L

Juego de 7 vasos para ruedas



BWTSP7

	€		
52 x 117 x 207 mm	266,34	1	BWTSP7

BWSS12P317L, BWSS12P319L, BWSS12P321L

1/2": 22, 24, 27, 32 mm & 3/4": 36, 41 mm



Vasos específicos para automoción



BWTSP16

	€		
48 x 125 x 245 mm	291,59	1	BWTSP16

3/8": 8, 10, 11, 12, 13, 14, 16, 17, 18, 19 mm & 1/2": 21, 22, 24, 27 mm

Vasos para ruedas



BWTSP

		€		
8 mm	3/8 in	24,20	1	BWTSP1608
10 mm	3/8 in	15,27	1	BWTSP1610
11 mm	3/8 in	15,27	1	BWTSP1611
12 mm	3/8 in	15,27	1	BWTSP1612
13 mm	3/8 in	15,27	1	BWTSP1613
14 mm	3/8 in	15,27	1	BWTSP1614
16 mm	3/8 in	16,36	1	BWTSP1616
17 mm	3/8 in	16,36	1	BWTSP1617
18 mm	3/8 in	16,36	1	BWTSP1618
19 mm	3/8 in	16,36	1	BWTSP1619
21 mm	1/2 in	31,90	1	BWTSP1621
22 mm	1/2 in	32,24	1	BWTSP1622
24 mm	1/2 in	32,99	1	BWTSP1624
27 mm	1/2 in	33,62	1	BWTSP1627
32 mm	1/2 in	78,12	1	BWTSP732
36 mm	3/4 in	92,72	1	BWTSP736
41 mm	3/4 in	107,99	1	BWTSP741

Set 5 barras de torsión



BWTB12P5

		€		
68 x 225 x 280 mm	1.74 kg	119,84	1	BWTB12P5

BWTB12P90, BWTB12P100, BWTB12P110, BWTB12P120, BWTB12P135

Barra de torsión



BWTB12P120-BWTB12P200

	Nm	€		
200 mm	100 N-m	23,56	1	BWTB12P100
200 mm	110 N-m	23,56	1	BWTB12P110
200 mm	120 N-m	23,56	1	BWTB12P120
200 mm	135 N-m	23,56	1	BWTB12P135
200 mm	150 N-m	23,56	1	BWTB12P150
200 mm	160 N-m	23,56	1	BWTB12P160
200 mm	175 N-m	23,56	1	BWTB12P175
200 mm	190 N-m	23,56	1	BWTB12P190
200 mm	200 N-m	23,56	1	BWTB12P200
200 mm	90 N-m	23,56	1	BWTB12P90

Barra de torsión de impacto 1"



BZWTB

		€		
32 mm	450 N-m	176,49	1	BZWTB0132450
32 mm	600 N-m	176,49	1	BZWTB0132600

Bolsa para tornillos y vasos para ruedas



BWBB

		€		
0.023 kg	180 x 1 x 300 mm	8,41	200	BWBB

Juego de machos y terrajas



BWHTRS12

		€		
225 x 67 x 225 mm	1350 g	220,01	15	BWHTRS12

Una llave hexagonal para ajustar las terrajas

Desmontador de neumáticos



38-8 - 38-24

↔ L ↔	€		
200 mm	16,15	5	38-8
300 mm	20,20	5	38-12
400 mm	25,59	5	38-16
500 mm	32,32	2	38-20
600 mm	40,39	1	38-24

Desmontador de neumáticos, curvado



39-24

↔ L ↔	€		
605 mm	26,95	1	39-24

Medidor digital de profundidad de neumático



BWTGD1

↔ L ↔		€		
0 - 25 mm	30 x 76 x 156 mm	38,18	50	BWTGD1

Desmontador de neumáticos



38A

↔ L ↔	€		
200 mm	6,45	25	38A-08
240 mm	7,13	25	38A-10
304 mm	8,08	1	38A-12
382 mm	9,43	25	38A-15
537 mm	18,86	1	38A-21
655 mm	21,54	1	38A-26

Cuñas para ruedas



BWC1

	€		
75 x 77 x 110 mm	17,25	25	BWC1

Medidor de presión de neumáticos



BWTPG1

	€		
20 x 90 x 394 mm	53,32	10	BWTPG1

Desmontador de neumáticos Curvado



38C

↔ L ↔	€		
645 mm	24,24	1	38C-26

Pinza equilibrado de ruedas



BWP150

	€		
20 x 87 x 255 mm	24,24	1	BWP150

Herramientas de mantenimiento del sistema de monitorización de la presión de los neumáticos



BWTPMSS9

		€		
68 x 225 x 225 mm	1049 g	321,80	8	BWTPMSS9



Herramientas de mantenimiento del sistema de monitorización de la presión de los neumáticos



BWTVCTT355

		€		
0.45 N·m	0.33 lbf·ft	28,13	1	BWTVCTT355

Tapones de deflación de la boquilla del neumático



BWTPMSS4C

		€		
27 x 59 x 108 mm	60 g	34,34	25	BWTPMSS4C

Juego de vasos de impacto de 1/2" para tuercas de bujes



BT15P5

	€		
60 x 85 x 255 mm	81,19	1	BT15P5

2 Vasos Hex: 14 y 17mm 3 Vasos Bihex: 24, 30, 32mm

Vaso de impacto de 1/2" bihexagonales



BT15P524-BT15P536

		€		
1/2 in	24 mm	12,61	1	BT15P524
1/2 in	30 mm	15,16	1	BT15P530
1/2 in	32 mm	16,32	1	BT15P532
1/2 in	36 mm	21,76	1	BT15P536

Vasos de impacto 3/4", 8 caras



BHVIS08

		€		
3/4 in	95 mm	175,04	1	BHVIS0895
3/4 in	100 mm	193,21	1	BHVIS08100
3/4 in	115 mm	197,53	1	BHVIS08115
	109 mm	206,96	1	BHVIS109BPW12
	120 mm	240,34	1	BHVIS120BPW16

Vasos de impacto de pared fina, 1"



BHVIS12 / BHVIS06

		€		
12	68 mm	86,16	1	BHVIS1265
6	70 mm	97,62	1	BHVIS0670
6	77 mm	129,26	1	BHVIS0677
6	80 mm	137,34	1	BHVIS0680
6	85 mm	201,97	1	BHVIS0685
6	90 mm	214,08	1	BHVIS0690
6	95 mm	336,61	1	BHVIS0695
6	100 mm	504,93	1	BHVIS06100
6	105 mm	572,24	1	BHVIS06105

Vasos de impacto para BPW



BHVISxxBPW

		€		
3/4 in	111 mm	216,79	1	BHVIS111BPW12
3/4 in	80 mm	153,49	1	BHVIS80BPW12
3/4 in	95 mm	158,88	1	BHVIS95BPW9

Plato extractor de cubos de ruedas



BWHEPSSH8

		€		
12 to	#4-5/116-135 mm	968,25	1	BWHEPSSH8

Plato extractor de cubos de ruedas con husillo hidráulico



BWHEPS

		€		
12 to	#4-5/116-135 mm	457,51	1	BWHEPS

BWHEP

BWHEHS



Plato extractor de cubos de ruedas con martillo deslizante



BWHEPSH8

		€		
#4-5 / 116-135 mm	960 x 150 x 150 mm	598,30	1	BWHEPSH8

Plato extractor de bujes



BWHEP

		€		
#4-5 / 116-135 mm	90 x 147 x 147 mm	235,77	1	BWHEP

Husillo hidráulico 12Tn



BWHEHS

		€		
12 to	265-282 mm	245,76	1	BWHEHS

Avance 17mm

Martillo de inercia 5Kg



BWSH5

	€		
100 x 100 x 985 mm	342,91	2	BWSH5

Martillo de inercia 8Kg



BWSH8

	€		
960 x 100 x 100 mm	444,37	1	BWSH8

Compuesto por martillo 5Kg (BWSH5) + Adaptador M18 +Maza adicional 3Kg (BSSHE3)

BWSH5	
BWSH51	
BSSHE3	

Maza de 3Kg



BSSHE3

		€		
60 mm	100 mm	101,46	1	BSSHE3

Adaptador M18



BWSH51

		€		
M38 mm	M18x38	18,31	1	BWSH51

Kit de reparación BS52 39-52mm



BS5228-BS523945

	€		
28-34 mm	88,86	1	BS5228341
34-40 mm	88,86	1	BS5234401
39-35 mm	88,86	1	BS5239451

Kit de preparación de abrazaderas



BE2512005

		€		
5 mm	12 m	78,10	1	BE2512005



Alicate para abrazaderas



BE251200

170 mm € 99,64 1 BE251200

Herramienta para soltar y apretar rótulas axiales



BS52

110 x 315 x 380 mm 3.08 kg € 249,09 1 BS52

Vaso excéntrico de ajuste de caída para BMW



BS45BMW

1/2 in 40 x 43 x 43 mm € 35,53 20 BS45BMW

Expansor neumático de guardapolvos



BPCVB1

25-110 mm 138 x 138 x 455 mm € 226,49 6 BPCVB1

Útil para rótulas de dirección



BS54

57 x 57 x 70 mm € 64,63 1 BS54

Útil para ajuste de caída grupo VAG



BS40VAG

22 mm 52 x 92 x 150 mm € 63,95 20 BS40VAG

Kit de preparación de abrazaderas



BE2512008

8 mm 15 m € 83,48 1 BE2512008

Vaso para el extremo de la barra de acoplamiento.



BS56

1/2 in 57 x 57 x 57 mm € 35,25 6 BS56

Juego colocación/extracción de bujes y rodamientos de ruedas



BWB14

80 x 300 x 525 mm € 484,49 2 BWB14

Juego para extracción e instalación de rodamientos



BT20P26

	€		
150 x 310 x 535 mm	693,43	1	BT20P26

Juego de extractores de rótula con husillo hidráulico 12t



BWHPJ12

		€		
12 to	70 mm	304,14	4	BWHPJ12

Juego de herramientas para embrague SAC



BE301

	€		
80 x 395 x 430 mm	456,77	2	BE301

Set para extraer e instalar de cojinetes hidráulicos



BT20P49

	€		
164 x 520 x 890 mm	2.523,68	1	BT20P49

VW T4 Herramienta para reemplazo de juntas



4594VWT4

	€		
245 x 112 x 320 mm	355,90	5	4594VWT4

Juego de mandriles de centrado para embragues SAC



BE301CM-SET

	€		
26 x 81.5 x 200 mm	62,80	50	BE301CM

BE301CM-01, BE301CM-02

Extractor de rótulas, para barras y bielas de dirección



BS6

		€		
18 mm	400 mm	53,87	1	BS618
23 mm	400 mm	105,28	1	BS623

Vaso extractor de rótulas grupo PSA



BS100PSA1

		€		
56 mm	52 mm	101,56	1	BS100PSA1

Mandriles de centrado para embragues SAC



BE301CM

		€		
15.19 mm	174 mm	32,35	20	BE301CM-01
20.26 mm	174 mm	32,35	20	BE301CM-02



Centrador de embragues



BE310

		€		
68 x 225 x 280 mm	1.14 kg	80,79	8	BE310

	€		
42 x 160 x 160 mm	82,72	1	BS15160
42 x 160 x 170 mm	6,87	1	BS15160C
42 x 160 x 212 mm	88,15	1	BS15212
24 x 160 x 215 mm	6,87	1	BS15212C
45 x 56 x 95 mm	44,66	1	BS1550

Desmontador neumático de amortiguadores



BS30PG

		€		
1180 x 500 x 625 mm	24 kN	2.474,20	1	BS30PG

Extensión de altura móvil



BS30AC1

	€		
336 x 545 x 450 mm	479,34	1	BS30AC1

Juego universal extractor de copelas de suspensión



BS1000

	€		
70 x 405 x 575 mm	390,48	1	BS1000
	17,76	1	BS100001
	17,76	1	BS100002
	17,76	1	BS100003
	17,76	1	BS100004
	17,76	1	BS100005
	17,76	1	BS100006
	17,76	1	BS100007
	17,76	1	BS100008
	17,76	1	BS100009
	14,52	1	BS100010
	14,52	1	BS100011
	14,52	1	BS100012
	12,09	1	BS100013
	12,09	1	BS100014
	12,09	1	BS100015
	12,09	1	BS100016
	12,09	1	BS100017
	12,09	1	BS100018
	12,09	1	BS100019
	12,09	1	BS100020
	12,09	1	BS100021
	14,52	1	BS100022
	14,52	1	BS100023
	14,52	1	BS100024
	14,52	1	BS100025
	14,52	1	BS100026

HERRAMIENTAS Y EQUIPOS PARA SUSPENSIÓN

Util para brazo de suspensión



BS25

		€		
20 N·m	200 kg	227,77	1	BS25

Plato/Adaptador para amortiguadores de vehículos deportivos con anilla de regulación



BS10AC2

		€		
400 x 400 x 200 mm	1 kg	592,45	1	BS10AC2

Compresor de muelles para Macpherson



BS15

	€		
125 x 425 x 510 mm	666,50	1	BS15
43 x 110 x 160 mm	77,34	1	BS15125
165 x 160 x 385 mm	6,87	1	BS15125C

€			
14,52	1	BS100027	
14,52	1	BS100028	
12,09	1	BS100029	
12,09	1	BS100030	
12,09	1	BS100031	
12,09	1	BS100032	
12,09	1	BS100033	
12,09	1	BS100034	
16,23	1	BS100035	
16,23	1	BS100036	
16,23	1	BS100037	
16,23	1	BS100038	
16,23	1	BS100039	

Arrancador de baterías de 12/24 V 2400 / 1200 CA



BBAGM1224-2400

V	CA	€		
12 / 24 V	2400 / 1200 A	1.261,75	1	BBAGM1224-2400

Cable de carga de repuesto para arrancador de 12 V



BBAGMCAB

V	€		
25 x 80 x 200 mm 12 V	20,09	1	BBAGMCAB

HERRAMIENTAS PARA BATERÍAS Y SISTEMAS ELÉCTRICOS

Protector de memorias toma OBDII



BELMS12OBDL

€		
72,34	8	BELMS12OBDL

Batería de repuesto para arrancadores de 12 V



BBAGMBAT

V	CA	€		
12 V	25 A-h	380,07	1	BBAGMBAT

Booster para industria pesada, 12/24V



BBA1224-3200

V	CA	€		
12/24 V	3200/1600 A	3.336,29	1	BBA1224-3200

Arrancador de baterías de 12 V 1200 CA



BBAGM12-1200

V	CA	€		
12 V	1200 A	556,20	1	BBAGM12-1200

Cargadores electrónicos automáticos para arrancadores



BBAGMCHG

€		
96,82	1	BBAGMCHG

Booster de condensadores híbrido 12V



BBH12-1200

V	CA	€		
12 V	1200 A	908,96	1	BBH12-1200



Cables de arranque para baterías



BBJL

Diagram	L	€	Icons	Model
	3 m	41,13	5	BBJL1630
	3.5 m	95,52	1	BBJL2535
	4.5 m	127,09	1	BBJL3545

Cargador baterías 12V



BBCE12-10

V	A	€	Icons	Model
12 V	10 A	145,92	2	BBCE12-10

Cargador de batería 100A



BBCE12-F100

V	A	€	Icons	Model
12 V	4/20/70/100AA	1.406,14	1	BBCE12-F100

Cargador baterías eléctrico 12V-3 A



BBCE12-3

V	A	€	Icons	Model
12 V	3 A	99,50	2	BBCE12-3

Cargador mantenedor automático 15 amps para baterías de 12V con Función Showroom



BBCE12-15S

V	A	€	Icons	Model
12 V	10/15 A	177,30	2	BBCE12-15S

Cargador-arrancador de baterías 12/24V



BBC420-BBC620

V	Capacity	€	Icons	Model
230 V	20/1000 A·h	583,69	1	BBC420
230 V	20/1550 A·h	835,73	1	BBC620

Cargador baterías eléctrico 12V-6A



BBCE12-6

V	A	€	Icons	Model
12 V	6 A	119,39	2	BBCE12-6

Cargador baterías eléctrico 24V-10A



BBCE24-10

V	A	€	Icons	Model
24 V	10 A	198,99	2	BBCE24-10

Densímetro para baterías



BB10

Dimensions	€	Icons	Model
50 x 50 x 285 mm	12,18	1	BB10

Tester digital baterías 12 V



BBT20

	€		
90 x 160 x 345 mm	98,17	1	BBT20

Multimetro



BMMTRMS1

		€		
155 x 60 x 225 mm	0.8 kg	214,26	1	BMMTRMS1

Comprobador de mandos de distancia



BELTKEY

	€		
35 x 63 x 160 mm	177,73	1	BELTKEY

Comprobador de baterías digital de 12V



BBT60A

	€		
27 x 95 x 135 mm	215,22	36	BBT60A

Comprobador de ausencia de tensión de 1000 V, comprobador de tensión sin contacto



BMVAT1000

		€		
310 x 50 x 100 mm	0.302 kg	135,91	50	BMVAT1000

Comprobador toma de remolque 7 polos 12V



BELT127

	€		
35 x 63 x 160 mm	106,37	1	BELT127

Comprobador electrónico de baterías con impresora 6-12V



BBT80

	€		
64 x 130 x 251 mm	608,90	6	BBT80

Pinza amperimétrica digital True RMS 1000 A CA/CC



BDACM1000

		€		
60 x 143 x 250 mm	0.551 kg	124,65	30	BDACM1000

Comprobador eléctrico de funcionamiento de lámparas de vehículo de 12 V



BELT1213A

		€		
40 x 138 x 205 mm	1.726 kg	309,74	20	BELT1213A



Comprobador eléctrico de funcionamiento de lámparas de vehículo de 24V



BELT2415A

40 x 138 x 205 mm 1.897 kg 360,75 20 BELT2415A

Soldador de gas profesional



BGIS125

25-125 W 46 x 88 x 295 mm 166,95 20 BGIS125

Funda protectora

Juego universal de útiles para terminales, 16 piezas



BELTRP16

58 x 215 x 265 mm 215,43 1 BELTRP16
 22,65 1 BELTRP1601
 2,15 1 BELTRP1602
 23,80 1 BELTRP1603
 2,15 1 BELTRP1604
 22,65 1 BELTRP1605
 2,15 1 BELTRP1606
 21,24 1 BELTRP1607
 22,65 1 BELTRP1608
 17,94 1 BELTRP1609
 19,87 1 BELTRP1610
 22,10 1 BELTRP1611
 23,11 1 BELTRP1612
 15,15 1 BELTRP1613
 17,92 1 BELTRP1614
 17,92 1 BELTRP1615
 17,92 1 BELTRP1616

Protector de picos de 12 & 24V



BELP1224

35 x 63 x 160 mm 87,53 1 BELP1224

Comprobador toma remolque 7 polos 24V



BELT247N

55 x 63 x 160 mm 115,80 1 BELT247N

Pinzas para baterías (conexión rápida) para cargadores BBCE12-10 y BBCE24-10



BBCEC1

68 g 9,82 1 BBCEC1

Comprobador toma de remolque 7 polos 24 V (24S)



BELT247S

35 x 63 x 155 mm 115,80 1 BELT247S

Protector de memorias 12V



BELS12

35 x 63 x 160 mm 92,91 1 BELS12

Conector de terminales (conexión rápida) para cargadores BBCE612-2, BBCE12-3 y BBCE12-6



BBCER1

100 g 9,95 1 BBCER1

Pinzas para baterías (conexión rápida) para cargadores BBCE612-2, BBCE12-3 y BBCE12-6



BBCEC2

	€		
68 g	13,21	1	BBCEC2

Conector de terminales (conexión rápida) para cargadores BBCE12-10 y BBCE24-10



BBCER2

	€		
100 g	13,21	1	BBCER2

Cables para cargadores de arrancadores:



BBBCAB

	€		
50 x 125 x 50 mm	11,82	1	BBBCAB-AUZ
50 x 125 x 50 mm	14,01	1	BBBCAB-EU
50 x 50 x 50 mm	11,82	1	BBBCAB-UK

PRENSAS Y ACCESORIOS

Presna de sobremesa 15T



BH715

	€		
15.000 kg	1.027,43	1	BH715

Presna Hidráulica con bomba doble velocidad

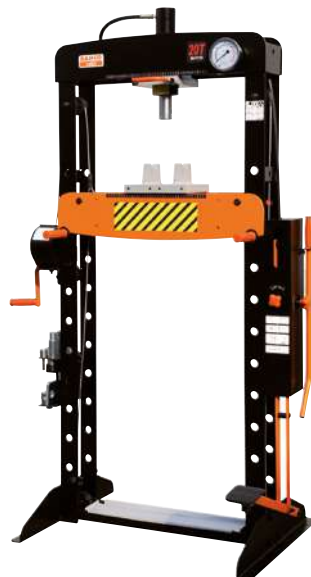

BH720/BH730/BH750

	€		
20.000 kg	1.885,18	1	BH720
30.000 kg	2.207,09	1	BH730
50.000 kg	3.242,38	1	BH750

8 mandrinos presión incluidos Pasadores de fijación de mesa autocentrantes

Presna pistón deslizante y c/pedal 100Tn



BH7100

	€		
100000 kg	7.713,24	1	BH7100A

Soportes universales para prensas (30 T)



BH7PS30

	€		
225 x 100 x 275 mm	313,64	2	BH7PS30

Juego de mandrinos para prensas 15T



BH715-13

	€		
7.09 kg	148,10	1	BH715-13
7.09 kg	161,54	1	BH720-22



Panel de seguridad para prensas

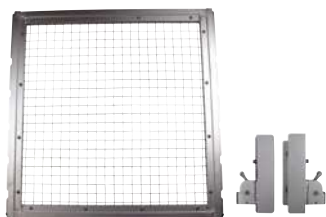

BH7 SG

Altura	Profundidad	Peso	Cant.	Modelo
530 mm	20 mm	150,31	1	BH720SG
590 mm	20 mm	163,99	1	BH730SG
625 mm	20 mm	177,65	1	BH750SG

Bandeja inferior para mesa multiusos



BLEMAT1BT

Dimensiones	Peso	Precio	Cant.	Modelo
50 x 760 x 890 mm	10.5 kg	86,39	1	BLEMAT1BT

Plato magnético de 1500mm



BMD150

Diámetro	Precio	Cant.	Modelo
160 mm	12,78	1	BMD150

Rejilla de seguridad para prensa de 100T



BH7100SG

Dimensiones	Peso	Precio	Cant.	Modelo
150 x 593 x 625 mm	5.54 kg	450,68	1	BH7100SG

Juego de 4 bolsas protectoras para ruedas y llantas



BWB1418S4/BWB1922S4

Diámetro	Peso	Cant.	Modelo
355 - 470 mm	72,97	6	BWB1418S4
470 - 560 mm	82,25	6	BWB1922S4

Bandeja magnética con solapa PVC



BMR240

Longitud	Precio	Cant.	Modelo
250 mm	22,90	1	BMR240

EQUIPAMIENTO LIGERO

Mesas multiusos



BLEMAT1

Dimensiones	Peso	Precio	Cant.	Modelo
860 x 155 x 780 mm	28.7 kg	435,38	1	BLEMAT1

Plato magnético



1419-MD

Diámetro	Peso	Cant.	Modelo
150 mm	11,98	1	1419-MD

Taburete altura ajustable



BLE305

Dimensiones	Peso	Cant.	Modelo
430 x 410 x 430 mm	152,56	1	BLE305

Taburete para taller con altura regulable



BLE300

		€		
380 x 380 x 550 mm	136 kg	187,16	1	BLE300

Conjunto camilla y taburete



BLE304

		€		
460 x 1020 x 135 mm	116 / 100 kg	166,96	1	BLE304

Panel protector para vehiculos



BBS50

		€		
900 mm	1.2 mm	55,06	1	BBS50

Combi Camilla y Asiento



BLE302

		€		
135 x 490 x 1010 mm	136 kg	123,65	1	BLE302

Capacidad 135kg

Cubre asientos de nylon de gran resistencia



5750

	€		
1390 mm	18,30	1	5750

Fácilmente lavable

Centrafaros laser dual



BLBT100

	€		
1650 x 500 x 565 mm	1.205,08	1	BLBT100

Camilla de perfil bajo 120mm



BLE301

		€		
120 x 590 x 1020 mm	136 kg	117,15	1	BLE301

Capacidad 135 Kg

Protector frontal para vehiculos



5770

		€		
350 x 300 x 85 mm	990 g	73,81	12	5770

Riel para BLBT100



BLBT100AC1

		€		
150 x 150 x 1025 mm	7.77 kg	312,45	1	BLBT100AC1



Juego de tres palancas articuladas



BT10P3

	€		
--	---	--	--

80 x 270 x 375 mm 123,86 1 BT10P3

250mm (BT10P325); 300mm(BT10P330) 380mm (BT10P338)

Palanca articulada



BT10P325-BT10P338

	€		
--	---	--	--

250 mm 40,92 40 BT10P325
 300 mm 44,71 1 BT10P330
 380 mm 51,00 1 BT10P338

La cabeza se puede ajustar en 14 posiciones

Set de palancas multiusos largas



BPBLS4

		€		
--	--	---	--	--

78 x 255 x 1000 mm 9050 g 237,49 2 BPBLS4

BPBL00900, BPBL30900, BPBL70600, BPBL90600

Palanca multiusos



BPBL

	€		
--	---	--	--

930 mm 64,39 5 BPBL00900
 925 mm 64,39 5 BPBL30900
 610 mm 56,62 5 BPBL70600
 628 mm 57,59 5 BPBL90600

HERRAMIENTAS PARA CARROCERÍA

Soporte universal con ventosas para lunas



BBS3BH1

	€		
--	---	--	--

955 mm 114,46 1 BBS3BH1

Ventosa para soporte universal



BBS3BH1-VP

	€		
--	---	--	--

60 x 95 x 95 mm 16,18 40 BBS3BH1-VP

Soporte para piezas de carrocería



BBS3UH

		€		
--	--	---	--	--

950 x 800 x 1200 mm 20 kg 462,55 1 BBS3UH

2 ruedas fijas 2 giratorias 360° con sistema bloqueo

Ventosa para capacidad 75Kg.



BBS075

		€		
--	--	---	--	--

160 mm 175 mm 40,52 12 BBS075

Ventosas dobles y correa tensora



BBS150

		€		
--	--	---	--	--

120 mm 400 mm 129,26 1 BBS150

Limpiador de canal de parabrisas



BBS106

		€		
25 x 25 x 332 mm	0.145 kg	19,73	1	BBS106

Tirador con mango de alambre cortajuntas



BBS103

	€		
25 x 25 x 345 mm	20,20	1	BBS103

Tirador mango en T de alambre cortajuntas



BBS102

	€		
265 mm	12,38	1	BBS102

Pareja de empuñaduras para alambre cortajuntas de parabrisas



BBS101

	€		
30 x 80 x 115 mm	30,97	1	BBS101

Cable para cortajuntas de parabrisas 50m



BBS150S

	€		
50 m	49,82	1	BBS150R
50 m	57,90	1	BBS150S
50 m	63,29	1	BBS150T

Cortajuntas BBS101

Útil cortajuntas parabrisas



BBS105

	€		
20 x 90 x 200 mm	40,39	1	BBS105

Incluye hoja L 25mm

Cuchillo de uretano para lunas / parabrisas



BBS10450

		€		
10 x 30 x 450 mm	0.240 kg	28,01	1	BBS10450

Cuchilla trapezoidal de cutter estándar

Juego de tres cuchillas rectas en blíster



BBS107

	€		
1 x 18 x 125 mm	10,72	1	BBS107

Medidas: 19, 25, 38mm

Juego de tres cuchillas en 'L'



BBS108

	€		
20 x 19 x 88 mm	10,72	1	BBS108

Presentadas en blíster

Juego Extractor Limpiaparabrisas Univ.



BBS165

	€		
117 x 25 x 78 mm	114,46	10	BBS165



Juego de extractores para brazos de limpiaparabrisas



BBS170P13

	€		
--	---	--	--

80 x 275 x 375 mm	212,74	1	BBS170P13
	10,97	1	BBS170P131
	10,97	1	BBS170P132
	10,97	1	BBS170P133
	10,97	1	BBS170P134
	10,97	1	BBS170P135
	10,97	1	BBS170P136
	10,97	1	BBS170P137
	12,72	1	BBS170P138
	13,56	1	BBS170P139
	16,99	50	BBS165SP4

Enderezador a inercia para carrocerías 12Kg



BBS12SH

	€		
--	---	--	--

800 mm	12 kg	435,81	1	BBS12SH
--------	-------	---------------	---	---------

Longitud 800mm

Martillo carrocerero cabeza plana lisa



BBSH1F

	€		
--	---	--	--

50x30 mm	43,57	1	BBSH1F
----------	--------------	---	--------

Mango de hickory

Martillo carrocerero cabeza cuadrillada



BBSH1M

	€		
--	---	--	--

50x30 mm	61,20	1	BBSH1M
----------	--------------	---	--------

Mango de hickory

Martillo carrocerero cabeza redonda plana



BBSH2F

	€		
--	---	--	--

40 mm	44,44	6	BBSH2F
-------	--------------	---	--------

Mango hickory

Martillo carrocerero cara redonda convexa



BBSH2C

	€		
--	---	--	--

40 mm	44,44	1	BBSH2C
-------	--------------	---	--------

Mango hickory genuino

Martillo para carrocerero



BBSH3CF

		€		
--	--	---	--	--

40 mm	37 mm	45,46	6	BBSH3CF
-------	-------	--------------	---	---------

F - Cuadrada plana C - Abombada lisa

Martillo carrocerero cara redonda convexa y otra rectángulo angulado



BBSH2CA

	€		
--	---	--	--

40 mm	49,82	12	BBSH2CA
-------	--------------	----	---------

Una cara redonda Convexa (C) Otra cara rectángulo angulado

Martillo para carrocerero ligero



BBSH3CF30

		€		
--	--	---	--	--

30 mm	25 mm	48,35	6	BBSH3CF30
-------	-------	--------------	---	-----------

Cuadrada (F) Redonda abombada (C)

Martillo carrocerero cabeza plana lisa



BBSH2CP

	€		
--	---	--	--

40 mm	45,13	6	BBSH2CP
-------	--------------	---	---------

Cabeza redonda (C) abombada y lisa

Martillo carrocerero ligero cabeza cuadrillada, redonda plana y lista



BBSH3FS

		€		
--	--	---	--	--

37 mm	40 mm	48,44	6	BBSH3FS
-------	-------	--------------	---	---------

Cabeza cuadrada dentada (SM) redonda plana y lisa (F)

Martillo carrotero cara redonda dentada y cuadrada plana



BBSH3MF

		€		
30 mm	27 mm	47,18	1	BBSH3MF

Mango repuesto para martillo BBSH



BBSHWH1

	€		
160 g	15,48	1	BBSHWH1

Tas americano



BBSDA

	€		
30 x 63 x 83 mm	58,16	1	BBSDA

Tas coma



BBSDC

	€		
40 x 58 x 128 mm	60,42	6	BBSDC

Tas diábolo



BBSDD

	€		
55 x 55 x 55 mm	45,76	1	BBSDD

Tas Tacón



BBSDH

	€		
30 x 60 x 79 mm	54,03	1	BBSDH

Tas americano ligero



BBSDT

	€		
26 x 58 x 120 mm	65,73	6	BBSDT

Tas de cuña



BBSDW

	€		
25 x 64 x 112 mm	45,23	6	BBSDW

Tas de caucho para carrotero



BBSDHR

	€		
40 x 62 x 75 mm	24,13	1	BBSDHR

Núcleo de acero con recubrimiento de goma

Cuchara para carrotero



BBSS1

	€		
25 x 56 x 390 mm	103,77	1	BBSS1

Palanca para carrotero



BBSS2

	€		
150 x 60 x 410 mm	112,94	8	BBSS2

Palanca pesada para carrotero



BBSS2L

		€		
175 x 60 x 520 mm	2.3 kg	118,14	1	BBSS2L



Leva para clip de guarnecidos



2485

	€		
240 mm	9,31	1	2485

Pinza para tapicería de puertas



BBS200

	€		
65 x 75 x 250 mm	43,09	1	BBS200

Juego de útiles para interiores universal, 12pzs



BBS20P12

	€		
35 x 355 x 585 mm	61,94	1	BBS20P12

Equipo reparador de plásticos



BBS210

	€		
100 x 280 x 360 mm	399,91	1	BBS210
22 x 64 x 106 mm	24,01	1	BBS210U06
22 x 64 x 106 mm	26,15	1	BBS210U08
22 x 64 x 106 mm	29,09	1	BBS210UA06
22 x 64 x 106 mm	32,02	1	BBS210UA08
22 x 64 x 106 mm	24,01	1	BBS210V06
22 x 64 x 106 mm	26,15	1	BBS210V08
22 x 64 x 106 mm	31,30	1	BBS210W06
22 x 64 x 106 mm	34,18	1	BBS210W08

Juego herramientas universal para extracción de Air bags, 12 PZs



BBS100

	€		
55 x 160 x 275 mm	75,40	1	BBS100
	7,55	1	BBS10001
	13,33	1	BBS10002
	9,07	1	BBS10003
	20,84	1	BBS10004
	5,01	1	BBS10005
	2,18	1	BBS100057
	3,48	1	BBS10006
	3,35	1	BBS10007
	3,48	1	BBS10008
	3,35	1	BBS10009
	3,35	1	BBS10010

Juego de 4 espátulas



2220

	€		
125 g	19,27	1	22209004B

Remachadora para tuercas M3-M6



1468-M6

	€		
20 x 110 x 265 mm	102,22	1	1468-M6

Juego: 1468-M6

Remachadora para tuercas M4-M10



1468-M10

	€		
50 x 210 x 575 mm	256,78	6	1468-M10

Insertos para remachadora para tuercas 1468-M6



1468-6M

Icon	€	Icon	Icon
15 x 15 x 50 mm	5,02	1	1468-6M3
13 x 13 x 50 mm	5,02	1	1468-6M4
25 x 25 x 55 mm	5,02	1	1468-6M5
20 x 20 x 55 mm	5,02	1	1468-6M6

Insertos para remachadora para tuercas 1468-M10



1468-10M

Icon	€	Icon	Icon
17 x 17 x 90 mm	19,65	1	1468-10M4
17 x 17 x 90 mm	19,65	1	1468-10M5
20 x 20 x 90 mm	19,65	1	1468-10M6
20 x 20 x 85 mm	19,65	1	1468-10M8
20 x 20 x 85 mm	19,65	1	1468-10M10

Juego portátil para carroceros



BH8PR

Icon	kg	€	Icon	Icon
220 x 480 x 1030 mm	31 kg	397,21	1	BH8PR10000
168 x 345 x 575 mm	18.65 kg	264,91	1	BH8PR4000

Abrazadera para carroceros



BH8BC1

Icon	€	Icon	Icon
45 x 135 x 230 mm	115,10	1	BH8BC1

Abrazadera para carroceros



BH8BC2

Icon	€	Icon	Icon
51 x 150 x 220 mm	137,56	1	BH8BC2

Abrazadera para carroceros



BH8BC3

Icon	€	Icon	Icon
90 x 65 x 240 mm	108,76	10	BH8BC3

Abrazadera para carroceros



BH8BC4

Icon	€	Icon	Icon
80 x 120 x 175 mm	233,82	6	BH8BC4

Abrazadera para carroceros



BH8BC5

Icon	€	Icon	Icon
45 x 155 x 230 mm	161,52	6	BH8BC5

EQUIPOS DE ELEVACIÓN

Gato de botella con base soldada



BH4S

Icon	Icon	€	Icon	Icon
2000 kg	180 x 83 x 93 mm	34,61	6	BH4S2
4000 kg	190 x 91 x 100 mm	54,08	6	BH4S4
6000 kg	215 x 96 x 114 mm	64,89	4	BH4S6
8000 kg	230 x 103 x 120 mm	77,87	4	BH4S8
12000 kg	235 x 117 x 135 mm	84,36	3	BH4S12
20000 kg	240 x 145 x 153 mm	129,78	1	BH4S20
50000 kg	240 x 315 x 220 mm	281,19	1	BH4S50



Gatos de botella con base soldada



BH4

Capacidad	Dimensiones (mm)	Peso (€)	Paquetes	Accesorios
2000 kg	180 x 103 x 103 mm	86,52	1	BH42
5000 kg	210 x 110 x 110 mm	108,15	1	BH45
10000 kg	220 x 124 x 128 mm	140,60	1	BH410
15000 kg	235 x 140 x 140 mm	173,04	2	BH415
20000 kg	240 x 165 x 160 mm	205,49	1	BH420
30000 kg	245 x 185 x 175 mm	259,56	2	BH430

Gato de aluminio 2,5T



BH1A2500A

Capacidad	Dimensiones (mm)	Peso (€)	Paquetes	Accesorios
2500 kg	205 x 385 x 800 mm	565,08	1	BH1A2500A

Gato extra bajo 1,5 Tn



BH11500

Capacidad	Dimensiones (mm)	Peso (€)	Paquetes	Accesorios
1500 kg	1270 x 364 x 945 mm	579,46	1	BH11500

Gato de botella hidráulico-neumático



BH4HP50

Capacidad	Dimensiones (mm)	Peso (€)	Paquetes	Accesorios
50000 kg	300 x 210 x 310 mm	713,79	1	BH4HP50

Gato con doble pistón 3Tn



BH1EU3000

Capacidad	Dimensiones (mm)	Peso (€)	Paquetes	Accesorios
3000 kg	1400 x 340 x 617 mm	254,95	1	BH1EU3000

Gato de carretilla extra bajo 2 Tn



BH12000

Capacidad	Dimensiones (mm)	Peso (€)	Paquetes	Accesorios
2000 kg	1270 x 364 x 780 mm	515,08	1	BH12000

Gato de aluminio 1,5T



BH1A1500A

Capacidad	Dimensiones (mm)	Peso (€)	Paquetes	Accesorios
1500 kg	170 x 370 x 660 mm	368,79	1	BH1A1500A

Gato carretilla multifunción 1Tn



BH1M1000

Capacidad	Dimensiones (mm)	Peso (€)	Paquetes	Accesorios
1000 kg	1280 x 478 x 700 mm	862,74	1	BH1M1000

Gato compacto 3 Tn



BH13000

Capacidad	Dimensiones (mm)	Peso (€)	Paquetes	Accesorios
3000 kg	1280 x 364 x 825 mm	396,61	1	BH13000

Gato con aproximación rápida 3Tn



BH13000QA

		€		
3000 kg	220 x 395 x 900 mm	582,96	1	BH13000QA

Gato Hidráulico 5T



BH15000B

		€		
5000 kg	330 x 520 x 1670 mm	1.055,75	1	BH15000B

Gato tijera 4-5Tn



BH1S45

		€		
4000 kg	1194 x 212 x 680 mm	746,86	1	BH1S45

Travesía para gato de carretilla 1Tn



BH1CB1000

		€		
1000 kg	145 x 125 x 710 mm	179,01	1	BH1CB1000

Compatible con BH1M1000, BH11500, BH1200 y BH13000

Gato Hidráulico 10T



BH110000B

		€		
10000 kg	270 x 520 x 1670 mm	1.581,05	1	BH110000B

Pedal goma repuesto



BH1RS

	€		
BH1A1500A	10,28	40	BH1A1500A-05
BH1EU3000	6,81	1	BH1EU3000-03
BH11500, BH12000, BH13000, BH13000QA, BH13000L, BH1M1000, BH1A2500A	6,63	1	BH11500-04
BH15000A	4,62	1	BH15000A-04
BH110000A	12,23	1	BH110000A-04

Gato largo alta elevación 3Tn



BH13000L

		€		
3000 kg	1310 x 530 x 1370 mm	1.249,05	1	BH13000L

Extensiones de 120mm para gatos BH15000A y BH110000A



BH15000A-EXT/BH110000A-EXT

	€		
108 mm	102,75	1	BH15000A-EXT
151 mm	138,73	1	BH110000A-EXT

Ruedas delanteras de repuesto



BH1 FW

	€		
BH1A2500	77,84	1	BH1A2500-03
BH13000	22,57	1	BH13000-02
BH1EU3000	13,64	1	BH1EU3000-01
BH1M1000, BH11500, BH12000	17,73	1	BH11500-02
BH1S45	10,90	1	BH1S45-03
BH15000A	57,82	1	BH15000A-02
BH110000A	104,98	1	BH110000A-02



Gato neumático 2 niveles



BH9BJ22SSH

		€		
2000 kg	345 x 265 x 265 mm	733,97	1	BH9BJ22SSH

Gato neumático de 2 niveles



BH9BJ22

		€		
2000 kg	1000 x 265 x 265 mm	753,25	1	BH9BJ22SLH

Incluida extensión de 60mm. BH9BJ22SLH tiene mango L, BH9BJ22SSH tiene mango S

Gato Neumático 3 Niveles



BH9BJ23SSH

		€		
2000 kg	490 x 250 x 250 mm	992,20	1	BH9BJ23SSH

Gato neumático 3 niveles



BH9BJ23

		€		
2000 kg	1000 x 250 x 250 mm	1.011,51	1	BH9BJ23SLH

Incluida extensión de 60mm, BH9BJ23SLH tiene mango L, BH9BJ23SSH tiene mango S

Extensión de acero para gatos neumáticos



BH9BJ260_80

	€		
970 g	35,84	1	BH9BJ260
1180 g	41,57	1	BH9BJ280

Gato oleoneumático 30Tn



BH230

		€		
360 mm	627 mm	3.347,99	1	BH230

Gato oleoneumático compacto 30/15 Tn



BH23015C

		€		
30000 kg	1350 x 290 x 430 mm	1.673,99	1	BH23015C

Gato oleoneumático 30 / 15 T



BH23015

		€		
30000 kg	1250 x 282 x 810 mm	2.685,25	1	BH23015

Gato oleoneumático 40/20/10 Tn



BH2402010

		€		
40000 kg	1225 x 302 x 825 mm	2.304,96	1	BH2402010

Gato oleoneumático 60/40/20 t



BH2604020

		€		
60000 kg	1250 x 295 x 875 mm	3.154,83	1	BH2604020

Par de caballetes ligeros aluminio 2,5Tn



BH3AL2500

	€		
2500 kg	151,95	1	BH3AL2500

Caballote de base cuadrada



BH3SQ

	€		
7000 kg	123,81	2	BH3SQ7000
15000 kg	247,61	2	BH3SQ15000

Gato hidráulico-neumático 80/50T



BH28050

		€		
80000 kg	380 x 470 x 1200 mm	3.743,34	1	BH28050

Pareja de caballetes



BH33000/BH36000

	€		
3000 kg	64,89	1	BH33000
6000 kg	127,62	1	BH36000

Caballote para vehículo industrial



BH3HD8000

	€		
8000 kg	124,17	2	BH3HD8000

Perno de seguridad (BH3HD1200) equipado con un sistema de tirador

Set adaptadores



BH2AC

		€		
67 mm	45-75 mm	55,96	1	BH2AC1
75 mm	45-75 mm	77,84	1	BH2AC2

Pareja de caballetes automáticos



BH3A

	€		
3000 kg	108,15	1	BH3A3000
5000 kg	162,23	1	BH3A5000
10000 kg	289,34	1	BH3A10000

Caballote para vehículos 12T 1P



BH3HD12000

	€		
12000 kg	219,11	1	BH3HD12000



Caballete para vehículos 16T 1P



BH3HD16000

	€		
16000 kg	262,90	1	BH3HD16000

Gato de foso doble pistón 1000 Kg



BH5DP1000QA

		€	
1000 kg	1954 x 759 x 759 mm	925,85	1 BH5DP1000QA

Soporte para carretillas transportadoras



BH1CD680ST

		€	
715 x 130 x 155 mm	135 kg	97,34	1 BH1CD680ST

Caballete 20T para tareas pesadas



BH3HD20000A

	€	
20000 kg	315,61	1 BH3HD20000A

Cabeza giroscópica para gatos de foso



BH5US1000

		€	
250 x 340 x 420 mm	260-510 mm	236,42	1 BH5US1000

Gato hidráulico sacarruedas para camión



BH8AC3-600

		€	
1030 x 1050 x 1020 mm	93.5 kg	973,35	1 BH8AC3-600

Gato de foso doble pistón 500Kg



BH5SP500QA

		€	
500 kg	2041 x 660 x 660 mm	499,11	1 BH5SP500QA

Carretilla transportadora



BH1CD680

		€	
16.22 kg	610 x 240 x 220 mm	198,30	1 BH1CD680

Plataforma rodante, 1,5 T



BH8AC3-1500A

		€	
310 x 1070 x 1345 mm	132 kg	1.879,75	1 BH8AC3-1500A

Grúa plegable 600Kg



BH6PC600

		€		
2315 x 1040 x 1480 mm	96 kg	1.004,39	1	BH6PC600

Grúa plegable 2Tn



BH6FC2000

		€		
2640 x 1220 x 1845 mm	170 kg	1.339,19	1	BH6FC2000

Altura entrada mínima: 130mm Altura máx de gancho: 2.640mm

Bote de aceite de repuesto hidráulico ISO VG15 de 250 ml



BHVG15-250

		€		
160 x 60 x 60 mm	220 g	9,88	1	BHVG15-250

Grúa plegable 1Tn



BH6FC1000

		€		
2175 x 1030 x 1480 mm	85 kg	832,76	1	BH6FC1000

Barra soporte para motores



BH6AC1-680A

	€		
565 x 12 x 774 mm	116,80	1	BH6AC1-680A

Ruedas traseras de repuesto



BH1_RW

	€		
BH1A1500	33,57	1	BH1A1500-04
BH1A2500	59,32	1	BH1A2500-04
BH1M1000,BH11500,BH12000, BH13000	25,19	1	BH11500-01
BH1EU3000	24,14	1	BH1EU3000-08
BH13000L	16,90	1	BH13000L-01
BH1S45-01	22,97	1	BH1S45-01
BH15000A,BH110000A	27,18	1	BH15000A-01





BAHCO



Equipos de iluminación



LINTERNAS MANUALES

Lámpara-linterna con USB



BLTS7P

	€		
45 lm	56,38	58	BLTS7P

IP 20

Lámpara-linterna compacta y ligera con Aluminio



BLTFC1

	€		
180 lm	95,01	20	BLTFC1

IP 20 - Ángulo difusión 120° Batería Li-on

Lámpara-linterna ultra ligera con mini USB



BLTS10

	€		
400 lm	62,00	20	BLTS10

LINTERNAS PARA LA CABEZA

Lámpara de cabeza



BFRL11

	€		
260 lm	60,78	1	BFRL11

ENROLLADORES DE CABLE

Enrollador de cable para trabajos a 230V



BLCR230

		€		
230 V	800/2000 W	254,92	1	BLCR230FR
230 V	800/2000 W	254,92	1	BLCR230SC

Adaptador de control de velocidad BLCRSC1 opcional

Lámpara de taller con carrete enrollador 24V con transformador



BLCR24V

		€		
230/24 V	60 W	436,99	1	BLCR24VCL
230/24 V	60 W	589,58	1	BLCR24VLL

Adaptador de control de velocidad opcional BLCRSC2

Enrollador de cable 400V



BLCR400E

		€		
400 V	2800/5000 W	902,97	1	BLCR400E

15m IP24

Adaptador de control de velocidad para el enrollador cable



BLCRSC

BLCR		€		
230PL,FR,SC 76 x 91 x 117 mm		94,79	1	BLCRSC1
24VCL,VLL 76 x 91 x 117 mm		94,79	1	BLCRSC2



Herramientas de inspección



ENDOSCOPIOS

Videoscopio



BE210

Dimensions	Weight (kg)	Price (€)	Accessories
5 x 50 x 56 mm	0.04 kg	69,95	1 ZHVIDEOBAT
40 x 44 x 75 mm	0.17 kg	28,56	1 ZHVIDEOCHA

Cables lente



BE200C

Length (m)	Price (€)	Accessories
25 mm	2.526,98	1 BE200CAB250SH10
25 mm	3.497,70	1 BE200CAB250SH25
25 mm	1.684,68	1 BE200CAB250SH3
4 mm	1.099,04	1 BE200CAB40F1
5.5 mm	770,13	1 BE200CAB55F1
5.5 mm	1.018,83	1 BE200CAB55F3
5.8 mm	786,19	1 BE200CAB58SR1
5.8 mm	1.042,90	1 BE200CAB58SR3
8 mm	410,50	1 BE200CAB80SR1
8 mm	788,05	1 BE200CAB80SR3

Espejos y puntas magnéticas



BE200M

Angle	Price (€)	Accessories
0°	70,02	1 BE200MAG4
0°	75,40	1 BE200MAG55
8°	74,10	1 BE200MAG80
35°	75,41	1 BE200MIR5535
45°	75,41	1 BE200MIR5545
55°	75,41	1 BE200MIR5555
35°	74,10	1 BE200MIR8035
45°	74,10	1 BE200MIR8045
55°	74,10	1 BE200MIR8055
35°	67,13	1 BE200MIR4035
55°	67,13	1 BE200MIR4055

Estetoscopio electrónico de mecánico



BE220

Dimensions	Weight (kg)	Price (€)	Accessories
130 x 370 x 340 mm	2.94 kg	242,36	1 BE220

Estetoscopio, sonda de acero



5050

Length (mm)	Price (€)	Accessories
1050 mm	101,06	1 5050

ESPEJOS

Espejo articulado



5515GV

Length (mm)	Price (€)	Accessories
215 mm	35,72	1 5515GV

Espejo telescópico con cabeza giratoria



5515T-52

Length (mm)	Price (€)	Accessories
255-450 mm	13,37	25 5515T-52

Espejo de inspección pivotante con LED y cable semirrígido aislado



5515FL

		€		
550 mm	62 x 38 mm	38,05	10	5515FL

Espejo de reparación con mango metálico



5515M

		€		
210 mm	30 mm	35,59	1	5515M

LUPAS

Lupa óptica



BOM10X

	€		
180 mm	38,11	10	BOM10X

Espejo de inspección pivotante con UV y cable semirrígido aislado



5515FUV

		€		
550 mm	65x42 mm	50,55	1	5515FUV

Espejo auxiliar



5515L

		€		
160 mm	21 mm	27,16	1	5515L

Lupa 10 aumentos



3046-OP

	€		
105 mm	40,04	12	3046-OP

Espejo de reparación en plástico



5515B

		€		
220 mm	28.5 mm	25,74	25	5515B

Espejo telescópico de bolsillo



5515T

		€		
180-690 mm	30 mm	31,44	25	5515T





BAHCO



Extractores



MECÁNICO

Extractor universal de dos garras



4532

		€		
25-80 mm	100 mm	108,82	1	4532-A
25-80 mm	200 mm	116,99	1	4532-AL
25-130 mm	100 mm	113,69	1	4532-B
25-130 mm	200 mm	123,93	1	4532-BL
50-160 mm	150 mm	188,42	1	4532-C
50-160 mm	300 mm	208,03	1	4532-CL
60-200 mm	150 mm	194,89	1	4532-D
80-250 mm	200 mm	304,40	1	4532-E
80-350 mm	200 mm	337,81	1	4532-F
110-520 mm	200 mm	564,50	1	4532-G
110-520 mm	300 mm	653,40	1	4532-G-SO
170-640 mm	225 mm	1.033,37	1	4532-H

Cuerpo: 4532/B; Par de garras: 4532K; Par de garras largas: 4532LK; Husillo: 4532/S

Brazos de repuesto para extractor 4532



4532K-4532LK

		€		
4532-A, 4532-B	100 mm	58,88	1	4532K1
4532-C, 4532-D	150 mm	99,65	1	4532K2
4532-E, 4532-F, 4532-G	200 mm	165,43	1	4532K3
4532-H	225 mm	289,57	1	4532K4
4532-AL, 4532-BL	200 mm	79,59	1	4532LK1
4532-CL	300 mm	133,04	1	4532LK2
4532-G-SO	300 mm	223,02	1	4532LK3
4532-E, 4532-F, 4532-G, 4532-G-SO	400 mm	267,75	1	4532LK4
4532-E, 4532-F, 4532-G, 4532-G-SO	500 mm	280,38	1	4532LK5

Husillo para extractor 4532



4532-S

	€		
4532-O, 4532-A, 4532-AL, 4532-B, 4532-BL	26,35	1	4532-OAB/S
4532-C, 4532-CL, 4532-D	49,89	1	4532-CD/S
4532-E, 4532-F, 4532-G, 4532-G-SO	89,23	1	4532-EFG/S
4532-H	139,82	1	4532-H/S

Extractor de garras estrechas



4532-0

		€		
20-90 mm	100 mm	122,51	1	4532-0

Cuerpo: 4532-0/B; Par de garras: 4532K0; Husillo: 4532-OAB/S

Extractor 2 brazos universal



3115

		€		
80-250 mm	300 mm	357,63	1	3115

Expositor de extractores de dos garras



4532ST/5

	€		
16700 g	920,85	1	4532ST/5

4532-A, 4532-B, 4532-C, 4532-D, 4532-E

Extractor de tres garras



4533

		€		
150-700 mm	185 mm	2.711,70	1	4533HP
150-700 mm	200 mm	2.474,61	1	4533M
	185 mm	638,91	1	4533HPK
	200 mm	459,36	1	4533MK
		585,90	1	4533HP/S
		194,70	1	4533M/S

4533HP - Sistema hidráulico; 4533M - Mecánico 4533K: Juego 3 garras; 4533/S: Husillo de repuesto

Gato hidráulico



4529

Tn max		€		
8 to	60 N·m	222,01	1	4529-8
15 to	70 N·m	267,36	1	4529-15

Extractor: Hidráulico de 3 garras - Industria Pesada



4528

Ø	h	€	📦	🐟
50-350 mm	135 mm	1.168,83	1	4528-1

Juego 3 garras:4528K; Cuerpo: 4528/B; Husillo sist. hidráulico 4533HP/S

Extractor de 2 y 3 garras



4544

Ø	h	€	📦	🐟
10-100 mm	80 mm	81,03	1	4544-1
10-120 mm	120 mm	128,25	1	4544-2
20-160 mm	160 mm	192,28	1	4544-3
20-200 mm	200 mm	262,43	1	4544-4
		19,51	1	4544-110/S
		38,45	1	4544-220/S
		61,51	1	4519-1/S
		46,73	1	4544-440/S

2 garras: 4544-1/4; 3garras:4544-10/30; Cuerpo:4544/B Garra:4544K; Husillo:4544/S

Extractores de tres garras de uso en la industria pesada con acabado galvanizado



4544-

Ø	h	€	📦	🐟
10-100 mm	80 mm	116,74	1	4544-10
10-120 mm	120 mm	174,49	1	4544-20
20-160 mm	160 mm	256,56	1	4544-30

Extractor de 2 o 3 garras



4543

Ø	h	€	📦	🐟
10-60 mm	40 mm	35,64	1	4543-1
10-70 mm	74 mm	37,64	1	4543-2
10-90 mm	84 mm	65,63	1	4543-3
		15,06	1	4543-1/S
		15,07	1	4543-2/S
		18,03	1	4543-3/S

2 garras: 4543-1/3; 3garras 4543-10/30; Cuerpo:4543/B; Garra:4543K; Husillo:4543/S

Extractores de tres garras de uso ligero con acabado galvanizado



4543-

Ø	h	€	📦	🐟
10-60 mm	40 mm	49,32	1	4543-10
10-70 mm	74 mm	53,31	1	4543-20
10-90 mm	84 mm	75,48	1	4543-30

Extractor de dos garras



4541

Ø	h	€	📦	🐟
20-150 mm	85 mm	109,87	1	4541-A
40-220 mm	130 mm	184,42	1	4541-B

Cuerpo: 4541/B; Garra: 4541K; Husillo A:4532-03B/S y Husillo B:4519-1/S 4532-4519/S: Husillo de repuesto

Extractor de 3 garras



4542

Ø	h	€	📦	🐟
20-150 mm	85 mm	142,07	1	4542-A
40-220 mm	130 mm	234,86	1	4542-B

Cuerpo: 4542/B; Garra: 4541K; Husillo A:4532-03B/S y Husillo B:4519-1/S 4532-4519/S: Husillo de repuesto

Extractor: 2 garras - Industria Pesada



4537

Ø	h	€	📦	🐟
20-170 mm	130 mm	98,05	1	4537-1
20-230 mm	200 mm	175,44	1	4537-2
50-300 mm	250 mm	253,81	1	4537-3
50-350 mm	350 mm	299,04	1	4537-4

Cuerpo: 4537/B; Garra: 4537K; Husillo 1: 4532-03B/S, husillo 2: 4519-1/S, husillo 3 y 4: 4519-2/S 4532-4519/S: Husillo de repuesto

Extractor de 3 garras - Industria Pesada



4528M

Ø	h	€	📦	🐟
20-170 mm	130 mm	123,96	1	4528M1
20-230 mm	200 mm	220,66	1	4528M2
50-300 mm	250 mm	328,83	1	4528M3
50-350 mm	350 mm	397,08	1	4528M4
50-400 mm	400 mm	407,22	1	4528M5

Cuerpo:4528M/B; Garra:4537K-4528MK; Husillo 1: 4532-03B/S, husillo 2: 4519-1/S, husillo 3, 4 y 5: 4519-2/S Husillo 4532/S-4519/S



Extractor con abrazadera



4519

Icon	Icon	€	Icon	Icon
20-110 mm	80-170 mm	270,35	1	4519-1
40-150 mm	90-270 mm	354,97	1	4519-2
40-150 mm	90-330 mm	405,06	1	4519-3

Cuerpo: 4519/B; Garra: 4519K; Husillo: 4519/S

Extractor para separador de guillotina



4552

Icon	€	Icon	Icon
4551-A-B	142,96	1	4552-1
4551-C	206,56	1	4552-2
4551-D	318,65	1	4552-3

Cuerpo: 4552/B; Garra: 4552K Husillo: 4532/S

Extractor de rodamientos sin garras



4581N-4583N

Icon	€	Icon	Icon
4581NA, 4581NB	62,07	1	4581N-1
4581NB2, 4581NC, 4582NA	62,07	1	4582N-1
4581NC, 4582NA, 4582NB	77,81	1	4582N-2
4582NA, 4583NA	98,05	1	4583N-1
4582NA, 4582NB, 4583NB	117,24	1	4583N-2

Extractor tipo tijera



4614

Icon	Icon	€	Icon	Icon
6-100 mm	70-85 mm	154,87	1	4614-1
10-140 mm	85-120 mm	189,27	1	4614-2

Cuerpo:4614/B; Par de garras:4614K; Husillo 4543-4532/S

Separador de guillotina



4551

Icon	€	Icon	Icon
4552-1	90,32	1	4551-A
4552-1	114,73	1	4551-B
4552-2	187,07	1	4551-C
4552-3	292,44	1	4551-D

4551A:10-60mm; 4551B:15-75mm 4551C:35-115mm; 4551D:40-150mm

Garras de repuesto - juego de 4 pzs



4581NA-4583NB

Icon	Icon	€	Icon	Icon
145 mm	4581N-1	82,41	1	4581NA
120 mm	4581N-1	88,76	1	4581NB
130 mm	4582N-1	94,95	1	4581NB2
130 mm	4582N-1, 4582N-2	95,17	1	4581NC
150 mm	4582N-1, 4582N-2, 4583N-1, 4583N-2	101,73	1	4582NA
150 mm	4582N-2, 4583N-2	106,16	1	4582NB
190 mm	4583N-1	162,35	1	4583NA
235 mm	4583N-2	266,15	1	4583NB

Extractores múltiples



4540

Icon	Icon	€	Icon	Icon
30-170 mm	65-140 mm	258,62	1	4540-17
		39,50	1	4540-17/S
75-250 mm	77-180 mm	382,24	1	4540-25
		49,35	1	4540-25/S

Juego de extractores y separadores



4574

Icon	€	Icon	Icon
105 x 300 x 360 mm	1.153,30	1	4574

4532-A, 4532-C

4532LK1, 4532LK2

4551-C

4529-15

Juego de extractores de rodamientos de bolas



4580N/7

Icon	€	Icon	Icon
66 x 192 x 287 mm	1.527,27	1	4580N/7

4581N-1, 4582N-1, 4582N-2, 4583N-1, 4583N-2, 4581NA to 4583NB

Juego extractores de rodamientos



4578

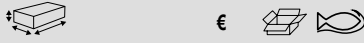

75 x 235 x 285 mm **597,74** 1 4578

4 jgos garras 4 pzs cada: 4581NA y 4581NB para 4581N-1; 4581NB2 y 4581NC para 4582N1 NB2-NC

Extractor interior para rodamientos



4521N



Dimensiones	€	Cant.	Ref.
5-7 mm	75,63	1	4521N-00
7-9 mm	75,62	1	4521N-0
9-12 mm	72,08	1	4521N-A
10-13 mm	72,08	1	4521N-B
13-17 mm	74,31	1	4521N-C
14-19 mm	74,31	1	4521N-D
16-21 mm	74,31	1	4521N-E
18-23 mm	84,52	1	4521N-F
20-25 mm	84,52	1	4521N-G
25-30 mm	86,95	1	4521N-H
30-37 mm	96,55	1	4521N-I
35-42 mm	118,97	1	4521N-K
38-45 mm	118,97	1	4521N-L
43-50 mm	148,43	1	4521N-M
40-75 mm	356,01	1	4521N-S
70-115 mm	424,78	1	4521N-T

Extractor 2 garras con acabado galvanizado



4522

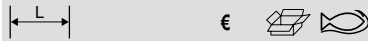

Dimensiones	€	Cant.	Ref.
35-75 mm	64,56	1	4522-1
60-130 mm	102,02	1	4522-2

Cuerpo:4522/B; Garra:4522/K; Husillo:4522/S 4522/S: Husillo de repuesto

Barra de impacto para cabezas 400 gr



4523G

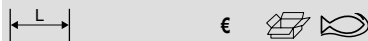

Dimensiones	€	Cant.	Ref.
Ø10x170 mm	76,44	1	4523G

Para 4521N-00/E

Barra de impacto para cabezas 1.3 kg



4524G



Dimensiones	€	Cant.	Ref.
Ø16 x 250 mm	108,61	1	4524G

Para 4521N-F & 4521N-M

Juego de extractores de rodamientos



4521N/7



95 x 360 x 310 mm 6800 g **1.196,54** 1 4521N/7

4521N-B, 4521N-D, 4521N-H, 4521N-I, 4521N-L, 4521N-S, 4521N-G

4522-2, 4522-1

Extractor universal de rótulas



4545-N



Max	Dimensiones	€	Cant.	Ref.
Max 50 mm	18-22 mm	119,81	1	4545-N1
Max 90 mm	27-36 mm	281,45	1	4545-N11
Max 50 mm	26 mm	164,62	1	4545-N2
60-80 mm	26 mm	206,15	1	4545-N21

Husillo: 4545/S

Extractor de cubos de ruedas



4518



Dimensiones	€	Cant.	Ref.
225 mm	140 mm	254,45	1 4518-3
225 mm	140 mm	310,89	1 4518-4
225 mm	140 mm	321,49	1 4518-5



Extractor de rótulas



4545

	€		
18 mm	58,58	1	4545-1
25 mm	79,64	1	4545-2
29 mm	103,55	1	4545-3
40 mm	136,30	1	4545-4
45 mm	166,49	1	4545-5

Juego de extractores para mantenimiento de vehículos



4577

	€		
70 x 340 x 425 mm	1.482,71	1	4577

4545-N2	
4532-B	
4614-1	
4521N-D, 4521N-B, 4521N-H, 4521N-I, 4521N-G, 4521N-L	
4522-1	

Juego extractores interiores y exteriores



4590SHS5

	€		
79 x 230 x 500 mm	200,60	4	4590SHS5

Juego extractores mini



4579

	€		
65 x 210 x 275 mm	237,80	1	4579

Extractores 2 garras: 4543-2, 4543-3; Cuerpos: 4543-1020/B, 4543-30/B; Garras: 4543K220, 4543K330

Tronzatuercas hidráulico



4610

	€		
M4-M14	236,47	1	4610-1

Tronzatuercas mecánico



4611

	€		
to M16	79,11	1	4611-2
to M24	154,96	1	4611-3

4611-2 Hoja: 4611-2/B; Husillo: 4611-2/S

Extractor de espárragos



4553

	€		
5-20 mm	64,31	1	4553

Grosor de cabeza: 10mm

Extractor de espárragos



4591-4593

	€		
10-19 mm	76,11	1	4592
5-15 mm	65,27	1	4591
18-28 mm	93,36	1	4593

Extractor de espárrago



1420-1424

	€		
M 3-6	3,37	1	1420-1.4
M 6-8	3,98	1	1421-2.1
M 8-11	5,55	1	1422-3.1
M11-14	6,82	1	1423-4.8
M14-18	8,17	1	1424-6.2

Juego de 5 extractores de espárragos



1435/5

	g	€	
15 x 50 x 90 mm	110 g	28,31	1 1435/5

1423-4.8, 1420-1.4, 1422-3.1, 1421-2.1, 1424-6.2

Juego de 8 extractores de espárragos



1435/8

	g	€	
29 x 110 x 118 mm	700 g	89,45	1 1435/8

M18-24 + M24-33 + M33-45

1420-1.4, 1421-2.1, 1422-3.1, 1423-4.8, 1424-6.2

Extractores para tornillos rotos



1419-M5/1419-M16

	€		
M5-M10	28,56	1	1419-M5
M8-M14	31,96	1	1419-M8
M12-M20	36,06	1	1419-M12
M16-M24	45,78	1	1419-M16

Juego de 4 extractores de espárragos para tornillos rotos



1419/4

	g	€	
M5-M24	430 g	129,93	1 1419/4

M5-M10; M8-M14; M12-M20; M16-M24

Juego 15 extractores de espárragos



BWMSP15

	kg	€	
43 x 90 x 200 mm	0.54 kg	103,46	1 BWMSP15

Puntas extractoras de espárragos



BWMSP15

		€	
3 mm	13 mm	5,12	1 BWMSP1501
4 mm	13 mm	5,12	1 BWMSP1502
5 mm	13 mm	5,12	1 BWMSP1503
5.5 mm	13 mm	5,12	1 BWMSP1504
6 mm	13 mm	5,12	1 BWMSP1505
8 mm	13 mm	5,12	1 BWMSP1506
10 mm	13 mm	5,12	1 BWMSP1507
1/8 in	13 mm	5,12	1 BWMSP1508
3/16 in	13 mm	5,12	1 BWMSP1509
1/4 in	13 mm	5,12	1 BWMSP1510
3/8 in	13 mm	5,12	1 BWMSP1511
11 mm	16 mm	5,58	1 BWMSP1512
12 mm	16 mm	5,58	1 BWMSP1513
14 mm	16 mm	5,58	1 BWMSP1514
1/2 in	16 mm	5,58	1 BWMSP1515

Juego de extractores de espárrago



1418S

		€	
25 x 127 x 162 mm	M6-M16	173,79	1 1418S

1418-4, 1418-5, 1418-6, 1418-7.5, 1418-8.5



Extractores de espárrago



1418

	€		
M5-M8	11,63	1	1418-4
M8-M10	13,77	1	1418-5
D11-M12	15,47	1	1418-6
M12-M14	17,61	1	1418-7.5
M14-M16	20,50	1	1418-8.5

Palanca especial



3680

L	€		
400 mm	64,33	1	3680

Palanca, varilla pasante



2484T-20/2484T-60

L	€		
210 mm	13,20	1	2484T-20
312 mm	18,86	1	2484T-30
450 mm	25,76	1	2484T-45
600 mm	30,45	1	2484T-60

PALANCAS

Extractor de clavos



2632

L	€		
170 mm	23,03	1	2632

Elevador con mango plástico



2484-20/2484-60

L	€		
205 mm	9,86	1	2484-20
305 mm	12,68	1	2484-30
465 mm	19,71	1	2484-45
615 mm	23,94	1	2484-60

Juego de palancas, varilla pasante



2484T/S4

Dimensions	g	€	
42 x 145 x 693 mm	1950 g	79,47	1 2484T/S4

Palanca



3684

L	€		
406 mm	24,53	1	3684-16
457 mm	33,71	1	3684-18
609 mm	43,75	1	3684-24
760 mm	73,52	1	3684-30

Juego de 4 palancas



2484/S4

Dimensions	€		
42 x 145 x 693 mm	49,30	10	2484/S4

Palanca



3683

L	€		
400 mm	53,27	1	3683

2484-20, 2484-30, 2484-45, 2484-60

Palanca polivalente



3681

L	€		
304 mm	31,92	1	3681-11
406 mm	38,32	1	3681-16
503 mm	47,89	1	3681-20

HERRAMIENTAS PARA RECOGIDA

Dedo magnético ERGO™

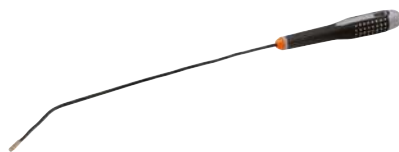

2535F0

Ø	L	€	
5.5 mm	515 mm	17,87	1 2535F0

Dedo magnético flexible



B147

Ø	L	€	
13 mm	400 mm	28,29	1 B147.001.400
19 mm	400 mm	30,98	1 B147.003.400

SB: Presentación en clip

Dedo magnético flexible



2535F

Ø	L	€	
10 mm	400 mm	39,39	1 2535F1
10 mm	400 mm	35,69	1 2535F2
17 mm	400 mm	64,65	1 2535F3

2535F2: Mango pequeño

Recogedora magnética con luz



2535L

Ø	L	€	
20 mm	40-670 mm	27,29	12 2535L

Dedo flexible con garras



2509

L	€	
555 mm	77,31	50 2509

Dedo flexible con garras



2530

L	€	
605 mm	6,65	1 2530

HERRAMIENTAS PARA ROSCAS

Juego de herramientas



1460M/1

Case Size	Thread Range	€	
53 x 407 x 220 mm	M5-M12	2.544,27	1 1460M/1

Juego de herramientas



1460M/2

Case Size	Thread Range	€	
53 x 407 x 220 mm	M5-M20	4.340,42	1 1460M/2



Juego de herramientas



1460Z/2

53 x 407 x 220 mm 1/4-3/4 **6.453,23** 1 1460Z/2

Giramachos de carraca reversible



600

3-10 mm **30,35** 1 600.003.010
 5-12 mm **39,20** 1 600.005.012

Lima doble para roscas interiores y exteriores, mm



1450D-ISO

230 mm **91,34** 1 1450D-ISO

Paso Rosca 5-27

Lima doble para roscas interiores y exteriores, pulgadas



1450D-WW

230 mm **91,34** 1 1450D-WW

Juego de limas dobles



1450D/2

40 x 70 x 270 mm M5-M27 **174,57** 1 1450D/2

1450D-ISO

1450D-WW



Almacenamiento de herramientas y composiciones



CARROS DE HERRAMIENTAS

Composiciones de herramientas de mantenimiento general en carro, 53", 488 piezas



XXL

	€		
986 x 501 x 1430 mm	7.956,75	1	XXL

1476KXXL7BK	
2058-BR	
6700SM-10, 6700SM-11, 6700SM-12, 6700SM-13, 6700SM-14, 6700SM-4, 6700SM-4.5, 6700SM-5, 6700SM-5.5, 6700SM-6, 6700SM-7, 6700SM-8, 6700SM-9	
6700TORX-E10, 6700TORX-E4, 6700TORX-E5, 6700TORX-E6, 6700TORX-E7, 6700TORX-E8	
6950SL	
6954	
6956	
6960, 6962, 6962L, 696EX-11	
6963	
6966	
6972H	
7400SM-10, 7400SM-11, 7400SM-12, 7400SM-13, 7400SM-14, 7400SM-15, 7400SM-16, 7400SM-17, 7400SM-18, 7400SM-19, 7400SM-20, 7400SM-21, 7400SM-22, 7400SM-6, 7400SM-7, 7400SM-8, 7400SM-9	
7400TORX-E10, 7400TORX-E11, 7400TORX-E12, 7400TORX-E14, 7400TORX-E16, 7400TORX-E18, 7400TORX-E8	
7406ZZ-16, 7406ZZ-21	
7409BH-10, 7409BH-4, 7409BH-5, 7409BH-6, 7409BH-8	
7409F-10, 7409F-6.5, 7409F-8	
7409TORX-R-T27, 7409TORX-R-T30, 7409TORX-R-T40, 7409TORX-R-T45, 7409TORX-R-T50	
7409TORX-T25, 7409TORX-T27, 7409TORX-T30, 7409TORX-T40, 7409TORX-T45, 7409TORX-T50	
7750SL	
7757, K6650-1/4-1P	
7758	
7759	
7760	

7761-W	
7764	
7765	
7766	
7767	
776EX-11	
7800SM-10, 7800SM-11, 7800SM-12, 7800SM-13, 7800SM-14, 7800SM-15, 7800SM-16, 7800SM-17, 7800SM-18, 7800SM-19, 7800SM-20, 7800SM-21, 7800SM-22, 7800SM-23, 7800SM-24, 7800SM-25, 7800SM-26, 7800SM-27, 7800SM-28, 7800SM-29, 7800SM-30, 7800SM-32, 7800SM-33, 7800SM-34, 7800SM-36, 7800SM-8, 7800SM-9	
7800TORX-E10, 7800TORX-E11, 7800TORX-E12, 7800TORX-E14, 7800TORX-E16, 7800TORX-E18, 7800TORX-E20, 7800TORX-E24, 7800TORX-E8	
7805SM-10, 7805SM-12, 7805SM-13, 7805SM-14, 7805SM-15, 7805SM-16, 7805SM-17, 7805SM-18, 7805SM-19, 7805SM-20, 7805SM-21, 7805SM-22, 7805SM-23, 7805SM-24, 7805SM-25, 7805SM-26, 7805SM-27, 7805SM-28, 7805SM-29, 7805SM-30, 7805SM-32	
7809M-10, 7809M-12, 7809M-14, 7809M-4, 7809M-5, 7809M-6, 7809M-7, 7809M-8	
7809M-10-140, 7809M-5-100, 7809M-6-100, 7809M-7-100, 7809M-8-120	
7809XZN-10, 7809XZN-10-100, 7809XZN-12, 7809XZN-12-100, 7809XZN-14, 7809XZN-14-100, 7809XZN-16, 7809XZN-18, 7809XZN-6, 7809XZN-8, 7809XZN-100	
8150SL	
8160-3, 8160-5	
8160W-10	
8164-1/2	
8171	
8166	
8167	
A6800DM-10, A6800DM-11, A6800DM-12, A6800DM-13, A6800DM-14, A6800DM-4, A6800DM-5, A6800DM-5.5, A6800DM-6, A6800DM-7, A6800DM-8, A6800DM-9	
A7402DM-10, A7402DM-11, A7402DM-12, A7402DM-13, A7402DM-14, A7402DM-15, A7402DM-16, A7402DM-17, A7402DM-18, A7402DM-19, A7402DM-21, A7402DM-21, A7402DM-7, A7402DM-8, A7402DM-9	
K6625-1/4-1P	
K6650-1/2-1P, K6650-3/8-1P	
2101G-160	
2421 G-140IP, 2421 G-180	
2427 G-200	
2430 G-160	
2628 G-180	
2800-140, 2800-180, 2800-225	
2890-125, 2890-180, 2890-210	
2900-140, 2900-180, 2900-215	
2951-250	
2952-165	
2990-140, 2990-180, 2990-200	
3416 A	
4130	
7224	

BE256-155, BE256-178, BE256-250	
BLTS7P	
CR W 01	
1150-1/2H/P	
1544	
2633/S4x 4	
59/S100BCx 100	
806-1-3	
808050L	
BE-7607	
BE-8020L	
BE-8155TB, BE-8256TB, BE-8258TB	
BE-8355	
BE-8600	
BE-8602	
BE-8610TB, BE-8620TB, BE-8623TB, BE-8624TB	
BE-8802	
BE-8810TB, BE-8820TB, BE-8823TB, BE-8824TB	
BE-8907, BE-8908, BE-8909, BE-8910, BE-8915, BE-8920, BE-8925, BE-8927, BE-8930, BE-8940	
BE-8986	
BE-9770x 9	
BE-9785x 13	
MTC-5-16-C1	
1-170-08-2-2	
1-210-08-2-2	
1-230-08-2-2	
208	
2484T-30, 2484T-60	
2509	
2535L	
319	
3625N-32	
3681-16	
3734-2, 3734-3, 3734-4, 3734-5, 3734-6, 3734-8	
3735-4-120, 3735-5-120	
3740-150, 3740-250	
3906-300-32-5Px 5	
479-08	
481-1000, 481-400	
5515T	
782-U	
KBGU-5P-DISPENx 5	
KERU-01	
111M-10, 111M-11, 111M-12, 111M-13, 111M-14, 111M-15, 111M-16, 111M-17, 111M-18, 111M-19, 111M-20, 111M-21, 111M-22, 111M-23, 111M-24, 111M-25, 111M-26, 111M-27, 111M-28, 111M-29, 111M-30, 111M-32, 111M-33, 111M-34, 111M-36, 111M-6, 111M-7, 111M-8, 111M-9	
1RM-10, 1RM-11, 1RM-12, 1RM-13, 1RM-14, 1RM-15, 1RM-16, 1RM-17, 1RM-18, 1RM-19, 1RM-21, 1RM-22, 1RM-24, 1RM-27, 1RM-30, 1RM-32, 1RM-6, 1RM-7, 1RM-8, 1RM-9	
4040M-10-11, 4040M-12-13, 4040M-14-15, 4040M-16-17, 4040M-18-19, 4040M-8-9	
8069, 8071, 8073	

Carro 40" 8 cajones + cofre 4 cajones con 758 herramientas



MONSTER



€



1370 x 501 x 1100 mm 8.249,56 1 MONSTER

FF1BSET-MONSTER

Carro 9 cajones E77 con composición para auto



AUTO



€



976 x 510 x 820 mm 4.408,04 1 AUTO

FF1ASET-AUTO

Carro E72 5 cajones con composición 158 piezas



BASIC1



€



952 x 510 x 782 mm 1.464,04 1 BASIC

FF1ASET-BASIC

Carro E77 9 cajones + cofre E87 4 cajones con 560 htas.



XLARGE



€



1360 x 510 x 820 mm 6.863,17 1 XLARGE

FF1ASET-XLARGE

Carro con composición general - 346 piezas



LARGE



€



952 x 510 x 782 mm 2.652,25 1 LARGE

FF1ASET-LARGE

Carro 40" negro con 6 cajones - 187 piezas



1475KXL6CBK-FF6



€



986 x 501 x 1100 mm 2.926,87 1 1475KXL6CBK-FF6

FF1A65



FF1A66



FF1A67



FF1A68



FF1A194



Carro 40" negro con 6 cajones - 210 piezas



1475KXL6CBK-FF5

€	Icon	Icon
986 x 501 x 1100 mm	1.624,39	1 1475KXL6CBK-FF5

FF1A48	Icon	Icon
FF1A49	Icon	Icon
FF1A50	Icon	Icon
FF1A51	Icon	Icon
FF1A213	Icon	Icon
FF1A53	Icon	Icon

Carro Premium E77 26" con 9 cajones



1477K9

€	Icon	Icon
976 x 510 x 820 mm	1.468,09	1 1477K9
976 x 510 x 820 mm	1.468,09	1 1477K9BLACK
976 x 510 x 820 mm	1.468,09	1 1477K9GREY
976 x 510 x 820 mm	1.468,09	1 1477K9WHITE
976 x 510 x 820 mm	1.468,09	1 1477K9RED

Carro Premium E77 26" con 8 cajones



1477K8

€	Icon	Icon
976 x 510 x 820 mm	1.424,39	1 1477K8
976 x 510 x 820 mm	1.424,39	1 1477K8BLACK

€	Icon	Icon
976 x 510 x 820 mm	1.424,39	1 1477K8GREY
976 x 510 x 820 mm	1.424,39	1 1477K8WHITE
976 x 510 x 820 mm	1.424,39	1 1477K8RED

Carro Premium E77 26" con 7 cajones



1477K7

€	Icon	Icon
976 x 510 x 820 mm	1.391,59	1 1477K7
976 x 510 x 820 mm	1.391,59	1 1477K7BLACK
976 x 510 x 820 mm	1.391,59	1 1477K7GREY
976 x 510 x 820 mm	1.391,59	1 1477K7WHITE
976 x 510 x 820 mm	1.391,59	1 1477K7RED

Carro Premium E77 26" con 6 cajones



1477K6

€	Icon	Icon
976 x 510 x 820 mm	1.326,02	1 1477K6
976 x 510 x 820 mm	1.326,02	1 1477K6BLACK
976 x 510 x 820 mm	1.326,02	1 1477K6GREY
976 x 510 x 820 mm	1.326,02	1 1477K6WHITE
976 x 510 x 820 mm	1.326,02	1 1477K6RED

Cofre Premium E87 26" con 4 cajones



1487K4

€	Icon	Icon
402 x 510 x 692 mm	1.003,31	1 1487K4
402 x 510 x 692 mm	1.003,31	1 1487K4BLACK
402 x 510 x 692 mm	1.003,31	1 1487K4GREY

Cofre Premium E87 con 4 cajones sobre ruedas



1487K4W

€	Icon	Icon
564 x 510 x 692 mm	1.025,47	1 1487K4W
564 x 510 x 692 mm	1.003,31	1 1487K4BKW

Carro E72 26" con 8 cajones



1472K8

€	Icon	Icon
952 x 510 x 782 mm	1.010,16	1 1472K8
952 x 510 x 782 mm	1.010,16	1 1472K8BLACK
952 x 510 x 782 mm	1.010,16	1 1472K8GREY
952 x 510 x 782 mm	1.010,16	1 1472K8WHITE
952 x 510 x 782 mm	1.010,16	1 1472K8RED
952 x 510 x 782 mm	1.010,16	1 1472K8BLUE

Carro E72 26" con 7 cajones



1472K7

	€		
952 x 510 x 782 mm	972,99	1	1472K7
952 x 510 x 782 mm	972,99	1	1472K7BLACK
952 x 510 x 782 mm	972,99	1	1472K7GREY
952 x 510 x 782 mm	972,99	1	1472K7WHITE
952 x 510 x 782 mm	972,99	1	1472K7RED
952 x 510 x 782 mm	972,99	1	1472K7BLUE

Carro E72 26" con 6 cajones



1472K6

	€		
952 x 510 x 782 mm	935,84	1	1472K6
952 x 510 x 782 mm	935,84	1	1472K6BLACK
952 x 510 x 782 mm	935,84	1	1472K6GREY
952 x 510 x 782 mm	935,84	1	1472K6WHITE
952 x 510 x 782 mm	935,84	1	1472K6RED
952 x 510 x 782 mm	935,84	1	1472K6BLUE

Carro E72 26" con 5 cajones



1472K5

	€		
952 x 510 x 782 mm	898,16	1	1472K5
952 x 510 x 782 mm	898,16	1	1472K5BLACK
952 x 510 x 782 mm	898,16	1	1472K5GREY
952 x 510 x 782 mm	898,16	1	1472K5WHITE
952 x 510 x 782 mm	898,16	1	1472K5RED
952 x 510 x 782 mm	898,16	1	1472K5BLUE

Cofre E82 26" con 4 cajones



1482K4

	€		
386 x 510 x 692 mm	572,89	1	1482K4
386 x 510 x 692 mm	572,89	1	1482K4BLACK
386 x 510 x 692 mm	572,89	1	1482K4GREY
386 x 510 x 692 mm	572,89	1	1482K4WHITE
386 x 510 x 692 mm	572,89	1	1482K4RED
386 x 510 x 692 mm	572,89	1	1482K4BLUE

Cofre E82 5 cajones sobre ruedas



1482K5W

	€		
542 x 515 x 699 mm	802,04	1	1482K5W

Cofres E82 4 cajones sobre ruedas



1482K4W

	€		
542 x 515 x 699 mm	716,11	1	1482K4W
542 x 515 x 699 mm	716,11	1	1482K4BKW

Panel de herramientas para 1477K



1477K-AC12

	€		
396 x 25 x 610 mm	177,05	1	1477K-AC12

Panel de herramientas superior lateral para 1477K



1477K-AC13

	€		
400 x 25 x 365 mm	118,04	1	1477K-AC13



Portadocumentos para 1477K



1477K-AC14

	€		
327 x 25 x 240 mm	53,12	1	1477K-AC14

Soporte para chaquetas para 1477K



1477K-AC17

	€		
68 x 65 x 435 mm	47,21	1	1477K-AC17

Soporte para latas para 1477K y 1472K



1477K-AC20

	€		
125 x 105 x 307 mm	42,49	1	1477K-AC20

Soporte para ordenador para 1477K



1477K-AC15

	€		
80 x 298 x 424 mm	141,64	1	1477K-AC15

Porta rollos de papel para 1477K y 1472K



1477K-AC18

	€		
33 x 265 x 313 mm	54,30	1	1477K-AC18

Soporte para herramienta neumática para 1477K y 1472K



1477K-AC21

	€		
115 x 175 x 302 mm	88,53	1	1477K-AC21

Soporte para lunas para 1477K



1477K-AC16

	€		
106 x 115 x 208 mm	236,07	1	1477K-AC16

Soporte para documentación para 1477K y 1472K



1477K-AC19

	€		
241 x 65 x 300 mm	47,21	1	1477K-AC19

Panel de herramientas lateral para 1477K y 1472K



1477K-AC22

	€		
659 x 18 x 300 mm	65,21	1	1477K-AC22

Bandeja metálica plegable para carros E72 y 777



1477K-AC30

	€		
22 x 430 x 460 mm	123,74	1	1477K-AC30

Sistema de bloqueo con código PIN



1477K-AC24

	€		
135 x 36 x 62 mm	324,60	1	1477K-AC24

Encimera con centro de madera para 1477K



1477K-ACTW

	€		
20 x 510 x 550 mm	247,88	1	1477K-ACTW

Divisores de cajón para carros de 26"



1477K-AC26

	kg	€		
48 x 2 x 147 mm	0.07	81,35	1	1477K-AC26

Sistema de Bloqueo MIFARE para 1477K



1477K-AC25

	€		
135 x 36 x 62 mm	413,14	1	1477K-AC25

Encimera de composite para 1477K



1477K-ACTP

	€		
20 x 510 x 550 mm	102,70	1	1477K-ACTP

Cajón inferior para 1477K



1477K-AC10

	€		
110 x 390 x 495 mm	92,90	1	1477K-AC10

Encimera central de acero inoxidable para 1477K



1477K-ACTSS

	€		
20 x 510 x 550 mm	283,29	1	1477K-ACTSS

Encimera central para 1477K



1477K-ACTD

	€		
20 x 510 x 550 mm	201,20	1	1477K-ACTD



Encimera de acero inoxidable para 1472K



1472K-ACTSS

	€		
30 x 501 x 682 mm	330,50	1	1472K-ACTSS

Carro 53" con 7 cajones



1476KXXL7BK

	€		
986 x 501 x 1430 mm	2.864,43	1	1476KXXL7BK

Carro Classic C75 40" con 12 cajones



1475KXXL12

	€		
986 x 501 x 1100 mm	1.652,81	1	1475KXXL12
986 x 501 x 1100 mm	1.652,81	1	1475KXXL12BLACK
986 x 501 x 1100 mm	1.652,81	1	1475KXXL12RED

Encimera de madera de castaño para 1472K



1472K-ACTW

	€		
30 x 501 x 680 mm	305,72	1	1472K-ACTW

Carro 53" con 12 cajones



1471KXXL12BKTS

	€		
1016 x 501 x 1440 mm	2.732,67	1	1471KXXL12BKTS

Carro Classic C75 40" con 8 cajones



1475KXXL8

	€		
986 x 501 x 1100 mm	1.599,25	1	1475KXXL8
986 x 501 x 1100 mm	1.599,25	1	1475KXXL8BLACK
986 x 501 x 1100 mm	1.599,25	1	1475KXXL8BLUE
986 x 501 x 1100 mm	1.599,25	1	1475KXXL8RED

Encimera MDF para 1472K



1472K-ACTD

	€		
30 x 501 x 682 mm	247,88	1	1472K-ACTD

Carro C75 extra grande



1475KXXL8CWTSS

	€		
1218 x 500 x 1505 mm 1089 kg	4.662,48	1	1475KXXL8CWTSS

Carro Classic C75 40" con 7 cajones



1475KXXL7

	€		
986 x 501 x 1100 mm	1.555,53	1	1475KXXL7
986 x 501 x 1100 mm	1.555,53	1	1475KXXL7BLACK
986 x 501 x 1100 mm	1.555,53	1	1475KXXL7BLUE
986 x 501 x 1100 mm	1.555,53	1	1475KXXL7RED

Carro Classic C75 40" 6 cajones



1475KXL6

Icon	€	Icon	Icon
986 x 501 x 1100 mm	1.500,89	1	1475KXL6
986 x 501 x 1100 mm	1.500,89	1	1475KXL6BLACK
986 x 501 x 1100 mm	1.500,89	1	1475KXL6BLUE
986 x 501 x 1100 mm	1.500,89	1	1475KXL6RED

Carro Classic C75 26" con 8 cajones



1475K8

Icon	€	Icon	Icon
956 x 501 x 763 mm	1.096,50	1	1475K8
956 x 501 x 763 mm	1.096,50	1	1475K8BLACK
956 x 501 x 763 mm	1.096,50	1	1475K8BLUE
956 x 501 x 763 mm	1.096,50	1	1475K8RED

Carro especial altura baja



1470K7LH

Icon	€	Icon	Icon
755 x 501 x 760 mm	781,13	1	1470K7LH
755 x 501 x 760 mm	781,13	1	1470K7LHBLUE
755 x 501 x 760 mm	781,13	1	1470K7LHGREY
755 x 501 x 760 mm	781,13	1	1470K7LHRED

Carro Classic C75 40" con 6 cajones y armario



1475KXL6C

Icon	€	Icon	Icon
986 x 501 x 1100 mm	1.610,18	1	1475KXL6C
986 x 501 x 1100 mm	1.610,18	1	1475KXL6CBLACK

Carro Classic C75 26" con 7 cajones



1475K7

Icon	€	Icon	Icon
956 x 501 x 763 mm	1.055,04	1	1475K7
956 x 501 x 763 mm	1.055,04	1	1475K7BLACK
956 x 501 x 763 mm	1.055,04	1	1475K7BLUE
956 x 501 x 763 mm	1.055,04	1	1475K7RED

Cofre Classic C85, 26" con 4 cajones



1485K4

Icon	€	Icon	Icon
417 x 500 x 677 mm	631,50	1	1485K4
417 x 500 x 677 mm	631,50	1	1485K4BLACK
417 x 500 x 677 mm	631,50	1	1485K4BLUE
417 x 500 x 677 mm	631,50	1	1485K4RED

Cofre Classic C85, 40" con 4 cajones



1485KXL4

Icon	€	Icon	Icon
417 x 500 x 1016 mm	820,36	1	1485KXL4
417 x 500 x 1016 mm	820,36	1	1485KXL4BLACK
417 x 500 x 1016 mm	820,36	1	1485KXL4BLUE
417 x 500 x 1016 mm	820,36	1	1485KXL4RED

Carro Classic C75



1475K6

Icon	€	Icon	Icon
956 x 501 x 763 mm	1.019,99	1	1475K6
956 x 501 x 763 mm	1.019,99	1	1475K6BLACK
956 x 501 x 763 mm	1.019,99	1	1475K6BLUE
956 x 501 x 763 mm	1.019,99	1	1475K6RED

Encimera de acero inoxidable para carro 53"



1475KXXL-ACTSS

Icon	€	Icon	Icon
45 x 495 x 1347 mm	392,53	1	1475KXXL-ACTSS



Encimera de madera para carro 53"



1475KXXL-ACTW

	€		
45 x 495 x 1347 mm	710,80	1	1475KXXL-ACTW

Encimera DM 26" y 40"



1470K-ACTD

	€		
40 x 495 x 1012 mm	252,99	1	1470KXL-ACTD
40 x 497 x 674 mm	197,45	1	1470K-ACTD

Barra metálica de 23 agujeros para destornilladores



1470K-AC2

	€		
280 x 100 x 428 mm	121,98	1	1470K-AC2

Se sujeta a los laterales del carro

Encimera de Acero Inox 26" y 40"



1470K-ACTSS

	€		
40 x 495 x 1010 mm	462,21	1	1470KXL-ACTSS
38 x 495 x 670 mm	385,18	1	1470K-ACTSS

Armario lateral negro para carro 1475KXL



1475KXL-AC20BK

	€		
820 x 503 x 419 mm	473,84	1	1475KXL-AC20BK

Accesorio lateral para carros



1470K-AC3

	€		
140 x 90 x 457 mm	44,94	1	1470K-AC3

Encimera de madera de castaño



1470K-ACTW

	€		
40 x 500 x 1012 mm	377,63	1	1470KXL-ACTW
40 x 497 x 674 mm	239,17	1	1470K-ACTW

Bandeja plegable para carro



1470K-AC1

	€		
9 x 455 x 395 mm	102,72	1	1470K-AC1

Superficie 455x460

Porta documentos para carros



1470K-AC4

	€		
180 x 83 x 360 mm	51,36	1	1470K-AC4

Panel metálico perforado para alojar herramientas



1470K-AC8

	€		
822 x 20 x 418 mm	83,46	1	1470K-AC8

Dimensiones: 822x429mm

Panel perforado para carros 26"



1470K-AC8

	€		
850 x 25 x 680 mm	103,83	1	1470K-AC8
850 x 25 x 680 mm	103,83	1	1470K-AC8GR

1470K-AC8GR : Gris

Carros de acero de tres bandejas



1470KC3A

	€		
1051 x 435 x 764 mm	198,04	1	1470KC3A

Encimera de ABS para carros de 26"



1470K-AC7

	€		
45 x 497 x 674 mm	129,58	1	1470K-AC7

Bandeja metálica ajustable para carros con armario en lateral



1470KXLC-TRAY

	€		
470 x 10 x 310 mm	67,89	1	1470KXLC-TRAY

Carro dos bandejas



1470KC2

	€		
1051 x 435 x 764 mm	181,63	1	1470KC2

Panel lateral con agujeros y ganchos



1475K-AC8

	€		
822 x 20 x 418 mm	63,02	1	1475K-AC8

Carro de dos bandejas



1470KC5

	€		
1051 x 435 x 1381 mm	605,37	1	1470KC5
1051 x 435 x 1381 mm	605,37	1	1470KC5PC

Bandeja central para 1470KC2



1470KCTRAY

		€		
750 mm	420 mm	45,15	1	1470KCTRAY



Transportador plegable con capacidad de 120 Kg



1430FT120

		€		
1077 x 520 x 487 mm	6.4 kg	127,48	1	1430FT120

Composición para uso general en 11 foams, 758 piezas



FF1BSET-MONSTER

	€		
40 x 445 x 880 mm	6.868,90	1	FF1BSET-MONSTER

FF1B01LM	
FF1B02LM	
FF1B03LM	
FF1B04LM	
FF1B05LM	
FF1B10LM	
FF1B11LM	
FF1B08LM	
FF1B09LM	
FF1B06LM	
FF1B07LM	

Incluye 141 piezas



FF1B01LM

	€		
35 x 445 x 880 mm	664,55	1	FF1B01LM

6700SM-10, 6700SM-11, 6700SM-12, 6700SM-13, 6700SM-14, 6700SM-4, 6700SM-4.5, 6700SM-5, 6700SM-5.5, 6700SM-6, 6700SM-7, 6700SM-8, 6700SM-9		
6700SZ-1/2, 6700SZ-1/8, 6700SZ-9/16, 6700SZ-1/4, 6700SZ-11/32, 6700SZ-3/16, 6700SZ-3/8, 6700SZ-5/16, 6700SZ-7/16, 6700SZ-7/32, 6700SZ-9/32, 6700SZ-5/32		
6700TORX-E4, 6700TORX-E5, 6700TORX-E6, 6700TORX-E7, 6700TORX-E8, 6700TORX-E10		
6950SL		
6962L, 6960, 6961		
6972H		
7400SM-10, 7400SM-11, 7400SM-12, 7400SM-13, 7400SM-14, 7400SM-15, 7400SM-16, 7400SM-17, 7400SM-18, 7400SM-19, 7400SM-20, 7400SM-21, 7400SM-22, 7400SM-6, 7400SM-7, 7400SM-8, 7400SM-9		
7400TORX-E10, 7400TORX-E11, 7400TORX-E12, 7400TORX-E14, 7400TORX-E16, 7400TORX-E18		
7406ZZ-16, 7406ZZ-21		
7409TORX-R-T27, 7409TORX-R-T30, 7409TORX-R-T40, 7409TORX-R-T45, 7409TORX-R-T50		
7409TORX-T25, 7409TORX-T27, 7409TORX-T30, 7409TORX-T40, 7409TORX-T45, 7409TORX-T50		
7750SL		
2058-BR		
8164-1/2		
A6800DM-10, A6800DM-12, A6800DM-13, A6800DM-4, A6800DM-5, A6800DM-5.5, A6800DM-6, A6800DM-7, A6800DM-8, A6800DM-9, A6800DM-11, A6800DM-14		
A6800DZ-9/16, A6800DZ-1/2, A6800DZ-1/4, A6800DZ-11/32, A6800DZ-3/16, A6800DZ-3/8, A6800DZ-5/16, A6800DZ-7/16, A6800DZ-7/32, A6800DZ-9/32		
A7400DZ-1/2, A7400DZ-11/16, A7400DZ-3/4, A7400DZ-3/8, A7400DZ-5/8, A7400DZ-7/16, A7400DZ-17/32, A7400DZ-9/16, A7400DZ-19/32, A7400DZ-13/16, A7400DZ-7/8, A7400DZ-1/4, A7400DZ-5/16		
K6650-1/4-1P		
K6625-1/4-1P		
6954		

6956		
6963		
6966		
7760, 7761, 7762		
7764		
7765		
7766		
7409BH-4, 7409BH-5, 7409BH-6, 7409BH-8, 7409BH-10		
A7402DM-10, A7402DM-11, A7402DM-12, A7402DM-13, A7402DM-14, A7402DM-15, A7402DM-16, A7402DM-17, A7402DM-18, A7402DM-19, A7402DM-8, A7402DM-9		
K6650-3/8-1P		
7756		

Incluye 76 piezas



FF1B02LM

	€		
40 x 445 x 880 mm	859,33	1	FF1B02LM

7800DM-10, 7800DM-11, 7800DM-12, 7800DM-13, 7800DM-14, 7800DM-15, 7800DM-16, 7800DM-17, 7800DM-18, 7800DM-19, 7800DM-20, 7800DM-21, 7800DM-22, 7800DM-24, 7800DM-27, 7800DM-30, 7800DM-32, 7800DM-34, 7800DM-36		
7800DZ-1, 7800DZ-1.1/16, 7800DZ-1.1/4, 7800DZ-1.1/8, 7800DZ-1.3/16, 7800DZ-1/2, 7800DZ-11/16, 7800DZ-13/16, 7800DZ-15/16, 7800DZ-25/32, 7800DZ-3/4, 7800DZ-3/8, 7800DZ-5/8, 7800DZ-7/16, 7800DZ-7/8, 7800DZ-9/16, 7800DZ-19/32		
7809M-10, 7809M-12, 7809M-14, 7809M-4, 7809M-5, 7809M-6, 7809M-7, 7809M-8		
8150SL		
SBS87		
K7801M-13, K7801M-15, K7801M-16, K7801M-17, K7801M-18, K7801M-19, K7801M-21, K7801M-22, K7801M-24		
K8160D-2		
K7806M-13, K7806M-14, K7806M-16, K7806M-17, K7806M-18, K7806M-19, K7806M-21, K7806M-22, K7806M-24		
7809M-5-100, 7809M-6-100, 7809M-7-100, 7809M-8-120, 7809M-10-140		
K6650-1/2-1P		
8160-3, 8160-5, 8160-10		
8171		
8166		

Incluye 36 piezas



FF1B03LM

35 x 445 x 880 mm € 607,26 1 FF1B03LM

111M-10, 111M-11, 111M-12, 111M-13, 111M-14, 111M-15, 111M-16, 111M-17, 111M-18, 111M-19, 111M-20, 111M-21, 111M-22, 111M-24, 111M-27, 111M-30, 111M-32, 111M-34, 111M-8, 111M-9

1RM-10, 1RM-11, 1RM-12, 1RM-13, 1RM-14, 1RM-15, 1RM-16, 1RM-17, 1RM-18, 1RM-19, 1RM-21, 1RM-22, 1RM-24, 1RM-27, 1RM-8, 1RM-9

Incluye 26 piezas



FF1B04LM

35 x 445 x 880 mm € 744,75 1 FF1B04LM

1RM-30, 1RM-32

111Z-1, 111Z-1.1/16, 111Z-1.1/4, 111Z-1.1/8, 111Z-1/2, 111Z-11/16, 111Z-13/16, 111Z-15/16, 111Z-3/4, 111Z-3/8, 111Z-5/16, 111Z-5/8, 111Z-7/16, 111Z-7/8, 111Z-9/16

4040M-10-11, 4040M-12-13, 4040M-14-15, 4040M-16-17, 4040M-18-19, 4040M-8-9

5515T

BLTS7P

2535L

Incluye 32 piezas



FF1B05LM

35 x 445 x 880 mm € 744,75 1 FF1B05LM

1150-1/2H/P

1520 G

1620

2101S-160

21HDG-160

2223 S-150

2430 G-160

2430 S-200

2628 G-180

2628 S-180

2744

426TOR9

KBGU-10P-DISPEN

KERU-01

MTC-5-16-C1

8224

9029, 9031

806-1-3

C3330R

C3530

C3230

C3640

Incluye 88 piezas



FF1B06LM

40 x 445 x 880 mm € 401,02 1 FF1B06LM

700-2.5-50, 700-2-50, 700-3-50	
701-00-50, 701-0-50, 701-1-75	
703-10-50, 703-15-75, 703-6-50, 703-7-50, 703-8-50, 703-9-50	
808050L	
BE-8010S	
BE-8020, BE-8040	
BE-8040SL, BE-8050SL	
BE-8150, BE-8155, BE-8256	
BE-8355	
BE-8600, BE-8611, BE-8621, BE-8623	
BE-8600S	
BE-8602	
BE-8610SL, BE-8620SL	
BE-8702, BE-8725	
BE-8820SL	
BE-8870	
BE-8975B	
BE-9777B	
BE-9787	
BE-9770	
BE-9785	

Incluye 169 piezas



FF1B07LM

40 x 445 x 880 mm € 687,46 1 FF1B07LM

BE-8256TB, BE-8258TB	
BE-8620TB, BE-8623TB	
59/S100BC	
7455-200	
BE-8907, BE-8908, BE-8909, BE-8910, BE-8915, BE-8920, BE-8925, BE-8927, BE-8930, BE-8940	
BE-8811, BE-8821	
BE-8830	
BE-8802	
BE5049T	
BE-7607	



Incluye 45 piezas



FF1B08LM

	€		
40 x 445 x 880 mm	401,02	1	FF1B08LM

1-100-08-2-2	
1-170-08-2-2	
1-210-08-2-2	
1-230-08-2-2	
1435/5	
2484-30, 2484-45, 2484-60	
3734-2, 3734-3, 3734-4, 3734-5, 3734-6, 3734-8	
3735-4-120, 3735-5-120	
3740-150, 3740-250	
4543-3	
4611-3	
481-400	
7865	
3625N-32	
1418-4, 1418-5, 1418-6, 1418-7.5	

Incluye 21 piezas



FF1B09LM

	€		
35 x 445 x 880 mm	320,82	1	FF1B09LM

900T-025-100, 900T-030-100, 900T-040-150, 900T-050-150, 900T-060-200, 900T-080-200	
901T-010-100, 901T-015-150, 901T-020-150, 901T-025-150, 901T-027-150, 901T-030-200, 901T-040-200	
BE256-155, BE256-178, BE256-250	
BE66152	
BT10P325, BT10P330, BT10P338	
1544	

Incluye 20 piezas



FF1B10LM

	€		
45 x 445 x 880 mm	423,94	1	FF1B10LM

2633/S4	
2800-140, 2800-180	
2890-125, 2890-180	
2900-140, 2900-180	
2951-180	
2952-165	
2963-280	
2965-200	
2990-125, 2990-180	
BE-8986	
325	
2681	
CR B 02	

Incluye 104 piezas



FF1B11LM

	€		
50 x 445 x 880 mm	412,48	1	FF1B11LM

RAIL-264	
CLIPS-1/4	
CLIPS-3/8	
CLIPS-1/2	
SLX 17	

Composición para uso general en 12 foams, 560 piezas



FF1ASET-XLARGE

	€		
40 x 543 x 445 mm	4.743,50	1	FF1ASET-XLARGE

FF1A195LM	
FF1A196LM	
FF1A197LM	
FF1A198LM	
FF1A199LM	
FF1A200LM	
FF1A201LM	
FF1A202LM	
FF1A203LM	
FF1A204LM	
FF1A205LM	
FF1A206LM	

Composición para uso general en 6 foams, 346 piezas



FF1ASET-LARGE

	€		
40 x 543 x 445 mm	2.068,76	1	FF1ASET-LARGE

FF1A207LM	
FF1A208LM	
FF1A209LM	
FF1A210LM	
FF1A211LM	
FF1A212LM	

Composición para auto en 6 foams, 175 piezas



FF1ASET-BASIC

40 x 543 x 445 mm € 901,77 1 FF1ASET-BASIC

FF1A214LM

FF1A215LM

FF1A216LM

SET 7 FOAMS PARA MRO, 256 PIEZAS



FF1ASET-MRO2

530 x 600 x 800 mm € 2.833,78 1 FF1ASET-MRO2

FF1A130

FF1A131

FF1A132

FF1A133

FF1A134

FF1A135

FF1A136

SET 5 FOAMS PARA MRO, 188 PIEZAS



FF1ASET-MRO3

530 x 600 x 800 mm € 2.044,83 1 FF1ASET-MRO3

FF1A138

FF1A134

FF1A139

FF1A141

FF1A137

SET 4 FOAMS PARA MRO, 147 PIEZAS



FF1ASET-MRO4

530 x 600 x 800 mm € 1.375,07 1 FF1ASET-MRO4

FF1A143

FF1A145

FF1A134

FF1A142

SET 3 FOAMS PARA MRO, 84 PIEZAS



FF1ASET-MRO5

530 x 600 x 800 mm € 1.096,63 1 FF1ASET-MRO5

FF1A147

FF1A146

FF1A134

Composición para auto en 8 foams, 357 piezas



FF1ASET-AUTO

40 x 543 x 445 mm € 3.288,79 1 FF1ASET-AUTO

FF1A218LM

FF1A219LM

FF1A220LM

FF1A221LM

FF1A222LM

FF1A223LM

FF1A224LM

FF1A225LM

SET DE 5 FOAMS PARA AUTO-196 HERRAMIENTAS



FF1ASET-AUTO1

50 x 543 x 445 mm € 2.397,98 1 FF1ASET-AUTO1

FF1A19

FF1A20

FF1A21

FF1A23

FF1A22



SET DE 4 FOAMS PARA AUTO-168
HERRAMIENTAS



FF1ASET-AUTO2

€ 50 x 543 x 445 mm 1.694,48 1 FF1ASET-AUTO2

FF1A19	
FF1A24	
FF1A21	
FF1A25	

SET 3 FOAMS PARA AUTO, 140 PIEZAS



FF1ASET-AUTO3

€ 50 x 543 x 445 mm 1.444,89 1 FF1ASET-AUTO3

FF1A28	
FF1A26	
FF1A27	

Set de 4 foams para auto



FF1ASET-AUTO6

€ 50 x 543 x 445 mm 1.410,55 1 FF1ASET-AUTO6

FF1A19	
FF1A72	
FF1A70	
FF1A71	

Incluye 62 piezas



FF1ASET-AUTO-M1

€ 50 x 543 x 445 mm 887,97 1 FF1ASET-AUTO-M1

BP910	
BP909TH	
BE-9678	
BE-9675	
29M-30	
2997-250	
1995LM-9, 1995LM-8, 1995LM-6	
3750	
1177-SCRIBE	
K7801M-9, K7801M-10, K7801M-11, K7801M-12, K7801M-13, K7801M-14, K7801M-15, K7801M-16, K7801M-17, K7801M-18, K7801M-19, K7801M-21, K7801M-22, K7801M-23, K7801M-24, K7801M-30, K7801M-32	
K7806M-15, K7806M-21, K7806M-24, K7806M-27	
K8901M-32, K8901M-34, K8901M-36	
K8964D	
K8167S	

K8160D-3	
2800-150	
2900-150	
3734S/6	
BE-8258TB	

Incluye 54 piezas



FF1ASET-AUTO-M2

€ 60 x 543 x 445 mm 1.798,86 1 FF1ASET-AUTO-M2

BE301	
K7801TORX-E10, K7801TORX-E12, K7801TORX-E14, K7801TORX-E16, K7801TORX-E18, K7801TORX-E20	
K8160D-2	
BE301CM	
BWHEPSSH8	
BE51038, BE510310, BE510312	
BP822	
BP825	

Incluye 34 piezas



FF1ASET-AUTO-M3

€ 40 x 543 x 445 mm 922,35 1 FF1ASET-AUTO-M3

BE1GP5T	
6968	
BE1SP1F	
BE6OF108	
BE6307414F	
BE6OFW	

BE1FFWF	
BE63064514F1	
BE6810Z, BE6810	
BE6FCP	
52	
1546	
5515M	
BE1P	
7455-60	
BE1FLD2, BE1FLD1, BE1FLD3	
BE65F65120	
7764	
8164-1/2	
BE6302712F	
6962-W	
6954	
BE6701VAG	
BE62110	
BE1310P427	
7406ZZ-21, 7406ZZ-16	
BE1SP14L	
BE1GP5	
2421GC-160IP	
8166	

Incluye 23 piezas



FF1ASET-AUTO-M4

	€		
60 x 543 x 445 mm	1.317,64	1	FF1ASET-AUTO-M4

BS618	
4545-N1, 4545-N11	
4545-1, 4545-2	
MTB-3-16	
361-14	
8900SM-41	
BS52	
747-22, 747-21, 747-19, 747-17, 747-15, 747-14, 747-13, 747-12	
BS40VAG	
BS56	
BS100PSA1	
BS45BMW	
8157-24	
8171	

Incluye 32 piezas



FF1ASET-AUTO-M5

	€		
45 x 543 x 445 mm	572,89	1	FF1ASET-AUTO-M5

319	
484-1000	
SB3654BM-20	
3625S-44	
B192.004.200	
BE-8258TB	
2484/S4	
6225D	
B194.030.150, B194.025.125, B194.020.100, B194.010.075	
600.005.012	
BBS165	
K7801TORX-E10, K7801TORX-E12, K7801TORX-E14, K7801TORX-E16, K7801TORX-E18, K7801TORX-E20, K7801TORX-E24	
BBR203P920, BBR203P925, BBR203P930, BBR203P940, BBR203P945, BBR203P950, BBR203P955, BBR203P960	

Incluye 42 piezas



FF1ASET-AUTO-M6

	€		
40 x 543 x 445 mm	1.048,38	1	FF1ASET-AUTO-M6

FM10	
782-U	

BBR405	
BBR400	
BBR210P3	
BBR6131	
BBR204	
BBR1501	
BBR501011, BBR50121314	
2900-215	
7823	
BBR100	
1154	
6M-16-17, 6M-14-15	
1949M-17-19, 1949M-12-13, 1949M-10-11, 1949M-8-9	

Incluye 139 piezas



FF1A195LM

	€		
40 x 445 x 543 mm	401,02	1	FF1A195LM

A6800DZ-9/16, A6800DZ-1/2, A6800DZ-1/4, A6800DZ-11/32, A6800DZ-3/16, A6800DZ-3/8, A6800DZ-5/16, A6800DZ-7/16, A6800DZ-7/32, A6800DZ-9/32	
K6625-1/4-1P	
K6650-1/4-1P	
6954	
6963	
K6650-3/8-1P	
7767	
8167	
2058-BR	
59/S31B	
SL25L	
S330L	



Incluye 67 piezas



FF1A196LM

	€		
40 x 445 x 543 mm	504,14	1	FF1A196LM

7800DZ-1.1/16, 7800DZ-1.1/4, 7800DZ-1.1/8, 7800DZ-1.3/16, 7800DZ-1/2, 7800DZ-11/16, 7800DZ-13/16, 7800DZ-15/16, 7800DZ-25/32, 7800DZ-3/4, 7800DZ-3/8, 7800DZ-5/8, 7800DZ-7/16, 7800DZ-7/8, 7800DZ-9/16, 7800DZ-19/32		
7809M-10, 7809M-12, 7809M-14, 7809M-4, 7809M-5, 7809M-6, 7809M-7, 7809M-8		
7809M-5-100, 7809M-6-100, 7809M-7-100, 7809M-8-120, 7809M-10-140		
K6650-1/2-1P		
S1612L		
8967		
S240		

Incluye 36 piezas



FF1A197LM

	€		
40 x 445 x 543 mm	423,94	1	FF1A197LM

1150-1/2H/P		
2744		
426TOR9		
K7801M-13, K7801M-15, K7801M-16, K7801M-17, K7801M-18, K7801M-19, K7801M-21, K7801M-22, K7801M-24		
K8160D-2		
K7806M-13, K7806M-14, K7806M-16, K7806M-17, K7806M-18, K7806M-19, K7806M-21, K7806M-22, K7806M-24		
KBGU-10P-DISPEN		

KERU-01

MTC-5-16-C1

325

1544



Incluye 20 piezas



FF1A198LM

	€		
35 x 445 x 543 mm	286,44	1	FF1A198LM

111M-10, 111M-11, 111M-12, 111M-13, 111M-14, 111M-15, 111M-16, 111M-17, 111M-18, 111M-19, 111M-20, 111M-21, 111M-22, 111M-24, 111M-27, 111M-30, 111M-32, 111M-34, 111M-8, 111M-9		
--	--	--

Incluye 23 piezas



FF1A199LM

	€		
35 x 445 x 543 mm	607,26	1	FF1A199LM

1RM-10, 1RM-11, 1RM-12, 1RM-13, 1RM-14, 1RM-15, 1RM-16, 1RM-17, 1RM-18, 1RM-19, 1RM-21, 1RM-22, 1RM-24, 1RM-8, 1RM-9		
4040M-10-11, 4040M-12-13, 4040M-14-15, 4040M-16-17, 4040M-18-19, 4040M-8-9		
9029, 9031		

Incluye 14 piezas



FF1A200LM

	€		
35 x 445 x 543 mm	492,68	1	FF1A200LM

1520 G		
1620		
2101G-160		
2223 S-150		1000 V
2233 D-160		
2430 G-190HD		
2628 G-180		
2890-180		
2990-180		
C3330R		
C3530		
C3230		
C3640		
8224		

Incluye 37 piezas



FF1A201LM

	€		
40 x 445 x 543 mm	263,53	1	FF1A201LM

BE-8256TB		
BE-8620TB, BE-8623TB		
700-2-50		
701-00-50, 701-0-50, 701-1-75		
703-10-50, 703-15-75, 703-6-50, 703-7-50, 703-8-50, 703-9-50		
BE-8040SL		
BE-8040		

BE-8150, BE-8155, BE-8256		
BE-8355		
BE-8600, BE-8611, BE-8621, BE-8623		
BE-8602		
BE-8811, BE-8821		
BE-8802		
BE-8870		
BE-9787		

Incluye 39 piezas



FF1A202LM

	€		
40 x 445 x 543 mm	171,87	1	FF1A202LM

900T-025-100, 900T-030-100, 900T-040-150, 900T-050-150, 900T-060-200, 900T-080-200		
BE-8907, BE-8908, BE-8909, BE-8910, BE-8915, BE-8920, BE-8925, BE-8927, BE-8930		
BE-8702, BE-8725		
BE-9770		
BE-9785		

Incluye 114 piezas



FF1A203LM

	€		
40 x 445 x 543 mm	160,41	1	FF1A203LM

59/S100BC		
808050L		
2058-BR		
901T-010-100, 901T-015-150, 901T-020-150, 901T-025-150, 901T-027-150, 901T-030-200, 901T-040-200		

Incluye 40 piezas



FF1A204LM

	€		
40 x 445 x 543 mm	263,53	1	FF1A204LM

1-100-08-2-2		
1-170-08-2-2		
1-210-08-2-2		
1-230-08-2-2		
1435/5		
3734-2, 3734-3, 3734-4, 3734-5, 3734-6, 3734-8		
3735-4-120, 3735-5-120		
3740-150, 3740-250		
481-400		
7865		
3625N-32		
1418-4, 1418-5, 1418-6, 1418-7.5		

Incluye 14 piezas



FF1A205LM

	€		
35 x 445 x 543 mm	263,53	1	FF1A205LM

2484-45		
2633/S4		
2951-180		
5515T		
BE66152		
BE-8986		
BT10P330		
2681		
1450D-ISO		
806-1-3		
5515FL		

Incluye 17 piezas



FF1A206LM

	€		
50 x 445 x 543 mm	366,65	1	FF1A206LM

SLX 17



Incluye 192 piezas



FF1A207LM

	€		
40 x 445 x 543 mm	446,85	1	FF1A207LM

1150-1/2H/P		
59/S100BC		
808050L		
2058-BR		
K6650-1/4-1P		
6956		
6963		
K6650-3/8-1P		
8967/S3		
6966		
6954		
696EX-08		
904T-060-150		
905T-060-100		
6973A		
SL25L		
S330		



Incluye 56 piezas



FF1A208LM

	€		
45 x 445 x 543 mm	389,56	1	FF1A208LM

2744	
7809M-10, 7809M-12, 7809M-14, 7809M-4, 7809M-5, 7809M-6, 7809M-7, 7809M-8	
K7801M-13, K7801M-15, K7801M-16, K7801M-17, K7801M-18, K7801M-19, K7801M-21, K7801M-22, K7801M-24	
K8160D-2	
KBGU-10P-DISPEN	
KERU-01	
319	
K6650-1/2-1P	
S240	

Incluye 21 piezas



FF1A209LM

	€		
35 x 445 x 543 mm	320,82	1	FF1A209LM

111M-10, 111M-11, 111M-12, 111M-13, 111M-14, 111M-15, 111M-16, 111M-17, 111M-18, 111M-19, 111M-20, 111M-21, 111M-22, 111M-24, 111M-27, 111M-30, 111M-32, 111M-34, 111M-8, 111M-9	
2535L	

Incluye 24 piezas



ergo



FF1A210LM

	€		
40 x 445 x 543 mm	435,39	1	FF1A210LM

1RM-10, 1RM-11, 1RM-12, 1RM-13, 1RM-14, 1RM-15, 1RM-16, 1RM-17, 1RM-18, 1RM-19, 1RM-8, 1RM-9	
1520 G	
2101G-160	
2430 G-190HD	
2628 G-180	
BE-8602	
BE-8611, BE-8621	
BE-8811, BE-8821	
BE-8802	
8224	
9031	

Incluye 35 piezas



ergo



FF1A211LM

	€		
40 x 445 x 543 mm	194,78	1	FF1A211LM

900T-025-100, 900T-030-100, 900T-040-150, 900T-050-150, 900T-060-200, 900T-080-200	
BE-8910, BE-8915, BE-8920, BE-8925, BE-8930	
BE-8020, BE-8040	
BE-8050SL	
BE-8150, BE-8155	
BE-8355	
BE-9787	
BE-9770	

Incluye 18 piezas



ergo



FF1A212LM

	€		
35 x 445 x 543 mm	217,70	1	FF1A212LM

1-100-08-2-2	
1-210-08-2-2	
1-230-08-2-2	
3734-2, 3734-3, 3734-4, 3734-5, 3734-6, 3734-8	
3735-4-120	
3740-150, 3740-250	
426TOR9	
481-400	
BE-8986	
MTC-5-16-C1	
2446	
3625N-32	

Incluye 85 piezas



FF1A213

	€		
52 x 445 x 543 mm	985,36	1	FF1A213

8150SL	
7800SM-8, 7800SM-9, 7800SM-12, 7800SM-13, 7800SM-10, 7800SM-11, 7800SM-30, 7800SM-32, 7800SM-24, 7800SM-22, 7800SM-23, 7800SM-27, 7800SM-16, 7800SM-17, 7800SM-14, 7800SM-15, 7800SM-21, 7800SM-18, 7800SM-19	
7455-200	

7809TORX-T45, 7809TORX-T40, 7809TORX-T30, 7809TORX-T20, 7809TORX-T25		
7809M-6, 7809M-5, 7809M-8, 7809M-7, 7809M-10, 7809M-14, 7809M-12		
7809M-6-140, 7809M-5-180, 7809M-10- 140, 7809M-8-120		
6950SL		
6962-W, K6650-1/4-1P		
6960-W		
6968		
6700SM-9, 6700SM-10, 6700SM-7, 6700SM-8, 6700SM-13, 6700SM-14, 6700SM-11, 6700SM-12, 6700SM-4, 6700SM-6, 6700SM-5		
6709M-6, 6709M-8, 6709M-4, 6709M-5, 6709M-3		
A6709M-2.5, A6709M-5, A6709M-6, A6709M-3, A6709M-4		
6962L		
7400SM-17, 7400SM-18, 7400SM-15, 7400SM-16, 7400SM-19, 7400SM-9, 7400SM-10, 7400SM-7, 7400SM-8, 7400SM-13, 7400SM-14, 7400SM-11, 7400SM-12, 7400SM-6		
7760-W, 7761-W		
7750SL		
7768		
8160-5, 8160-10		
8166		

Incluye 91 piezas



FF1A214LM

	€		
40 x 445 x 543 mm	343,73	1	FF1A214LM

2058-BR	
K6650-1/4-1P	
6956	
6963	
K6650-1/2-1P	
SL25	
8072	
2971G-250	
806-1-3	
2171G-160	
59/S31B	
S240	

Incluye 31 piezas



FF1A215LM

	€		
40 x 445 x 543 mm	297,90	1	FF1A215LM

111M-10, 111M-11, 111M-12, 111M-13, 111M-14, 111M-15, 111M-16, 111M-17, 111M-18, 111M-19, 111M-20, 111M-21, 111M-22, 111M-24, 111M-8, 111M-9		
BE-8910, BE-8915, BE-8920, BE-8925, BE-8930		
BE-8020, BE-8040		
BE-8155		
BE-8355		
BE-8602		
BE-8611, BE-8621		
BE-8811, BE-8821		
BE-8802		

Incluye 36 piezas



FF1A216LM

	€		
40 x 445 x 543 mm	229,15	1	FF1A216LM

1-100-08-2-2		
1-210-08-2-2		
1-230-08-2-2		
3734-3, 3734-4, 3734-5		
3735-4-120		
481-400		
BE-8986		
BE-9770		
S4RM-8-11, S4RM-12-15, S4RM-16-19		
KB18-01		

KSBG18-10DISPEN

MTG-3-16	
WR2-MM	
3740-200	
317	

Incluye 79 piezas



FF1A218LM

	€		
45 x 445 x 543 mm	630,17	1	FF1A218LM

1178-SCRIBE	
1547	
74WR-200	
7805ZZ-16, 7805ZZ-21	
BBR201P64014, BBR201P64016, BBR201P64018, BBR201P67814, BBR201P67816, BBR201P67818	
BWSS12P3	
MTC-3-13-C1	
7800SM-34, 7800SM-36	
SL25L	
SR200-MM	
S240	

Incluye 49 piezas



FF1A219LM

	€		
35 x 445 x 543 mm	366,65	1	FF1A219LM

1-100-08-2-2		
S1612L		
S18HEX		
S18TORX		



Incluye 21 piezas



FF1A220LM



€



35 x 445 x 543 mm

309,36

1 FF1A220LM

111M-10, 111M-11, 111M-12, 111M-13,
111M-14, 111M-15, 111M-16, 111M-17,
111M-18, 111M-19, 111M-20, 111M-21,
111M-22, 111M-23, 111M-24, 111M-27,
111M-30, 111M-32, 111M-8, 111M-9

8071

Incluye 42 piezas



FF1A221LM



€



40 x 445 x 543 mm

572,89

1 FF1A221LM

1RM-10, 1RM-11, 1RM-12, 1RM-13,
1RM-14, 1RM-17, 1RM-19, 1RM-8

2681

4040M-10-11, 4040M-12-13, 4040M-
14-15, 4040M-16-17, 4040M-18-19,
4040M-8-9

8045LVDE

806-1-1

808050

808050S

9715-14-250

BE-9575

BE-9770

Incluye 65 piezas



FF1A222LM



€



45 x 445 x 543 mm

389,56

1 FF1A222LM

BE-7805, BE-7806, BE-7807, BE-7808,
BE-7809, BE-7810, BE-7811, BE-7813,
BE-7855

D/S14

K8160D-1, K8160D-2

K8167S

BE-8135TB, BE-8145TB, BE-8150TB,
BE-8155TB

BE-8610TB, BE-8620TB, BE-8623TB

1150-1/2H/P

59/S31B

Incluye 15 piezas



FF1A223LM



€



35 x 445 x 543 mm

332,27

1 FF1A223LM

5226 DC

158-N

158-NB

21HDG-200

2430 G-190HD

2628G-200IP

2968-190

8224 IP

BE1P

BE1TH-2.5, BE1TH-3, BE1TH-4,
BE1TH-5, BE1TH-6, BE1TH-8

Incluye 26 piezas



FF1A224LM



€



40 x 445 x 543 mm

274,99

1 FF1A224LM

1435/8

319

3625S-35

3734S/6

3735-5-150

3740-200

3750

3906-300-24-2P

479-16

KBFU-01

BE256P3

Incluye 60 piezas



FF1A225LM



€



40 x 445 x 543 mm

286,44

1 FF1A225LM

2487

2535F1

2633/S4

2485

782-U

BE5049T

BE66152

2484-45

5515T-52

FF1A01 - 77 piezas



FF1A01

	€		
45 x 445 x 543 mm	699,63	1	FF1A01

A6800DM-4, A6800DM-5, A6800DM-6, A6800DM-7, A6800DM-8, A6800DM-9, A6800DM-10, A6800DM-11, A6800DM-12, A6800DM-13		
6700SM-4.5, 6700SM-5, 6700SM-5.5, 6700SM-6, 6700SM-7, 6700SM-8, 6700SM-9, 6700SM-10, 6700SM-11, 6700SM-12, 6700SM-13, 6700SM-4		
59S/22-1		
6950SL		
6954		
6956		
6960, 6961		
6966		
6972H		
7800SM-18, 7800SM-19, 7800SM-10, 7800SM-11, 7800SM-12, 7800SM-13, 7800SM-14, 7800SM-15, 7800SM-16, 7800SM-17, 7800SM-22, 7800SM-27, 7800SM-24, 7800SM-30, 7800SM-32		
7805ZZ-21		
7807H		
B191.040.100, B191.055.150		
B192.001.100, B192.002.125		
8150SL		
8154-11		
8160-3, 8160-10		
8166		

FF1A02 - 25 piezas



FF1A02

	€		
45 x 445 x 543 mm	257,26	1	FF1A02

111M-12, 111M-13, 111M-14, 111M-17, 111M-19, 111M-22, 111M-6, 111M-7, 111M-8, 111M-10		
6M-6-7, 6M-8-9, 6M-10-11, 6M-12-13, 6M-14-15, 6M-16-17, 6M-18-19, 6M-20-22		
808050L		

FF1A03 - 18 piezas



FF1A03

	€		
50 x 445 x 543 mm	208,29	1	FF1A03

BE-9770		
MTB-5-25		
3734N-4-150, 3734N-6-150		
1-100-08-2-2		
2171G-160		
2971G-250		
481-400		
2678 G-160		
306		

FF1A04 - 30 piezas



FF1A04

	€		
50 x 445 x 543 mm	469,15	1	FF1A04

S4RM-12-15, S4RM-16-19, S4RM-8-11		
111M-30, 111M-32, 111M-6, 111M-7, 111M-8, 111M-9, 111M-10, 111M-11, 111M-12, 111M-13, 111M-14, 111M-15, 111M-16, 111M-17, 111M-18, 111M-19, 111M-21, 111M-22, 111M-24, 111M-27		
6M-10-11, 6M-12-13, 6M-14-15, 6M-17-19, 6M-6-7, 6M-8-9		
9071C		

Juego de destornilladores a carraca y puntas en bandeja de foam 3/3 Fit&Go con marcado láser (104 piezas)



FF1A051

	€		
50 x 445 x 543 mm	718,11	1	FF1A051

BE-9678		
SBS60-4, SBS60-4.5, SBS60-5, SBS60-5.5, SBS60-6, SBS60-7, SBS60-8, SBS60-9, SBS60-10, SBS60-11, SBS60-12, SBS60-13, SBS60-14		
SBS61		
SBS63-2, SBS63-4, SBS63-6		
SBS65		
SBS67		
SBS69		
7800SM-10, 7800SM-11, 7800SM-12, 7800SM-13, 7800SM-14, 7800SM-15, 7800SM-16, 7800SM-18, 7800SM-19, 7800SM-21, 7800SM-17, 7800SM-22, 7800SM-24, 7800SM-27, 7800SM-32, 7800SM-30		
SBS88		
59S/31-1		
6956		
6972H		
7809M-5, 7809M-6, 7809M-7, 7809M-8, 7809M-10, 7809M-12, 7809M-14, 7809M-17, 7809M-19		
7809TORX-T20, 7809TORX-T25, 7809TORX-T27, 7809TORX-T30, 7809TORX-T40, 7809TORX-T45, 7809TORX-T50, 7809TORX-T55, 7809TORX-T60		
808050		
8150SL		
8154-11		
8160-W		
8160-10		
8166		
6954		



FF1A06 - 23 piezas



FF1A06

45 x 445 x 543 mm € 414,56 1 FF1A06

BE-8020L, BE-8040		
BE-8150, BE-8255, BE-8256		
BE-8350		
BE-8601		
BE-8610, BE-8620		
BE-8910, BE-8915, BE-8920, BE-8925, BE-8927, BE-8930		
MTB-3-16		
2101G-160IP		
2427 G-200 IP		
2535L		
2628 G-160IP		
2951-180		
5515T-52		
8224 IP		

FF1A07 - 15 piezas



FF1A07

40 x 445 x 543 mm € 249,17 1 FF1A07

3734N-3-150, 3734N-5-150, 3734N-6-150		
3735N-4-120		
3740-175		
SQZ150003		
1-100-08-2-2		
1-210-08-2-2		
1-230-08-2-2		
2744		
3625W-35		

3745-150	
481-400	
782-U	
317	

FF1A08 - 168 piezas



FF1A08

60 x 445 x 543 mm € 1.652,00 1 FF1A08

A6800DM-5.5, A6800DM-6, A6800DM-7, A6800DM-8, A6800DM-9, A6800DM-10, A6800DM-11, A6800DM-12, A6800DM-13		
A7402DM-10, A7402DM-11, A7402DM-12, A7402DM-13, A7402DM-14, A7402DM-15, A7402DM-16, A7402DM-17, A7402DM-18, A7402DM-19		
1544		
2058-BR		
6700SM-5.5, 6700SM-6, 6700SM-7, 6700SM-8, 6700SM-9, 6700SM-10, 6700SM-11, 6700SM-12, 6700SM-13		
6709M-3, 6709M-4, 6709M-5, 6709M-6, 6709M-8		
6709PH-1, 6709PH-2, 6709PH-3		
6709TORX-T20, 6709TORX-T25, 6709TORX-T27, 6709TORX-T30, 6709TORX-T40, 6709TORX-T8, 6709TORX-T9, 6709TORX-T10, 6709TORX-T15		
6950SL		
6954		
6956		
6958		
6960, 6961, 6962, 6962L		
6966		
6972H		
7400SM-6, 7400SM-7, 7400SM-8, 7400SM-9, 7400SM-10, 7400SM-11, 7400SM-12, 7400SM-13, 7400SM-14, 7400SM-15, 7400SM-16, 7400SM-17, 7400SM-18, 7400SM-19, 7400SM-22		
7407H		
7409M-3, 7409M-4, 7409M-5, 7409M-6, 7409M-7, 7409M-8, 7409M-10		
7409TORX-T25, 7409TORX-T27, 7409TORX-T30, 7409TORX-T40, 7409TORX-T45, 7409TORX-T50		
7750SL		
7754		
7758		
7760, 7761, 7762		
7764		
7765		

7766		
7800SM-10, 7800SM-11, 7800SM-12, 7800SM-13, 7800SM-14, 7800SM-15, 7800SM-16, 7800SM-17, 7800SM-18, 7800SM-19, 7800SM-21, 7800SM-22, 7800SM-24, 7800SM-27, 7800SM-30, 7800SM-32		

7807H		
7809M-5, 7809M-6, 7809M-7, 7809M-8, 7809M-10, 7809M-12, 7809M-14, 7809M-17, 7809M-19		

7809TORX-T20, 7809TORX-T25, 7809TORX-T27, 7809TORX-T30, 7809TORX-T40, 7809TORX-T45, 7809TORX-T55, 7809TORX-T50, 7809TORX-T60		
--	--	--

8150SL		
8164-1/2		
8154-11		
8160-5, 8160-10		
8171		
8166		
8172		

FF1A09 - 34 piezas



FF1A09

50 x 445 x 543 mm € 524,87 1 FF1A09

111M-30, 111M-32, 111M-6, 111M-7, 111M-8, 111M-9, 111M-10, 111M-11, 111M-12, 111M-13, 111M-14, 111M-15, 111M-16, 111M-17, 111M-18, 111M-19, 111M-21, 111M-22, 111M-24, 111M-27		
--	--	--

1320RM-10-11, 1320RM-12-13, 1320RM-8-9		
--	--	--

6M-6-7, 6M-8-9, 6M-10-11, 6M-12-13, 6M-14-15, 6M-16-17, 6M-18-19, 6M-20-22, 6M-24-27, 6M-30-32		
--	--	--

9071C		
-------	--	--

FF1A1004 - 19 piezas



FF1A1004

38 x 445 x 543 mm € 144,62 1 FF1A1004

900T-050-150, 900T-020-100, 900T-025-100, 900T-030-100, 900T-040-150, 900T-060-200, 900T-080-200, 900T-100-200



BE-9777B

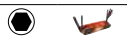

FF1A1010 - 54 piezas



FF1A1010

51 x 445 x 543 mm € 237,08 1 FF1A1010

901T-010-100, 901T-015-150, 901T-020-150, 901T-025-150, 901T-027-150, 901T-030-200, 901T-040-200



808050



1419-MD



7805DM-10, 7805DM-12, 7805DM-13, 7805DM-17, 7805DM-19



BE-9678



59S/31-1



FF1A1011 - 12 piezas

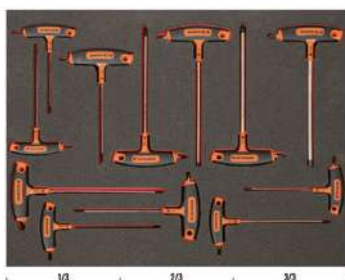

FF1A1011

35 x 445 x 543 mm € 112,46 1 FF1A1011

903T-2



903T-1



FF1A102 - 24 piezas



FF1A102

40 x 445 x 543 mm € 351,75 1 FF1A102

111M-32, 111M-8, 111M-9, 111M-10, 111M-11, 111M-12, 111M-13, 111M-14, 111M-15, 111M-16, 111M-17, 111M-18, 111M-19, 111M-21, 111M-22, 111M-24, 111M-27



7224



2800-180



2900-180



2890-180

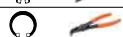

2990-180



2101G-180



2628 G-180IP



FF1A104 - 19 piezas



FF1A104

35 x 445 x 543 mm € 201,53 1 FF1A104

111M-32, 111M-7, 111M-8, 111M-9, 111M-10, 111M-11, 111M-12, 111M-13, 111M-14, 111M-15, 111M-16, 111M-17, 111M-18, 111M-19, 111M-21, 111M-22, 111M-24, 111M-27



59/S54BC



FF1A106 - 93 piezas



FF1A106

55 x 543 x 445 mm € 326,96 1 FF1A106

S87+7



FF1A11 - 13 piezas



FF1A11

43 x 543 x 445 mm € 692,99 1 FF1A11

2101GC-125IP, 2101GC-160IP



21HDGC-200IP



2427 GC-200IP



2430 GC-200 IP



2628 GC-160IP



2928-160, 2928-200, 2928-250



2951-250



2952-165



8224CIP



BFLA01



FF1A110 - 11 piezas



FF1A110

	€		
50 x 445 x 543 mm	259,69	1	FF1A110

2535L	
426TOR9	
9572-200	
MTB-8-25	
SQZ150003	
3875-LY3	
479-24	
481-400	
529-20-L	
225-PLUS	
208	

FF1A112 - 22 piezas



FF1A112

	€		
35 x 445 x 543 mm	285,65	1	FF1A112

S4RM/3T	
111M-6, 111M-7, 111M-8, 111M-9, 111M-10, 111M-11, 111M-12, 111M-13, 111M-14, 111M-15, 111M-16, 111M-17, 111M-18, 111M-19, 111M-20, 111M-21, 111M-22, 111M-24, 111M-27	
9031	
9070	

FF1A114 - 18 piezas



FF1A114

	€		
42 x 445 x 543 mm	344,67	1	FF1A114

8224 IP	
2632	
3734-2, 3734-3, 3734-4, 3734-5, 3734-6, 3734-8	
2800-180	
2890-180	
2900-180	
2990-180	
4611-2	
479-24	
1435/5	
1178-SCRIBE	
2430 G-160 IP	
2101G-180IP	

FF1A115 - 9 piezas



FF1A115

	€		
35 x 445 x 543 mm	232,41	1	FF1A115

1-210-08-1-2	
9045-B-250	
406T-225	
MTB-5-25	
BFLA01	
K-AP-1	
268	
5515T-52	
319	

FF1A117 - 26 piezas



FF1A117

	€		
35 x 445 x 543 mm	227,81	1	FF1A117

B191.040.100	
B190.055.125, B190.065.150	
B192.000.075, B192.001.100, B192.002.125	
111M-32, 111M-6, 111M-7, 111M-8, 111M-9, 111M-10, 111M-11, 111M-12, 111M-13, 111M-14, 111M-15, 111M-16, 111M-17, 111M-18, 111M-19, 111M-21, 111M-22, 111M-24, 111M-27	
8073 IP	

FF1A118 - 14 piezas



FF1A118

	€		
35 x 445 x 543 mm	319,88	1	FF1A118

1-100-08-2-2	
2430 G-160 IP	
2628G-200IP	
2800-180	
2900-180	
2890-180	
2990-180	
5515T	
1-170-08-2-2	
1-210-08-2-2	
1-230-08-2-2	
2535F1	
8224 IP	
2101G-180IP	

FF1A119 - 10 piezas



FF1A119

47 x 445 x 543 mm 297,46 € 1 FF1A119

- 3734S/6
- 481-300
- KGAU-01
- MTB-5-25-M-E
- 137-10
- 1150-1/2H/P
- 426TOR9
- BLTS10
- 375-8
- 319

FF1A12 - 19 piezas



FF1A12

35 x 445 x 543 mm 393,57 € 1 FF1A12

- FS-8
- 1-100-06-1-2, 1-100-06-2-2
- 1-160-06-1-2
- 1-210-06-1-2
- 1-230-06-1-2
- 2509
- 2535F2
- 3625W-35
- 3734-3, 3734-5, 3734-8
- 3735-4-120
- 3740-150
- 3745-150
- 481-300, 481-500
- 319
- 8157-15

FF1A121 - 28 piezas



FF1A121

40 x 445 x 543 mm 336,41 € 1 FF1A121

- 111M-8, 111M-9, 111M-10, 111M-11, 111M-12, 111M-13, 111M-14, 111M-15, 111M-16, 111M-17, 111M-18, 111M-19, 111M-22
- 2470 G-200
- 7224
- 2953-250
- 6M-6-7, 6M-8-9, 6M-10-11, 6M-12-13, 6M-14-15, 6M-16-17, 6M-18-19, 6M-20-22
- 2800-180
- 2900-180
- 2101G-160IP

FF1A124 - 25 piezas



FF1A124

45 x 445 x 543 mm 201,53 € 1 FF1A124

- B191.040.100
- B190.055.125, B190.065.150
- B192.000.075, B192.001.100, B192.002.125
- 111M-32, 111M-6, 111M-7, 111M-8, 111M-9, 111M-10, 111M-11, 111M-12, 111M-13, 111M-14, 111M-15, 111M-16, 111M-17, 111M-18, 111M-19, 111M-21, 111M-22, 111M-24, 111M-27

FF1A127 - 11 piezas



FF1A127

35 x 445 x 543 mm 248,94 € 1 FF1A127

- 3734S/6
- 479-16
- 3625W-35
- MTG-3-16
- KB18-01
- KSBG18-10DISPEN
- 8224 IP
- 2101G-160IP
- 2628 G-180IP
- 2430 G-200 IP
- 2530

FF1A128 - 18 piezas



FF1A128

65 x 445 x 543 mm 449,73 € 1 FF1A128

- 9029, 9031
- 111Z-1/4, 111Z-5/16, 111Z-3/8, 111Z-7/16, 111Z-1/2, 111Z-9/16, 111Z-5/8, 111Z-11/16, 111Z-3/4, 111Z-13/16, 111Z-7/8, 111Z-1
- 1-473-08-2-2
- 361-12
- 2633/S4
- S4RM/5T



FF1A129 - 40 piezas



FF1A129

45 x 445 x 543 mm € 352,93 1 FF1A129

2171G-180	
2470 G-200	
2477 G-200	
9033, 9035	
1520 G	
808050P	
B191.040.100	
B190.055.125, B190.065.150	
B192.000.075, B192.001.100, B192.002.125	
BE-9777B	
2678 G-200	
59S/31-1	

FF1A13 - 83 piezas



FF1A13

55 x 445 x 543 mm € 1.572,64 1 FF1A13

A6700DZ-1/2, A6700DZ-1/4, A6700DZ-11/32, A6700DZ-3/16, A6700DZ-3/8, A6700DZ-5/16, A6700DZ-7/16, A6700DZ-7/32, A6700DZ-9/16, A6700DZ-9/32	
A6710DZ-1/2, A6710DZ-1/4, A6710DZ-11/32, A6710DZ-3/16, A6710DZ-3/8, A6710DZ-5/16, A6710DZ-7/16, A6710DZ-7/32, A6710DZ-9/16, A6710DZ-9/32	
A6800DM-4, A6800DM-10	
A6800DZ-1/2, A6800DZ-1/4, A6800DZ-11/32, A6800DZ-3/16, A6800DZ-3/8, A6800DZ-5/16, A6800DZ-7/16, A6800DZ-7/32, A6800DZ-9/16, A6800DZ-9/32	
A7400DZ-1/2, A7400DZ-1/4, A7400DZ-11/16, A7400DZ-13/16, A7400DZ-17/32, A7400DZ-19/32, A7400DZ-3/4, A7400DZ-3/8, A7400DZ-5/16, A7400DZ-5/8, A7400DZ-7/16, A7400DZ-7/8, A7400DZ-9/16	

A7402DZ-1/2, A7402DZ-1/4, A7402DZ-11/16, A7402DZ-13/16, A7402DZ-19/32, A7402DZ-3/4, A7402DZ-3/8, A7402DZ-5/16, A7402DZ-5/8, A7402DZ-7/16, A7402DZ-7/8, A7402DZ-9/16	
6700SZ-5/32	
6950SL	
6954	
6956	
6958	
6960, 6961, 6962, 6962L	
6966	
6972H	
7407H, 7408H	
7750SL	
7752	
7754	
7758	
7760, 7761, 7762	
7764	
7765	
7766	
8164-1/2	
U-S6106KA	
8171	

FF1A130 - 53 piezas



FF1A130

45 x 445 x 543 mm € 711,25 1 FF1A130

7800SM-8, 7800SM-9, 7800SM-10, 7800SM-11, 7800SM-12, 7800SM-13, 7800SM-14, 7800SM-15, 7800SM-16, 7800SM-17, 7800SM-18, 7800SM-19, 7800SM-21, 7800SM-22, 7800SM-23, 7800SM-24, 7800SM-27, 7800SM-30, 7800SM-32	
8150SL	
SBS87S, SBS87	
SBS83-3, SBS83-5, SBS83-10	
SBS85	
SBS86	
SBS88	
SBS89	
7809TORX-T20, 7809TORX-T25, 7809TORX-T27, 7809TORX-T30, 7809TORX-T40, 7809TORX-T45, 7809TORX-T50, 7809TORX-T55, 7809TORX-T60	

7809M-5, 7809M-6, 7809M-7, 7809M-8, 7809M-9, 7809M-10, 7809M-12, 7809M-14, 7809M-17, 7809M-19	
7809M-5-180, 7809M-6-140, 7809M-7-100, 7809M-8-120, 7809M-10-140	

FF1A131 - 25 piezas



FF1A131

40 x 445 x 543 mm € 260,79 1 FF1A131

SQZ150003	
FS-8	
SQZ150003-SBL	
481-400	
3734-2, 3734-4, 3734-5, 3734-6, 3734-8, 3734-3	
3735-5-120	
3740-175	
BE-9678	
1547	
319	
208	
3625N-32	

FF1A132 - 31 piezas



FF1A132

40 x 445 x 543 mm € 385,27 1 FF1A132

7400SM-6, 7400SM-7, 7400SM-8, 7400SM-9, 7400SM-10, 7400SM-11, 7400SM-12, 7400SM-13, 7400SM-14, 7400SM-15, 7400SM-16, 7400SM-17, 7400SM-18, 7400SM-19	
7750SL	
SBS705	

SBS755	
SBS723, SBS724	
SBS775	
SBS760, SBS761, SBS762	
1-100-08-1-2	
1-160-08-1-2	
1-170-08-2-2	
1-210-08-1-2	
1-230-08-1-2	
2635	
1150D	
2681	

FF1A133 - 17 piezas



FF1A133

	€		
35 x 445 x 543 mm	154,10	1	FF1A133

900T-020-100, 900T-025-100, 900T-030-100, 900T-040-150, 900T-050-150, 900T-060-200, 900T-080-200, 900T-100-200	
B194.006.075, B194.007.075, B194.008.075, B194.009.075, B194.010.075, B194.015.100, B194.020.100, B194.025.125, B194.030.150	

FF1A134 - 21 piezas



FF1A134

	€		
37 x 445 x 543 mm	213,38	1	FF1A134

111M-30, 111M-32, 111M-6, 111M-7, 111M-8, 111M-9, 111M-10, 111M-11, 111M-12, 111M-13, 111M-14, 111M-15, 111M-16, 111M-17, 111M-18, 111M-19, 111M-20, 111M-21, 111M-22, 111M-24, 111M-27	
---	--

FF1A135 - 51 piezas



FF1A135

	€		
40 x 445 x 543 mm	651,98	1	FF1A135

4040M-8-9, 4040M-10-11, 4040M-12-13, 4040M-14-15, 4040M-16-17, 4040M-18-19, 4040M-20-22, 4040M-21-23	
59S/31-1	
6M-6-7, 6M-8-9, 6M-10-11, 6M-12-13, 6M-14-15, 6M-16-17, 6M-18-19, 6M-20-22, 6M-21-23, 6M-24-27, 6M-25-28, 6M-30-32	

FF1A136 - 39 piezas



FF1A136

	€		
40 x 445 x 543 mm	438,61	1	FF1A136

2628 G-180	
2430 G-160	
8224	
2101G-160	
6700SM-4.5, 6700SM-5, 6700SM-5.5, 6700SM-6, 6700SM-7, 6700SM-8, 6700SM-9, 6700SM-10, 6700SM-11, 6700SM-12, 6700SM-13, 6700SM-14, 6700SM-4	
6950SL	
SBS67	
SBS69	
SBS65	
SBS63-2, SBS63-4, SBS63-6	
2800-180	
2890-180	

2900-180	
2990-180	
B191.030.075, B191.040.100	
B190.055.100, B190.065.125, B190.080.150	
B195.050.025	
B195.001.025	
B192.001.100, B192.002.125	
808050	
6954	

FF1A137 - 59 piezas



FF1A137

	€		
50 x 445 x 543 mm	651,98	1	FF1A137

7800SM-8, 7800SM-9, 7800SM-10, 7800SM-11, 7800SM-12, 7800SM-13, 7800SM-14, 7800SM-15, 7800SM-16, 7800SM-17, 7800SM-18, 7800SM-19, 7800SM-21, 7800SM-22, 7800SM-23, 7800SM-24, 7800SM-27, 7800SM-30, 7800SM-32	
8150SL	
SBS87S, SBS87	
SBS83-3, SBS83-5, SBS83-10	
SBS85	
SBS86	
SBS88	
SBS89	
7809TORX-T50, 7809TORX-T20, 7809TORX-T25, 7809TORX-T27, 7809TORX-T30, 7809TORX-T40, 7809TORX-T45, 7809TORX-T55, 7809TORX-T60	
6700SM-4, 6700SM-4.5, 6700SM-5, 6700SM-5.5, 6700SM-6, 6700SM-7, 6700SM-8, 6700SM-9, 6700SM-10, 6700SM-11, 6700SM-12, 6700SM-13, 6700SM-14	
6950SL	
SBS67	
SBS69	
SBS65	
SBS63-2, SBS63-4, SBS63-6	
6954	



FF1A138 - 24 piezas



FF1A138

	€		
40 x 445 x 543 mm	254,87	1	FF1A138

SQZ150003	
FS-8	
SQZ150003-SBL	
481-400	
3734-2, 3734-3, 3734-4, 3734-5, 3734-6, 3734-8	
3735-5-120	
3740-175	
BE-9678	
319	
208	
3625N-32	

FF1A139 - 18 piezas



FF1A139

	€		
38 x 445 x 543 mm	189,67	1	FF1A139

808050	
900T-020-100, 900T-025-100, 900T-030-100, 900T-040-150, 900T-050-150, 900T-060-200, 900T-080-200, 900T-100-200	
B191.030.075, B191.040.100	
B190.055.100, B190.065.125, B190.080.150	
B195.050.025	
B195.001.025	
B192.001.100, B192.002.125	

FF1A14 - 43 piezas



FF1A14

	€		
46 x 445 x 543 mm	695,60	1	FF1A14

111Z-1, 111Z-1/2, 111Z-1/4, 111Z-11/16, 111Z-13/16, 111Z-15/16, 111Z-3/4, 111Z-3/8, 111Z-5/16, 111Z-5/8, 111Z-7/16, 111Z-7/8, 111Z-9/16	
1320RZ-1/2-9/16, 1320RZ-1/4-5/16, 1320RZ-3/8-7/16, 1320RZ-5/16-11/32	
1931Z-1/2, 1931Z-1/4, 1931Z-11/32, 1931Z-3/16, 1931Z-3/8, 1931Z-5/16, 1931Z-5/32, 1931Z-7/16, 1931Z-7/32, 1931Z-9/16, 1931Z-9/32	
1950MZ-3/8	
1952Z-11/32	
6Z-1.1/16-1.1/4, 6Z-1.1.1/8, 6Z-1/2-9/16, 6Z-1/4-5/16, 6Z-15/16-1, 6Z-19/32-11/16, 6Z-25/32-13/16, 6Z-3/8-7/16, 6Z-5/16-11/32, 6Z-5/8-3/4, 6Z-7/8-15/16	
8069 C IP	
9070C	

FF1A141 - 47 piezas

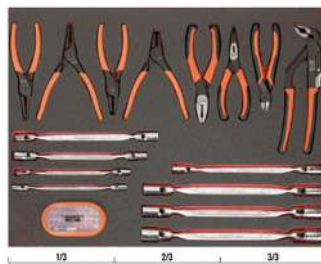

FF1A141

	€		
42 x 445 x 543 mm	734,96	1	FF1A141

2628 G-180	
2430 G-160	
8224	
2101G-160	
2800-180	
2890-180	
2900-180	
2990-180	

4040M-8-9, 4040M-10-11, 4040M-12-13, 4040M-14-15, 4040M-16-17, 4040M-18-19, 4040M-20-22, 4040M-21-23

59S/31-1

FF1A142 - 71 piezas



FF1A142

	€		
50 x 445 x 543 mm	628,26	1	FF1A142

7800SM-8, 7800SM-9, 7800SM-10, 7800SM-11, 7800SM-12, 7800SM-13, 7800SM-14, 7800SM-15, 7800SM-16, 7800SM-17, 7800SM-18, 7800SM-19, 7800SM-21, 7800SM-22, 7800SM-23, 7800SM-24, 7800SM-27, 7800SM-30, 7800SM-32

8150SL

BE-9678

SBS87S, SBS87

1547

1150D

59S/31-1

8160-3, 8160-5, 8160-10

8166

8154-11

8171

8172

FF1A143 - 16 piezas











FF1A143

	€		
45 x 445 x 543 mm	254,87	1	FF1A143

SQZ150003

FS-8

SQZ150003-SBL















MTB-5-25	
481-400	
3734-2, 3734-3, 3734-4, 3734-5, 3734-6, 3734-8	
3735-5-120	
3740-175	
319	
208	
3625N-32	

FF1A145 - 20 piezas



FF1A145

	€		
38 x 445 x 543 mm	302,28	1	FF1A145















2628 G-180	
2430 G-160	
8224	 
2101G-160	
8045LVDE	
808050	
613-3-75	
611-4-100, 611-5-5-100, 611-6-5-150, 611-8-150, 611-6-5-25	
615-1-100, 615-2-125, 615-2-25	
1-100-08-1-2	
1-160-08-1-2	
1-170-08-2-2	
1-210-08-1-2	
1-230-08-1-2	

FF1A146 - 34 piezas



FF1A146

	€		
50 x 445 x 543 mm	616,41	1	FF1A146











2628 G-180	
2430 G-160	
8224	 
2101G-160	
FS-8	
7800SM-8, 7800SM-9, 7800SM-10, 7800SM-11, 7800SM-12, 7800SM-13, 7800SM-14, 7800SM-15, 7800SM-16, 7800SM-17, 7800SM-18, 7800SM-19, 7800SM-21, 7800SM-22, 7800SM-23, 7800SM-24, 7800SM-27, 7800SM-30, 7800SM-32	
8150SL	
SBS87S, SBS87	
8160-3, 8160-5, 8160-10	
8166	
8154-11	
8171	
8172	

FF1A147 - 16 piezas



FF1A147

	€		
40 x 445 x 543 mm	260,79	1	FF1A147













2951-250, 2951-180	
SQZ150003	
SQZ150003-SBL	
B191.030.075, B191.040.100	
B190.055.100, B190.065.125, B190.080.150	
B195.050.025	
B195.001.025	
B192.001.100, B192.002.125	
319	
208	
3625N-32	

FF1A15 - 12 piezas



FF1A15

	€		
40 x 445 x 543 mm	768,30	1	FF1A15

2101GC-125IP, 2101GC-160IP	
2233D-240IP	
2421GC-180IP	
2427 GC-200IP	
2430 GC-200 IP	
2628 GC-160IP	
2650	 
2855, 2855 D	 
2951-180	
8224CIP	 

FF1A153, 94 piezas



FF1A153

	€		
335 x 445 x 543 mm	354,11	1	FF1A153

S87+7	
-------	---



FF1A154, 13 piezas



FF1A154

	€		
37 x 445 x 543 mm	183,32	1	FF1A154

2171G-160	
224 D	
2470 G-160	
317	
3625W-28	
3733-4	
3734-3, 3734-6	
3735-5-120	
481-400	
KB18-01	
KSBG18-10DISPEN	
2678 G-180	

FF1A16 - 18 piezas



FF1A16

	€		
40 x 445 x 543 mm	560,41	1	FF1A16

KE18-01	
1150-1/2H/P	
MTB-3-16	
1177-SCRIBE	
1544	
2509	
2535F2	
2632	
268	
2744	

2820EF2

3525HB

5471 F-145

5515T

5515T-52

5516

BFLA01

SR300-E

FF1A164, 50 piezas



FF1A164

	€		
40 x 445 x 543 mm	565,86	1	FF1A164

1RM-10, 1RM-11, 1RM-12, 1RM-13, 1RM-14, 1RM-15, 1RM-16, 1RM-17, 1RM-18, 1RM-19, 1RM-8	
2058-BR	
S330	
111M-24, 111M-21, 111M-27, 111M-32	

FF1A165, 177 piezas



FF1A165

	€		
40 x 445 x 543 mm	320,82	1	FF1A165

59/S100B-T	
BE5049	
S1214L	
S1612L	
SBS87	
7402GPR-16	

FF1A167, 23 piezas



FF1A167

	€		
45 x 445 x 543 mm	330,50	1	FF1A167

1178-SCRIBE	
1419-MD	
2101G-160IP	
2430 G-190HD	
2628 G-180IP	
2744	
2953-250	
8224	
9031	
BE-9770	
BWSS12P317, BWSS12P319, BWSS12P321	
CR B 02	
2530	



FF1A168, 36 piezas



FF1A168



	€		
40 x 445 x 543 mm	219,99	1	FF1A168











1-100-08-2-2	
1-210-08-2-2	
1-230-08-2-2	
2485	
2487	
319	
268	
3740-100, 3740-150	
5515T	
782-U	

7865	
KB18-01	
KSBG18-10DISPEN	

FF1A169, 13 piezas 







FF1A169		€		
35 x 445 x 543 mm	271,48	1	FF1A169	

2681	
3625W-28	
3733-4	
3734-3, 3734-4, 3734-6	
3735-5-120	
481-400	
BB10	
BE66152	
BT10P330	
MA321	
MTB-3-16	

FF1A170- 14 piezas 









FF1A170		€		
40 x 445 x 543 mm	286,44	1	FF1A170	

28M-16, 28M-15, 28M-18, 28M-17, 28M-12, 28M-11, 28M-14, 28M-13, 28M-24, 28M-19, 28M-22, 28M-8, 28M-10, 28M-9	
--	---

FF1A18 - 26 piezas 





FF1A18		€		
44 x 445 x 543 mm	324,00	1	FF1A18	











1-476-04-3-2	
2633/S4	
3734S/6	
3736S/6	
481-200, 481-500	
782-U	
3625N-32	

Foam Fit&Go 3/3 con htas. para golpeo, corte y alicates -14 piezas 

FF1A185 

















FF1A185		€		
40 x 445 x 543 mm	180,25	1	FF1A185	

3734S/6-T	
479-16	
3625W-35	
KB18-01	
KSBG18-10DISPEN	
2101G-180IP	
2470 G-200	
2678 G-180	
8224 IP	
2530	

Incluye 25 piezas 









FF1A189		€		
40 x 445 x 543 mm	234,88	1	FF1A189	

3734S/6	
479-16	
3625W-35	
MTG-3-16	
KB18-01	
KSBG18-10DISPEN	
2101G-180IPD	
2630GC-180IP	
2470 G-200	
8224 IP	
2530	

FF1A19 - 33 piezas 



FF1A19		€		
50 x 543 x 445 mm	453,17	1	FF1A19	

111M-30, 111M-32, 111M-6, 111M-7, 111M-8, 111M-9, 111M-10, 111M-11, 111M-12, 111M-13, 111M-14, 111M-15, 111M-16, 111M-17, 111M-18, 111M-19, 111M-20, 111M-21, 111M-22, 111M-24, 111M-27	
6M-6-7, 6M-8-9, 6M-10-11, 6M-12-13, 6M-14-15, 6M-16-17, 6M-18-19, 6M-20-22, 6M-21-23, 6M-24-27, 6M-30-32	
92C	



Incluye 51 piezas



FF1A194

	€		
40 x 445 x 543 mm	676,01	1	FF1A194

6968	
6700SM-14, 6700SM-13, 6700SM-12, 6700SM-11, 6700SM-10, 6700SM-9, 6700SM-8, 6700SM-7, 6700SM-6, 6700SM-5, 6700SM-4	
6709M-3, 6709M-8, 6709M-6, 6709M-5, 6709M-4	
6950SL	
7800SM-24, 7800SM-23, 7800SM-22, 7800SM-13, 7800SM-12, 7800SM-11, 7800SM-10, 7800SM-9, 7800SM-8, 7800SM-21, 7800SM-19, 7800SM-18, 7800SM-17, 7800SM-16, 7800SM-15, 7800SM-14	
7809M-8, 7809M-7, 7809M-10, 7809M-6, 7809M-5	
7809TORX-T20, 7809TORX-T25, 7809TORX-T30, 7809TORX-T40	
7455-200	
8150SL	
8168	
K6650-1/4-1P	
6960W-2, 6960W-6	
8160-10, 8160-5	

FF1A20 - 18 piezas



FF1A20

	€		
50 x 445 x 543 mm	509,67	1	FF1A20

2M-6-7, 2M-8-9, 2M-10-11, 2M-12-13, 2M-14-15, 2M-16-17, 2M-18-19, 2M-20-22, 2M-21-23, 2M-24-27, 2M-30-32		
4040M-10-11, 4040M-12-13, 4040M-14-15, 4040M-16-17, 4040M-18-19, 4040M-21-23		
2953-250		

FF1A22 - 58 piezas



FF1A22

	€		
50 x 445 x 543 mm	837,70	1	FF1A22

7800SM-10, 7800SM-12, 7800SM-13, 7800SM-14, 7800SM-16, 7800SM-17, 7800SM-18, 7800SM-19, 7800SM-21, 7800SM-22, 7800SM-23, 7800SM-24, 7800SM-27, 7800SM-30, 7800SM-32		
7805SM-13, 7805SM-16, 7805SM-17, 7805SM-18, 7805SM-19, 7805SM-21, 7805SM-22, 7805SM-24, 7805SM-27, 7805SM-30, 7805SM-32		
7809M-5, 7809M-6, 7809M-8, 7809M-10, 7809M-12, 7809M-14		
8150SL		
6700SM-4, 6700SM-4.5, 6700SM-5, 6700SM-5.5, 6700SM-6, 6700SM-7, 6700SM-8, 6700SM-9, 6700SM-10, 6700SM-11, 6700SM-12, 6700SM-13		
6958		
6954		
6960, 6962		
6966		
6950SL		
4532-A		
8157-15		
8154-11		
8160-3, 8160-5		
8166		

FF1A23 - 21 piezas



FF1A23

	€		
40 x 445 x 543 mm	464,30	1	FF1A23

3735-4-120	
3734-2, 3734-3, 3734-4, 3734-5, 3734-6, 3734-8	
2630GC-180IP	
2430 GC-200 IP	
2427 GC-200IP	
2900-180	
2890-180	
2990-180	
2800-180	
7224	
2101GC-160IP	
479-16	
1547	
MTB-3-16	
SC127	
3625N-32	

Incluye 17 piezas



FF1A230

	€		
40 x 445 x 543 mm	510,82	1	FF1A230

1RM-9, 1RM-8, 1RM-11, 1RM-10, 1RM-13, 1RM-12, 1RM-15, 1RM-14, 1RM-17, 1RM-16, 1RM-19, 1RM-18		
28-29/S4		
8072 C		

FF1A2301 - 26 piezas



FF1A2301

	€		
70 x 445 x 543 mm	799,75	1	FF1A2301

8900DM-19, 8900DM-22, 8900DM-23, 8900DM-24, 8900DM-25, 8900DM-26, 8900DM-27, 8900DM-28, 8900DM-29, 8900DM-30, 8900DM-32, 8900DM-33, 8900DM-34, 8900DM-36, 8900DM-41, 8900DM-46, 8900DM-50, 8900DM-55, 8900DM-60		
8954		
8954A		
8958A		
8961		
8965		
8966		
8955N/B		

Foam 3/3 Fut&Go para ai



FF1A235

	kg	€		
50 x 445 x 543 mm	4.10 kg	430,73	1	FF1A235

BE61110	
BE621702, BE621703, BE621701, BE621706, BE621707, BE621704, BE621705, BE621710, BE621711, BE621708, BE621709, BE621714, BE621715, BE621712, BE621713, BE621716, BE621717	
BE6810	
2M-6-7, 2M-8-9, 2M-12-13, 2M-18-19, 2M-16-17, 2M-10-11, 2M-14-15, 2M-24-26, 2M-21-23, 2M-27-29, 2M-20-22, 2M-30-32	

Foam Fit & Go 3/3 para carrocería de automoción - 13 piezas



FF1A236

	kg	€		
55 x 445 x 543 mm	9.5 kg	453,20	1	FF1A236

3-330-14-2-0		
9-462-14-0-0		
1467-250		
BBSH2F		
BBSH2CA		
BBSDW		
BBSDA		
BBSDT		
BBSDH		
BBSDC		
BBSDHR		
BBSS1		
2485		

FF1A24 - 19 piezas



FF1A24

	€		
45 x 445 x 543 mm	411,12	1	FF1A24

3735-4-120	
3734-2, 3734-3, 3734-4, 3734-5, 3734-6, 3734-8	
2630GC-180IP	

2430 GC-200 IP	
2900-180	
2890-180	
2990-180	
2800-180	
7224	
2101GC-160IP	
479-16	
3625N-32	
MTB-3-16	
SC127	

FF1A25 - 50 piezas



FF1A25

	€		
50 x 445 x 543 mm	649,66	1	FF1A25

7800SM-10, 7800SM-12, 7800SM-13, 7800SM-14, 7800SM-15, 7800SM-16, 7800SM-17, 7800SM-18, 7800SM-19, 7800SM-21, 7800SM-22, 7800SM-23, 7800SM-24, 7800SM-27, 7800SM-30, 7800SM-32		
7805SM-13, 7805SM-16, 7805SM-17, 7805SM-18, 7805SM-19, 7805SM-21, 7805SM-22, 7805SM-24, 7805SM-27, 7805SM-30, 7805SM-32		
8150SL		
6700SM-4, 6700SM-4.5, 6700SM-5, 6700SM-5.5, 6700SM-6, 6700SM-7, 6700SM-8, 6700SM-9, 6700SM-10, 6700SM-11, 6700SM-12, 6700SM-13		
6954		
6960, 6962		
6966		
6950SL		
2953-250		
8166		
8154-11		
8160-3, 8160-5		



FF1A2501 - 83 piezas



FF1A2501



	€		
50 x 445 x 543 mm	976,78	1	FF1A2501

6700SM-4, 6700SM-5, 6700SM-5.5, 6700SM-6, 6700SM-7, 6700SM-8, 6700SM-9, 6700SM-10, 6700SM-11, 6700SM-12, 6700SM-13		
6700TORX-E8, 6700TORX-E10		
6709M-3, 6709M-4, 6709M-5, 6709M-6, 6709M-8		
6709TORX-T8, 6709TORX-T10, 6709TORX-T15, 6709TORX-T20, 6709TORX-T25, 6709TORX-T27, 6709TORX-T30, 6709TORX-T40		
6950SL		
6954		
6956		
6962		
6966		
7400SM-8, 7400SM-9, 7400SM-10, 7400SM-11, 7400SM-12, 7400SM-13, 7400SM-14, 7400SM-15, 7400SM-16, 7400SM-17, 7400SM-18, 7400SM-19, 7400SM-20, 7400SM-21, 7400SM-22		
7400TORX-E8, 7400TORX-E10, 7400TORX-E12, 7400TORX-E14		
7750SL		
7754		
7762		
7764		
7765		
7766		
7768		
7800SM-13, 7800SM-17, 7800SM-12, 7800SM-18, 7800SM-19, 7800SM-20, 7800SM-27, 7800SM-30, 7800SM-32, 7800SM-21, 7800SM-22, 7800SM-24		
7809M-12, 7809M-10		
7809TORX-T20, 7809TORX-T25, 7809TORX-T40, 7809TORX-T50, 7809TORX-T55		
8150SL		
8164-1/2		
8154-11		
8160-10		
8171		
8166		
8172		

FF1A2503 - 101 piezas



FF1A2503



	€		
55 x 445 x 543 mm	681,61	1	FF1A2503

6700SM-4.5, 6700SM-4, 6700SM-5, 6700SM-5.5, 6700SM-6, 6700SM-7, 6700SM-8, 6700SM-9, 6700SM-10, 6700SM-11, 6700SM-12, 6700SM-13, 6700SM-14		
7800SM-10, 7800SM-11, 7800SM-12, 7800SM-13, 7800SM-14, 7800SM-15, 7800SM-18, 7800SM-19, 7800SM-21, 7800SM-22, 7800SM-23, 7800SM-24, 7800SM-30, 7800SM-26, 7800SM-27, 7800SM-28, 7800SM-32, 7800SM-16, 7800SM-17, 7800SM-8, 7800SM-9		
BE-9678		
7809M-10, 7809M-12, 7809M-14, 7809M-17, 7809M-19, 7809M-5, 7809M-7, 7809M-8, 7809M-9, 7809M-6		
59S/31-1		
7809M-10-140, 7809M-5-180, 7809M-6-140, 7809M-7-100, 7809M-8-120		
808050		
8155-1/2		
6950		
6954		
6956		
6960, 6962		
6966		
8154-11		
8160-5, 8160-10		
8166		

FF1A26 - 27 piezas



FF1A26



	€		
50 x 445 x 543 mm	469,64	1	FF1A26

111M-30, 111M-32, 111M-6, 111M-7, 111M-8, 111M-9, 111M-10, 111M-11, 111M-12, 111M-13, 111M-14, 111M-15, 111M-16, 111M-17, 111M-18, 111M-19, 111M-20, 111M-21, 111M-22, 111M-24, 111M-27		
2630GC-180IP		
2430 GC-200 IP		
7224		
2953-250		
2101GC-160IP		
SC127		

FF1A28 - 48 piezas



FF1A28



	€		
50 x 445 x 543 mm	550,46	1	FF1A28

7800SM-18, 7800SM-19, 7800SM-21, 7800SM-22, 7800SM-23, 7800SM-24, 7800SM-27, 7800SM-30, 7800SM-32, 7800SM-10, 7800SM-12, 7800SM-13, 7800SM-14, 7800SM-15, 7800SM-16, 7800SM-17		
8150SL		
6700SM-4.5, 6700SM-5, 6700SM-5.5, 6700SM-6, 6700SM-7, 6700SM-8, 6700SM-9, 6700SM-10, 6700SM-11, 6700SM-12, 6700SM-13, 6700SM-4		
6954		
6960, 6962		
6966		
6950SL		
3735-4-120		
3734-2, 3734-3, 3734-4, 3734-5, 3734-6, 3734-8		
479-16		
MTB-3-16		
3625N-32		
8154-11		
8160-3, 8160-5		
8166		

Llaves, alicates y vasos en bandeja de foam 3/3 Fit&Go con marcado láser (45 piezas)



FF1A29NB

		€		
50 x 445 x 543 mm	6.26 kg	315,27	1	FF1A29NB

111M-6, 111M-7, 111M-8, 111M-9, 111M-13, 111M-12, 111M-11, 111M-10, 111M-24, 111M-22, 111M-17, 111M-16, 111M-15, 111M-14, 111M-21, 111M-19, 111M-18

8071 IP

2470 G-160

2971G-250

2171G-160

8150SL

SBS83-10, SBS83-5

SBS87S

SBS85

SP16SLH

7800SM-27, 7800SM-22, 7800SM-23, 7800SM-24, 7800SM-18, 7800SM-19, 7800SM-20, 7800SM-21, 7800SM-14, 7800SM-15, 7800SM-16, 7800SM-17, 7800SM-10, 7800SM-11, 7800SM-12, 7800SM-13, 7800SM-30, 7800SM-32

FF1A3001 - 21 piezas



FF1A3001

	€		
40 x 445 x 543 mm	273,92	1	FF1A3001

111M-32, 111M-30, 111M-24, 111M-22, 111M-27, 111M-17, 111M-16, 111M-15, 111M-14, 111M-21, 111M-20, 111M-19, 111M-18, 111M-9, 111M-8, 111M-7, 111M-6, 111M-13, 111M-12, 111M-11, 111M-10

FF1A3002 - 7 piezas



FF1A3002

	€		
35 x 445 x 543 mm	347,33	1	FF1A3002

1RM-24, 1RM-22, 1RM-21, 1RM-19, 1RM-32, 1RM-30, 1RM-27

FF1A3003 - 28 piezas



FF1A3003

	€		
40 x 445 x 543 mm	307,69	1	FF1A3003

1952M-27, 1952M-21, 1952M-20, 1952M-19, 1952M-18, 1952M-24, 1952M-22, 1952M-13, 1952M-12, 1952M-11, 1952M-10, 1952M-17, 1952M-16, 1952M-15, 1952M-14, 1952M-9, 1952M-8, 1952M-7, 1952M-6

BE-9778

FF1A3004 - 30 piezas



FF1A3004

	€		
48 x 445 x 543 mm	535,81	1	FF1A3004

111M-24, 111M-22, 111M-17, 111M-16, 111M-15, 111M-14, 111M-21, 111M-20, 111M-19, 111M-18, 111M-9, 111M-8, 111M-7, 111M-6, 111M-13, 111M-12, 111M-11, 111M-10

1RM-19, 1RM-10, 1RM-9, 1RM-8, 1RM-14, 1RM-13, 1RM-12, 1RM-11, 1RM-18, 1RM-17, 1RM-16, 1RM-15



FF1A3005 - 28 piezas



FF1A3005

	€		
38 x 445 x 543 mm	569,00	1	FF1A3005

1952M-19, 1952M-18, 1952M-22, 1952M-13, 1952M-12, 1952M-11, 1952M-10, 1952M-17, 1952M-16, 1952M-15, 1952M-14, 1952M-9, 1952M-8, 1952M-7, 1952M-6

1RM-6, 1RM-10, 1RM-9, 1RM-8, 1RM-7, 1RM-24, 1RM-22, 1RM-19, 1RM-14, 1RM-13, 1RM-12, 1RM-11, 1RM-17

Juego de destornilladores, carraca, vasos y puntas en bandeja de foam 3/3 Fit&Go con marcado láser (22 piezas)



FF1A30NB

		€		
35 x 445 x 543 mm	2.8 kg	219,56	1	FF1A30NB

BE-8020, BE-8030, BE-8040

BE-8150, BE-8155

BE-8160

BE-8611, BE-8621

BE-8811, BE-8821

BE-8910, BE-8915, BE-8920, BE-8925, BE-8930

808050S

808050

6972H

K6650-1/4-1P

6950SL

59S/31-1

SBS64

SB6963

SBS60-4, SBS60-11, SBS60-12, SBS60-13, SBS60-7, SBS60-8, SBS60-9, SBS60-10, SBS60-4.5, SBS60-5, SBS60-5.5, SBS60-6



Juego de herramientas de golpeo y corte, limas y llaves acodadas en bandeja de foam 3/3 Fit&Go con marcado láser (28 piezas)



FF1A31NB

45 x 445 x 543 mm 2.69 kg 123,89 € 1 FF1A31NB

317	
1-100-08-1-2	
1-210-08-1-2	
1-230-08-1-2	
MTB-3-16	
3625W-35	
481-300	
782-U	
BE-9770	
KG09-01	
KSBG09-10DISPEN	

FF1A35 - 24 piezas



FF1A35

42 x 445 x 543 mm 365,92 € 1 FF1A35

317	
1-100-08-1-2	
1-210-08-1-2	
1-230-08-1-2	
MTB-3-16	
3625W-35	
481-300	
782-U	
BE-9770	
KG09-01	
4040M-8-9, 4040M-10-11, 4040M-12-13, 4040M-14-15, 4040M-16-17	

FF1A36 - 89 piezas



FF1A36

50 x 445 x 543 mm 483,95 € 1 FF1A36

4040M-8-9, 4040M-10-11, 4040M-12-13, 4040M-14-15, 4040M-16-17	
808050S	
808050	
6972H	
K6650-1/4-1P, 59S/H8	
6950SL	
59S/31-1	
59S/H2, 59S/H3, 59S/H4, 59S/H5, 59S/H6	
8030-2P, 8040-2P, 8242-2P, 8252-2P	
8610-2P, 8620-2P, 8630-2P	
8810-2P, 8820-2P, 8830-2P	
8910-2P, 8915-2P, 8925-2P, 8930-2P, 8940-2P	
BE-8575	
SBS60-11, SBS60-12, SBS60-13, SBS60-4, SBS60-4.5, SBS60-5, SBS60-5.5, SBS60-6, SBS60-7, SBS60-8, SBS60-9, SBS60-10	
SB6963	
SBS64	

FF1A37 - 46 piezas



FF1A37

35 x 445 x 543 mm 352,93 € 1 FF1A37

111M-6, 111M-7, 111M-8, 111M-9, 111M-10, 111M-11, 111M-12, 111M-13, 111M-14, 111M-15, 111M-16, 111M-17, 111M-18, 111M-19, 111M-21, 111M-22, 111M-24	
8071 IP	
2101G-160	
2430 G-160	
8224	
S240NB-NR	
8150SL	

FF1A39 - 54 piezas



FF1A39

45 x 445 x 543 mm 299,81 € 1 FF1A39

S410	
S1612L	
8071 IP	

FF1A4001 - 12 piezas



FF1A4001

38 x 445 x 543 mm 432,70 € 1 FF1A4001

1520 D	
2101G-160IP	
21HDG-200IP	
2223 G-150	

2421 G-140IP, 2421 G-180 IP	
2427 G-200 IP	
2628 G-180IP	
2681	
2951-140, 2951-300	
8224 IP	

FF1A4002 - 11 piezas



FF1A4002

	€		
42 x 445 x 543 mm	388,55	1	FF1A4002

2101G-160IP	
2430 G-200 IP	
2465D-200	
2628 G-160IP	
2744	
2951-140	
2952-165	
1520 G	
527 D-160	
7224	
5515FL	

FF1A4003 - 12 piezas



FF1A4003

	€		
35 x 445 x 543 mm	316,48	1	FF1A4003

2800-150, 2800-180, 2800-225	
2890-140, 2890-180, 2890-210	
2900-150, 2900-180, 2900-215	
2990-140, 2990-180, 2990-200	

FF1A41- 9 piezas



FF1A41

	€		
42 x 445 x 543 mm	138,11	1	FF1A41

2171G-160	
2470 G-160	
2971G-250	
MTB-3-16	
WR2-12	
3625W-35	
481-300	
218	
306	

Llaves, 31 piezas



FF1A48

	€		
44 x 543 x 445 mm	371,53	1	FF1A48

1RM-6, 1RM-7, 1RM-8, 1RM-9, 1RM-10, 1RM-11, 1RM-12, 1RM-13, 1RM-14, 1RM-17, 1RM-19, 1RM-22, 1RM-24, 1RM-27	
111M-6, 111M-7, 111M-8, 111M-9, 111M-10, 111M-11, 111M-12, 111M-13, 111M-14, 111M-15, 111M-16, 111M-17, 111M-18, 111M-19, 111M-20, 111M-21, 111M-22	

FF1A50 - 13 piezas



FF1A50

	€		
45 x 445 x 543 mm	529,17	1	FF1A50

8223 IP, 8224 IP, 8225 IP	
1420	
2430 G-160 IP	
2427 G-160 IP	
8069	
9070	
9031	
2101G-160IP	
21HDG-180IP	

FF1A5002 - 27 piezas



FF1A5002

	€		
50 x 445 x 543 mm	327,41	1	FF1A5002

111M-30, 111M-32, 111M-6, 111M-7, 111M-8, 111M-9, 111M-10, 111M-11, 111M-12, 111M-13, 111M-14, 111M-15, 111M-16, 111M-17, 111M-18, 111M-19, 111M-20, 111M-21, 111M-22, 111M-24, 111M-27	
3734S/6	



FF1A5003 - 91 piezas



FF1A5003

	€		
45 x 445 x 543 mm	1.033,05	1	FF1A5003

111M-13, 111M-12, 111M-10, 111M-8, 111M-19, 111M-17, 111M-15	
6700SM-5.5, 6700SM-5, 6700SM-14, 6700SM-13, 6700SM-12, 6700SM-11, 6700SM-10, 6700SM-9, 6700SM-8, 6700SM-7, 6700SM-6	
6700TORX-E5, 6700TORX-E4, 6700TORX-E10, 6700TORX-E8, 6700TORX-E7, 6700TORX-E6	
6709TORX-T27, 6709TORX-T25, 6709TORX-T20, 6709TORX-T15, 6709TORX-T10, 6709TORX-T9, 6709TORX-T8, 6709TORX-T40, 6709TORX-T30	
6950	
6961, 6962	
6966	
7400SM-13, 7400SM-12, 7400SM-11, 7400SM-10, 7400SM-9, 7400SM-8, 7400SM-21, 7400SM-19, 7400SM-18, 7400SM-17, 7400SM-16, 7400SM-15, 7400SM-14, 7400SM-22	
7400TORX-E18, 7400TORX-E16, 7400TORX-E14, 7400TORX-E12, 7400TORX-E11, 7400TORX-E10, 7400TORX-E8	
7409TORX-T30, 7409TORX-T27, 7409TORX-T25, 7409TORX-T50, 7409TORX-T45, 7409TORX-T40	
7750	
7760, 7761, 7762	
7764	
7765	
7766	
A6800DM-8, A6800DM-7, A6800DM-6, A6800DM-14, A6800DM-13, A6800DM-12, A6800DM-11, A6800DM-10, A6800DM-9	
A7402DM-19, A7402DM-18, A7402DM-17, A7402DM-16, A7402DM-15, A7402DM-14, A7402DM-13, A7402DM-12, A7402DM-11, A7402DM-10	
8157-15	

FF1A5004 - 37 piezas



FF1A5004

	€		
55 x 445 x 543 mm	734,96	1	FF1A5004

1RM-19, 1RM-13, 1RM-12, 1RM-11, 1RM-10, 1RM-9, 1RM-8, 1RM-27, 1RM-7, 1RM-24, 1RM-6, 1RM-22, 1RM-17	
6700SM-13, 6700SM-12, 6700SM-11, 6700SM-10, 6700SM-9, 6700SM-8, 6700SM-7, 6700SM-6	
6950	
6960	
6966	
7800SM-19, 7800SM-17, 7800SM-32, 7800SM-30, 7800SM-13, 7800SM-27, 7800SM-24, 7800SM-22	
8155-1/2	
SBS86	
6954	
8160-5	
8166	

FF1A5005 - 83 piezas



FF1A5005

	€		
50 x 445 x 543 mm	1.019,46	1	FF1A5005

111M-17, 111M-15, 111M-13, 111M-19, 111M-8	
6700SM-8, 6700SM-7, 6700SM-6, 6700SM-12, 6700SM-11, 6700SM-10, 6700SM-9, 6700SM-14, 6700SM-13, 6700SM-5, 6700SM-4	
6709M-5, 6709M-4, 6709M-8, 6709M-6, 6709M-3	

6950SL	
6962	
6968	
7400SM-8, 7400SM-7, 7400SM-6, 7400SM-12, 7400SM-11, 7400SM-10, 7400SM-9, 7400SM-16, 7400SM-15, 7400SM-14, 7400SM-13, 7400SM-18, 7400SM-17	
7750SL	
7760-W	
7761	
7768	
7800SM-11, 7800SM-10, 7800SM-15, 7800SM-14, 7800SM-13, 7800SM-12, 7800SM-19, 7800SM-18, 7800SM-17, 7800SM-16, 7800SM-22, 7800SM-21, 7800SM-27, 7800SM-24, 7800SM-32, 7800SM-30, 7800SM-8, 7800SM-9	
7809M-17, 7809M-14, 7809M-12, 7809M-10, 7809M-5, 7809M-6, 7809M-7, 7809M-8	
7809TORX-T40, 7809TORX-T30, 7809TORX-T25, 7809TORX-T20, 7809TORX-T45	
8150SL	
A6709M-6, A6709M-5, A6709M-4, A6709M-3, A6709M-2.5	
K6650-1/4-1P	
6960W-2, 6960W-6	
8160-5, 8160-10	
8166	

FF1A5006 - 27 piezas



FF1A5006

	€		
54 x 445 x 543 mm	496,69	1	FF1A5006

1-100-08-2-2	
1-210-08-2-2	
1-230-06-2-2, 1-230-10-2-2	
111M-7, 111M-8, 111M-9, 111M-10, 111M-11, 111M-12, 111M-13, 111M-14, 111M-15, 111M-16, 111M-17, 111M-18, 111M-19, 111M-21, 111M-22	
1320RM-6-7, 1320RM-8-9, 1320RM-10-11, 1320RM-12-13, 1320RM-14-15, 1320RM-16-17, 1320RM-18-19, 1320RM-22-24	

FF1A5007 - 60 piezas



FF1A5007

	€		
50 x 445 x 543 mm	746,21	1	FF1A5007

K6650-1/4-1P	
3734-2, 3734-3, 3734-4, 3734-5, 3734-6, 3734-8	
481-400	
6700SM-11, 6700SM-12, 6700SM-13, 6700SM-14, 6700SM-10, 6700SM-5, 6700SM-6, 6700SM-7, 6700SM-8, 6700SM-9, 6700SM-4	
6709F-8, 6709F-5.5	
6709M-3, 6709M-4, 6709M-5, 6709M-6	
6709PH-1, 6709PH-2	
6950SL	
6954	
6960, 6962	
6966	
7800SM-18, 7800SM-19, 7800SM-10, 7800SM-11, 7800SM-12, 7800SM-13, 7800SM-14, 7800SM-15, 7800SM-16, 7800SM-17, 7800SM-21, 7800SM-22, 7800SM-23, 7800SM-24, 7800SM-25, 7800SM-26, 7800SM-27, 7800SM-28, 7800SM-30, 7800SM-32	
8072 IP	
B145.006.100	
8150SL	
8224 IP	
8154-11	
8160-5, 8160-10	
8166	

FF1A5008 - 24 piezas



FF1A5008

	€		
50 x 445 x 543 mm	548,85	1	FF1A5008

1-100-08-2-2	
1-160-08-2-2	

1-170-08-2-2	
1-210-08-2-2	
1-230-08-2-2	
1150D	
1450D-ISO	
1547	
3625N-40	
3734-2, 3734-3, 3734-4, 3734-5, 3734-6, 3734-8	
3735-4-120, 3735-5-150	
3740-125, 3740-150	
38-20	
5515T	
9029, 9031	
MTB-3-16	

FF1A5009 - 17 piezas



FF1A5009

	€		
38 x 445 x 543 mm	484,84	1	FF1A5009

2101S-160		1000 V REC0000
2223 S-150		1000 V REC0000
2250V-170		1000 V REC0000
2430 S-200		1000 V REC0000
2628 S-180		1000 V REC0000
8072V		1000 V REC0000
BE-8220S, BE-8040S, BE-8050S, BE-8255S, BE-8065S		
BE-8340		
BE-8601		
BE-8610S, BE-8620S		
BE-8810S, BE-8820S		

FF1A5010 - 22 piezas



FF1A5010

	€		
35 x 445 x 543 mm	348,10	1	FF1A5010

1-100-08-1-2	
1-160-08-1-2	
1-170-08-2-2	
1-210-08-1-2	
1-230-08-1-2	
2101G-180IP	
2427 G-200 IP	
2430 G-200 IP	
2628 G-180IP	
3733-2, 3733-4, 3733-6	
3734-2, 3734-3, 3734-4, 3734-5, 3734-6, 3734-8	
3735-4-120	
481-300	
8069 IP	
9031	

FF1A5011 - 27 piezas



FF1A5011

	€		
44 x 445 x 543 mm	349,69	1	FF1A5011

1-476-04-3-2	
1178-SCRIBE	
1547	
2101G-160IP	
2427 G-160 IP	
2430 G-160 IP	
3734-2, 3734-3, 3734-4, 3734-5, 3734-6, 3734-8	
3735-5-120	
481-500	
BE-8020L, BE-8040	
BE-8150, BE-8255, BE-8256	
BE-8610, BE-8620	
MTB-3-16	



FF1A5012 - 13 piezas



FF1A5012

48 x 445 x 543 mm € 270,27 1 FF1A5012

- 141
- 3734-2, 3734-3, 3734-4, 3734-5, 3734-6
- 479-08
- 481-1000, 481-300
- 782-U
- MTS-5-25
- SQZ150003
- 319

FF1A5013 - 41 piezas



FF1A5013

50 x 445 x 543 mm € 538,18 1 FF1A5013

- 111M-6, 111M-7, 111M-8, 111M-9, 111M-12, 111M-13, 111M-17, 111M-10, 111M-11, 111M-19, 111M-20, 111M-22, 111M-24, 111M-27, 111M-32, 111M-30
- 6700SM-6, 6700SM-7, 6700SM-8, 6700SM-9, 6700SM-10, 6700SM-11, 6700SM-12, 6700SM-13, 6700SM-14
- 6950
- 6960
- 6966
- 7800SM-19, 7800SM-17, 7800SM-13, 7800SM-22, 7800SM-27, 7800SM-24, 7800SM-30, 7800SM-32
- 8155-1/2
- SBS86
- 6954
- 8160-5
- 8166

FF1A5015 - 17 piezas



FF1A5015

45 x 445 x 543 mm € 237,08 1 FF1A5015

- 319
- 268
- 208
- 2509
- 2444
- 2744
- 5515T
- BE-8020L, BE-8040
- BE-8150, BE-8255, BE-8256
- BE-8340
- BE-8601
- BE-8610, BE-8620
- MTB-5-25

FF1A5017 - 16 piezas



FF1A5017

35 x 445 x 543 mm € 233,63 1 FF1A5017

- 3734-2, 3734-3, 3734-4, 3734-5, 3734-6, 3734-8
- 3735-5-120
- 3740-175
- 481-400
- 111M-21, 111M-22, 111M-24, 111M-27, 111M-32, 111M-30
- 3625N-32

FF1A5019 - 47 piezas



FF1A5019

52 x 445 x 543 mm € 592,70 1 FF1A5019

- 111M-17, 111M-18, 111M-19, 111M-20, 111M-6, 111M-7, 111M-8, 111M-13, 111M-14, 111M-15, 111M-16, 111M-9, 111M-10, 111M-11, 111M-12
- 2101G-160IP
- 2430 G-160 IP
- 2628 G-180IP
- 7800DM-12, 7800DM-13, 7800DM-14, 7800DM-15, 7800DM-10, 7800DM-11, 7800DM-20, 7800DM-21, 7800DM-22, 7800DM-23, 7800DM-16, 7800DM-17, 7800DM-18, 7800DM-19, 7800DM-28, 7800DM-30, 7800DM-32, 7800DM-24, 7800DM-25, 7800DM-26, 7800DM-27, 7800DM-8, 7800DM-9
- 8155-1/2
- 8224 IP
- 8154-11
- 8160-5, 8160-10
- 8166

FF1A5021 - 17 piezas



FF1A5021

45 x 445 x 543 mm € 293,28 1 FF1A5021

BE-8020L, BE-8040		
BE-8150, BE-8255, BE-8256		
BE-8340		
BE-8601		
BE-8610, BE-8620		
319		
MTB-5-25		
2444		
268		
5515T		
2509		
2744		
208		

FF1A5022 - 26 piezas



FF1A5022

50 x 445 x 543 mm € 1 FF1A5022 416,54

6700SM-4.5, 6700SM-5, 6700SM-5.5, 6700SM-6, 6700SM-7, 6700SM-8, 6700SM-9, 6700SM-10, 6700SM-11, 6700SM-12, 6700SM-13, 6700SM-14, 6700SM-4		
6950		
6954		
6956		
6960, 6962		
6966		
8070		
9031		
9072 P		
141		
2101G-160IP		
2430 G-160 IP		
2628 G-180IP		
8224 IP		

FF1A5023 - 16 piezas



FF1A5023

45 x 445 x 543 mm € 1 FF1A5023 274,87

208		
2444		
2509		
268		
2744		
319		
5515T		
BE-8020L, BE-8040		
BE-8150, BE-8255, BE-8256		
BE-8340		
BE-8601		
BE-8610, BE-8620		

FF1A5024 - 28 piezas



FF1A5024

45 x 445 x 543 mm € 1 FF1A5024 635,55

111M-12, 111M-13, 111M-6, 111M-7, 111M-8, 111M-9, 111M-10, 111M-11		
1RM-17, 1RM-18, 1RM-19, 1RM-8, 1RM-9, 1RM-10, 1RM-11, 1RM-12, 1RM-13, 1RM-14, 1RM-15, 1RM-16		
2101G-160IP		
2430 G-160 IP		
141		
2628 G-180IP		
9031		

9072 P

8070

8224 IP



FF1A5027 - 36 piezas



FF1A5027

44 x 445 x 543 mm € 1 FF1A5027 770,51

2M-20-22, 2M-21-23, 2M-24-27, 2M-25-28, 2M-30-32		
4040M-10-11, 4040M-12-13, 4040M-14-15, 4040M-16-17, 4040M-18-19, 4040M-20-22, 4040M-21-23, 4040M-8-9		
7400SM-6, 7400SM-7, 7400SM-12, 7400SM-13, 7400SM-14, 7400SM-15, 7400SM-8, 7400SM-9, 7400SM-10, 7400SM-11, 7400SM-20, 7400SM-21, 7400SM-22, 7400SM-16, 7400SM-17, 7400SM-18, 7400SM-19		
7754		
7755-3/8		
7760, 7761, 7762		
7766		

FF1A5028 - 33 piezas



FF1A5028

45 x 445 x 543 mm € 1 FF1A5028 266,72

111M-6, 111M-7, 111M-8, 111M-9, 111M-10, 111M-11, 111M-14, 111M-15, 111M-16, 111M-17, 111M-18, 111M-19, 111M-20, 111M-12, 111M-13		
1419-MD		
BE-8906, BE-8907, BE-8908, BE-8909, BE-8910, BE-8915, BE-8920, BE-8925, BE-8927, BE-8930, BE-8940, BE-8945		
7805DM-12, 7805DM-13, 7805DM-17, 7805DM-10, 7805DM-19		



FF1A5029 - 29 piezas



FF1A5029

	€		
40 x 445 x 543 mm	426,76	1	FF1A5029

2628 G-180IP	
2101G-160IP	
2430 G-160 IP	
8224 IP	
BBR201P6	
BE5103	
2M-10-11, 2M-12-13, 2M-14-15, 2M-16-17, 2M-18-19, 2M-6-7, 2M-8-9	
7809TORX-T50, 7809TORX-T55, 7809TORX-T25, 7809TORX-T30, 7809TORX-T40, 7809TORX-T45	

FF1A5030 - 45 piezas



FF1A5030

	€		
52 x 445 x 543 mm	563,07	1	FF1A5030

111M-17, 111M-18, 111M-19, 111M-20, 111M-6, 111M-7, 111M-8, 111M-13, 111M-14, 111M-15, 111M-16, 111M-9, 111M-10, 111M-11, 111M-12	
2951-180, 2951-250	
7800DM-12, 7800DM-13, 7800DM-14, 7800DM-15, 7800DM-8, 7800DM-9, 7800DM-10, 7800DM-11, 7800DM-20, 7800DM-21, 7800DM-22, 7800DM-23, 7800DM-16, 7800DM-17, 7800DM-18, 7800DM-19, 7800DM-28, 7800DM-30, 7800DM-32, 7800DM-24, 7800DM-26, 7800DM-27	
8155-1/2	
3625N-32	
8154-11	
8160-5, 8160-10	
8166	

FF1A5031 - 62 piezas



FF1A5031

	€		
48 x 445 x 543 mm	343,77	1	FF1A5031

1419-MD	
7809M-10, 7809M-12, 7809M-14, 7809M-17, 7809M-19, 7809M-7, 7809M-8, 7809M-5, 7809M-9, 7809M-6	
BE-9678	
7809M-10-140, 7809M-5-180, 7809M-6-140, 7809M-7-100, 7809M-8-120	
59S/31-1	
808050	
7805DM-12, 7805DM-13, 7805DM-17, 7805DM-19, 7805DM-10	

FF1A5032 - 76 piezas



FF1A5032

	€		
55 x 445 x 543 mm	675,68	1	FF1A5032

6700SM-10, 6700SM-11, 6700SM-8, 6700SM-9, 6700SM-14, 6700SM-12, 6700SM-13, 6700SM-4, 6700SM-6, 6700SM-7, 6700SM-5, 6700SM-4.5, 6700SM-5.5	
6950	
6954	
6956	
6960, 6962	
6966	
7400SM-6, 7400SM-7, 7400SM-10, 7400SM-11, 7400SM-8, 7400SM-9, 7400SM-14, 7400SM-15, 7400SM-12, 7400SM-13, 7400SM-18, 7400SM-19, 7400SM-16, 7400SM-17, 7400SM-22, 7400SM-20, 7400SM-21	
7754	

7755-3/8

7760, 7761, 7762

7766

7800DM-11, 7800DM-14, 7800DM-15, 7800DM-12, 7800DM-13, 7800DM-18, 7800DM-19, 7800DM-16, 7800DM-17, 7800DM-22, 7800DM-23, 7800DM-20, 7800DM-21, 7800DM-26, 7800DM-27, 7800DM-24, 7800DM-30, 7800DM-32, 7800DM-28, 7800DM-8, 7800DM-9, 7800DM-10, 7800DM-25, 7800DM-29

8155-1/2

111M-19, 111M-17, 111M-18, 111M-15, 111M-16, 111M-14, 111M-20

8154-11

8160-5, 8160-10

8166

FF1A5036 - 6 piezas



FF1A5036

	€		
38 x 445 x 543 mm	260,79	1	FF1A5036

BE258

BE250

BE256P3

BE254A

FF1A5037 - 12 piezas



FF1A5037

	€		
75 x 445 x 543 mm	1.524,93	1	FF1A5037

BPC813

BP814A

BP824

BP110

BP118

FF1A5038 - 50 piezas



FF1A5038

	€		
45 x 445 x 543 mm	243,07	1	FF1A5038

BBR300P50

FF1A51 - 23 piezas



FF1A51

	€		
40 x 445 x 543 mm	313,73	1	FF1A51

1-100-08-1-2	
1-210-08-1-2	
1-230-08-1-2	
4-144-08-2-2	
1-170-08-1-2	
3735-4-120	
3733-4, 3733-2, 3733-6	
3734-2, 3734-3, 3734-4, 3734-5, 3734-6, 3734-8	
2800-180, 2800-150	
2890-140, 2890-180	
2900-150, 2900-180	
2990-140, 2990-180	

FF1A53 - 36piezas



FF1A53

	€		
45 x 445 x 543 mm	201,57	1	FF1A53

BE-8800, BE-8811, BE-8821	
BE-8830	
BE-8600, BE-8611, BE-8621	
BE-8630	
BE-8910, BE-8915, BE-8920, BE-8925	
BE-9770	
BE-9780	
3625S-44	
2800-225	
2890-210	

FF1A54 - 75 piezas



FF1A54

	€		
35 x 445 x 543 mm	268,99	1	FF1A54

S1612L	
S0810L	
S330L	

FF1A55 - 75 piezas



FF1A55

	€		
40 x 445 x 543 mm	385,27	1	FF1A55

A6700DZ-1/2, A6700DZ-1/4, A6700DZ-11/32, A6700DZ-3/16, A6700DZ-3/8, A6700DZ-5/16, A6700DZ-7/16, A6700DZ-7/32, A6700DZ-9/16, A6700DZ-9/32	
--	--

BE-9775	
SBS61	
SBS63-2, SBS63-6, SBS63-4	
SBS65	
SBS67	
SBS81	
6956	
6972H	
7800DZ-1, 7800DZ-1/2, 7800DZ-11/16, 7800DZ-13/16, 7800DZ-15/16, 7800DZ-19/32, 7800DZ-3/4, 7800DZ-3/8, 7800DZ-5/8, 7800DZ-7/8, 7800DZ-9/16, 7800DZ-7/16	
808050	
6954	
8160-10, 8160-5	
8166	
8154-11	

FF1A56 - 28 piezas



FF1A56

	€		
63 x 445 x 543 mm	349,69	1	FF1A56

111Z-1, 111Z-1/2, 111Z-1/4, 111Z-11/16, 111Z-13/16, 111Z-15/16, 111Z-3/4, 111Z-3/8, 111Z-5/16, 111Z-5/8, 111Z-7/16, 111Z-7/8, 111Z-9/16	
1320RZ-1/2-9/16, 1320RZ-1/4-5/16, 1320RZ-3/8-7/16, 1320RZ-5/16-11/32	
6Z-1.1/16-1.1/4, 6Z-1-1.1/8, 6Z-1/2-9/16, 6Z-1/4-5/16, 6Z-15/16-1, 6Z-19/32-11/16, 6Z-25/32-13/16, 6Z-5/16-11/32, 6Z-5/8-3/4, 6Z-7/8-15/16	
9031	



FF1A65 - 28 piezas



FF1A65

	€		
50 x 445 x 543 mm	441,57	1	FF1A65

111M-19, 111M-17, 111M-18, 111M-24, 111M-21, 111M-22, 111M-7, 111M-8, 111M-6, 111M-11, 111M-12, 111M-9, 111M-10, 111M-15, 111M-16, 111M-13, 111M-14, 111M-20	
1RM-8, 1RM-9, 1RM-12, 1RM-13, 1RM-10, 1RM-11, 1RM-17, 1RM-14, 1RM-19	
319	

FF1A66 - 51 piezas



FF1A66

	€		
50 x 445 x 543 mm	304,88	1	FF1A66

038.055.100, 038.065.125, 038.080.150	
039.001.100, 039.002.125	
1178-SCRIBE	
426TOR9	
6972H	
9045-B-250	
BE-8010S, BE-8230S	
BE-8040	
BE-8150, BE-8155	
BE-8800, BE-8811, BE-8821	
BE-8830	
MTB-5-25	
SQZ150003	
59S/31-1	

FF1A67 - 28 piezas



FF1A67

	€		
39 x 445 x 543 mm	377,86	1	FF1A67

9031	
2101G-160IP	
21HDG-180IP	
2427 G-160 IP	
2430 G-160 IP	
8224 IP	
BE-8600, BE-8611, BE-8621	
BE-8630	
BE-8910, BE-8915, BE-8920, BE-8925	
7865	

FF1A68 - 30 piezas



FF1A68

	€		
37 x 445 x 543 mm	266,72	1	FF1A68

1-100-08-1-2	
1-170-08-1-2	
1-210-08-1-2	
1-230-08-1-2	
2800-180	
2890-180	
2900-180	
2990-180	
3733-4, 3733-2, 3733-6	
3734-8, 3734-5, 3734-6, 3734-3, 3734-4, 3734-2	

3735-4-120

4-144-08-2-2

481-400

BE-9770



FF1A70 - 105 piezas



FF1A70

	€		
42 x 445 x 543 mm	317,46	1	FF1A70

BE5049	
S560	

FF1A71 - 46 piezas



FF1A71

	€		
41 x 445 x 543 mm	195,60	1	FF1A71

901T-010-100, 901T-015-150, 901T-020-150, 901T-027-150, 901T-030-200, 901T-040-200, 901T-025-150, 901T-045-200, 901T-050-200	
B190.055.125	
B191.030.075, B191.040.100	
B192.001.100, B192.002.125	
B705.1/4.125	
59/S31B	

FF1A72 - 18 piezas



FF1A72

	€		
38 x 445 x 543 mm	347,03	1	FF1A72

2101GC-160IP	
2430 GC-200 IP	
2630GC-180IP	
2800-180	
2890-180	
2900-180	
2953-200	
2990-180	
3640-200-C	
3734N-10-150, 3734N-2-150, 3734N-3-150, 3734N-4-150, 3734N-5-150, 3734N-6-150, 3734N-8-150	
479-16	
3625W-35	

FF1A82- 25 piezas



FF1A82

	€		
43 x 445 x 543 mm	194,78	1	FF1A82

3734S/6	
479-16	
3625W-35	
MTG-3-16	
KB18-01	
KSBG18-10DISPEN	
2101G-180IP	
2678 G-180	
2470 G-200	
720031	
8224 IP	

FF1F1001-8 piezas



FF1F1001

	€		
40 x 362 x 445 mm	112,60	1	FF1F1001

BE-8210, BE-8030, BE-8040, BE-8240, BE-8242, BE-8252, BE-8250L	
BE-8255, BE-8257	

FF1F1002-11 piezas



FF1F1002

	€		
40 x 362 x 445 mm	153,96	1	FF1F1002

BE-8020, BE-8040, BE-8242, BE-8252	
BE-8330	
BE-8256, BE-8258	
BE-8610, BE-8620, BE-8623	
BE-8602	

FF1F1003-11 piezas



FF1F1003

	€		
38 x 362 x 445 mm	188,48	1	FF1F1003

BE-8030, BE-8242, BE-8252	
BE-8155	
BE-8870	
BE-8600, BE-8610, BE-8620, BE-8623, BE-8624	
808050S	

FF1F1004-10 piezas



FF1F1004

	€		
38 x 362 x 445 mm	139,87	1	FF1F1004

BE-8904, BE-8907, BE-8908	
BE-7910, BE-7915, BE-7920, BE-7925, BE-7927, BE-7930, BE-7940	

FF1F1005-42 piezas



FF1F1005

	€		
43 x 362 x 445 mm	220,49	1	FF1F1005

BE-8908, BE-8909, BE-8910, BE-8915, BE-8920, BE-8925, BE-8927, BE-8930	
--	--

K6650-1/4-1P	
808050S	
808050	
59S/31-3	



FF1F1006-8 piezas



ergo



FF1F1006

	€		
40 x 362 x 445 mm	129,22	1	FF1F1006

BE-8230S, BE-8040S, BE-8050S, BE-8255S	
BE-8810S, BE-8820S	
BE-8610S, BE-8620S	

FF1F1007-7 piezas



FF1F1007

	€		
35 x 362 x 445 mm	97,20	1	FF1F1007

901T-010-100, 901T-015-150, 901T-020-150, 901T-025-150, 901T-027-150, 901T-030-200, 901T-040-200	
--	--

FF1F1008-49 piezas



FF1F1008

	€		
38 x 362 x 445 mm	130,40	1	FF1F1008

B219.026	
B705.1/4.125	
B146.006.100	

B145.006.100	
BE-9770	
59S/31-1	

FF1F1009-14 piezas



FF1F1009

	€		
38 x 362 x 445 mm	112,60	1	FF1F1009

B219.026	
B219.025	
B196.030.100	
B195.002.025	
B195.050.025	

FF1F2001-44 piezas



FF1F2001

	€		
37 x 362 x 445 mm	451,72	1	FF1F2001

A6800DM-4, A6800DM-5, A6800DM-5.5, A6800DM-6, A6800DM-7, A6800DM-8, A6800DM-9, A6800DM-10, A6800DM-11, A6800DM-12, A6800DM-13	
6700SM-5, 6700SM-5.5, 6700SM-6, 6700SM-7, 6700SM-8, 6700SM-9, 6700SM-10, 6700SM-11, 6700SM-12, 6700SM-13, 6700SM-14	
6709PH-1, 6709PH-2, 6709PH-3	
6709PZ-1, 6709PZ-2	
6709M-3, 6709M-4, 6709M-5, 6709M-6, 6709M-8	
6709F-4.5, 6709F-5.5, 6709F-8	
BE-9778	
6950SL	
7765	
6954	
6962	
6966	

6972H	
6956	
1998M-12	

FF1F2002-53 piezas



FF1F2002

	€		
45 x 362 x 445 mm	160,04	1	FF1F2002

SL25L	
2058/S26	
6956	
1419-MD	

FF1F2101-36 piezas



FF1F2101

	€		
37 x 362 x 445 mm	560,70	1	FF1F2101

7400SM-7, 7400SM-8, 7400SM-9, 7400SM-10, 7400SM-11, 7400SM-12, 7400SM-13, 7400SM-14, 7400SM-15, 7400SM-16, 7400SM-17, 7400SM-18, 7400SM-19, 7400SM-20, 7400SM-21, 7400SM-22	
7409M-4, 7409M-6, 7409M-8, 7409M-10	
A7402DM-10, A7402DM-11, A7402DM-12, A7402DM-13	
A7410DZ-5/16, A7410DZ-7/16, A7410DZ-9/16, A7410DZ-3/8, A7410DZ-5/8	
7750SL	
7762	
7754	
7766	
7764	
8164-1/2	
7756	

BAHCO

FF1F2102-34 piezas



FF1F2102

40 x 362 x 445 mm € 177,81 1 FF1F2102

S330L

FF1F2103-38 piezas

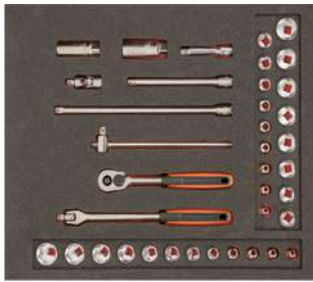

FF1F2103

35 x 362 x 445 mm € 137,49 1 FF1F2103

S380

FF1F2201-35 piezas



FF1F2201

50 x 362 x 445 mm € 413,71 1 FF1F2201

7800SM-10, 7800SM-12, 7800SM-13, 7800SM-17, 7800SM-18, 7800SM-19, 7800SM-20, 7800SM-21, 7800SM-22, 7800SM-24, 7800SM-27, 7800SM-30, 7800SM-32

7800DM-10, 7800DM-11, 7800DM-12, 7800DM-13, 7800DM-14, 7800DM-15, 7800DM-16, 7800DM-17, 7800DM-18, 7800DM-19

7809M-5, 7809M-6, 7809M-7, 7809M-8, 7809M-10, 7809M-12

8150SL

8160-5, 8160-10

8166

8154-11

8171

FF1F2202-24 piezas



FF1F2202

50 x 362 x 445 mm € 183,74 1 FF1F2202

S240

S81SL

FF1F5004-50 piezas



FF1F5004

35 x 362 x 445 mm € 171,89 1 FF1F5004

BE5049

1419-MD

FF1F5013-39 piezas



FF1F5013

35 x 362 x 445 mm € 213,11 1 FF1F5013

BS1000

FF1F2203-27 piezas



FF1F2203

50 x 362 x 445 mm € 367,47 1 FF1F2203

K7801M-10, K7801M-12, K7801M-13, K7801M-14, K7801M-15, K7801M-16, K7801M-17, K7801M-18, K7801M-19, K7801M-21, K7801M-22, K7801M-24

K7806M-10, K7806M-12, K7806M-13, K7806M-14, K7806M-15, K7806M-16, K7806M-17, K7806M-18, K7806M-19, K7806M-21, K7806M-22, K7806M-24, K7806M-27, K7806M-30, K7806M-32

FF1F3001-11 piezas



FF1F3001

40 x 362 x 445 mm € 113,62 1 FF1F3001

6M-6-7, 6M-8-9, 6M-10-11, 6M-12-13, 6M-14-15, 6M-16-18, 6M-17-19, 6M-20-22, 6M-21-23, 6M-24-27, 6M-30-32



FF1F3002-18 piezas



FF1F3002

	€		
41 x 362 x 445 mm	198,29	1	FF1F3002

- 111M-6, 111M-7, 111M-8, 111M-9, 111M-10, 111M-11, 111M-12, 111M-13, 111M-14, 111M-15, 111M-16, 111M-17, 111M-18, 111M-19, 111M-21, 111M-22, 111M-24, 111M-27

FF1F3003-30 piezas



FF1F3003

	€		
40 x 362 x 445 mm	264,61	1	FF1F3003

- 111M-6, 111M-7, 111M-8, 111M-9, 111M-10, 111M-11, 111M-12, 111M-13, 111M-14, 111M-15, 111M-16, 111M-17, 111M-18, 111M-19, 111M-20, 111M-21, 111M-22

1320SRM-14-19

1RMA-19-1/4-SQ

1RMA-19-1/2-SQ2

1RMA-13-10-BIT

BE-9778

FF1F3004-13 piezas



FF1F3004

	€		
42 x 362 x 445 mm	160,04	1	FF1F3004

- 111Z-3/8, 111Z-11/16, 111Z-1, 111Z-1/2, 111Z-13/16, 111Z-5/16, 111Z-5/8, 111Z-15/16, 111Z-7/16, 111Z-3/4, 111Z-1/4, 111Z-9/16, 111Z-7/8

FF1F3005-15 piezas



FF1F3005

	€		
39 x 362 x 445 mm	416,08	1	FF1F3005

- 1RM-8, 1RM-10, 1RM-12, 1RM-13, 1RM-14, 1RM-15, 1RM-16, 1RM-17, 1RM-18, 1RM-19, 1RM-21, 1RM-22

1RMA-13-10-BIT

1RMA-19-1/2-SQ2

FF1F3006-7 piezas



FF1F3006

	€		
35 x 362 x 445 mm	272,64	1	FF1F3006

- 1RM-19, 1RM-21, 1RM-22, 1RM-24, 1RM-27, 1RM-30

FF1F3007-10 piezas



FF1F3007

	€		
47 x 362 x 445 mm	178,93	1	FF1F3007

- 2M-6-7, 2M-8-9, 2M-10-11, 2M-12-13, 2M-14-15, 2M-16-18, 2M-17-19, 2M-21-23, 2M-24-27, 2M-30-32

FF1F3008-9 piezas



FF1F3008

	€		
38 x 362 x 445 mm	412,53	1	FF1F3008

- 4040M-6-7, 4040M-8-9, 4040M-10-11, 4040M-12-13, 4040M-14-15, 4040M-16-17, 4040M-18-19, 4040M-20-22, 4040M-21-23

FF1F3009-8 piezas



FF1F3009

	€		
35 x 362 x 445 mm	272,64	1	FF1F3009

1949M-8-9, 1949M-10-11, 1949M-12-13, 1949M-14-15, 1949M-17-19, 1949M-19-22, 1949M-24-27, 1949M-30-32



FF1F3010-17 piezas



FF1F3010

35 x 362 x 445 mm € 195,60 1 FF1F3010

1RM/S5

111M/SH12



FF1F3011-13 piezas



FF1F3011

35 x 362 x 445 mm € 201,53 1 FF1F3011

S4RM/3T

111M/SH12



FF1F4001-8 piezas



FF1F4001

35 x 362 x 445 mm € 289,24 1 FF1F4001

2430 G-160 IP

2421 G-180 IP

2101G-160IP

2628 G-200

8224 IP

9029

2951-140, 2951-300



FF1F4002-8 piezas



FF1F4002

35 x 362 x 445 mm € 269,09 1 FF1F4002

2928-160

2951-250

SC127

2101G-160IP

2430 G-160 IP

2339 DIP

2628 G-180IP

8224 IP



FF1F4003-4 piezas



FF1F4003

35 x 362 x 445 mm € 155,03 1 FF1F4003

2101G-160IP

8224 IP

2951-180

2430 G-200 IP



FF1F4004-8 piezas



FF1F4004

35 x 362 x 445 mm € 193,05 1 FF1F4004

2800-140, 2800-180

2890-140, 2890-180

2900-140, 2900-180

2990-140, 2990-180

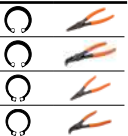

FF1F4005-5 piezas



FF1F4005

38 x 362 x 445 mm € 218,23 1 FF1F4005

2101S-160

2430 S-200

2427 S-200

8224 IP

2628 S-180



FF1F5001-10 piezas



FF1F5001



	€		
40 x 362 x 445 mm	215,25	1	FF1F5001

1-100-08-1-2	
1-160-08-1-2	
1-170-08-1-2	
1-210-08-1-2	
1-230-08-1-2	
2430 G-200 IP	
2628G-200IP	
7224	
2101G-160IP	
MTB-3-16	

FF1F5002-5 piezas



FF1F5002



	€		
38 x 362 x 445 mm	130,40	1	FF1F5002

2681	
MA401	
MA411	
1178-SCRIBE	
MTG-5-19	

FF1F5003-5 piezas



FF1F5003



	€		
35 x 362 x 445 mm	189,67	1	FF1F5003

8224	
2101G-160	
2430 G-160	
8071	
2951-250	

FF1F5005-8 piezas



FF1F5005



	€		
40 x 362 x 445 mm	88,90	1	FF1F5005

317	
3906-300-24-5P	
268	
2446	

FF1F5006-4 piezas



FF1F5006



	€		
50 x 362 x 445 mm	325,98	1	FF1F5006

CR W 01	
CR B 05	
3418 A	
BMMTRMS1	

FF1F5007-5 piezas



FF1F5007



	€		
45 x 362 x 445 mm	201,53	1	FF1F5007

4543-1, 4543-2, 4543-3	
4545-2	
4541-A	

FF1F5008-11 piezas



FF1F5008



	€		
37 x 362 x 445 mm	106,68	1	FF1F5008

2633/S4, 2633L/S4	
2489	
2485	
KE18-01	

FF1F5009-5 piezas



FF1F5009

	€		
60 x 362 x 445 mm	243,02	1	FF1F5009

BS618, BS623	
4545-2	
4545-N11	
4532-0	

FF1F5010-9 piezas



FF1F5010

	€		
45 x 362 x 445 mm	207,45	1	FF1F5010

BBR6135	
BBR6131	
BBR110	
1949M-8-9, 1949M-10-11	
7809M-6, 7809M-8, 7809M-10	
783	

FF1F5011-7 piezas



FF1F5011

	€		
100 x 362 x 445 mm	910,89	1	FF1F5011

BP815	
BP821	
BP822	
BP823	

FF1F5012-9 piezas



FF1F5012

	€		
55 x 362 x 445 mm	426,76	1	FF1F5012

BWSS12P317, BWSS12P319, BWSS12P321	
BPC814	
BWTB12P120	
GL008-10	
783	
8157-15	

FF1E1001-7 piezas



FF1E1001

	€		
38 x 181 x 445 mm	93,65	1	FF1E1001

BE-8030, BE-8040, BE-8242, BE-8252	
BE-8610, BE-8620, BE-8623	

FF1E1002-7 piezas



FF1E1002

	€		
39 x 181 x 445 mm	90,10	1	FF1E1002

BE-8242, BE-8040, BE-8030	
BE-8257, BE-8255	
BE-8611, BE-8621	

FF1E1003-6 piezas



FF1E1003

	€		
38 x 181 x 445 mm	85,35	1	FF1E1003

BE-8240	
BE-8150, BE-8255, BE-8256	
BE-8810, BE-8820	

FF1E1004-8 piezas



FF1E1004

	€		
40 x 181 x 445 mm	94,83	1	FF1E1004

BE-8340, BE-8350	
BE-8600, BE-8610	
BE-8811, BE-8800, BE-8820L, BE-8821	



FF1E1005-7 piezas



ergo



FF1E1005

	€			
40 x 181 x 445 mm	86,54	1	FF1E1005	

BE-8210, BE-8010		
BE-8811, BE-8821, BE-8800		
BE-8600		
BE-8830		

FF1E1006-6 piezas



ergo



FF1E1006

	€			
40 x 181 x 445 mm	88,90	1	FF1E1006	

BE-8210		
BE-8610, BE-8620		
BE-8630		
BE-8811, BE-8820		

FF1E1007-6 piezas



ergo



FF1E1007

	€			
40 x 181 x 445 mm	77,05	1	FF1E1007	

BE-8910, BE-8915, BE-8920, BE-8925, BE-8930, BE-8940		
--	--	--

FF1E1008-6 piezas



ergo



FF1E1008

	€			
38 x 181 x 445 mm	91,28	1	FF1E1008	

BE-7910, BE-7930, BE-7925, BE-7920, BE-7915, BE-7940		
--	--	--

FF1E1009-6 piezas



ergo



FF1E1009

	€			
38 x 181 x 445 mm	71,13	1	FF1E1009	

BE-8908, BE-8910, BE-8915, BE-8920, BE-8925, BE-8930		
--	--	--

FF1E1010-6 piezas



ergo



FF1E1010

	€			
39 x 181 x 445 mm	86,54	1	FF1E1010	

BE-8010S, BE-8230S, BE-8050S, BE-8255S		
--	--	--

BE-8610S, BE-8620S		
--------------------	--	--

FF1E1011-6 piezas



ergo



FF1E1011

	€			
45 x 181 x 445 mm	101,95	1	FF1E1011	

BE-8040S, BE-8050S, BE-8255S, BE-8065S		
--	--	--

BE-8610S, BE-8620S		
--------------------	--	--

FF1E2001-37 piezas



FF1E2001

	€			
38 x 181 x 445 mm	316,89	1	FF1E2001	

6700SM-4, 6700SM-5, 6700SM-5.5, 6700SM-6, 6700SM-7, 6700SM-8, 6700SM-9, 6700SM-10, 6700SM-11, 6700SM-12, 6700SM-13, 6700SM-14		
---	--	--

6700TORX-E4, 6700TORX-E5, 6700TORX-E6, 6700TORX-E7, 6700TORX-E8, 6700TORX-E10		
---	--	--

6709M-3, 6709M-4, 6709M-5, 6709M-6, 6709M-8		
---	--	--

6709TORX-T8, 6709TORX-T9, 6709TORX-T10, 6709TORX-T15, 6709TORX-T20, 6709TORX-T25, 6709TORX-T30, 6709TORX-T27, 6709TORX-T40		
--	--	--

6950SL		
--------	--	--

6954		
------	--	--

6956		
------	--	--

6960		
------	--	--

6966		
------	--	--

FF1E2002-45 piezas



FF1E2002

	€		
38 x 181 x 445 mm	334,28	1	FF1E2002

6700SM-4, 6700SM-4.5, 6700SM-5, 6700SM-5.5, 6700SM-6, 6700SM-7, 6700SM-8, 6700SM-9, 6700SM-10, 6700SM-11, 6700SM-12, 6700SM-13, 6700SM-14		
6709PZ-1, 6709PZ-3, 6709PZ-2		
6709PH-1, 6709PH-2, 6709PH-3		
6709TORX-T10, 6709TORX-T15, 6709TORX-T20, 6709TORX-T25, 6709TORX-T30, 6709TORX-T40		
6709F-4.5, 6709F-5.5, 6709F-8		
6709M-3, 6709M-4, 6709M-5, 6709M-6, 6709M-8		
1998M-3, 1998M-2.5, 1998M-2, 1998M-1.5		
6950SL		
6962-W		
6966		
6956		
6960, 6961		
7765		
6954		

FF1E2003-27 piezas



FF1E2003

	€		
38 x 181 x 445 mm	199,15	1	FF1E2003

6700SM-5, 6700SM-5.5, 6700SM-6, 6700SM-7, 6700SM-8, 6700SM-9, 6700SM-10, 6700SM-11, 6700SM-12, 6700SM-13, 6700SM-14		
BE-9778		
6950SL		
6956		
6962		

6966	
7765	
6954	
1998M-12	

FF1E2004-48 piezas



FF1E2004

	€		
44 x 181 x 445 mm	210,24	1	FF1E2004

A6700DM-8, A6700DM-9, A6700DM-10, A6700DM-11, A6700DM-12, A6700DM-13, A6700DM-14, A6700DM-5, A6700DM-5.5, A6700DM-6, A6700DM-7		
808050S		
6950SL		
6966		
6972H		
6962		
7765		
59S/31-1		

FF1E2005-17 piezas



FF1E2005

	€		
35 x 181 x 445 mm	177,41	1	FF1E2005

6700SM-5.5, 6700SM-6, 6700SM-7, 6700SM-8, 6700SM-9, 6700SM-10, 6700SM-11, 6700SM-12, 6700SM-13, 6700SM-14		
6950RN		
6962, 6960		
6966		
6954		
6956		
6972H		

FF1E2006-35 piezas



FF1E2006

	€		
39 x 181 x 445 mm	323,54	1	FF1E2006

6700SZ-5/16, 6700SZ-5/32, 6700SZ-11/32, 6700SZ-7/16, 6700SZ-9/32, 6700SZ-3/16, 6700SZ-3/8, 6700SZ-7/32, 6700SZ-1/4, 6700SZ-1/2, 6700SZ-9/16		
6709PZ-1, 6709PZ-2, 6709PZ-3		
6709PH-1, 6709PH-2, 6709PH-3		
6709TORX-T8, 6709TORX-T10, 6709TORX-T15, 6709TORX-T20, 6709TORX-T25, 6709TORX-T30		
6709F-4.5, 6709F-6.5, 6709F-8		
6950RN		
6954		
6972H		
6960, 6962		
6963		
6966		
6956		
7765		

FF1E2007-24 piezas



FF1E2007

	€		
35 x 181 x 445 mm	182,26	1	FF1E2007

6700SZ-9/32, 6700SZ-3/16, 6700SZ-3/8, 6700SZ-1/4, 6700SZ-7/16, 6700SZ-7/32, 6700SZ-1/2, 6700SZ-11/32		
1995Z-5/64, 1995Z-5/32, 1995Z-3/8, 1995Z-3/32, 1995Z-7/32, 1995Z-1/8, 1995Z-5/16, 1995Z-3/16, 1995Z-1/4		
6950RN		
6954		
6972H		
6960, 6962		
6956		
6966		



FF1E2008-26 piezas



FF1E2008

	€		
35 x 181 x 445 mm	189,82	1	FF1E2008

6700SM-5.5, 6700SM-6, 6700SM-7, 6700SM-8, 6700SM-9, 6700SM-10, 6700SM-11, 6700SM-12, 6700SM-13, 6700SM-14		
1995M-2, 1995M-3, 1995M-4, 1995M-5, 1995M-6, 1995M-7, 1995M-8, 1995M-9, 1995M-10		
6950RN		
6960, 6962		
6966		
6954		
6956		
6972H		

FF1E2101-24 piezas



FF1E2101

	€		
40 x 181 x 445 mm	276,19	1	FF1E2101

7400SM-6, 7400SM-7, 7400SM-8, 7400SM-9, 7400SM-10, 7400SM-11, 7400SM-12, 7400SM-13, 7400SM-14, 7400SM-15, 7400SM-16, 7400SM-17, 7400SM-18, 7400SM-19, 7400SM-20, 7400SM-22		
7750SL		
7760, 7761, 7762		
7764		
7766		
7754		
8164-1/2		

FF1E2102-25 piezas



FF1E2102

	€		
38 x 181 x 445 mm	292,79	1	FF1E2102

7400SM-6, 7400SM-7, 7400SM-8, 7400SM-9, 7400SM-10, 7400SM-11, 7400SM-12, 7400SM-13, 7400SM-14, 7400SM-15, 7400SM-16, 7400SM-17, 7400SM-18, 7400SM-19		
7409M-4, 7409M-5, 7409M-6, 7409M-8, 7409M-10		
7750SL		
7760, 7762		
7754		
7768		
8164-1/2		

FF1E2103-28 piezas



FF1E2103

	€		
38 x 181 x 445 mm	353,06	1	FF1E2103

7400SM-7, 7400SM-8, 7400SM-9, 7400SM-10, 7400SM-11, 7400SM-12, 7400SM-13, 7400SM-14, 7400SM-15, 7400SM-16, 7400SM-17, 7400SM-18, 7400SM-19, 7400SM-20, 7400SM-21, 7400SM-22		
7400TORX-E8, 7400TORX-E10, 7400TORX-E12, 7400TORX-E14, 7400TORX-E16, 7400TORX-E18		
7750SL		
7760, 7762		
7768		
7766		
SBS705		

FF1E2104-20 piezas



FF1E2104

	€		
38 x 181 x 445 mm	255,04	1	FF1E2104

7400SM-6, 7400SM-8, 7400SM-9, 7400SM-10, 7400SM-11, 7400SM-12, 7400SM-13, 7400SM-14, 7400SM-15, 7400SM-16, 7400SM-17, 7400SM-18, 7400SM-19, 7400SM-20, 7400SM-22		
7750RN		
7761, 7762		
7766		
7768		

FF1E2105-28 piezas



FF1E2105

	€		
35 x 181 x 445 mm	324,81	1	FF1E2105

7400TORX-E8, 7400TORX-E10, 7400TORX-E11, 7400TORX-E12, 7400TORX-E14, 7400TORX-E16, 7400TORX-E18		
7409TORX-T25, 7409TORX-T30, 7409TORX-T40, 7409TORX-T45, 7409TORX-T50		
7409TORX-T25-L, 7409TORX-T30-L, 7409TORX-T40-L, 7409TORX-T45-L, 7409TORX-T50-L		
7409M-4, 7409M-5, 7409M-6, 7409M-8, 7409M-10		
7409F-6.5, 7409F-8, 7409F-10		
7409PH-1, 7409PH-2, 7409PH-3		

FF1E2201-21 piezas



FF1E2201

44 x 181 x 445 mm € 264,07 1 FF1E2201

7800SM-10, 7800SM-11, 7800SM-12, 7800SM-13, 7800SM-14, 7800SM-15, 7800SM-17, 7800SM-18, 7800SM-19, 7800SM-20, 7800SM-21, 7800SM-22, 7800SM-24, 7800SM-27

7805SM-16, 7805SM-21

8150SL

8160-5, 8160-10

8166

8171

FF1E2203-22 piezas



FF1E2203

50 x 181 x 445 mm € 245,50 1 FF1E2203

7800SM-8, 7800SM-9, 7800SM-10, 7800SM-11, 7800SM-12, 7800SM-13, 7800SM-14, 7800SM-15, 7800SM-16, 7800SM-17, 7800SM-18, 7800SM-19, 7800SM-22, 7800SM-21, 7800SM-24, 7800SM-27, 7800SM-30, 7800SM-32

8150RN-1/2

8160-5, 8160-10

8166

FF1E2205-28 piezas



FF1E2205

50 x 181 x 445 mm € 272,64 1 FF1E2205

7800DM-10, 7800DM-11, 7800DM-12, 7800DM-13, 7800DM-14, 7800DM-15, 7800DM-16, 7800DM-17, 7800DM-18, 7800DM-19, 7800DM-20, 7800DM-21, 7800DM-22, 7800DM-23, 7800DM-24, 7800DM-25, 7800DM-26, 7800DM-27, 7800DM-28, 7800DM-30, 7800DM-32

7809M-6, 7809M-7, 7809M-8, 7809M-9, 7809M-10, 7809M-12, 7809M-14

FF1E2202-21 piezas



FF1E2202

45 x 181 x 445 mm € 233,29 1 FF1E2202

7800SM-8, 7800SM-9, 7800SM-10, 7800SM-11, 7800SM-12, 7800SM-13, 7800SM-14, 7800SM-15, 7800SM-16, 7800SM-17, 7800SM-18, 7800SM-19, 7800SM-20, 7800SM-21, 7800SM-23, 7800SM-24, 7800SM-27

8150-1/2

8160-5, 8160-10

8166

FF1E2204-15 piezas



FF1E2204

45 x 181 x 445 mm € 193,32 1 FF1E2204

7800DZ-1/2, 7800DZ-3/4, 7800DZ-19/32, 7800DZ-7/8, 7800DZ-7/16, 7800DZ-11/16, 7800DZ-9/16, 7800DZ-13/16, 7800DZ-3/8, 7800DZ-5/8, 7800DZ-15/16

8150RN-1/2

8160-5, 8160-10

8166

FF1E2206-27 piezas



FF1E2206

50 x 181 x 445 mm € 267,90 1 FF1E2206

7800SM-10, 7800SM-11, 7800SM-12, 7800SM-13, 7800SM-14, 7800SM-15, 7800SM-16, 7800SM-17, 7800SM-18, 7800SM-19, 7800SM-20, 7800SM-21, 7800SM-22, 7800SM-23, 7800SM-24, 7800SM-25, 7800SM-26, 7800SM-27, 7800SM-28, 7800SM-30, 7800SM-32

7809XZN-8, 7809XZN-10

7809PZ-2, 7809PZ-3

7809F-8, 7809F-10



FF1E2207-25 piezas



FF1E2207



40 x 181 x 445 mm € 282,14 1 FF1E2207

7809TORX-T20, 7809TORX-T25, 7809TORX-T27, 7809TORX-T30, 7809TORX-T40, 7809TORX-T55, 7809TORX-T45, 7809TORX-T50, 7809TORX-T60



7800TORX-E8, 7800TORX-E10, 7800TORX-E12, 7800TORX-E14, 7800TORX-E16, 7800TORX-E18, 7800TORX-E20, 7800TORX-E24



BE-9675



FF1E2208-12 piezas



FF1E2208



35 x 181 x 445 mm € 163,85 1 FF1E2208

7809M-6, 7809M-7, 7809M-8, 7809M-9, 7809M-10, 7809M-12, 7809M-14, 7809M-17



7809M-5-180, 7809M-6-140, 7809M-8-120, 7809M-10-140



FF1E2209-20 piezas



FF1E2209



35 x 181 x 445 mm € 286,87 1 FF1E2209

7809M-5, 7809M-6, 7809M-7, 7809M-8, 7809M-10, 7809M-12, 7809M-14, 7809M-17



7809TORX-T25, 7809TORX-T27, 7809TORX-T30, 7809TORX-T40, 7809TORX-T45, 7809TORX-T50, 7809TORX-T55, 7809TORX-T60



7809XZN-6, 7809XZN-8, 7809XZN-10, 7809XZN-12



FF1E2210-14 piezas



FF1E2210



38 x 181 x 445 mm € 225,23 1 FF1E2210

7809M-5, 7809M-6, 7809M-7, 7809M-8, 7809M-10, 7809M-12, 7809M-14, 7809M-17, 7809M-19



BE-7606, BE-7607



BWSS12P317, BWSS12P319, BWSS12P321



FF1E2211-21 piezas



FF1E2211



50 x 181 x 445 mm € 314,13 1 FF1E2211

7993S0050, 7993S0060, 7993S0080, 7993S0100, 7993S0120, 7993S0140, 7993S0170, 7993S0190



7994S0300, 7994S0400, 7994S0450, 7994S0500, 7994S0550, 7994S0600



K7801TORX-E10, K7801TORX-E12, K7801TORX-E14, K7801TORX-E16, K7801TORX-E18, K7801TORX-E20, K7801TORX-E24



FF1E2212-12 piezas



FF1E2212



40 x 181 x 445 mm € 124,48 1 FF1E2212

K7801M-10, K7801M-12, K7801M-13, K7801M-14, K7801M-15, K7801M-16, K7801M-17, K7801M-18, K7801M-19, K7801M-21, K7801M-22, K7801M-24



FF1E2213-15 piezas



FF1E2213

	€		
45 x 181 x 445 mm	248,94	1	FF1E2213

K7806M-10, K7806M-12, K7806M-13, K7806M-14, K7806M-15, K7806M-16, K7806M-17, K7806M-18, K7806M-19, K7806M-21, K7806M-22, K7806M-24, K7806M-27, K7806M-30, K7806M-32

FF1E2501-13 piezas



FF1E2501

	€		
35 x 181 x 445 mm	220,29	1	FF1E2501

A7402DM-10, A7402DM-11, A7402DM-12, A7402DM-13, A7402DM-14

7805SM-12, 7805SM-13, 7805SM-14, 7805SM-15, 7805SM-16, 7805SM-17, 7805SM-18, 7805SM-19

FF1E2502-7 piezas



FF1E2502

	€		
45 x 181 x 445 mm	94,83	1	FF1E2502

K560F-4, K560F-5

K8167S

K8160D-1, K8160D-2

K7764D

K8964D

FF1E5005-35 piezas



FF1E5005

	€		
36 x 181 x 445 mm	160,04	1	FF1E5005

BWTSP16

1418S

FF1E5006-6 piezas



FF1E5006

	€		
42 x 181 x 445 mm	118,54	1	FF1E5006

D/S14

BWSS12P3

BWTB12P120, BWTB12P110

FF1E5009-17 piezas



FF1E5009

	€		
36 x 181 x 445 mm	82,98	1	FF1E5009

BE6217

FF1E3001-9 piezas



FF1E3001

	€		
47 x 181 x 445 mm	111,86	1	FF1E3001

6M-6-7, 6M-8-9, 6M-10-11, 6M-12-13, 6M-14-15, 6M-16-17, 6M-18-19, 6M-21-23, 6M-22-24

FF1E3002-3 piezas



FF1E3002

	€		
35 x 181 x 445 mm	87,27	1	FF1E3002

6M-25-28, 6M-27-29, 6M-30-32



FF1E3003-9 piezas



FF1E3003

	€		
41 x 181 x 445 mm	119,06	1	FF1E3003

- 6Z-1/2-9/16, 6Z-15/16-1, 6Z-5/16-11/32, 6Z-5/8-3/4, 6Z-3/8-7/16, 6Z-25/32-13/16, 6Z-19/32-11/16, 6Z-1/4-5/16, 6Z-3/4-7/8

FF1E3004-10 piezas



FF1E3004

	€		
39 x 181 x 445 mm	277,38	1	FF1E3004

- 1RM-10, 1RM-9, 1RM-8, 1RM-14, 1RM-13, 1RM-12, 1RM-11, 1RM-17, 1RM-16, 1RM-15

FF1E3005-40 piezas



FF1E3005

	€		
42 x 181 x 445 mm	245,38	1	FF1E3005

- 59S/31-1
- 6966
- 41RM-8, 41RM-10, 41RM-12, 41RM-13, 41RM-14, 41RM-17, 41RM-19
- 8166

FF1E3006-8 piezas



FF1E3006

	€		
35 x 181 x 445 mm	296,35	1	FF1E3006

- 1320RM-6-7, 1320RM-8-9, 1320RM-10-11, 1320RM-12-13, 1320RM-14-15, 1320RM-16-17, 1320RM-18-19, 1320RM-22-24

FF1E3007-7 piezas



FF1E3007

	€		
35 x 181 x 445 mm	92,46	1	FF1E3007

- 2M-6-7, 2M-8-9, 2M-10-11, 2M-12-13, 2M-14-15, 2M-16-17, 2M-18-19

FF1E3008-9 piezas



FF1E3008

	€		
50 x 181 x 445 mm	194,41	1	FF1E3008

- 27M-8-9, 27M-10-11, 27M-12-13, 27M-14-15, 27M-16-17, 27M-18-19, 27M-20-22, 27M-21-23, 27M-24-27

FF1E4001-4 piezas



ergo



FF1E4001

	€		
35 x 181 x 445 mm	142,00	1	FF1E4001

- 2628 G-180IP
- 8231 IP
- 2430 G-200 IP
- 2101G-160IP

FF1E4002-4 piezas



FF1E4002

	€		
35 x 181 x 445 mm	101,71	1	FF1E4002

- 2900-180
- 2890-180
- 2990-180
- 2800-180

FF1E5007-3 piezas



ergo



FF1E5007

	€		
38 x 181 x 445 mm	171,89	1	FF1E5007

- 1410
- 9033
- 8225

FF1E5001-7 piezas



FF1E5001

45 x 181 x 445 mm € 201,34 1 FF1E5001

- MTB-5-25
- 8045LVDE
- WR2-MM
- 1544
- 1178-SCRIBE
- 5515T
- 1150D

FF1E5004-35 piezas



FF1E5004

36 x 181 x 445 mm € 100,75 1 FF1E5004

- 481-400
- 3734S/6
- 7865

FF1E5002-11 piezas



FF1E5002

35 x 181 x 445 mm € 112,60 1 FF1E5002

- 3740-150, 3740-175, 3740-200
- 3734-2, 3734-3, 3734-4, 3734-5, 3734-6, 3734-8
- 481-100
- 1157

FF1E5003-11 piezas



FF1E5003

35 x 181 x 445 mm € 106,68 1 FF1E5003

- 481-300
- 3735-5-120
- 3739-300
- 3740-100, 3740-125, 3740-150, 3740-200
- 3733-2, 3733-3, 3733-4, 3733-5

FF1E5008-4 piezas



FF1E5008

37 x 181 x 445 mm € 112,60 1 FF1E5008

- 7805ZZ-16, 7805ZZ-21
- BE1P
- BE61110

Incluye 6 piezas



ergo



FF1E1012EH

55 x 185 x 480 mm € 51,56 1 FF1E1012EH

- BE-8030
- BE-8150
- BE-8621, BE-8611
- BE-8811, BE-8821

Incluye 6 piezas



ergo



FF1E1009EH

55 x 185 x 480 mm € 51,56 1 FF1E1009EH

- BE-8908, BE-8910, BE-8915, BE-8920, BE-8925, BE-8930

Incluye 6 piezas



ergo



FF1E1013EH

55 x 185 x 480 mm € 91,66 1 FF1E1013EH

- BE-8135TB, BE-8145TB, BE-8150TB, BE-8155TB
- BE-8810TB, BE-8820TB



Incluye 46 piezas



FF1E2009EH

55 x 185 x 480 mm € 108,85 1 FF1E2009EH

59/S31B-IP

6700SM-4, 6700SM-4.5, 6700SM-5, 6700SM-5.5, 6700SM-6, 6700SM-7, 6700SM-8, 6700SM-9, 6700SM-10, 6700SM-11, 6700SM-12, 6700SM-13

6962-W

6972H

6950SL

Incluye 11 piezas



FF1E2010EH

55 x 185 x 480 mm € 57,29 1 FF1E2010EH

S0810L

1419-MD

Incluye 18 piezas



FF1E2106EH

55 x 185 x 480 mm € 103,12 1 FF1E2106EH

7400SM-10, 7400SM-11, 7400SM-12, 7400SM-13, 7400SM-14, 7400SM-15, 7400SM-16, 7400SM-17, 7400SM-18, 7400SM-19, 7400SM-20, 7400SM-22

7760, 7761

7766

SBS750

7402GPR-16, 7402GPR-21

Incluye 21 piezas



FF1E2214EH

55 x 185 x 480 mm € 229,15 1 FF1E2214EH

7800SM-10, 7800SM-11, 7800SM-12, 7800SM-13, 7800SM-14, 7800SM-15, 7800SM-16, 7800SM-17, 7800SM-18, 7800SM-19, 7800SM-20, 7800SM-21, 7800SM-22, 7800SM-23, 7800SM-24, 7800SM-27, 7800SM-30, 7800SM-32

8150SL

8174A

8166

Incluye 14 piezas



FF1E2107EH

55 x 185 x 480 mm € 74,48 1 FF1E2107EH

S1214L

Incluye 12 piezas



FF1E2215EH

55 x 185 x 480 mm € 91,66 1 FF1E2215EH

S1612L

Incluye 49 piezas



FF1E2503EH

55 x 185 x 480 mm € 143,22 1 FF1E2503EH

BE5049

Incluye 11 piezas



FF1E3009EH

55 x 185 x 480 mm € 85,93 1 FF1E3009EH

111M-8, 111M-10, 111M-11, 111M-12, 111M-13, 111M-14, 111M-15, 111M-16, 111M-17, 111M-18, 111M-19

FF1E3010EH, 1/3, 5 piezas



FF1E3010EH

	€		
55 x 185 x 480 mm	91,66	1	FF1E3010EH

1RM-8, 1RM-10, 1RM-13, 1RM-17, 1RM-19	
---------------------------------------	--

Incluye 4 piezas



FF1E3011EH

	€		
55 x 185 x 480 mm	108,85	1	FF1E3011EH

8070 IP, 8071 IP, 8072 IP	
1419-MD	

Incluye 3 piezas



FF1E4003EH

	€		
55 x 185 x 480 mm	97,39	1	FF1E4003EH

8224 IP	
2101G-160IP	
2430 G-160 IP	

Incluye 4 piezas



FF1E4004EH

	€		
55 x 185 x 480 mm	108,85	1	FF1E4004EH

2681	
MA401	
MA411	
1178-SCRIBE	

Incluye 23 piezas



FF1E5010EH

	€		
55 x 185 x 480 mm	103,12	1	FF1E5010EH

481-400	
3734-2, 3734-3, 3734-4, 3734-5, 3734-6, 3734-8	
3735-5-120	
7865	

Incluye 4 piezas



FF1E4005EH

	€		
55 x 185 x 480 mm	120,31	1	FF1E4005EH

2800-150, 2800-180	
2900-150, 2900-180	

Incluye 11 piezas



FF1E5011EH

	€		
55 x 185 x 480 mm	97,39	1	FF1E5011EH

2633/S4, 2633L/S4	
2489	
2485	
KE18-01	

Incluye 36 piezas



FF1E5013EH

	€		
55 x 185 x 480 mm	91,66	1	FF1E5013EH

BE-9770	
2058/S26	
1419-MD	

Incluye 25 piezas



FF1E2011EH

	€		
55 x 185 x 480 mm	68,75	1	FF1E2011EH

SL25	
------	--



Incluye 24 piezas



FF1E2216EH

	€		
55 x 185 x 480 mm	143,22	1	FF1E2216EH

SBS81	
S240NB-NR	

Incluye 33 piezas



FF1E2504EH

	€		
55 x 185 x 480 mm	91,66	1	FF1E2504EH

S330	
------	--

Incluye 34 piezas



FF1E2505EH

	€		
55 x 185 x 480 mm	91,66	1	FF1E2505EH

S330AF	
--------	--

Incluye 8 piezas



FF1E5014EH

	€		
55 x 185 x 480 mm	103,12	1	FF1E5014EH

9031P	
8224	
208	
3906-300-24-5P	

Foam 1/3 vacio con colgador



FF1E5016EH

	€		
35 x 181 x 445 mm	28,64	1	FF1E5016EH

Incluye 4 piezas

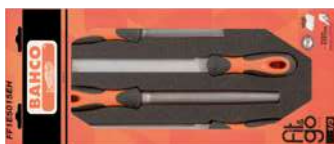

FF1E5015EH

	€		
55 x 185 x 480 mm	57,29	1	FF1E5015EH

1-100-08-2-2	
1-210-08-2-2	
4-138-08-1-2	
4-272-05-3-2	

MALETAS RÍGIDAS

Maleta rígida 4750RCWD4 con 162 herramientas



4750RCWD4FF1

	€		
453 x 340 x 575 mm	2.183,69	1	4750RCWD4FF1

4750RCWD4	
6700SM-10, 6700SM-9, 6700SM-12, 6700SM-11, 6700SM-6, 6700SM-8, 6700SM-7, 6700SM-13	
A6800DM-13, A6800DM-12, A6800DM-9, A6800DM-8, A6800DM-11, A6800DM-10, A6800DM-5.5, A6800DM-7, A6800DM-6	
6709M-3, 6709M-8, 6709M-6, 6709M-5, 6709M-4	
6709PH-1, 6709PH-3, 6709PH-2	
6709TORX-T30, 6709TORX-T27, 6709TORX-T40, 6709TORX-T15, 6709TORX-T10, 6709TORX-T25, 6709TORX-T20, 6709TORX-T9, 6709TORX-T8	
6950SL	
6954	
6956	
6958	
6960, 6962, 6962L	
6966	
6972H	
7764	
7800SM-25, 7800SM-24, 7800SM-27, 7800SM-26, 7800SM-21, 7800SM-23, 7800SM-22, 7800SM-17, 7800SM-16, 7800SM-19, 7800SM-18, 7800SM-13, 7800SM-12, 7800SM-15, 7800SM-14, 7800SM-9, 7800SM-8, 7800SM-11, 7800SM-10, 7800SM-28, 7800SM-32, 7800SM-30	
7809TORX-T45, 7809TORX-T25, 7809TORX-T50, 7809TORX-T30, 7809TORX-T27, 7809TORX-T40	
8150RN-1/2	
111M-30, 111M-32, 111M-27, 111M-29, 111M-24, 111M-19, 111M-18, 111M-21, 111M-15, 111M-14, 111M-17, 111M-16, 111M-11, 111M-10, 111M-13, 111M-12, 111M-7, 111M-6, 111M-9, 111M-8	
9070C	
BE-9770	

2058-BR	
1544	
MTB-3-16	
2101G-160IP	
2427 G-200 IP	
2430 G-200 IP	
2628 G-160IP	
8224 IP	
1150-1/2H/P	
5515T-52	
2820EF2	
481-300	
3625W-35	
3734-3, 3734-5, 3734-8	
3735-4-120	
1177-SCRIBE	
BFLA01	
8160-3, 8160-5, 8160-10	
8166	
8157-15	
8154-11	

BE-8910S, BE-8915S, BE-8920S, BE-8925S, BE-8930S	
SC127V	
1999MV-5, 1999MV-6, 1999MV-7, 1999MV-8, 1999MV-9, 1999MV-10, 1999MV-12	
2430V-160, 2430V-200	
2678V-180, 2678V-160, 2678V-200	
3416 A	
806-1-1	
BE-8600S, BE-8610S, BE-8620S, BE-8630S, BE-8640S	
527V-160	
2427V-200	
2MV-10, 2MV-11, 2MV-12, 2MV-13, 2MV-14, 2MV-15, 2MV-16, 2MV-17, 2MV-18, 2MV-19	
WR1-MM	
7800DMV-8, 7800DMV-10, 7800DMV-11, 7800DMV-12, 7800DMV-13, 7800DMV-14, 7800DMV-15, 7800DMV-16, 7800DMV-17, 7800DMV-18, 7800DMV-19, 7800DMV-20, 7800DMV-21, 7800DMV-22	
2820VPC	
8162-1/2V	
7224S	

6950SL	
6954	
6956	
6958	
6960, 6962, 6962L	
6966	
6972H	
7764	
7800SM-13, 7800SM-14, 7800SM-11, 7800SM-12, 7800SM-9, 7800SM-10, 7800SM-8, 7800SM-32, 7800SM-30, 7800SM-27, 7800SM-28, 7800SM-25, 7800SM-26, 7800SM-23, 7800SM-24, 7800SM-21, 7800SM-22, 7800SM-19, 7800SM-17, 7800SM-18, 7800SM-15, 7800SM-16	
7805SM-22, 7805SM-23, 7805SM-21, 7805SM-18, 7805SM-19, 7805SM-16, 7805SM-17, 7805SM-14, 7805SM-15, 7805SM-12, 7805SM-13, 7805SM-10, 7805SM-32, 7805SM-30, 7805SM-26, 7805SM-24, 7805SM-29, 7805SM-28, 7805SM-25, 7805SM-20	
7809TORX-T30, 7809TORX-T40, 7809TORX-T25, 7809TORX-T27, 7809TORX-T50, 7809TORX-T45	
8150RN-1/2	
111M-23, 111M-24, 111M-21, 111M-22, 111M-19, 111M-17, 111M-18, 111M-15, 111M-16, 111M-13, 111M-14, 111M-11, 111M-12, 111M-9, 111M-10, 111M-7, 111M-8, 111M-6, 111M-32, 111M-29, 111M-30, 111M-27, 111M-28, 111M-26, 111M-25	
1RM-18, 1RM-19, 1RM-16, 1RM-17, 1RM-14, 1RM-15, 1RM-12, 1RM-13, 1RM-10, 1RM-11, 1RM-8, 1RM-9, 1RM-6, 1RM-7	
9070C	
BE-9770	
BE-8571	
2058-BR	
2509	
1544	
2101G-160IP	
2427 G-200 IP	
2430 G-200 IP	
2628 G-160IP	
8224 IP	
1150-1/2H/P	
5515T-52	
2820EF2	
481-300	
3625W-35	
3734-3, 3734-5, 3734-8	
3735-4-120	
1177-SCRIBE	
2535F1	
BFLA01	
MTB-3-16	
8160-3, 8160-5, 8160-10	
8166	
8154-11	
8157-15	

Maleta rígida extra fuerte roja con 79 herramientas aisladas



4750RCHDW02RF1V

290 x 480 x 630 mm € 3.036,30 1 4750RCHDW02RF1V

Maleta rígida 4750RCHDW02 HD con ruedas y composición para MRO



4750RCHDW02FF1

275 x 460 x 600 mm € 2.492,05 1 4750RCHDW02FF1

4750RCHDW02RED	
8150-1/2V	
BMMTRMS1	
28MV-10, 28MV-15, 28MV-16, 28MV-21, 28MV-22, 28MV-12, 28MV-13	
2101S-160, 2101S-180	
2101S-200	
2223 S-150	
2820VDE	
BE-8040S, BE-8050S, BE-8010S, BE-8065S	
BE-8703S, BE-8704S, BE-8725S, BE-8705S, BE-8706S, BE-8708S	

4750RCHDW02	
6700SM-12, 6700SM-13, 6700SM-10, 6700SM-11, 6700SM-8, 6700SM-9, 6700SM-6, 6700SM-7, 6700SM-5.5	
A6800DM-13, A6800DM-11, A6800DM-12, A6800DM-9, A6800DM-10, A6800DM-7, A6800DM-8, A6800DM-5.5, A6800DM-6	
6709M-3, 6709M-4, 6709M-8, 6709M-5, 6709M-6	
6709PH-1, 6709PH-2, 6709PH-3	
6709TORX-T8, 6709TORX-T30, 6709TORX-T40, 6709TORX-T25, 6709TORX-T27, 6709TORX-T15, 6709TORX-T20, 6709TORX-T9, 6709TORX-T10	

1RM-18, 1RM-19, 1RM-16, 1RM-17, 1RM-14, 1RM-15, 1RM-12, 1RM-13, 1RM-10, 1RM-11, 1RM-8, 1RM-9, 1RM-6, 1RM-7	
9070C	
BE-9770	
BE-8571	
2058-BR	
2509	
1544	
2101G-160IP	
2427 G-200 IP	
2430 G-200 IP	
2628 G-160IP	
8224 IP	
1150-1/2H/P	
5515T-52	
2820EF2	
481-300	
3625W-35	
3734-3, 3734-5, 3734-8	
3735-4-120	
1177-SCRIBE	
2535F1	
BFLA01	
MTB-3-16	
8160-3, 8160-5, 8160-10	
8166	
8154-11	
8157-15	



Maleta rígida 4750RCHDW02 con 167 herramientas para industria eólica



4750RCHDW02FF2

	€		
480 x 290 x 630 mm	2.807,14	1	4750RCHDW02FF2

4750RCHDW02		
6700SM-12, 6700SM-13, 6700SM-10, 6700SM-11, 6700SM-8, 6700SM-9, 6700SM-6, 6700SM-7, 6700SM-5.5		
6954		
6956		
6958		
6960, 6961, 6962, 6962L		
6966		
6972H		
6950SL		
7800SM-13, 7800SM-14, 7800SM-11, 7800SM-12, 7800SM-10, 7800SM-32, 7800SM-30, 7800SM-27, 7800SM-24, 7800SM-21, 7800SM-19, 7800SM-17, 7800SM-18, 7800SM-15, 7800SM-16, 7800SM-22		
7809M-7, 7809M-6, 7809M-17, 7809M-19, 7809M-5, 7809M-14, 7809M-12, 7809M-10, 7809M-8		
7809TORX-T60, 7809TORX-T40, 7809TORX-T55, 7809TORX-T50, 7809TORX-T45		
59S/31-1		
8150SL		
111M-24, 111M-21, 111M-19, 111M-17, 111M-18, 111M-15, 111M-16, 111M-13, 111M-14, 111M-11, 111M-12, 111M-9, 111M-10, 111M-7, 111M-8, 111M-6, 111M-32, 111M-29, 111M-30, 111M-27		
BE-9770		
1177-SCRIBE		

6M-6-7, 6M-8-9, 6M-10-11, 6M-12-13, 6M-14-15, 6M-16-17, 6M-18-19, 6M-20-22, 6M-24-27, 6M-30-32	
MTB-3-16-E	
9070, 9072	
2535L	
BE-8020L, BE-8030	
BE-8155	
BE-8260	
BE-8610, BE-8620	
BE-8630	
BE-8810, BE-8820	
BE-8830	
1544	
2047-0.8-4	
TAH2047PR-1-2	
2058-BR	
2509	
808050P	
808050S	
BE-8220S, BE-8040S, BE-8050S	
BE-8610S, BE-8620S	
2535F2	
1150-1/2H/P	
2101G-160IP	
2427 G-200 IP	
2430 G-200 IP	
2628 G-160IP	
2820EF2	
5515T-52	
8224 IP	
BFLA01	
3625W-35	
3734-3, 3734-5, 3734-8	
3735-4-120	
481-300	
3680	
3875-RL1	
3875-WL1	
4750-3PB-2	
3750	
8157-15	
8154-11	
8160-5, 8160-10	
8171	
8166	

Maleta con set para mantenimiento de aerogeneradores



4750RCHDW02FF4

	€		
480 x 290 x 630 mm	3.959,33	1	4750RCHDW02FF4

TAH9070, TAH9072	
TAH3625W-35	
TAH481-300	
TAHBE-9777B	
TAH2820EF2	
TAH1150-1/2H/P	
TAH1177-SCRIBE	
TAH1544	
TAH2509	
TAH2535F2	
MTS-5-25	
TAHPINRELEASER	
TAH2427G-200	
TAH2430G-200	
TAH2628G-160	
TAH8224	
TAH2484-30	
TAH3734BM-3, TAH3734BM-8, TAH3734BM-5	
TAH3755BM-4	
TAHSCB140G	
TAHBE-8030, TAHBE-8020L	
TAHBE-8040S, TAHBE-8050S, TAHBE-8220S	
TAHBE-8155	
TAHBE-8260	
TAHBE-8620S, TAHBE-8610S	
TAHBE-8620, TAHBE-8610	
TAHBE-8630	
TAHBE-8810, TAHBE-8820	
TAHBE-8830	

TAH08-5.5, TAH08-9, TAH08-7, TAH08-8, TAH08-13, TAH08-6, TAH08-11, TAH08-10, TAH08-12		
TAH6961, TAH6962, TAH6960, TAH6962L		
TAH6956-1		
TAH6950		
TAH6966		
TAH6958B-1		
TAH16B-27, TAH16B-30, TAH16B-24, TAH16B-22, TAH16B-32, TAH16B-19, TAH16B-21, TAH16B-17, TAH16B-18, TAH16B-11, TAH16B-15, TAH16B-16, TAH16B-13, TAH16B-10, TAH16B-14, TAH16B-12		
TAH16-H8, TAH16-H6, TAH16-H7, TAH16-H5, TAH16-H17, TAH16-H19, TAH16-H12, TAH16-H14, TAH16-H10		
TAH16-T40, TAH16-T45, TAH16-T50, TAH16-T55, TAH16-T60		
TAH8166		
TAH8150-1/2		
TAH8160, TAH8162		
TAH8158B-1		
TAH111M-32, TAH111M-27, TAH111M-24, TAH111M-21, TAH111M-22, TAH111M-19, TAH111M-9, TAH111M-7, TAH111M-8, TAH111M-18, TAH111M-6, TAH111M-16, TAH111M-17, TAH111M-14, TAH111M-15, TAH111M-12, TAH111M-13, TAH111M-10, TAH111M-11, TAH111M-30		
TAH2101G-160		
TAH2047PR-1-2		
TAH2047-0.8-4		
4750RCHDW02		

Set para aerogeneradores heavy duty



4750RCHDW02FF15

	€		
480 x 290 x 630 mm	3.661,68	1	4750RCHDW02FF15

TAH1-100-06-2-4		
TAH1-210-06-2-2		
TAH1-230-06-2-2		

TAH3625PU-50		
TAH489-1100		
TAHBE64520		
TAHPINRELEASER		
TAHSCB140G		
TAH24B-50, TAH24B-46, TAH24B-41, TAH24B-38, TAH24B-36, TAH24B-32, TAH24B-30, TAH24B-27		
TAH8950N/A		
TAH8961		
TAH8953		
TAH7452-2		
TAH7435-100		
TAH111M-50, TAH111M-46, TAH111M-41, TAH111M-36, TAH111M-34		
TAH7444SG-M-46, TAH7444SG-M-41, TAH7444SG-M-36, TAH7444SG-M-55, TAH7444SG-M-50		
4750RCHDW02		
TAH73R-300		

Maleta rígida 4750RCHDW01 con 240 herramientas



4750RCHDW01FF1

	€		
250 x 345 x 545 mm	4.150,39	1	4750RCHDW01FF1

4750RCHDW01		
FF2B01		
FF2B02		
FF2B03		
FF2B04		
FF2B05		
FF2B06		

Maleta rígida 4750RCHDW01 con 159 herramientas



4750RCHDW01FF2

	€		
250 x 345 x 545 mm	2.999,37	1	4750RCHDW01FF2

4750RCHDW01		
FF2B07		
FF2B08		
FF2B09		
FF2B10		
FF2B11		

Maleta rígida 4750RCHDW01 con 194 herramientas



4750RCHDW01FF3

	€		
250 x 345 x 545 mm	2.671,03	1	4750RCHDW01FF3

4750RCHDW01		
FF2B12		
FF2B13		
FF2B14		
FF2B15		
FF2B16		



Set para mantenimiento de gruas de gas y petróleo en el agua



4750RCHDW01FF4



€



250 x 345 x 545 mm 1.876,90 1 4750RCHDW01FF4

TAH8075	
TAH479-32	
TAHBE-9777B	
TAHBE-9787	
TAH2820EF2	
TAHBFRL11	
TAH466-250	
TAHPINRELEASER	
TAH380-10	
TAH2101G-160	
TAH2628G-180	
TAH2855	
TAH8224	
TAHSCB140G	
TAHBE-8258	
TAHBE-8241, TAHBE-8252	
TAHBE-8620L, TAHBE-8620	
4750RCHDW01	
4750-HDLB-TAH	
3875-LY9	
3875-LY5	
3875-RL2	
3875-MHP4	
3875-MHP6	
3875-HB60	
3875-LY60	
3875-LY70	

Set para formación de gas y petróleo en el agua



4750RCHDW01FF9



€



250 x 345 x 545 mm 2.834,84 1 4750RCHDW01FF9

TAH8073	
TAH84-PODGER	
TAH3640-250-C	
TAH1-143-12-1-2	
TAH479-32	
TAH325	
TAHBE-9777B	
TAH2820EF2	
TAHBFRL11	
TAHPINRELEASER	
TAH380-14	
TAH2101G-140	
TAH2628G-180	
TAH2855	
TAH2958-250	
TAH2484-30	
TAH3734BM-8	
TAHSCB140G	
TAHBE-8257	
TAHBE-8602	
TAH16B-19	
TAH16B-11/16	
TAH16-H8	
TAH8150-1/2	
TAH8158B-1	
TAH1949M-14-17	
4750RCHDW01	
4750-HDLB-TAH	
3875-LY9	
3875-LY5	
3875-RL2	
3875-MHP4	
3875-MHP6	
3875-LY60	
3875-LY70	
MTS-5-25	

4750-MTHO-TAH	
3875-HB60	
TAH2487	
TAH466-250	
3875-LY60	
3875-LY70	
TAH73R-300	

Maleta rígida 4750RCHD01 + FF2A07 + FF2A08 + FF2A09 + FF2A10



4750RCHD01FF1



€



215 x 410 x 475 mm 2.749,85 1 4750RCHD01FF1

4750RCHD01	
FF2A07	
FF2A08	
FF2A10	
FF2A09	

Caja de herramientas Aluminio, 145 piezas



4750ALC01FF1



€



160 x 320 x 450 mm 808,55 1 4750ALC01FF1

111M-14, 111M-15, 111M-16, 111M-17, 111M-18, 111M-19, 111M-8, 111M-9, 111M-10, 111M-11, 111M-12, 111M-13	
--	--

BE-9678	
8072 C IP	
224 D	
2171G-160	
2339-220IP	
2678 G-180	
2470 G-160	
SCB140	
B191.030.075, B191.040.125	
B190.055.125, B190.065.150	
B192.001.100, B192.002.125	
806-1-1	
482F-30	
MTB-5-25	
208	
KB18-01	
808050TS	
59S/0.6-4.5-3P, 59S/1.0-5.5-3P, 59S/1.2-6.5-3P	
59S/PH1-3P, 59S/PH2-3P, 59S/PH3-3P, 59S/PH0-3P	
59S/PH2G-3P	
59S/PZ2-3P, 59S/PZ3-3P, 59S/PZ0-3P, 59S/PZ1-3P	
66IM/T20C-2P, 66IM/T15C-2P, 66IM/T10C-2P, 66IM/T40C-2P, 66IM/T30C-2P, 66IM/T27C-2P, 66IM/T25C-2P	
59S/H1.5-3P, 59S/H3-3P, 59S/H2.5-3P, 59S/H4-3P, 59S/H5-3P, 59S/H2-3P, 59S/H6-3P, 59S/H8-3P	
KM6750-11, KM6750-6, KM6750-7, KM6750-8	
KM6750-10, KM6750-13, K6650-1/4-1P	
KM653-1P	
KSBG18-10DISPEN	
700-1.5-50, 700-1.2-50, 700-1-50, 700-1.8-50	
701-00-50, 701-0-50	
3906-250-24-5P, 3906-250-32-5P	
3735N-4-120	
3734N-2-150, 3734N-4-150, 3734N-6-150	
SBS60-9, SBS60-10, SBS60-11, SBS60-12, SBS60-13, SBS60-4, SBS60-4.5, SBS60-5, SBS60-5.5, SBS60-6, SBS60-7, SBS60-8	
SBS61	
SB6963	
SBS64	
6960-3	
8160-10, 8160-5	
8158-10	
7800SM-20, 7800SM-21, 7800SM-22, 7800SM-23, 7800SM-24, 7800SM-27, 7800SM-12, 7800SM-13, 7800SM-14, 7800SM-15, 7800SM-16, 7800SM-17, 7800SM-18, 7800SM-19, 7800SM-10, 7800SM-11, 7800SM-30, 7800SM-32	
SBS81	
8166	
7772H	

Maleta rígida con ruedas con 32 herramientas



984010320

	€		
255 x 390 x 465 mm	814,01	1	984010320

Dotación: TS001

4750RCW01	
2101D-160IP	
224 D	
2630D-180	
2430 D-160 IP	
6M/8C	
8071 C IP	
483-20	
541D-180	
2951-180	
B191.030.075, B191.040.100	
B190.100.200, B190.065.150	
B192.001.100, B192.002.125	
SC127	
2820EF2	
BE-9777	
MTB-3-16	

Maleta rígida con dotación 32 herramientas



983100320

	€		
210 x 415 x 460 mm	562,20	1	983100320

4750RC02	
2101D-160IP	
224 D	
2430 D-160 IP	
8071 C IP	
483-20	
541D-180	
2951-180	
B191.030.075, B191.040.100	
B190.100.200, B190.065.150	
B192.001.100, B192.002.125	
SC127	
2820EF2	
BE-9777	
MTB-3-16	
2630DC-180IP	
6M/8C	

Maleta rígida con dotación de 32 herramientas



983000320

	€		
162 x 380 x 435 mm	525,98	1	983000320

Set 32 herramientas: TS001

4750RC01	
2101D-160IP	
224 D	
2630D-180	
2430 D-160 IP	
8071 C IP	
483-20	
541D-180	
2951-180	
6M/8C	
B191.030.075, B191.040.100	
B190.100.200, B190.065.125	
B192.001.100, B192.002.125	
SC127	
2820EF2	
BE-9777	
MTB-3-16	



Juego de herramientas para electrónica



1995LM-1.5, 1995LM-2, 1995LM-2.5, 1995LM-3, 1995LM-4	
1997M/10T	
2047-0.8-4, 2047-1-5.5	
2421 D-140IP	
2430 GC-200 IP	
2530-40	
2744	
4750RC021	
7372I-2.5-75	
8070 C	
2223 S-150	

2010

		€	
109	480 x 180 x 330 mm	3.208,08	1 2010

1952M-6, 1952M-7, 1952M-8, 1952M-9, 1952M-10, 1952M-11, 1952M-12, 1952M-13, 1952M-14	
4020L-M-3, 4020L-M-3.2, 4020L-M-3.5, 4020L-M-4, 4020L-M-4.5, 4020L-M-5.5	
BE-8340, BE-8350, BE-8355	
700-1.5-50, 700-1.2-50, 700-1-50, 700-1.8-50	
3659/8T	
5550-3.2, 5550-4.5	
BE-8220S, BE-8050S, BE-8255S	
5516 I	
5577-145	
5418	
2535L	
3524	
2648	
1150-1/2H/P	
1952Z-1/4, 1952Z-3/8, 1952Z-1/2	
BE-8620S	
BE-7845, BE-7806	
701-0-50, 701-00-50	
8045LVDE	
5574-145	
2-470-16-1-0x 6	
5515GV	
5423	
2665 B-160	
326000300	
328000000	
2656 R	
BE-3529	
BE-6400M-4, BE-6400M-5, BE-6400M-5.5, BE-6400M-7	
BE-8160	
BE-8600, BE-8610	

Maleta rígida extra fuerte con cuatro cajones



4750RCWD4

	€	
453 x 340 x 575 mm	777,48	1 4750RCWD4
453 x 340 x 575 mm	777,48	1 4750RCWD4-OR

Maleta rígida extra fuerte 153,9L



4750RCHDW10

	€	
460 x 560 x 860 mm	687,46	1 4750RCHDW10

Maleta con ruedas extra fuerte



4750RCHDW02

	€	
290 x 480 x 630 mm	510,75	1 4750RCHDW02
290 x 480 x 630 mm	510,75	1 4750RCHDW02RED

Copolimero inyectado en estructura de resina en polipropileno

Maleta rígida con ruedas Extra Fuerte



4750RCHDW01

	€	
240 x 350 x 545 mm	325,43	1 4750RCHDW01
240 x 350 x 545 mm	325,43	1 4750RCHDW01RED

estructura de resina en polipropileno

Maleta rígida copolimero extra fuerte



4750RCHD01

	€	
215 x 415 x 465 mm	281,55	1 4750RCHD01

Maleta rígida extra fuerte con separadores



4750RCHD011

	€		
215 x 415 x 465 mm	458,35	1	4750RCHD011

Maleta rígida



4750RC02

	€		
221 x 406 x 485 mm	257,53	1	4750RC02
221 x 406 x 485 mm	292,82	1	4750RC021

4750RC02: Bolsillos transparentes en el lateral 4750RC021: Gomas de sujeción en el lateral

Divisor pivotante para colocar bajo la tapa con huecos tipo bolsa



4750RCWD-AC2

	€		
30 x 277 x 507 mm	74,04	1	4750RCWD-AC2

Maleta rígida extra fuerte



4750RCHD00

	€		
205 x 345 x 400 mm	222,13	1	4750RCHD00

Maleta rígida



4750RC01

	€		
165 x 399 x 450 mm	216,87	1	4750RC01

Divisor pivotante para colocar bajo la tapa con tiras elásticas



4750RCWD-AC3

	€		
5 x 277 x 507 mm	74,04	1	4750RCWD-AC3

Maleta rígida con ruedas



4750RCW01

	€		
257 x 406 x 485 mm	515,07	1	4750RCW01
257 x 406 x 485 mm	554,61	1	4750RCW011

4750RCW01 con bolsillos transparentes 4750RCW011 con cintas goma de sujeción en tapa y parte baja

Juego de ruedas giratorias (x4) 50x18mm



4750RCWD-AC1

	€		
100 x 50 x 200 mm	80,21	1	4750RCWD-AC1

Para 4750RCWD4

Panel fijo para colocar bajo la tapa con tiras elásticas



4750RCWD-AC4

	€		
4 x 286 x 490 mm	55,54	1	4750RCWD-AC4



Panel desmontable tapa acolchada



4750RCHD01AC1

	€		
35 x 305 x 425 mm	52,38	1	4750RCHD01AC1

Bolsa acolchada extraíble para maleta 4750RCHD01



4750RCHD01AC2

	€		
135 x 360 x 450 mm	124,42	1	4750RCHD01AC2

Panel desmontable tapa acolchada



4750RCHD01AC1

	€		
50 x 204 x 500 mm	52,38	1	4750RCHD01AC1

Bolsa acolchado extraíble



4750RCHDW01AC2

	€		
120 x 280 x 525 mm	124,42	1	4750RCHDW01AC2

Candado TSA homologado para maleta 4750RCHD



4750RCHD-AC1

	€		
20 x 40 x 70 mm	37,97	1	4750RCHD-AC1

Foam para maleta 4750RCHD01, 64 piezas



FF2A07

	€		
45 x 330 x 430 mm	1.004,15	1	FF2A07

A6700DZ-1/2, A6700DZ-1/4, A6700DZ-11/32, A6700DZ-3/16, A6700DZ-3/8, A6700DZ-5/16, A6700DZ-7/16, A6700DZ-7/32, A6700DZ-9/16, A6700DZ-9/32

A6710DZ-3/8, A6710DZ-5/16, A6710DZ-7/16, A6710DZ-1/4		
A6800DZ-1/2, A6800DZ-1/4, A6800DZ-11/32, A6800DZ-3/16, A6800DZ-3/8, A6800DZ-5/16, A6800DZ-7/16, A6800DZ-7/32, A6800DZ-9/16, A6800DZ-9/32		
A7400DZ-1/2, A7400DZ-11/16, A7400DZ-13/16, A7400DZ-19/32, A7400DZ-3/4, A7400DZ-3/8, A7400DZ-5/8, A7400DZ-7/16, A7400DZ-7/8, A7400DZ-9/16		
A7402DZ-1/2, A7402DZ-11/16, A7402DZ-13/16, A7402DZ-19/32, A7402DZ-3/4, A7402DZ-3/8, A7402DZ-5/8, A7402DZ-7/16, A7402DZ-7/8, A7402DZ-9/16		
2058-BR		
6950SL		
6954		
6956		
6960, 6962, 6962L		
6966		
6972H		
7407H, 7408H		
7750SL		
7752		
7760, 7761, 7762		
7764		
7765		
7766		
8164-1/2		

Foam para maleta 4750RCHD01, 24 piezas



FF2A08

	€		
45 x 335 x 435 mm	447,64	1	FF2A08

1-100-04-2-2		
1-230-04-2-2		
111Z-1, 111Z-1/2, 111Z-1/4, 111Z-11/16, 111Z-3/4, 111Z-3/8, 111Z-5/16, 111Z-5/8, 111Z-7/16, 111Z-9/16, 111Z-7/8		
1177-SCRIBE		
1320RZ-1/2-9/16, 1320RZ-1/4-5/16, 1320RZ-3/8-7/16, 1320RZ-5/16-11/32		
1931Z-1/4, 1931Z-3/16, 1931Z-7/32		
1950MZ-3/8		
208		
9031 C		

Foam para maleta 4750RCHD01, 56 piezas



FF2A09

	€		
45 x 335 x 440 mm	517,04	1	FF2A09

BE-8040, BE-8210		
BE-8260		
BE-8600, BE-8610, BE-8620		
BE-9780		
MTB-3-16-E		
2047-1-5.5		
2047PR-1-2		
59/S28-4		
2509		
2535F2		
5515T-52		
808050		
1179-FLX-2, BFLA01		
BE-8150		

Foam para maleta 4750RCHD01, 15 piezas



FF2A10

	€		
49 x 330 x 435 mm	551,82	1	FF2A10

2101GC-160IP	
2427 GC-200IP	
2628 GC-160IP	
2632	
2650	
2855	
2979 D-180	
3625N-32	
3734-2, 3734-3, 3734-4, 3734-5	
3735-4-120	
481-300	
8224CIP	

Foam para maleta 4750RCHD01, 61 piezas



FF2B01

	€		
40 x 270 x 505 mm	971,98	1	FF2B01

A6700DZ-1/2, A6700DZ-1/4, A6700DZ-11/32, A6700DZ-3/16, A6700DZ-3/8, A6700DZ-5/16, A6700DZ-7/16, A6700DZ-7/32, A6700DZ-9/16, A6700DZ-9/32	
A6800DZ-1/2, A6800DZ-1/4, A6800DZ-11/32, A6800DZ-3/16, A6800DZ-3/8, A6800DZ-5/16, A6800DZ-7/16, A6800DZ-7/32, A6800DZ-9/16, A6800DZ-9/32	
A7400DZ-1/2, A7400DZ-1/4, A7400DZ-11/16, A7400DZ-17/32, A7400DZ-19/32, A7400DZ-3/4, A7400DZ-3/8, A7400DZ-5/16, A7400DZ-5/8, A7400DZ-7/16, A7400DZ-9/16	
A7402DZ-1/2, A7402DZ-1/4, A7402DZ-11/16, A7402DZ-19/32, A7402DZ-3/4, A7402DZ-3/8, A7402DZ-5/16, A7402DZ-5/8, A7402DZ-7/16, A7402DZ-9/16	
6950SL	
6954	
6956	
6958	
6960, 6961, 6962L	
6966	
6972H	
7407H	
7750SL	
7752	
7760, 7761, 7762	
7764	
7765	
7766	
8164-1/2	
U-S6106KA	

Foam para maleta 4750RCHD01, 69 piezas



FF2B02

	€		
39 x 270 x 505 mm	729,97	1	FF2B02

A6700DM-5.5, A6700DM-6, A6700DM-11, A6700DM-12, A6700DM-13, A6700DM-14, A6700DM-7, A6700DM-8, A6700DM-9, A6700DM-10	
A6800DM-6, A6800DM-7, A6800DM-8, A6800DM-9, A6800DM-4, A6800DM-5, A6800DM-5.5, A6800DM-14, A6800DM-10, A6800DM-11, A6800DM-12, A6800DM-13	
A7400DM-10, A7400DM-14, A7400DM-15, A7400DM-16, A7400DM-11, A7400DM-12, A7400DM-17, A7400DM-18, A7400DM-19, A7400DM-13	
A7402DM-19, A7402DM-15, A7402DM-16, A7402DM-17, A7402DM-18, A7402DM-11, A7402DM-12, A7402DM-13, A7402DM-14, A7402DM-10	
BE-9770	
111M-24, 111M-6, 111M-7, 111M-12, 111M-13, 111M-14, 111M-15, 111M-8, 111M-9, 111M-10, 111M-11, 111M-22, 111M-16, 111M-17, 111M-18, 111M-19	
4020L-M-5, 4020L-M-5.5	

Foam para maleta 4750RCHD01, 44 piezas



FF2B03

	€		
35 x 270 x 505 mm	796,43	1	FF2B03

A6710DM-7	
A6710DZ-1/2, A6710DZ-1/4, A6710DZ-11/32, A6710DZ-3/16, A6710DZ-3/8, A6710DZ-5/16, A6710DZ-7/16, A6710DZ-7/32, A6710DZ-9/16, A6710DZ-9/32	
BE-9780	
111Z-1, 111Z-1/2, 111Z-1/4, 111Z-11/16, 111Z-3/4, 111Z-3/8, 111Z-5/16, 111Z-5/8, 111Z-7/16, 111Z-7/8, 111Z-9/16, 111Z-13/16	
1320RZ-1/2-9/16, 1320RZ-1/4-5/16, 1320RZ-3/8-7/16, 1320RZ-5/16-11/32	
1931Z-1/4, 1931Z-3/16, 1931Z-7/32	
1950MZ-3/8	
2058-BR	



Foam para maleta 4750RCHDW01, 45 piezas



FF2B04

	€		
42 x 270 x 505 mm	450,70	1	FF2B04

BE-8020L, BE-8040		
BE-8080-10		
BE-8150, BE-8255		
BE-8610, BE-8620		
1544		
2509		
59/S28-4		
2535F2		
5516		
700-1.5-50, 700-1-50		
701-0-50, 701-00-50		
808050		
9070C		

Foam para maleta 4750RCHDW01, 15 piezas



FF2B05

	€		
35 x 270 x 510 mm	743,46	1	FF2B05

1150-1/2H/P	
MTB-3-16-M-E	
2101GC-125IP, 2101GC-160IP	
2427 GC-200IP	
2628 GC-160IP	
2650	
2820EF2	
2855	
4130	
4830	
5515T-52	
8224CIP	
BFLA01, 1179-FLX-2	

Foam para maleta 4750RCHDW01, 6 piezas



FF2B06

	€		
35 x 122 x 355 mm	107,02	1	FF2B06

3625N-32	
3734-5, 3734-8, 3734-3	
3735-5-120	
481-300	

Foam para maleta 4750RCHDW01, 62 piezas



FF2B07

	€		
35 x 270 x 505 mm	958,62	1	FF2B07

A6700DZ-1/2, A6700DZ-1/4, A6700DZ-11/32, A6700DZ-3/16, A6700DZ-3/8, A6700DZ-5/16, A6700DZ-7/16, A6700DZ-7/32, A6700DZ-9/16, A6700DZ-9/32	
A6710DZ-3/8, A6710DZ-5/16, A6710DZ-7/16	
A6800DZ-1/2, A6800DZ-1/4, A6800DZ-11/32, A6800DZ-3/16, A6800DZ-3/8, A6800DZ-5/16, A6800DZ-7/16, A6800DZ-7/32, A6800DZ-9/16, A6800DZ-9/32	
A7400DZ-1/2, A7400DZ-11/16, A7400DZ-13/16, A7400DZ-19/32, A7400DZ-3/4, A7400DZ-3/8, A7400DZ-5/8, A7400DZ-7/16, A7400DZ-7/8, A7400DZ-9/16	
A7402DZ-1/2, A7402DZ-11/16, A7402DZ-13/16, A7402DZ-19/32, A7402DZ-3/4, A7402DZ-3/8, A7402DZ-5/8, A7402DZ-7/16, A7402DZ-7/8, A7402DZ-9/16	
6950SL	
6954	
6956	
6960, 6962, 6962L	
6966	
6972H	

7407H, 7408H

7750SL

7752

7760, 7761, 7762

7764

7765

7766

8164-1/2

Foam para maleta 4750RCHDW01, 25 piezas



FF2B08

	€		
44 x 270 x 505 mm	447,85	1	FF2B08

1-100-04-2-2	
1-230-04-2-2	
111Z-1, 111Z-1/2, 111Z-1/4, 111Z-11/16, 111Z-3/4, 111Z-3/8, 111Z-5/16, 111Z-5/8, 111Z-7/16, 111Z-7/8, 111Z-9/16	
1177-SCRIBE	
1320RZ-1/2-9/16, 1320RZ-1/4-5/16, 1320RZ-3/8-7/16, 1320RZ-5/16-11/32	
1931Z-1/4, 1931Z-3/16, 1931Z-7/32	
1950MZ-3/8	
2058-BR	
208	
9031 C	

Foam para maleta 4750RCHDW01, 56 piezas



FF2B09

	€		
47 x 270 x 505 mm	532,97	1	FF2B09

BE-8040, BE-8210		
BE-8150		
BE-8260		
BE-8600, BE-8610, BE-8620		
BE-9780		

MTB-3-16-E	
2047-1-5.5	
2047PR-1-2	
2509	
2535F2	
5515T-52	
59/S28-4	
BFLA01, 1179-FLX-2	
808050	

Foam para maleta 4750RCHDW01, 9 piezas



FF2B10

	€		
37 x 270 x 505 mm	496,29	1	FF2B10

2101GC-160IP	
2427 GC-200IP	
2430 GC-200 IP	
2628 GC-160IP	
2650	
2744	
2855	
2979 D-180	
8224CIP	

Foam para maleta 4750RCHDW01, 7 piezas



FF2B11

	€		
39 x 122 x 355 mm	123,82	1	FF2B11

2632	
3625N-32	
3734-2, 3734-3, 3734-4, 3734-5	
481-300	

Foam para maleta 4750RCHDW01, 92 piezas



FF2B12

	€		
44 x 270 x 505 mm	1.081,98	1	FF2B12

A6800DM-6, A6800DM-7, A6800DM-8, A6800DM-9, A6800DM-5.5, A6800DM-10, A6800DM-11, A6800DM-12, A6800DM-13	
---	--

A7402DM-19, A7402DM-15, A7402DM-16, A7402DM-17, A7402DM-18, A7402DM-11, A7402DM-12, A7402DM-13, A7402DM-14, A7402DM-10	
--	--

6700SM-5.5, 6700SM-6, 6700SM-11, 6700SM-12, 6700SM-13, 6700SM-7, 6700SM-8, 6700SM-9, 6700SM-10	
--	--

6709M-3, 6709M-4, 6709M-5, 6709M-6, 6709M-8	
---	--

6709PH-1, 6709PH-2, 6709PH-3	
------------------------------	--

6709TORX-T20, 6709TORX-T25, 6709TORX-T27, 6709TORX-T30, 6709TORX-T8, 6709TORX-T9, 6709TORX-T10, 6709TORX-T15, 6709TORX-T40	
--	--

6954	
------	--

6956	
------	--

6958	
------	--

6960, 6961, 6962, 6962L	
-------------------------	--

6966	
------	--

6972H	
-------	--

7400SM-6, 7400SM-11, 7400SM-12, 7400SM-13, 7400SM-14, 7400SM-7, 7400SM-8, 7400SM-9, 7400SM-10, 7400SM-19, 7400SM-22, 7400SM-15, 7400SM-16, 7400SM-17, 7400SM-18	
---	--

7407H	
-------	--

7409M-8, 7409M-10, 7409M-4, 7409M-5, 7409M-6, 7409M-7, 7409M-3	
--	--

7409TORX-T25, 7409TORX-T27, 7409TORX-T30, 7409TORX-T40, 7409TORX-T45, 7409TORX-T50	
--	--

7750SL	
--------	--

7761, 7762, 7760	
------------------	--

7764	
------	--

7765	
------	--

7766	
------	--

8164-1/2	
----------	--

6950SL	
--------	--

Foam para maleta 4750RCHDW01, 39 piezas



FF2B13

	€		
50 x 270 x 505 mm	489,81	1	FF2B13

BE-9770	
---------	--

111M-12, 111M-13, 111M-14, 111M-15, 111M-8, 111M-9, 111M-10, 111M-11, 111M-6, 111M-7, 111M-21, 111M-22, 111M-16, 111M-17, 111M-18, 111M-19	
--	--

6M-6-7, 6M-8-9, 6M-10-11, 6M-12-13, 6M-14-15, 6M-16-17, 6M-18-19, 6M-20-22	
--	--

9070C	
-------	--

1177-SCRIBE	
-------------	--

2535F2	
--------	--

BFLA01	
--------	--

7758	
------	--

7754	
------	--

Foam para maleta 4750RCHDW01, 48 piezas



FF2B14

	€		
35 x 270 x 505 mm	342,44	1	FF2B14

BE-8020L, BE-8030	
-------------------	--

BE-8155	
---------	--

BE-8260	
---------	--

BE-8350	
---------	--

BE-8601, BE-8602	
------------------	--

BE-8610, BE-8620	
------------------	--

BE-8630	
---------	--

1544	
------	--

2047-0.8-4	
------------	--

2047PR-1-2	
------------	--

2058-BR	
---------	--

2509	
------	--

808050P	
---------	--

808050S	
---------	--

59S/31-1	
----------	--



Foam para maleta 4750RCHDW01, 9 piezas



FF2B15

35 x 270 x 505 mm € 343,35 1 FF2B15

1150-1/2H/P	
2101GC-160IP	
2427 GC-200IP	
2430 GC-200 IP	
2628 GC-160IP	
2820EF2	
5515T-52	
8224CIP	
MTB-3-16-M-E	

Foam para maleta 4750RCHDW01, 6 piezas



FF2B16

34 x 122 x 355 mm € 85,23 1 FF2B16

3625W-35	
3734-3, 3734-5, 3734-8	
3735-4-120	
481-300	

ARMARIOS Y PANELES

Armario con persiana 1495CS18 + 981001100, ganchos incluidos



1495CS18TS1

900 x 170 x 1800 mm € 2.227,89 1 1495CS18TS1

1495CS18	
981001100	
1495CS-AC1	
1495TP-AC10	

Armario con persiana 1495CS15 + 981001100, ganchos incluidos



1495CS15TS1

900 x 170 x 1500 mm € 2.111,19 1 1495CS15TS1

1495CS15	
981001100	
1495CS-AC1	
1495TP-AC10	

Armario con puertas 1495CD60 + 981001100, ganchos incluidos



1495CD60TS1

900 x 250 x 602 mm € 1.961,83 1 1495CD60TS1

1495CD60	
981001100	
1495CD-AC1	
1495TP-AC10	

Assortimento in millimetri in alloggiamento termoformato per le nostre valigie metalliche serie 1483K e 1483KHD, 12 pezzi



FF3A11



39 x 205 x 445 mm € 338,31 1 FF3A11







1150-1/2H/P	
MTB-3-16	
1177-SCRIBE	
2101GC-160IP	
2427 GC-200IP	
2430 GC-200 IP	
2628 GC-160IP	
3734-3, 3734-5, 3734-8	
3735-4-120	
8224CIP	

Assortimento in millimetri in alloggiamento termoformato per le nostre valigie metalliche serie 1483K e 1483KHD, 28 pezzi



FF3A12

  
45 x 205 x 450 mm 368,33 1 FF3A12







- 111M-6, 111M-21, 111M-19, 111M-18, 111M-22, 111M-13, 111M-12, 111M-11, 111M-10, 111M-17, 111M-16, 111M-15, 111M-14, 111M-9, 111M-8, 111M-7 
- 2820EF2 
- 5515T-52 
- 6M-10-11, 6M-6-7, 6M-12-13, 6M-8-9, 6M-14-15, 6M-16-17, 6M-18-19, 6M-20-22 
- BFLA01 
- 9070C 







Assortimento in millimetri in alloggiamento termoformato per le nostre valigie metalliche serie 1483K e 1483KHD, 49 pezzi



FF3A13

  
68 x 245 x 525 mm 673,95 1 FF3A13

- 111M-27, 111M-32, 111M-24, 111M-30 
- 6M-24-27, 6M-30-32 
- 7800SM-19, 7800SM-18, 7800SM-17, 7800SM-16, 7800SM-22, 7800SM-21, 7800SM-11, 7800SM-10, 7800SM-15, 7800SM-14, 7800SM-13, 7800SM-12, 7800SM-27, 7800SM-32, 7800SM-30, 7800SM-24 
- 7807H 
- 7809M-10, 7809M-12, 7809M-14, 7809M-19, 7809M-17, 7809M-5, 7809M-8, 7809M-6, 7809M-7 
- 7809TORX-T50, 7809TORX-T45, 7809TORX-T60, 7809TORX-T55, 7809TORX-T25, 7809TORX-T20, 7809TORX-T40, 7809TORX-T30, 7809TORX-T27 

























- 8150SL 
- 8164-1/2 
- 8154-11 
- 8160-5, 8160-10 
- 8171 
- 8166 
- 8172 

Assortimento in pollici in alloggiamento termoformato per le nostre valigie metalliche serie 1483K e 1483KHD, 77 pezzi



FF3A14

  
65 x 247 x 510 mm 917,32 1 FF3A14













- A6700DZ-1/2, A6700DZ-1/4, A6700DZ-3/8, A6700DZ-5/16, A6700DZ-7/16, A6700DZ-7/32, A6700DZ-9/16, A6700DZ-9/32, A6700DZ-11/32 
- A6800DZ-1/4, A6800DZ-5/16, A6800DZ-7/32, A6800DZ-9/32 
- A7400DM-10, A7400DM-13 
- A7400DZ-1/2, A7400DZ-11/16, A7400DZ-13/16, A7400DZ-3/4, A7400DZ-5/8, A7400DZ-7/8, A7400DZ-9/16 
- A7402DZ-1/2, A7402DZ-3/8, A7402DZ-7/16, A7402DZ-9/16 
- 111Z-1, 111Z-1.1/8 
- 59/S28-4 
- 6Z-1.1/16-1.1/4, 6Z-1.1-1/8 
- 6Z/8C 
- 6950SL 
- 6958 
- 6960, 6961 
- 6966 
- 6972H 
- 7407H, 7408H 
- 7750SL 
- 7752 
- 7760, 7761 
- 7764 
- 7765 
- 7766 
- 7800DZ-1, 7800DZ-15/16 
- 8164-1/2 
- 1952Z-15/16 
- 8171 

Assortimento in pollici in alloggiamento termoformato per le nostre valigie metalliche serie 1483K e 1483KHD, 14 pezzi



FF3A15

  
40 x 210 x 445 mm 259,59 1 FF3A15









- BE-3529 
- BE-8020L 
- BE-8155 
- BE-8260 
- BE-8601, BE-8602 
- BE-8611, BE-8621 
- 1177-SCRIBE 
- 2047-1.2-8 
- 2047PR-1-2 
- 5515T-52 
- 1179-FLX-2 
- 9715-14-250 

Assortimento in pollici in alloggiamento termoformato per le nostre valigie metalliche serie 1483K e 1483KHD, 12 pezzi



FF3A16

  
42 x 210 x 445 mm 461,17 1 FF3A16

- MTB-3-16-E 
- 2101GC-160IP 
- 2421GC-180IP 
- 3658A-3, 3658A-5, 3658A-8 
- 3735-5-120 
- 3740-150 
- 8224CIP 
- 2855 D 
- 0454800500, BFLB01 



Assortimento in pollici in alloggiamento termoformato per le nostre valigie metalliche serie 1483K e 1483KHD, 30 pezzi



FF3A17

48 x 205 x 450 mm	455,08	1 FF3A17

BE-9780	
KE18-01	
1300Z-1/4-5/16, 1300Z-3/8-7/16	
1320RZ-1/4-5/16, 1320RZ-3/8-7/16	
1931Z-1/4, 1931Z-7/32	
1952Z-1/2, 1952Z-11/16, 1952Z-11/32, 1952Z-13/16, 1952Z-3/4, 1952Z-5/8, 1952Z-7/8, 1952Z-9/16	
2628 GC-180IP	
7758	
U-DS2018A, U-XID1415A, U-XID1618A	

Composición 109 herramientas

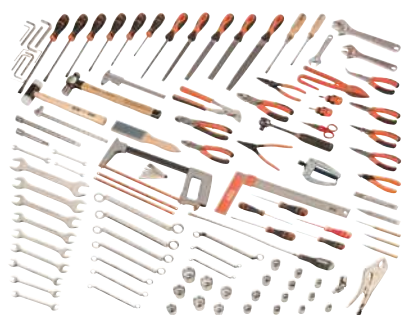

981001100

		€		
109	27 kg	1.539,57	1	981001100

1546	
2521GC-160	
2630GC-180IP, 2630GC-200IP	
6M-12-13, 6M-14-15, 6M-10-11, 6M-6-7, 6M-8-9, 6M-20-22, 6M-21-23, 6M-24-27, 6M-25-28	
8150RN-1/2	
8154-1/2, 2421GC-160, 8160-1/2, 8162-1/2, 8166-1/2	
9048-400	
9-469-00-0-0	
1998M/10T	
3733-4	

3734-4	
814-100	
815-2-25, 815-1-100, 815-2-125	
9710-8-150, 9710-6.5-125	
2101GC-200HL	
2800-180	
SC127	
1-100-08-2-2, 1-100-10-2-2	
1150-1/2H/P	
2101D-140IP	
2535F1	
3906-300-24-2P	
2951-250	
2M-6-7, 2M-8-9, 2M-10-11, 2M-12-13, 2M-14-15, 2M-16-17, 2M-18-19, 2M-20-22, 2M-21-23, 2M-24-27	
3645-150-C	
4544-10	
813-3-75, 813-4-100, 813-5.5-125	
1-230-08-1-2	
2430 GC-160 IP	
3735-4-120	
2900-180	
3625W-35	
479-16	
869102500	
1-170-08-2-2	
1-210-08-2-2	
8072 C, 8071 C	
225-PLUS	
2427 GC-200IP	
3640-150-C	
7800DM-18, 7800DM-17, 7800DM-16, 7800DM-11, 7800DM-10, 7800DM-15, 7800DM-14, 7800DM-13, 7800DM-12, 7800DM-19, 7800DM-23, 7800DM-22, 7800DM-21, 7800DM-20, 7800DM-24, 7800DM-26, 7800DM-28, 7800DM-30, 7800DM-32, 7800DM-27	
813VDE-3-100	
6224	

Panel de herramientas con persiana y ganchos



1495CS18HK

	€		
900 x 170 x 1800 mm	838,11	1	1495CS18HK
900 x 170 x 1800 mm	838,11	1	1495CS18BLHK

Armario con persiana



1495CS1

	€		
900 x 170 x 1500 mm	688,95	1	1495CS15
900 x 170 x 1800 mm	769,21	1	1495CS18
900 x 170 x 1500 mm	688,95	1	1495CS15BL
900 x 170 x 1800 mm	769,21	1	1495CS18BL

BK: negro / BL: Azul / RED: Rojo

Armario mural 2 puertas



1495CD60

	€		
900 x 250 x 602 mm	508,35	1	1495CD60

BK: negro / BL: Azul / RED: Rojo

Armario 2 puertas sobre ruedas



1495CD60W

	€		
1605 x 450 x 625 mm	1.056,83	1	1495CD60W

BK: negro / BL: Azul / RED: Rojo

Panel de herramientas con composición auto 62 piezas



1495TP-AUTO-M1

	€		
900 x 25 x 500 mm	1.174,42	1	1495TP-AUTO-M1

1495TP09	
BP910	
BP909TH	
BE-9678	
BE-9675	

29M-30	
2997-250	
1995LM-9, 1995LM-8, 1995LM-6	
3750	
1177-SCRIBE	
K7801M-9, K7801M-10, K7801M-11, K7801M-12, K7801M-13, K7801M-14, K7801M-15, K7801M-16, K7801M-17, K7801M-18, K7801M-19, K7801M-21, K7801M-22, K7801M-23, K7801M-24, K7801M-30, K7801M-32	
K7806M-15, K7806M-21, K7806M-24, K7806M-27	
K8901M-32, K8901M-34, K8901M-36	
K8964D	
K8167S	
K8160D-3	
2800-150	
2900-150	
3734S/6	
BE-8258TB	
1495TP-ACHL40x 9, 1495TP-ACHL65x 9, 1495TP-ACHL20x 33	

Panel de herramientas con composición auto 53 piezas



1495TP-AUTO-M2

	€		
900 x 25 x 500 mm	2.062,39	1	1495TP-AUTO-M2

1495TP09	
BE301	
K7801TORX-E10, K7801TORX-E12, K7801TORX-E14, K7801TORX-E16, K7801TORX-E18, K7801TORX-E20	
K8160D-2	
BE301CM	
BWHEPSSH8	
BE51038, BE510310, BE510312	
BP822	
BP825	
1495TP-ACHL40x 25, 1495TP-ACHL65x 4, 1495TP-ACHL20x 29	
1495TP-AC4	

Panel de herramientas con composición auto 34 piezas



1495TP-AUTO-M3

	€		
900 x 25 x 500 mm	1.145,77	1	1495TP-AUTO-M3

1495TP09	
BE1GP5-T	
6968	
BE1SP1F	
BE6OF108	
BE6307414F	
BE6OFW	
BE1FFWF	
BE63064514F1	
BE6810Z, BE6810	
BE6FCP	
52	
1546	
2421GC-160, 6962-W, 8166-1/2	
5515M	
BE1P	
7455-60	
BE1FLD2, BE1FLD1, BE1FLD3	
BE65F65120	
7764	
8164-1/2	
BE6302712F	
6954	
BE6701VAG	
BE62110	
BE1310P427	
7406ZZ-21, 7406ZZ-16	
BE1SP14L	
BE1GP5	
1495TP-AC3	
1495TP-ACHL20x 38, 1495TP-ACHL40, 1495TP-ACHL65	



Panel de herramientas con composición auto 23 piezas



1495TP-AUTO-M4



€



900 x 25 x 500 mm 1.455,13 1 1495TP-AUTO-M4

1495TP09	
BS618	
4545-N1, 4545-N11	
4545-1, 4545-2	
MTB-3-16	
361-14	
8900SM-41	
BS52	
8169-1/2, 8165-1/2	
747-22, 747-21, 747-19, 747-17, 747-15, 747-14, 747-13, 747-12	
BS40VAG	
BS56	
BS100PSA1	
BS45BMW	
1495TP-ACHL40x 10, 1495TP-ACHL65x 5, 1495TP-ACHL20x 20	

Panel de herramientas con composición auto 32 piezas



1495TP-AUTO-M5



€



900 x 25 x 500 mm 893,70 1 1495TP-AUTO-M5

1495TP09	
319	
484-1000	
SB3654BM-20	
3625S-44	
B192.004.200	
BE-8258TB	
2484/S4	
B194.030.150, B194.025.125, B194.020.100, B194.010.075	
600.005.012	
BBS165	
K7801TORX-E10, K7801TORX-E12, K7801TORX-E14, K7801TORX-E16, K7801TORX-E18, K7801TORX-E20, K7801TORX-E24	
BBR203P920, BBR203P925, BBR203P930, BBR203P940, BBR203P945, BBR203P950, BBR203P955, BBR203P960	
1495TP-ACHL40x 13, 1495TP-ACHL20x 38	
8226	

Panel de herramientas con composición auto 42 piezas

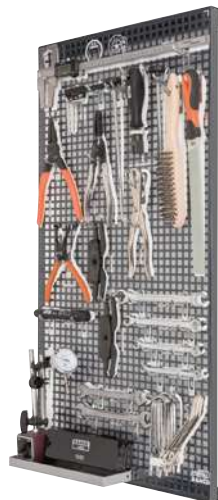

1495TP-AUTO-M6



€



900 x 25 x 500 mm 1.203,06 1 1495TP-AUTO-M6

1495TP09	
FM10	
782-U	
BBR405	
BBR400	
BBR210P3	
BBR6131	
BBR204	
BBR150I	

BBR501011, BBR50121314	
2900-215	
7823	
BBR100	
1154	
6M-16-17, 6M-14-15	
1949M-17-19, 1949M-12-13, 1949M-10-11, 1949M-8-9	
1495TP-ACHL40x 2, 1495TP-ACHL20x 29	
1495TP-AC3	

Panel de herramientas

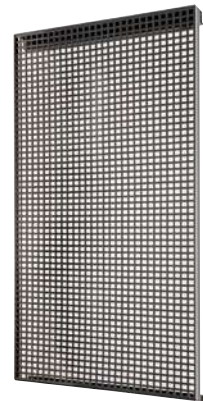

1495TP09



€



900 x 25 x 500 mm 116,78 1 1495TP09

Panel de herramientas

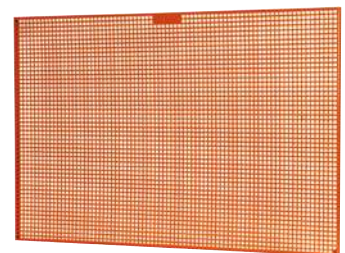

1495TP



€



500 x 23 x 600 mm	113,71	1	1495TP06
800 x 25 x 1200 mm	167,22	1	1495TP12
800 x 23 x 1500 mm	200,66	1	1495TP15
800 x 23 x 1800 mm	234,11	1	1495TP18
500 x 25 x 600 mm	113,71	1	1495TP06GR
800 x 25 x 1200 mm	167,22	1	1495TP12GR
800 x 25 x 1800 mm	234,11	1	1495TP18GR

GR: Gris

Rail para panel de herramientas
1495TP09



1495TP09-RAIL

 €  
40 x 57 x 440 mm 37,13 1 1495TP09-RAIL

Juego de ganchos - 35 piezas

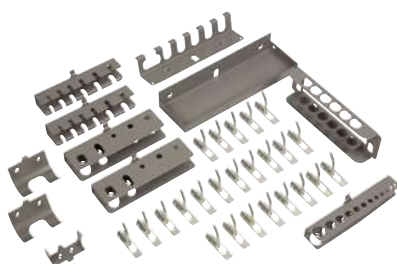

1495CS-AC1

 kg €  
2.11 kg 120,40 1 1495CS-AC1

Soporte para martillo 70x48x46mm



1495TP-AC12

 kg €  
0.07 kg 8,30 1 1495TP-AC12

Adaptadores para el panel y banco de trabajo



1495TP-AC1

 kg €  
9.5 kg 86,95 1 1495TP-AC1

Soporte para 12 llaves fijas - combinadas
.. 165x42x333mm



1495TP-AC10

 kg €  
0.43 kg 15,39 1 1495TP-AC10

Soporte para mango en T 56x37x27mm



1495TP-AC13

 kg €  
0.04 kg 9,70 1 1495TP-AC13

Juego de ganchos - 24 piezas

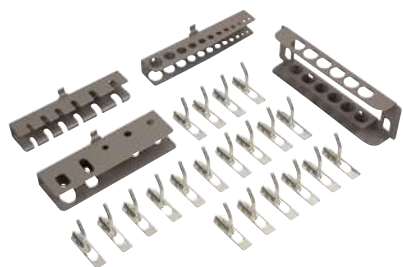

1495CD-AC1

 kg €  
1.22 kg 80,27 1 1495CD-AC1

Soporte para 6 botadores 213x30x65mm

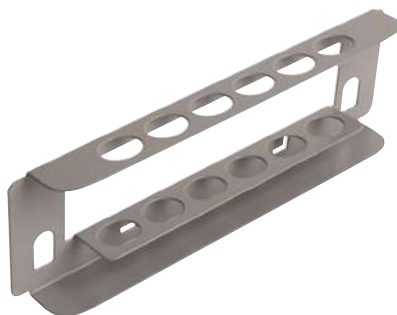

1495TP-AC11

 kg €  
0.16 kg 6,43 1 1495TP-AC11

Bandeja 238x125x40mm



1495TP-AC2

 kg €  
0.44 kg 12,04 1 1495TP-AC2



Juego de soporte y bandeja para vasos
260x80x40mm



1495TP-AC3

kg	€		
0.45 kg	16,38	1	1495TP-AC3

Bandeja de plástico 100x90x50mm



1495TP-AC4

kg	€		
0.125 kg	15,05	1	1495TP-AC4

Soporte para 6 destornilladores
166x30x26mm

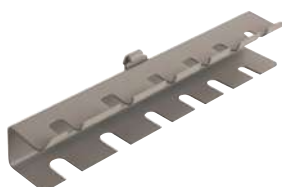

1495TP-AC5

kg	€		
0.14 kg	7,35	1	1495TP-AC5

Soporte para 5 alicates 175x55x26mm



1495TP-AC6

kg	€		
0.17 kg	7,63	1	1495TP-AC6

Soporte para Tenaza Grip 46x75x36mm



1495TP-AC7

kg	€		
0.79 kg	6,03	1	1495TP-AC7

Soporte para 12 llaves hexagonales
180x33x25mm



1495TP-AC8

kg	€		
0.12 kg	6,95	1	1495TP-AC8

Soporte para 12 llaves de tubo
74x50x398mm



1495TP-AC9

kg	€		
0.43 kg	16,72	1	1495TP-AC9

Ganchos para armarios y paneles (x5)



1495TP-ACH

kg	€		
0.116 kg	9,09	1	1495TP-ACHL20
0.125 kg	9,09	1	1495TP-ACHL40
0.144 kg	9,90	1	1495TP-ACHL65
0.17 kg	10,57	1	1495TP-ACHL90
0.102 kg	9,37	1	1495TP-ACHU20
0.125 kg	9,70	1	1495TP-ACHU40
0.146 kg	10,57	1	1495TP-ACHU65
0.162 kg	10,83	1	1495TP-ACHU90

Banco de trabajo de 180cm con encimera
de acero y cajonera lateral



1495KCWB18TS

	€		
1030 x 750 x 1800 mm	1.591,93	1	1495K6CWB18TS
1030 x 750 x 1800 mm	1.685,57	1	1495K7CWB18TS
1030 x 750 x 1800 mm	1.732,40	1	1495K8CWB18TS
1030 x 750 x 1800 mm	1.591,93	1	1495K6CBKWB18TS
1030 x 750 x 1800 mm	1.685,58	1	1495K7CBKWB18TS
1030 x 750 x 1800 mm	1.732,40	1	1495K8CBKWB18TS
1030 x 750 x 1800 mm	1.591,93	1	1495K6CBLWB18TS
1030 x 750 x 1800 mm	1.685,58	1	1495K7CBLWB18TS
1030 x 750 x 1800 mm	1.732,40	1	1495K8CBLWB18TS
1030 x 750 x 1800 mm	1.591,93	1	1495K6CRDWB18TS
1030 x 750 x 1800 mm	1.685,58	1	1495K7CRDWB18TS
1030 x 750 x 1800 mm	1.732,40	1	1495K8CRDWB18TS

Banco de trabajo de 150cm con encimera de acero y cajonera lateral



1495KCWB15TS

	€		
1030 x 750 x 1500 mm	1.525,04	1	1495K6CWB15TS
1030 x 750 x 1500 mm	1.618,69	1	1495K7CWB15TS
1030 x 750 x 1500 mm	1.665,51	1	1495K8CWB15TS
1030 x 750 x 1500 mm	1.525,04	1	1495K6CBKWB15TS
1030 x 750 x 1500 mm	1.618,69	1	1495K7CBKWB15TS
1030 x 750 x 1500 mm	1.665,51	1	1495K8CBKWB15TS
1030 x 750 x 1500 mm	1.525,04	1	1495K6CBLWB15TS
1030 x 750 x 1500 mm	1.618,69	1	1495K7CBLWB15TS
1030 x 750 x 1500 mm	1.665,51	1	1495K8CBLWB15TS
1030 x 750 x 1500 mm	1.525,04	1	1495K6CRDWB15TS
1030 x 750 x 1500 mm	1.618,69	1	1495K7CRDWB15TS
1030 x 750 x 1500 mm	1.665,51	1	1495K8CRDWB15TS

Kit de encimera de acero



1495KW-TS

	€		
1030 x 750 x 1500 mm	929,74	1	1495KWB15TS
1030 x 750 x 1800 mm	782,58	1	1495KWB18TS

Banco de trabajo de 180 cm con encimera de madera y cajonera lateral



1495KCWB18TW

	€		
1030 x 750 x 1800 mm	1.899,62	1	1495K6CWB18TW
1030 x 750 x 1800 mm	1.993,26	1	1495K7CWB18TW
1030 x 750 x 1800 mm	2.040,08	1	1495K8CWB18TW
1030 x 750 x 1800 mm	1.899,62	1	1495K6CBKWB18TW
1030 x 750 x 1800 mm	1.993,26	1	1495K7CBKWB18TW
1030 x 750 x 1800 mm	2.040,08	1	1495K8CBKWB18TW
1030 x 750 x 1800 mm	1.899,62	1	1495K6CBLWB18TW
1030 x 750 x 1800 mm	1.993,26	1	1495K7CBLWB18TW
1030 x 750 x 1800 mm	2.040,08	1	1495K8CBLWB18TW
1030 x 750 x 1800 mm	1.899,62	1	1495K6CRDWB18TW
1030 x 750 x 1800 mm	1.993,26	1	1495K7CRDWB18TW
1030 x 750 x 1800 mm	2.040,08	1	1495K8CRDWB18TW

Banco de trabajo de 150 cm con encimera de madera y cajonera lateral



1495KCWB15TW

	€		
1030 x 750 x 1500 mm	1.765,84	1	1495K6CWB15TW
1030 x 750 x 1500 mm	1.859,48	1	1495K7CWB15TW
1030 x 750 x 1500 mm	1.665,51	1	1495K8CWB15TW
1030 x 750 x 1500 mm	1.765,84	1	1495K6CBKWB15TW
1030 x 750 x 1500 mm	1.859,48	1	1495K7CBKWB15TW
1030 x 750 x 1500 mm	1.906,30	1	1495K8CBKWB15TW
1030 x 750 x 1500 mm	1.765,84	1	1495K6CBLWB15TW
1030 x 750 x 1500 mm	1.859,48	1	1495K7CBLWB15TW
1030 x 750 x 1500 mm	1.906,30	1	1495K8CBLWB15TW
1030 x 750 x 1500 mm	1.765,84	1	1495K6CRDWB15TW
1030 x 750 x 1500 mm	1.859,48	1	1495K7CRDWB15TW
1030 x 750 x 1500 mm	1.906,30	1	1495K8CRDWB15TW

Kit de Encimera de madera



1495KWB-TW

	€		
1030 x 750 x 1500 mm	1.130,40	1	1495KWB15TW
1030 x 750 x 1800 mm	1.331,07	1	1495KWB18TW

Banco de trabajo 1.800m con bandeja inferior



1495WB18TSBT

	€		
1030 x 750 x 1800 mm	941,72	1	1495WB18TSBT
1030 x 750 x 1800 mm	941,72	1	1495WB18TSBLBT

Banco de trabajo 1.500m con bandeja inferior



1495WB15TSBT

	€		
1030 x 750 x 1500 mm	663,06	1	1495WB15TSBT



Banco de trabajo con encimera de acero



1495WB-TS

	€		
1030 x 750 x 1500 mm	702,33	1	1495WB15TS
1030 x 750 x 1800 mm	782,58	1	1495WB18TS
1030 x 750 x 1800 mm	782,58	1	1495WB18TSBK
1030 x 750 x 1500 mm	648,16	1	1495WB15TSBL
1030 x 750 x 1800 mm	782,58	1	1495WB18TSBL
1030 x 750 x 1500 mm	702,33	1	1495WB15TSRED
1030 x 750 x 1800 mm	782,58	1	1495WB18TSRED

BK: negro / BL: Azul / RED: Rojo

Banco de trabajo con encimera de madera



1495WB-TW

	€		
1030 x 750 x 1500 mm	1.130,41	1	1495WB15TW
1030 x 750 x 1800 mm	1.290,93	1	1495WB18TW
1030 x 750 x 1500 mm	1.130,41	1	1495WB15TWGR
1030 x 750 x 1800 mm	1.290,93	1	1495WB18TWGR

GR: Gris

Bandeja inferior para bancos de trabajo



1495WB1-AC

	€		
30 x 504 x 1500 mm	140,46	1	1495WB15-AC1
30 x 504 x 1800 mm	167,22	1	1495WB18-AC1

GR: Gris

Cajoneras para bancos de trabajo



1495WB-AC

	€		
105 x 500 x 500 mm	127,09	1	1495WB-AC1

Banco de trabajo plegable con encimera de DM y chapa galvanizada



1495FWBTD

	€		
840 x 510 x 970 mm	529,53	1	1495FWB097TD
840 x 510 x 1200 mm	590,85	1	1495FWB120TD

Banco de trabajo plegable con encimera galvanizada



1495FWBTS

	€		
840 x 510 x 1200 mm	406,90	1	1495FWB120TS

CAJAS DE HERRAMIENTAS METÁLICAS

Caja metálica 1483KHD3RB con 129 herramientas



1483KHD3RB-FF1

	€		
335 x 260 x 565 mm	2.765,44	1	1483KHD3RB-FF1

1483KHD3RB

FF3A01

FF3A02

FF3A03

FF3A04

Caja metálica 1483KHD3RB con 144 herramientas



1483KHD3RB-FF2

	€		
335 x 260 x 565 mm	2.695,75	1	1483KHD3RB-FF2

1483KHD3RB

FF3A05

FF3A06

FF3A07

FF3A08

2509

2535F2

3625N-32

481-400

7762

Caja metálica 1483KHD3RB con 188 herramientas



1483KHD3RB-FF3



335 x 260 x 565 mm 2.639,30 1 1483KHD3RB-FF3

1483KHD3RB	
FF3A09	
FF3A10	
FF3A11	
FF3A12	

Caja metálica 1483KHD3RB con 142 herramientas



1483KHD3RB-FF4



335 x 260 x 565 mm 2.194,40 1 1483KHD3RB-FF4

1483KHD3RB	
FF3A10	
FF3A11	
FF3A12	
FF3A13	

Caja metálica 1483KHD3RB con 142 herramientas



1483KHD3RB-FF5

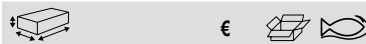

335 x 260 x 565 mm 2.637,69 1 1483KHD3RB-FF5

1483KHD3RB	
FF3A14	
FF3A15	
FF3A16	
FF3A17	

Caja metálica con 3 cajones y 124 htas.



1483KHD3RB-FF7



335 x 260 x 565 mm 2.005,10 1 1483KHD3RB-FF7

1483KHD3RB	
481-400	
2535F1	

7762	
6950SL	
6960, 6962	
6956	
7752	
6966	
6972H	
A6700DZ-3/16, A6700DZ-7/32, A6700DZ-1/4, A6700DZ-9/32, A6700DZ-5/16, A6700DZ-11/32, A6700DZ-3/8, A6700DZ-7/16, A6700DZ-1/2, A6700DZ-9/16	
A6710DZ-1/4, A6710DZ-5/16, A6710DZ-11/32, A6710DZ-3/8, A6710DZ-7/16	
A6800DZ-3/16, A6800DZ-7/32, A6800DZ-1/4, A6800DZ-9/32, A6800DZ-5/16, A6800DZ-11/32, A6800DZ-3/8, A6800DZ-7/16, A6800DZ-1/2, A6800DZ-9/16	
A6800DM-4	
BE-9780	
59/S28-4	
59S/TS-1/4	
9070 P	
808050	
2058-BR	
KE18-01	
1150-1/2H/P	
2047-1-5.5	
2047PR-1-2	
BE-8030	
BE-8150	
BE-8260	
BE-8350	
BE-8602	
BE-8610, BE-8620	
5515T-52	
1177-SCRIBE	
SR300-E	
704Z-3/32	
MTB-3-16-M-E	
2101GC-160IP	
2427 GC-200IP	
2855	
8224CIP	
2628 GC-160IP	
2632	
3734-3, 3734-5, 3734-8	
1300Z-1/4-5/16	
1320RZ-1/4-5/16, 1320RZ-3/8-7/16	
1952Z-15/16, 1952Z-1, 1952Z-1/4, 1952Z-5/16, 1952Z-11/32, 1952Z-3/8, 1952Z-7/16, 1952Z-1/2, 1952Z-9/16, 1952Z-5/8, 1952Z-11/16, 1952Z-3/4, 1952Z-13/16, 1952Z-7/8	
6Z-19/32-11/16	
3625N-32	



Caja metálica 4 cajones con tapa reforzada



1483KHD4RB

390 x 260 x 593 mm	15200 g	641,78	1	1483KHD4RB

Caja metálica 3 cajones



1483K3RB

334 x 260 x 523 mm	10200 g	401,93	1	1483K3RB

Foam para caja de herramientas 1483K y 1483KHD, 93 piezas



Caja metálica con 3 cajones y bandeja superior



1484THD3RB

300 x 220 x 520 mm	12.40 kg	483,90	1	1484THD3RB

Caja metálica 2 cajones



1483K2RB

277 x 257 x 525 mm	8200 g	330,61	1	1483K2RB

FF3A01

64 x 245 x 505 mm	968,17	1	FF3A01

A6700DZ-1/2, A6700DZ-1/4, A6700DZ-11/32, A6700DZ-3/8, A6700DZ-5/16, A6700DZ-7/16, A6700DZ-7/32, A6700DZ-9/32		
A6710DZ-3/8, A6710DZ-5/16, A6710DZ-7/16		
A6800DZ-1/4, A6800DZ-5/16, A6800DZ-7/32, A6800DZ-9/32		
A7400DM-10, A7400DM-13		
A7400DZ-1/2, A7400DZ-11/16, A7400DZ-3/4, A7400DZ-5/8, A7400DZ-9/16		
A7402DZ-1/2, A7402DZ-3/8, A7402DZ-7/16, A7402DZ-9/16		
1320RZ-1/4-5/16, 1320RZ-3/8-7/16		
59/S28-4		
6Z-1.1/16-1.1/4, 6Z-1-1.1/8, 6Z-7/8-15/16		
6950SL		
6956		
6958		
6960, 6961		
6966		
6972H		
7407H		
7750SL		
7752		
7760, 7761		
7764		
7765		
7766		
7800DZ-1, 7800DZ-13/16, 7800DZ-7/8		
8164-1/2		
8171		

Caja metálica 3 cajones con tapa reforzada



1483KHD3RB

305 x 233 x 523 mm	13050 g	544,54	1	1483KHD3RB

Carretilla para cajas metálicas 1483K



1483CART

200 x 270 x 655 mm	6.02 kg	209,80	1	1483CART

Foam para caja de herramientas 1483K y 1483KHD, 13 piezas



FF3A02

39 x 210 x 445 mm € 269,26 1 FF3A02

BE-3529		
BE-8020L	⊖	
BE-8155	⊖	
BE-8260	⊖	
BE-8601	⊕	
BE-8611, BE-8621	⊕	
1150-1/2H/P		
1177-SCRIBE		
2047-1.2-8	⊖	
2047PR-1-2	⊕	
5515T-52		
9715-14-250	⊖	

Foam para caja de herramientas 1483K y 1483KHD, 12 piezas



FF3A03

48 x 210 x 450 mm € 469,09 1 FF3A03

MTB-3-16-M-E		
2101GC-160IP		
2421GC-180IP		
2855 D		
3658A-2, 3658A-3, 3658A-5		
8224CIP	1€	
0454800500, 1151-1, 1151-2, BFLB01		

Foam para caja de herramientas 1483K y 1483KHD, 20 piezas



FF3A04

45 x 210 x 445 mm € 514,40 1 FF3A04

U-XID1415A, U-XID1618A, U-DS2018A		
1300Z-1/2-9/16, 1300Z-1/4-5/16, 1300Z-3/8-7/16, 1300Z-5/8-3/4, 1300Z-7/8-15/16, 1300Z-25/32-13/16, 1300Z-19/32-11/16		
6Z-19/32-11/16, 6Z-25/32-13/16, 6Z-3/8-7/16, 6Z-5/8-3/4, 6Z-1/4-5/16, 6Z-1/2-9/16		
9070C		
1931Z-7/32, 1931Z-1/4		
8157-15		

Foam para caja de herramientas 1483K y 1483KHD, 95 piezas



FF3A05

60 x 245 x 510 mm € 1.071,23 1 FF3A05

A6700DZ-1/2, A6700DZ-1/4, A6700DZ-11/32, A6700DZ-3/8, A6700DZ-5/16, A6700DZ-7/16, A6700DZ-7/32, A6700DZ-9/16, A6700DZ-9/32		
A6710DZ-1/4, A6710DZ-11/32, A6710DZ-3/8, A6710DZ-5/16, A6710DZ-7/16		
A6800DM-4		
A6800DZ-1/2, A6800DZ-1/4, A6800DZ-11/32, A6800DZ-3/8, A6800DZ-5/16, A6800DZ-7/16, A6800DZ-3/16, A6800DZ-7/32, A6800DZ-9/16, A6800DZ-9/32		

A7400DZ-1/2, A7400DZ-11/16, A7400DZ-13/16, A7400DZ-17/32, A7400DZ-19/32, A7400DZ-3/4, A7400DZ-5/8, A7400DZ-9/16

59/S28-4		
BE-9780	⊖	
KE18-01		
1544		
2058-BR		
59S/TS-1/4	⊕	
6950SL		
6956		
6960, 6962		
6966		
6972H		
7407H		
7752		
7750SL		
7760, 7761		
7764		
7765		
7766		
808050	⊖	
9071C		
8164-1/2		

Foam para caja de herramientas 1483K y 1483KHD, 15 piezas



FF3A06

40 x 205 x 450 mm € 286,15 1 FF3A06

BE-8030	⊖	
BE-8150, BE-8155	⊖	
BE-8260	⊖	
BE-8350	⊖	
BE-8602	⊕	
BE-8610, BE-8620	⊕	
1177-SCRIBE		
2047-1-5.5	⊖	
2047PR-1-2	⊕	
5515T-52		
704Z-3/32	⊖	
1150-1/2H/P		
1179-FLX-2		



Foam para caja de herramientas 1483K y 1483KHD, 11 piezas



FF3A07

	€		
39 x 202 x 450 mm	467,57	1	FF3A07

MTB-3-16-E	
2101GC-160IP	
2427 GC-200IP	
2628 GC-160IP	
2632	
2650	
2855	
3734-3, 3734-5, 3734-8	
8224CIP	

Foam para caja de herramientas 1483K y 1483KHD, 23 piezas



FF3A08

	€		
43 x 205 x 450 mm	371,79	1	FF3A08

1320RZ-1/2-9/16, 1320RZ-5/16-11/32, 1320RZ-1/4-5/16, 1320RZ-3/8-7/16	
1952Z-1/2, 1952Z-1/4, 1952Z-11/16, 1952Z-11/32, 1952Z-13/16, 1952Z-3/4, 1952Z-3/8, 1952Z-5/16, 1952Z-5/8, 1952Z-7/16, 1952Z-7/8, 1952Z-9/16	
6Z-19/32-11/16, 6Z-1/2-9/16, 6Z-1/4-5/16, 6Z-13/16-7/8, 6Z-3/8-7/16, 6Z-5/16-11/32, 6Z-5/8-3/4	

Foam para caja de herramientas 1483K y 1483KHD, 95 piezas



FF3A09

	€		
65 x 250 x 515 mm	1.122,25	1	FF3A09

A6800DM-7, A6800DM-6, A6800DM-5.5, A6800DM-11, A6800DM-10, A6800DM-9, A6800DM-8, A6800DM-13, A6800DM-12	
A7402DM-19, A7402DM-18, A7402DM-17, A7402DM-12, A7402DM-11, A7402DM-10, A7402DM-16, A7402DM-15, A7402DM-14, A7402DM-13	
1544	
2058-BR	
6700SM-8, 6700SM-7, 6700SM-6, 6700SM-5.5, 6700SM-12, 6700SM-11, 6700SM-10, 6700SM-9, 6700SM-13	
6709M-8, 6709M-6, 6709M-5, 6709M-4, 6709M-3	
6709PH-2, 6709PH-1, 6709PH-3	
6709TORX-T25, 6709TORX-T20, 6709TORX-T15, 6709TORX-T10, 6709TORX-T40, 6709TORX-T30, 6709TORX-T27, 6709TORX-T9, 6709TORX-T8	
6950SL	
6954	
6956	
6958	
6960, 6961, 6962, 6962L	
6966	
6972H	
7400SM-8, 7400SM-7, 7400SM-6, 7400SM-19, 7400SM-18, 7400SM-17, 7400SM-22, 7400SM-12, 7400SM-11, 7400SM-10, 7400SM-9, 7400SM-16, 7400SM-15, 7400SM-14, 7400SM-13	
7407H	
7409M-10, 7409M-8, 7409M-7, 7409M-6, 7409M-5, 7409M-4, 7409M-3	
7409TORX-T27, 7409TORX-T25, 7409TORX-T50, 7409TORX-T45, 7409TORX-T40, 7409TORX-T30	
7750SL	
7754	
7758	
7760, 7761	
7764	
7765	
7766	
8164-1/2	

Foam para caja de herramientas 1483K y 1483KHD, 53 piezas



FF3A10

	€		
39 x 205 x 445 mm	254,58	1	FF3A10

BE-8020L, BE-8030	
BE-8155	
BE-8260	
BE-8350	
BE-8601, BE-8602	
BE-8610, BE-8620	
BE-9770	
2047-0.8-4	
2047PR-1-2	
808050P	
808050S	
59S/31-1	

Caja metálica con 69 herramientas en foam



3149-ORFF1

	€		
220 x 220 x 560 mm	561,43	1	3149-ORFF1

111M-19, 111M-18, 111M-17, 111M-16, 111M-15, 111M-14, 111M-13, 111M-12, 111M-11, 111M-10, 111M-8, 111M-9	
2953-250	
224 D	
2171G-160	
2470 G-200	
BE-9770	
611-3.5-75, 611-5.5-125, 611-6.5-150	
613-3-100, 613-4-125	
615-2-25, 615-1-100, 615-2-125, 615-3-150	
KBSK-01	
MTG-5-19-E	
482-30	
3625W-28	

3745-150	
3740-150	
3734-3, 3734-5	
3735-5-120	
3149-OR	
2678 G-200	
8160-10, 8160-5	
8158-10	
SBS81	
8166	
7772H	
7800SM-15, 7800SM-16, 7800SM-13, 7800SM-14, 7800SM-19, 7800SM-20, 7800SM-17, 7800SM-18, 7800SM-23, 7800SM-24, 7800SM-21, 7800SM-22, 7800SM-27, 7800SM-32, 7800SM-30, 7800SM-11, 7800SM-12, 7800SM-10	

Caja metálica con 69 herramientas



3149-ORTS1

	€		
220 x 220 x 560 mm	372,38	1	3149-ORTS1

111M-19, 111M-18, 111M-17, 111M-16, 111M-15, 111M-14, 111M-13, 111M-12, 111M-11, 111M-10, 111M-9, 111M-8	
--	--

S240	
2953-250	
224 D	
2171G-160	
2678 G-200	
2470 G-200	
BE-9770	
611-3.5-75, 611-5.5-125, 611-6.5-150	
613-3-100, 613-4-125	
615-2-25, 615-1-100, 615-2-125, 615-3-150	
KBSK-01	
MTG-5-19-E	
482-30	
3625W-28	
3745-150	
3740-150	
3734-3, 3734-5	
3735-5-120	
3149-OR	

Caja metálica con ruedas



1497MBW

		€		
549 x 400 x 1213 mm	250 kg	573,39	1	1497MBW

Caja de herramientas para taller



3149-OR

		€		
200 x 220 x 530 mm	4370 g	45,14	1	3149-OR

Caja de herramientas con 7 compartimentos



1497MBF750

		€		
250 x 200 x 530 mm	15 kg	78,50	1	1497MBF750

Caja de herramientas con 5 compartimentos



1497MBF550

		€		
200 x 200 x 530 mm	12 kg	69,78	1	1497MBF550

Caja de herramientas con 3 compartimentos



1497MBF350

		€		
160 x 200 x 530 mm	10 kg	57,90	1	1497MBF350

Caja de herramientas metálica



9601

		€		
190 x 210 x 300 mm	2450 g	37,08	1	960100010
190 x 210 x 400 mm	3400 g	40,16	1	960100020
190 x 210 x 500 mm	3670 g	43,65	1	960100030
245 x 210 x 400 mm	4400 g	51,36	1	960100050
245 x 210 x 500 mm	4840 g	55,58	1	960100060



Caja metálica de albañil



1496MB2

		€		
290 x 290 x 530 mm	40 kg	130,20	1	1496MB2

Caja metálica de albañil



1496MB5

		€		
530 x 530 x 910 mm	150 kg	302,36	1	1496MB5

Caja metálica de albañil



1496MB3

		€		
310 x 360 x 690 mm	60 kg	155,02	1	1496MB3

Caja metálica de albañil



1496MB4

		€		
340 x 440 x 830 mm	80 kg	186,02	1	1496MB4

CAJAS Y ESTUCHES DE PLÁSTICO

Caja de herramientas de plástico con 37 htas. uso general



4750PTB65TS5

	€		
285 x 300 x 650 mm	223,43	1	4750PTB65TS5

2430 D-140 IP	
2630D-160	
MT-TS-3	
9572	
BE-9884	
2446	
SL25	
427-16	

Caja de herramientas de plástico sobre ruedas



4750PTBW67

		€		
420 x 472 x 675 mm	50 kg	98,73	1	4750PTBW67

Maletín con llave dinamométrica ajustable y juego de herramientas de impacto - 11 piezas



4750BMC10FF1

	€		
84 x 341 x 447 mm	494,40	1	4750BMC10FF1

4750BMC10	
BWSHK21	
BWSMB15	
BWSMB17	
BWSS12P5	
BWTVCTT355	
74W9-200	
9R-1/2	

Maleta trolley de polipropileno



4750PTBW47

		€		
60 l	30 kg	78,26	1	4750PTBW47

Caja de herramientas de plástico



4750PTB65

	€		
285 x 300 x 650 mm	62,17	2	4750PTB65

Caja plástico con asa 600x305x295



4750PTB60

		€		
37 l	20 kg	55,38	3	4750PTB60

Caja plástico con asa 500x295x270



4750PTB50

		€		
27 l	20 kg	48,15	3	4750PTB50

Caja de plástico



4750BMC

	€		
51 x 117 x 260 mm	5,06	1	4750BMC3
67 x 214 x 230 mm	9,11	1	4750BMC4
70 x 230 x 280 mm	12,39	1	4750BMC5
90 x 230 x 320 mm	13,75	1	4750BMC5.5
93 x 257 x 357 mm	15,93	1	4750BMC6
76 x 256 x 355 mm	16,41	1	4750BMC7
80 x 287 x 380 mm	16,76	1	4750BMC9
105 x 297 x 393 mm	21,13	1	4750BMC9.5
84 x 341 x 450 mm	22,43	1	4750BMC10

EQUIPOS TEXTILES Y DE PIEL

Bolsa 4750FB2W-24A con 72 herramientas



4750FB2W-TS001

	€		
390 x 400 x 685 mm	670,28	1	4750FB2W-TS001

4750FB2W-24A		
SL25		
BE-8030, BE-8242		
S240		
BE-8155		
BE-8600, BE-8610, BE-8620		
BE-8800, BE-8810, BE-8820		
BE-8040S		
2628 G-180		

2101G-180		
7224		
1520 G		
MTB-5-25		
MA421		
268		
325		
479-16		
KERU-01		
BFLA01		
5515T		
9071		

Bolsa 4750FB2-19A con 61 herramientas para mantenimiento



4750FB2-19TS001

		€		
500 mm	250 mm	560,68	1	4750FB2-19TS001

4750FB2-19A		
BE-8010S, BE-8040S, BE-8050S, BE-8220S		
BE-8610S, BE-8620S, BE-8630S		
BE-8800S, BE-8820S, BE-8830S		
706-4		
PC-12-VEN		
1-210-08-2-2		
2101G-180		
2233 D-200		
2628 G-180		
268		
3830-20-VIP, 3830-25-VIP		
3834-ARBR-730		
4130		
424P-16, 424P-20, 424P-25		
428-16		
484-1250		
806-1-1		
8231		
9031		
SL25		



Bolsa 4750FB4-18 con 32 herramientas



4750FB4-18TS001

		€		
450 mm	190 mm	745,29	1	4750FB4-18TS001

4750FB4-18	
2101G-160	
2628 G-180	
2430 G-160	
1RM/SH8	
7223	
2233 D-200	
SL25	
9070	
9031	
483-20	
BE-8020, BE-8040	
BE-8150, BE-8155	
BE-8610, BE-8620	
SC127	
SQZ150003	
BE-9777	
MTB-5-25	

Juego de herramientas para electricista, 28 herramientas



3049-2

	€		
180 x 435 x 270 mm	538,96	1	3049-2

268	
5470-140	
111M-7, 111M-8, 111M-10, 111M-13	
2744	
2427 S-200	
8045LVDE	
BE-9765	
2705R	
481-300	
9072 P	
2628 S-180	
2101S-160	
BE-8820S	
BE-8220S, BE-8040S, BE-8050S, BE-8255S	
BE-8610S, BE-8620S	
B146.006.100	
4750-FOLTTC-1	

Maleta de cuero con 16 herramientas para electricista



982000170

	€		
290 x 195 x 440 mm	574,17	1	982000170

Dotación: TS100

4750-FOLTTC-1	
2101GC-160IP	
2800 N	
2630GC-160IP	
2421GC-160	
2521GC-160	
8071 C IP	
B196.065.150, B196.055.125, B196.030.100, B196.040.100	
B197.002.100, B197.001.080	
SC127	
2820EF2	
MTB-3-16	
6224	

Maleta cuero con dotación universal 32 htas



982000320

	€		
280 x 200 x 435 mm	574,17	1	982000320

4750-FOLTTC-1	
2101D-160IP	
224 D	
2630D-180	
2430 D-160 IP	
8071 C IP	
483-20	
6M/8C	
541D-180	
2951-180	
B191.030.075, B191.040.100	
B190.100.200, B190.065.150	
B192.001.100, B192.002.125	
SC127	
2820EF2	
BE-9777	
MTB-3-16	

Maleta de cuero con dotación 34 herramientas electro-mecánico



982000350

	€		
280 x 200 x 440 mm	647,02	1	982000350

Dotación: TS002

4750-FOLTTC-1	
2101GC-160IP	
2630GC-180IP	

2900-180	
2800-180	
1998M/10T	
8072 C IP	
2951-250	
B190.100.200, B190.065.150, B190.040.100	
B192.001.100, B192.002.125	
SC127	
6M/8C	
479-16	
2430 GC-200 IP	
1-110-08-2-2	
6224	

Estuche porta herramientas con 51 piezas, en foam



4750FB5BFF1	
62 x 275 x 330 mm	€ 194,78 1 4750FB5BFF1

4750FB5B	
808050P	
MTB-5-25	
2101G-160	
2628 G-180	
BE-9578	
9070	
59/S31B	

Estuche porta herramientas con 36 piezas



4750FB5ATS001	
275 mm 170 mm	€ 131,76 1 4750FB5ATS001

4750FB5A	
2058/S26	
808050	
8070	
2101G-160	
2628 G-180	

Juego/herramientas: electrónica, Alicates



9848	
50 x 275 x 330 mm	€ 159,03 1 9848

8160	
7890	
8070	
BE-8020, BE-8040	
BE-8610	
TL AA-SA-SL	

Juego de herramientas para electrónica



9852	
360 x 40 x 240 mm	€ 370,64 1 9852

7890	
8160	
8070	
TL AA-SA-SL	

2421 G-160	
2101G-160	
2628 G-180	
BE-8210, BE-8040	
BE-8150, BE-8155	
BE-8600, BE-8610, BE-8620	
8045LVDE	
K-AP-1	

Juego de herramientas para electrónica



9841	
275 x 48 x 330 mm	€ 176,37 1 9841

7190	
7890	
TL AA-SA-SL	
BE-8020, BE-8040	
BE-8610	
8070	

Mochila para electricistas



4750FB8	
560 x 190 x 335 mm	€ 100,73 4 4750FB8



Bolsa de herramientas



3100TB

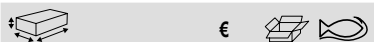

345 x 240 x 485 mm € 61,13 1 3100TB

Bolsa de 19" con cremallera



4750FB2-19A



370 x 230 x 470 mm € 64,91 4 4750FB2-19A

Portaherramientas para electricista de 12"



4750FB3-12

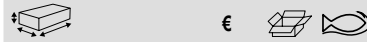

285 x 190 x 285 mm € 79,72 1 4750FB3-12

Bolsa abierta de 19"



4750FB1-19A



355 x 230 x 470 mm € 78,60 1 4750FB1-19A

Bolsa de 24" con cremallera



4750FB2-24A



380 x 260 x 600 mm € 97,51 2 4750FB2-24A

Bolsa de 18" para ordenador portátil y herramientas



4750FB4-18

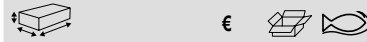

350 x 150 x 430 mm € 109,64 4 4750FB4-18

Bolsa abierta de 19" con cubierta



4750FB1-19B

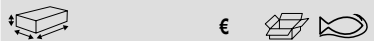

365 x 225 x 480 mm € 107,25 4 4750FB1-19B

Bolsa de 24" sobre ruedas



4750FB2W-24A



385 x 325 x 665 mm € 192,45 1 4750FB2W-24A

Bolsas portaherramientas textiles con parte superior cerrada de 21 l



4750FB6-13

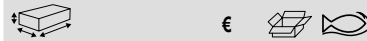

275 x 250 x 310 mm € 19,20 1 4750FB6-13

Bolsas portaherramientas textiles con parte superior cerrada de 36 l



4750FB6-19



€



1 4750FB6-19

290 x 265 x 480 mm

26,09

Estuche porta herramientas mediano



4750FB5B



€



1 4750FB5B

62 x 275 x 330 mm

18,67

Porta herramientas compatible con 2 foams 1/3



4750FB5-FG2



€



1 4750FB5-FG2

90 x 210 x 470 mm

22,10

Bolsa para juego de niveles 416-SET



4750-LV-1



€



1 4750-LV-1

85 x 43 x 1800 mm

10,86

51 x 43 x 1800 mm

10,87

1 4750-LV-2

Estuche porta herramientas grande



4750FB5C



€



8 4750FB5C

80 x 305 x 403 mm

24,36

Caja de herramientas de cuero de apertura frontal



4750-FOLTC-1



€



1 4750-FOLTC-1

290 x 195 x 440 mm

171,29

Estuche porta herramientas pequeño



4750FB5A



€



1 4750FB5A

50 x 168 x 273 mm

10,63

Porta herramientas compatible con 1 foam 1/3



4750FB5-FG1



€



1 4750FB5-FG1

65 x 210 x 470 mm

19,11

Maletín para herramientas tubular



4750-TOCST-1



€



1 4750-TOCST-1

220 x 170 x 495 mm

64,74



Maleta de cuero para electricista



4750-VDEC

	€		
290 x 190 x 445 mm	252,79	1	4750-VDEC

Juego de 3 bolsas pequeñas con cremallera



4750FB7-01

	€		
135 x 10 x 215 mm	22,23	60	4750FB7-01

Juego de 3 bolsas grandes con cremallera



4750FB7-02

	€		
205 x 10 x 310 mm	26,29	60	4750FB7-02

Estuche con cremallera, pequeño



4750FB7ORLT

	€		
135 x 10 x 215 mm	7,85	120	4750FB7ORLT

Estuche con cremallera, grande



4750FB7ORBG

	€		
205 x 10 x 310 mm	8,99	120	4750FB7ORBG

Cinturón reforzado y acolchado con hebilla de acero inoxidable de doble pitón.



4750-HDB-2

	€		
190 x 50 x 900 mm	51,11	1	4750-HDB-2

Cinturón portaherramientas profesional



4750-HDBS-2

	€		
330 x 170 x 900 mm	162,30	1	4750-HDBS-2

Cinturón ajustable de zafado rápido en tejido muy resistente



4750-QRFB-1

	€		
50 x 4 x 1180 mm	21,25	1	4750-QRFB-1

Cinturón portaherramientas con tres bolsillos Junior



4750-JU3PB

	€		
125 x 55 x 395 mm	35,63	1	4750-JU3PB-1

Cinturón de cuero resistente



4750-HDLB

	€		
47 x 4 x 1380 mm	32,02	1	4750-HDLB-1

Bolsa con dos bolsillos



4750-2PP

	€		
285 x 130 x 265 mm	45,05	1	4750-2PP-1

Soporte porta herramientas multi uso



4750-MPH-1

	€		
240 x 50 x 155 mm	28,03	1	4750-MPH-1

Portaherramientas enrollable



4750-ROCO-1

	€		
320 x 5 x 370 mm	20,70	1	4750-ROCO-1

Porta taladro para diestros y zurdos



4750-DHO-3

	€		
320 x 73 x 175 mm	34,27	1	4750-DHO-3

Funda para cutter de hoja deslizante



4750-KNHO-1

	€		
205 x 35 x 105 mm	18,21	1	4750-KNHO-1

Rodilleras con almohadillas



4750-KP

	€		
200 x 30 x 170 mm	44,43	1	4750-KP-1

Portaherramientas electricista



4750-EP

	€		
345 x 120 x 260 mm	56,64	1	4750-EP-1

Funda vertical para móvil



4750-VMPH-1

	€		
170 x 35 x 100 mm	22,40	1	4750-VMPH-1

Tirantes con pinzas



4750-BWC-1

	€		
750 x 20 x 105 mm	29,08	1	4750-BWC-1





BAHCO

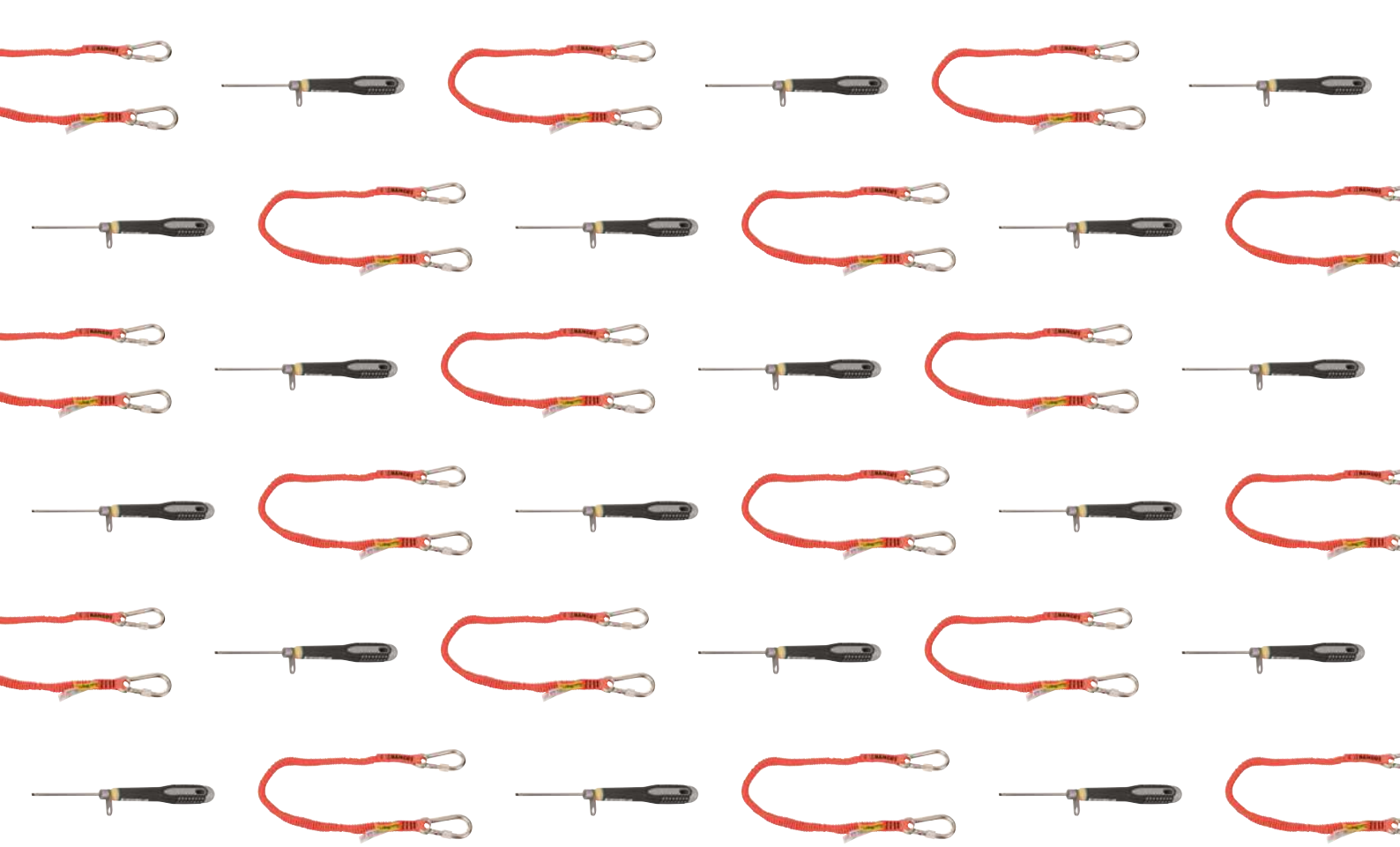

Herramientas para trabajos en altura



ALMACENAMIENTO DE HERRAMIENTAS Y CORDONES

Lanyard para 1Kg con mosquetones giratorios



3875-LY60



g	€		
135 g	19,82	1	3875-LY60

Cordón flexible máx 1kg largo 65cm



3875-LY3

g	€		
125 g	39,25	8	3875-LY3

Longitud máx.: 120cm

Cordón para muñecas (1daN) 60cm



3875-WL1

g	€		
40 g	25,62	8	3875-WL1

Cordón conector para 3875-LY3 o 3875-WL1



3875-QL1

g	€		
40 g	15,01	8	3875-QL1

Cordón flexible máx 0.9Kg



3875-RL1

g	€		
200 g	68,07	1	3875-RL1

Longitud máx 100cm

Cordón conector para 3875-RL1



3875-QRL1

g	€		
40 g	19,56	1	3875-QRL1

Lanyard para 1Kg retráctil



3875-RL2

g	€		
212 g	68,32	1	3875-RL2

Lanyard para 3Kg con mosquetones fijos



3875-LY70



g	€		
172 g	24,87	1	3875-LY70

Lanyard para 3 Kg



3875-LY4



g	€		
180 g	40,77	8	3875-LY4

Cordón con mosquetón 80cm para máx 3kg



3875-LY1

g	€		
170 g	39,25	8	3875-LY1

Longitud máx.: 120cm

Cuerda de seguridad flexible con mosquetón fijo (3daN)



3875-LY2

g	€		
120 g	39,25	8	3875-LY2

Largura 80cm, máx 120cm

Lanyard para 6Kg con mosquetones fijos



3875-LY8



	€		
330 g	57,38	1	3875-LY8

Lanyard espiral 1.7mm



439000001

	€		
130 g	12,91	1	439000001

Lanyard para 3Kg con mosquetones giratorios



439000003



	€		
160 g	23,42	1	439000003

Lanyard para 12Kg con mosquetones fijos



3875-LY10



	€		
270 g	68,32	1	3875-LY10

Cuerda de acero



3875-SL1

	€		
10 g	0,68	1	3875-SL1

Cordones lanyard naranjas de alta visibilidad con clip de plástico



439000004

	€		
13 g	7,11	1	439000004

Porta herramientas hasta 25kg



439000000

	€		
100 g	12,76	1	439000000

Lanyard para 2Kg con mosquetones giratorios



439000002

	€		
130 g	20,51	1	439000002

Bolsa para trabajos en altura, 10 litros, carga máxima de 1Kg



3875-HB10

	€		
260 x 130 x 130 mm	8,88	1	3875-HB10



Bolsa colgante para 30 y 60 litros



3875-HB30/3875-HB60



Icono	€	Icono	Icono
270 x 270 x 330 mm	91,26	1	3875-HB30
340 x 340 x 620 mm	114,12	6	3875-HB60

Mochila grande con múltiples compartimentos



3875-BP2



Icono	€	Icono	Icono
240 x 340 x 440 mm	127,81	8	3875-BP2

Bolsa universal



4750-UP-2

Icono	€	Icono	Icono
270 x 145 x 270 mm	60,79	1	4750-UP-2

Bolsa 100 l. para trabajos en altura



3875-HB100



Icono	€	Icono	Icono
390 x 390 x 890 mm	184,46	1	3875-HB100

Bolsa con 6 ganchos



3875-MHP6

Icono	€	Icono	Icono
100 x 185 x 370 mm	90,80	1	3875-MHP6

Soporte para martillo



4750-HHO-2

Icono	€	Icono	Icono
110 x 65 x 165 mm	21,47	1	4750-HHO-2

Bolsa para maleta rígida



3875-SB70



Icono	€	Icono	Icono
790 x 300 x 750 mm	252,78	1	3875-SB70

Jgo de cinturón con 3 bolsas



3PB-2

Icono	€	Icono	Icono
80 x 270 x 1350 mm	129,33	1	4750-3PB-2

Cinturón de cuero resistente



4750-HDLB-TAH

Icono	€	Icono	Icono
50 x 120 x 1410 mm	61,58	1	4750-HDLB-TAH

LLAVES

Llave ajustable serie 90



ergo



TAH90



L	W	€	Box	Key
158mm/6"	20 mm	44,59	1	TAH9070
250mm/10"	31 mm	63,04	1	TAH9072

Llave ajustable serie 80



TAH80



L	W	€	Box	Key
110mm/4"	13 mm	52,65	1	TAH8069
155mm/6"	20 mm	50,69	1	TAH8070
205mm/8"	27 mm	54,69	1	TAH8071
255mm/10"	31 mm	50,79	1	TAH8072
305mm/12"	34 mm	73,78	1	TAH8073
380mm/15"	44 mm	120,60	1	TAH8074
460mm/18"	53 mm	189,48	1	TAH8075
110mm/4"	13 mm	54,99	1	TAH8069C
155mm/6"	20 mm	39,37	1	TAH8070C
205mm/8"	27 mm	40,77	1	TAH8071C
255mm/10"	31 mm	44,70	1	TAH8072C
305mm/12"	34 mm	54,33	1	TAH8073C
380mm/15"	44 mm	90,80	1	TAH8074C
460mm/18"	53 mm	129,88	1	TAH8075C

Llave Podger con anilla de seguridad



TAH84



L	W	€	Box	Key
405mm/16"	41 mm	52,46	1	TAH84-PODGER

Llave combinada con muelle de seguridad



TAH111M



L	W	€	Box	Key
6 mm	112 mm	14,18	1	TAH111M-6
7 mm	120 mm	14,21	1	TAH111M-7
8 mm	130 mm	14,24	1	TAH111M-8
9 mm	136 mm	14,29	1	TAH111M-9
10 mm	144 mm	14,33	1	TAH111M-10
11 mm	153 mm	14,56	1	TAH111M-11
12 mm	160 mm	14,97	1	TAH111M-12
13 mm	165 mm	15,00	1	TAH111M-13
14 mm	177 mm	15,05	1	TAH111M-14
15 mm	185 mm	15,56	1	TAH111M-15
16 mm	195 mm	15,85	1	TAH111M-16
17 mm	200 mm	16,97	1	TAH111M-17
18 mm	208 mm	18,80	1	TAH111M-18
19 mm	215 mm	19,61	1	TAH111M-19
20 mm	240 mm	20,17	1	TAH111M-20
21 mm	250 mm	21,82	1	TAH111M-21
22 mm	250 mm	21,99	1	TAH111M-22
23 mm	270 mm	23,29	1	TAH111M-23
24 mm	270 mm	24,37	1	TAH111M-24
25 mm	290 mm	27,37	1	TAH111M-25
27 mm	310 mm	34,47	1	TAH111M-27
30 mm	330 mm	42,00	1	TAH111M-30
32 mm	345 mm	45,29	1	TAH111M-32
34 mm	347 mm	52,42	1	TAH111M-34
36 mm	400 mm	74,07	1	TAH111M-36
41 mm	438 mm	94,06	1	TAH111M-41
46 mm	500 mm	123,99	1	TAH111M-46
50 mm	540 mm	140,46	1	TAH111M-50
55 mm	560 mm	228,79	1	TAH111M-55

Llave combinada en pulgadas con muelle de seguridad



TAH111Z



L	W	€	Box	Key
1/4 in	112 mm	16,18	1	TAH111Z-1/4
5/16 in	130 mm	16,41	1	TAH111Z-5/16
3/8 in	140 mm	19,16	1	TAH111Z-3/8
7/16 in	153 mm	19,77	1	TAH111Z-7/16

L	W	€	Box	Key
1/2 in	169 mm	20,28	1	TAH111Z-1/2
9/16 in	177 mm	20,87	1	TAH111Z-9/16
5/8 in	195 mm	21,96	1	TAH111Z-5/8
11/16 in	200 mm	21,67	1	TAH111Z-11/16
3/4 in	218 mm	23,20	1	TAH111Z-3/4
13/16 in	250 mm	28,88	1	TAH111Z-13/16
7/8 in	250 mm	30,41	1	TAH111Z-7/8
15/16 in	270 mm	30,95	1	TAH111Z-15/16
1 in	290 mm	33,48	1	TAH111Z-1
1-1/16 in	310 mm	34,82	1	TAH111Z-1.1/16
1-1/8 in	310 mm	38,47	1	TAH111Z-1.1/8
1-1/4 in	350 mm	40,63	1	TAH111Z-1.1/4
1-5/16 in	350 mm	51,56	1	TAH111Z-1.5/16
1 3/8 in	410 mm	72,52	1	TAH111Z-1.3/8
1 7/16 in	410 mm	72,52	1	TAH111Z-1.7/16
1 1/2 in	410 mm	72,51	1	TAH111Z-1.1/2
1 5/8 in	460 mm	99,65	1	TAH111Z-1.5/8
1 11/16 in	460 mm	103,73	1	TAH111Z-1.11/16
1 3/4 in	500 mm	120,49	1	TAH111Z-1.3/4
1 13/16 in	500 mm	123,05	1	TAH111Z-1.13/16
1 7/8 in	540 mm	152,66	1	TAH111Z-1.7/8
2 in	540 mm	153,22	1	TAH111Z-2
2 1/4 in	600 mm	384,85	1	TAH111Z-2.1/4
2 3/8 in	600 mm	384,85	1	TAH111Z-2.3/8
2 5/8 in	680 mm	506,92	1	TAH111Z-2.5/8
2 3/4 in	680 mm	520,88	1	TAH111Z-2.3/4
2 7/8 in	730 mm	683,85	1	TAH111Z-2.7/8
3 in	730 mm	707,62	1	TAH111Z-3

Llave combinada con carraca con muelle de seguridad



TAH1RM



L	W	€	Box	Key
6 mm	128 mm	28,94	1	TAH1RM-6
7 mm	140 mm	28,94	1	TAH1RM-7
8 mm	140 mm	29,07	1	TAH1RM-8
9 mm	150 mm	30,08	1	TAH1RM-9
10 mm	159 mm	30,18	1	TAH1RM-10
11 mm	165 mm	31,84	1	TAH1RM-11
12 mm	172 mm	32,72	1	TAH1RM-12
13 in	178 mm	31,87	1	TAH1RM-13
14 in	191 mm	36,17	1	TAH1RM-14
15 in	200 mm	37,17	1	TAH1RM-15
16 in	208 mm	38,05	1	TAH1RM-16
17 mm	226 mm	38,05	1	TAH1RM-17
18 in	237 mm	39,28	1	TAH1RM-18
19 mm	248 mm	41,04	1	TAH1RM-19
21 in	290 mm	50,80	1	TAH1RM-21
22 in	361 mm	49,16	1	TAH1RM-22
24 mm	323 mm	53,36	1	TAH1RM-24
27 in	359 mm	80,87	1	TAH1RM-27
30 mm	400 mm	95,53	1	TAH1RM-30
32 in	425 mm	106,00	1	TAH1RM-32



Llaves de estrella acodadas, mm con muelle deslizante de acero inoxidable



TAH2M



Diagram	L	€	Icons	Model
6x7 mm	165 mm	50,14	1	TAH2M-6-7
8x9 mm	180 mm	52,17	1	TAH2M-8-9
10x11 mm	190 mm	53,07	1	TAH2M-10-11
12x13 mm	210 mm	53,67	1	TAH2M-12-13
14x15 mm	226 mm	55,05	1	TAH2M-14-15
16x17 mm	246 mm	56,37	1	TAH2M-16-17
18x19 mm	266 mm	58,22	1	TAH2M-18-19

Llave fija, mm., con muelle de seguridad



TAH6M



Diagram	L	€	Icons	Model
6x7 mm	122 mm	13,75	1	TAH6M-6-7
8x9 mm	135 mm	14,35	1	TAH6M-8-9
10x11 mm	153 mm	16,74	1	TAH6M-10-11
12x13 mm	164 mm	17,16	1	TAH6M-12-13
14x15 mm	183 mm	17,41	1	TAH6M-14-15
16x17 mm	201 mm	17,76	1	TAH6M-16-17
17x19 mm	222 mm	20,45	1	TAH6M-17-19
18x19 mm	222 mm	20,55	1	TAH6M-18-19
20x22 mm	225 mm	25,08	1	TAH6M-20-22
24x27 mm	260 mm	43,91	1	TAH6M-24-27
30x32 mm	300 mm	50,90	1	TAH6M-30-32

Llave para racores con muelle de seguridad



TAH1949M



Diagram	L	€	Icons	Model
8x9 mm	140 mm	29,80	1	TAH1949M-8-9
10x11 mm	150 mm	29,80	1	TAH1949M-10-11
12x14 mm	170 mm	33,39	1	TAH1949M-12-14
14x17 mm	200 mm	33,39	1	TAH1949M-14-17
19x22 mm	220 mm	45,66	1	TAH1949M-19-22
24x27 mm	255 mm	66,03	1	TAH1949M-24-27

Llave de impacto boca estrella con argolla



TAH7444SG



Diagram	L	€	Icons	Model
36 mm	205 mm	66,62	1	TAH7444SG-M-36
41 mm	230 mm	85,04	1	TAH7444SG-M-41
46 mm	240 mm	93,23	1	TAH7444SG-M-46
50 mm	255 mm	104,81	1	TAH7444SG-M-50
55 mm	270 mm	119,85	1	TAH7444SG-M-55

Llaves de pipa acodadas 6 x 6-Point Dynamic-Drive™ con anillo de acero inoxidable



TAH29



Diagram	€	Icons	Model
12 mm	80,24	1	TAH29M-12
6 mm	77,12	1	TAH29M-6
7 mm	78,37	1	TAH29M-7
8 mm	79,61	1	TAH29M-8
10 mm	79,61	1	TAH29M-10

Diagram	€	Icons	Model
9 mm	79,61	1	TAH29M-9
11 mm	80,24	1	TAH29M-11
13 mm	80,24	1	TAH29M-13
14 mm	80,24	1	TAH29M-14
15 mm	80,24	1	TAH29M-15
16 mm	80,24	1	TAH29M-16
17 mm	80,85	1	TAH29M-17
18 mm	80,85	1	TAH29M-18
19 mm	80,85	1	TAH29M-19
20 mm	80,85	1	TAH29M-20
21 mm	84,40	1	TAH29M-21
22 mm	84,40	1	TAH29M-22
23 mm	85,03	1	TAH29M-23
24 mm	89,61	1	TAH29M-24
25 mm	90,27	1	TAH29M-25
26 mm	95,17	1	TAH29M-26
27 mm	94,09	1	TAH29M-27
28 mm	97,63	1	TAH29M-28
29 mm	102,17	1	TAH29M-29
30 mm	104,86	1	TAH29M-30
32 mm	109,89	1	TAH29M-32

Llave universal 5 en 1 con cuerda dyneema para trabajos en altura



TAHMK5



Diagram	€	Icons	Model
97x25 mm	44,40	1	TAHMK5

Llave de chicharra equipada con un anillo de seguridad para 13 a 22 tamaños



TAHSC2RM



Diagram	L	€	Icons	Model
13-17 mm	280 mm	54,69	1	TAHSC2RM-13-17
15-17 mm	280 mm	66,69	1	TAHSC2RM-15-17
19-22 mm	310 mm	73,37	1	TAHSC2RM-19-22
27-30 mm	450 mm	120,05	1	TAHSC2RM-27-30

LLAVES PARA TUBOS

Llave de tubo modelo sueco de 90°, con lazo de seguridad



ergo



TAH1410-TAH1420



L	max	€	Icon	Icon	Code
320 mm	1 in	88,03	1	TAH1410	
430 mm	1 1/2 in	97,38	1	TAH1420	

Llave de tubo modelo sueco de 90°, con lazo de seguridad



TAH14

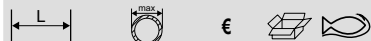

L	max	€	Icon	Icon	Code
210 mm	3/4 in	72,04	1	TAH140	
320 mm	1 in	78,53	1	TAH141	
426 mm	1 1/2 in	102,87	1	TAH142	
557 mm	2-1/2 in	146,74	1	TAH143	

Llave Stillson de aluminio con anilla



TAH380



L	max	€	Icon	Icon	Code
253 mm	1.1/2 in	71,14	1	TAH380-10	
354 mm	2 in	94,57	1	TAH380-14	
455 mm	2.1/2 in	135,06	1	TAH380-18	
607 mm	3 in	200,36	1	TAH380-24	

LLAVES DE VASO Y CARRACAS TRABAJOS EN ALTURA

Vasos hex 1/4" con solución en 4 puntos



TAH08

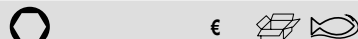

€	Icon	Icon	Code
5.5 mm	6,47	1	TAH08-5.5
6 mm	6,47	1	TAH08-6
7 mm	6,47	1	TAH08-7
8 mm	6,47	1	TAH08-8
9 mm	6,47	1	TAH08-9
10 mm	6,47	1	TAH08-10
11 mm	6,47	1	TAH08-11
12 mm	6,47	1	TAH08-12
13 mm	6,47	1	TAH08-13

Mango articulado 1/4" con muelle se seguridad



TAH6958B-1



L	€	Icon	Icon	Code
150 mm	44,30	1	TAH6958B-1	

Alargadera 1/4" con solución en 4 puntos



TAH6960-TAH6962L

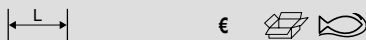

L	€	Icon	Icon	Code
50 mm	11,90	1	TAH6960	
101 mm	12,91	1	TAH6961	
152 mm	16,50	1	TAH6962	
355 mm	37,64	1	TAH6962L	

Articulación universal 1/4" con solución en 4 puntos



TAH6966

L	€	Icon	Icon	Code
36 mm	29,80	1	TAH6966	

Vasos 1/4" punta hexagonal con solución en 4 puntos



TAH08-H



€	Icon	Icon	Code
3 mm	8,50	1	TAH08-H3
4 mm	8,50	1	TAH08-H4
5 mm	8,50	1	TAH08-H5
6 mm	8,50	1	TAH08-H6
8 mm	8,50	1	TAH08-H8

Vasos 1/4" para punta PH con solución en 4 puntos



TAH08-PH

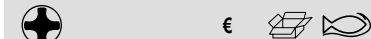

€	Icon	Icon	Code
1	9,40	1	TAH08-PH1
2	9,40	1	TAH08-PH2
3	9,40	1	TAH08-PH3



Vasos 1/4" para punta TORX® con solución en 4 puntos



TAH08TTAH



	€		
T-8	10,58	1	TAH08-T8
T-9	10,58	1	TAH08-T9
T-10	10,58	1	TAH08-T10
T-15	10,58	1	TAH08-T15
T-20	10,58	1	TAH08-T20
T-25	10,93	1	TAH08-T25
T-27	10,93	1	TAH08-T27
T-30	10,93	1	TAH08-T30
T-40	10,93	1	TAH08-T40

Carraca 1/4, 72 dientes/5° ángulo de acción, con cuerda Dyneema



TAH6950



L	€		
120 mm	51,20	1	TAH6950

Portavasos 1/4" con cuello de seguridad



TAH6956-1



L	€		
150 mm	15,15	1	TAH6956-1

Vasos bihex. 1/2" con solución en 4 puntos



TAH16B



	€		
8 mm	8,89	1	TAH16B-8
10 mm	8,21	1	TAH16B-10
11 mm	8,21	1	TAH16B-11
12 mm	8,70	1	TAH16B-12
13 mm	9,08	1	TAH16B-13
14 mm	9,53	1	TAH16B-14
15 mm	9,90	1	TAH16B-15
16 mm	10,09	1	TAH16B-16
17 mm	10,48	1	TAH16B-17
18 mm	10,48	1	TAH16B-18
19 mm	10,91	1	TAH16B-19
21 mm	11,50	1	TAH16B-21
22 mm	11,91	1	TAH16B-22
24 mm	13,43	1	TAH16B-24
25 mm	13,63	1	TAH16B-25
27 mm	14,32	1	TAH16B-27
30 mm	15,93	1	TAH16B-30
32 mm	16,25	1	TAH16B-32

Vaso bihex. 1/2" con solución en cuatro puntos



TAH16B"



	€		
1/2 in	9,32	1	TAH16B-1/2
9/16 in	9,93	1	TAH16B-9/16
5/8 in	10,48	1	TAH16B-5/8
11/16 in	10,79	1	TAH16B-11/16
3/4 in	11,30	1	TAH16B-3/4
13/16 in	11,91	1	TAH16B-13/16
7/8 in	12,32	1	TAH16B-7/8
15/16 in	13,91	1	TAH16B-15/16
1 in	13,91	1	TAH16B-1
1 1/16 in	16,75	1	TAH16B-1.1/16
1 1/8 in	16,75	1	TAH16B-1.1/8
1 1/4 in	16,76	1	TAH16B-1.1/4

Mango articulado 1/2" con muelle de seguridad



TAH8158B-1



L	€		
256 mm	106,88	1	TAH8158B-1

Alargadera 1/2" con solución en cuatro puntos



TAH8160-8162

L	€		
125 mm	81,85	1	TAH8160
250 mm	100,54	1	TAH8162

Junta universal 1/2" con solución en cuatro puntos



TAH8166

L	€		
67 mm	41,56	1	TAH8166

Vaso con punta 1/2" hex. con solución en cuatro puntos



TAH16H

	€		
4 mm	16,37	1	TAH16-H4
5 mm	16,37	1	TAH16-H5
6 mm	16,37	1	TAH16-H6
7 mm	16,37	1	TAH16-H7
8 mm	17,73	1	TAH16-H8
10 mm	17,73	1	TAH16-H10
12 mm	18,15	1	TAH16-H12
14 mm	19,90	1	TAH16-H14
17 mm	19,08	1	TAH16-H17
19 mm	19,61	1	TAH16-H19

Vasos con punta 1/2" hex. con solución en cuatro puntos



TAH16H"

	€		
1/4 in	16,06	1	TAH16H-1/4
5/16 in	16,06	1	TAH16H-5/16
3/8 in	16,06	1	TAH16H-3/8
7/16 in	16,53	1	TAH16H-7/16
1/2 in	17,46	1	TAH16H-1/2
9/16 in	17,89	1	TAH16H-9/16
5/8 in	18,36	1	TAH16H-5/8

Vasos con punta 1/2" TORX® con solución en cuatro puntos



TAH16-T

	€		
T30	18,56	1	TAH16-T30
T40	21,67	1	TAH16-T40
T45	21,67	1	TAH16-T45

	€		
T50	21,67	1	TAH16-T50
T55	27,13	1	TAH16-T55
T60	27,13	1	TAH16-T60

Carraca reversible 1/2" - 80 dientes/ 4.5° ángulo de acción, con cuerda Dyneema



TAH8150-1/2

	€		
270 mm	81,82	1	TAH8150-1/2

Juego de vasos 1/2" con carraca tipo pera - 22 piezas



TAH16BM/22

	€		
85 x 350 x 445 mm	499,12	1	TAH16BM/22

Juego de vasos 1/2" con carraca tipo pera - 17 piezas



TAH16BZ/17

	€		
80 x 300 x 380 mm	429,80	1	TAH16BZ/17

Vasos bihex. 3/4" con solución de 4 puntos



TAH24B

	€		
27 mm	25,19	1	TAH24B-27
30 mm	28,27	1	TAH24B-30
32 mm	29,44	1	TAH24B-32
36 mm	34,03	1	TAH24B-36
38 mm	36,24	1	TAH24B-38
41 mm	39,93	1	TAH24B-41
46 mm	47,12	1	TAH24B-46
50 mm	53,24	1	TAH24B-50

Alargaderas 3/4" con 4 puntos



TAH8961

	€		
200 mm	49,21	1	TAH8961

Mango universal 3/4" con cuerda de alambre



TAH8953

	€		
500 mm	56,08	1	TAH8953



Cabeza de carraca reversible 3/4", con cuerda de alambre



TAH8950N/A

	€		
170 mm	203,81	1	TAH8950N/A

Liberador de pin para vasos TAH



ergo



TAHPINRELEASER

		€		
4 mm	45 mm	47,98	1	TAHPINRELEASER

DESTORNILLADORES

Destornillador ERGO™ boca recta con placa de inserción



ergo



TAHBE8020L-TAHBE8252

		€		
3.2 mm	75 mm	19,26	1	TAHBE-8020L
3.5 mm	75 mm	19,79	1	TAHBE-8030
4 mm	100 mm	20,68	1	TAHBE-8040
5.5 mm	150 mm	24,19	1	TAHBE-8241
6.5 mm	150 mm	28,34	1	TAHBE-8252

Destornillador ERGO™ boca plana con cuerda Dyneema



ergo



TAHBE8155

		€		
6 mm	125 mm	29,96	1	TAHBE-8155
8 mm	175 mm	35,14	1	TAHBE-8257
10 mm	210 mm	37,50	1	TAHBE-8258

Destornillador ERGO™ boca plana con cuerda Dyneema



ergo



TAHBE-8260

		€		
9 mm	175 mm	40,78	1	TAHBE-8260
12 mm	200 mm	53,59	1	TAHBE-8880

Destornillador stubby ERGO™ boca recta con cuello de seguridad



ergo



TAHBE-8350

		€		
5.5 mm	28 mm	21,71	1	TAHBE-8350

Destornilladores ERGO™ PH con cuello de seguridad



ergo



TAHBE8610-TAHBE8624

		€		
PH 1	75 mm	23,84	1	TAHBE-8611
PH 1	75 mm	23,71	1	TAHBE-8610
PH 2	100 mm	27,56	1	TAHBE-8620
PH 2	200 mm	31,04	1	TAHBE-8620L
PH 3	150 mm	35,00	1	TAHBE-8623
PH 4	190 mm	39,99	1	TAHBE-8624

Destornilladores ERGO™ PH con cuerda Dyneema



ergo



TAHBE-8630

		€		
PH 3	155 mm	42,62	1	TAHBE-8630

Destornilladores stubby ERGO™ PH con cuello de seguridad



ergo



TAHBE-8602

		€		
PH2	30 mm	24,02	1	TAHBE-8602

Destornilladores ERGO™ PZ con cuello de seguridad



ergo



TAHBE8810-TAHBE8820



			€		
PZ 1		73 mm	25,29	1	TAHBE-8810
PZ 2		100 mm	29,00	1	TAHBE-8820

Destornilladores aislado ERGO™ boca plana con cuerda Kevlar



ergo



TAHBE8040S-TAHBE8050S

			€		
3.0 mm		100 mm	10,85	1	TAHBE-8220S
4.0 mm		100 mm	13,16	1	TAHBE-8040S
5.5 mm		125 mm	15,70	1	TAHBE-8050S
6.5 mm		155 mm	20,08	1	TAHBE-8255S

Destornilladores Pozidriv aislados VDE y delgados ERGO™ con mango de tres componentes, con muelle Kevlar



ergo



TAHBE-8820SL

			€		
PZ 2		PZ 2	21,69	1	TAHBE-8820SL

Destornilladores ERGO™ PZ varilla hexagonal con cuerda Dyneema



ergo



TAHBE-8830



			€		
PZ 3		150 mm	42,62	1	TAHBE-8830

Destornilladores aislados ERGO™ PH con cuerda Kevlar



ergo



TAHBE8610S-TAHBE8620S

			€		
PH1		80 mm	13,96	1	TAHBE-8610S
PH2		100 mm	18,02	1	TAHBE-8620S
PH3		150 mm	23,09	1	TAHBE-8630S
PH4		190 mm	34,18	1	TAHBE-8640S

Destornilladores planos de precisión con anilla de acero inoxidable



TAH700

			€		
1.5 mm		137 mm	54,44	1	TAH700-1.5-50
1.8 mm		137 mm	54,44	1	TAH700-1.8-50
2.5 mm		137 mm	54,92	1	TAH700-2.5-50
3 mm		187 mm	54,92	1	TAH700-3-100

Destornillador ERGO™ para tornillos TORX® con placa de inserción



ergo



TAHBE8910-TAHBE8930



			€		
T10		2.72 mm	27,11	1	TAHBE-8910
T15		3.26 mm	28,01	1	TAHBE-8915S
T20		3.84 mm	29,34	1	TAHBE-8920
T25		4 mm	30,68	1	TAHBE-8925S
T30		6 mm	32,02	1	TAHBE-8930

Destornillador ERGO™ aislado para tornillos TORX®



ergo



TAHBE8910S-TAHBE8930S

			€		
T10		2.5 mm	20,01	1	TAHBE-8910S
T15		3.26 mm	25,34	1	TAHBE-8915S
T20		3.84 mm	30,02	1	TAHBE-8920S
T25		4.4 mm	32,02	1	TAHBE-8925S
T30		5.49 mm	33,35	1	TAHBE-8930S

Destornilladores Phillips de precisión con anilla de acero inoxidable



TAH701

			€		
PH00		137 mm	54,49	1	TAH701-00-50
PH 0		137 mm	54,49	1	TAH701-0-50



Destornilladores TORX® de precisión con anilla de acero inoxidable



TAH703

Icon	Length	Price (€)	Box	Weight	Code
T 6	137 mm	54,63	1		TAH703-6-50
T 7	137 mm	54,63	1		TAH703-7-50
T 8	137 mm	54,63	1		TAH703-8-50
T 9	137 mm	54,68	1		TAH703-9-50
T 10	137 mm	54,60	1		TAH703-10-50
T 15	162 mm	54,81	1		TAH703-15-75

Llaves tipo "allen" fosfatadas métricas con anilla de acero inoxidable, 7 piezas



TAHBE-9776

Icon	Hex Size	Price (€)	Box	Weight	Code
X	7 1.5 2.5 3 4 5 6 mm	48,43	1		TAHBE-9776

Llave acodada doble con alambre de acero



TAH2047

Icon	Width	Length	Price (€)	Box	Weight	Code
	4.0 mm	100 mm	27,97	1		TAH2047-0.8-4

Llaves tipo "allen" fosfatadas métricas con anilla de acero inoxidable



TAH1995M

Icon	Length	Price (€)	Box	Weight	Code
8 mm	108 mm	24,28	1		TAH1995M-8
10 mm	122 mm	25,07	1		TAH1995M-10
12 mm	137 mm	26,33	1		TAH1995M-12

Juego 7 llaves allen hex., métricas, en cuerda Kevlar



TAHBE-9777B

Icon	Hex Size	Price (€)	Box	Weight	Code
	2.5,3,4,5,6,8,10 mm	39,76	1		TAHBE-9777B

Llaves tipo "allen" fosfatadas métricas con anilla de acero inoxidable



TAH1995Z

Icon	Length	Price (€)	Box	Weight	Code
1/2 in	145 mm	27,97	1		TAH1995Z-1/2

Juego 7 llaves allen hex., pulgadas, con placa de inserción



TAHBE-9787

Icon	Hex Size	Price (€)	Box	Weight	Code
	3/32, 1/8, 5/32, 3/16, 1/4, 5/16, 3/8 in	42,57	1		TAHBE-9787

Llave acodada para tornillos PH con alambre de acero



TAH2047PR

Icon	Length	Price (€)	Box	Weight	Code
PH 1 & 2	100 mm	31,48	1		TAH2047PR-1-2

ALICATES

Alicate diagonal con anilla de seguridad



ergo®



TAH2101G

Icon	Length	Price (€)	Box	Weight	Code
130 mm		57,36	1		TAH2101G-125
145 mm		52,70	1		TAH2101G-140
165 mm		61,06	1		TAH2101G-160
185 mm		62,69	1		TAH2101G-180
125 mm		57,36	1		TAH2101G-125C
145 mm		60,30	1		TAH2101G-140C
165 mm		61,06	1		TAH2101G-160C
180 mm		62,69	1		TAH2101G-180C

Alicate cortante "Heavy Duty" con anilla de seguridad



ergo



TAH21HDG



L	€	Icon	Icon
210 mm	64,02	1	TAH21HDG-200
200 mm	64,02	1	TAH21HDG-200C

Alicate boca semirredonda plana con anilla de seguridad



ergo



TAH2430G



L	€	Icon	Icon
160 mm	43,10	1	TAH2430G-160
200 mm	43,61	1	TAH2430G-200

Alicates de carraca para terminales aislados con lazo de alambre metálico fijo



TAHCRW01

L	Icon	€	Icon	Icon
225 mm	0.5-6.0 mm ²	151,03	1	TAHCRW01

Alicates universales con anilla de seguridad



ergo



TAH2628G



L	€	Icon	Icon
170 mm	56,75	1	TAH2628G-160
190 mm	58,49	1	TAH2628G-180
200 mm	74,65	1	TAH2628G-200

Alicate boca semirredonda curvado con anilla de seguridad



ergo



TAH2427G



L	€	Icon	Icon
200 mm	44,77	1	TAH2427G-200

Alicates para arandelas interiores con mordazas rectas y anilla de acero inoxidable



TAH2800



L	€	Icon	Icon
150 mm	44,81	1	TAH2800-150
180 mm	75,54	1	TAH2800-180

Alicate de apertura múltiple con anillo de seguridad



TAH2970G



L	€	Icon	Icon
200 mm	59,47	1	TAH2970G-200

Alicate pelacables para trabajos en altura



ergo



TAH2223G-150



L	€	Icon	Icon
167 mm	56,58	1	TAH2223G-150

Alicates para arandelas exteriores con mordazas rectas y anilla de acero inoxidable



TAH2900



L	€	Icon	Icon
180 mm	76,17	1	TAH2900-180



Grip universal mordazas curvadas para trabajos en altura



TAH2951



	€		
235 m	62,05	1	TAH2951-250

Mordazas grip autoajustables con bocas curvas y placa metálica fijada



TAH2953



	€		
140 mm	57,40	1	TAH2953-140
300 mm	73,02	1	TAH2953-300

Mordaza grip boca recta con placa de inserción



TAH2958



	€		
200 mm	45,94	1	TAH2958-200
245 mm	49,64	1	TAH2958-250

Tenacilla articulada ERGO™ con anilla de seguridad



ergo



TAH8224



	€		
250 mm	73,52	1	TAH8224

Tenaza de encofrador con gran efecto palanca y Anillo de Seguridad



TAH2339



		€		
2.5 mm	250 mm	39,66	1	TAH2339-250

Alicate trenzador con anilla de seguridad



TAH2855



	€		
232 mm	205,05	1	TAH2855

HERRAMIENTAS DE CORTE

Serruchos de poda plegables con mango bi-componente y muelle sellado Dyneema



TAH396



		€		
190 mm	7 1/2 in	58,37	1	TAH396-JT

Arco de sierra con cable de alambre



ergo



TAH325



	€		
300 mm	73,07	1	TAH325

Arco de sierra tradicional con cable de alambre



TAH320



	€		
500 mm	28,80	1	TAH320

Arco de sierra con cable de alambre



TAH317

	€		
432 mm	39,28	1	TAH317

Arco de sierra de aluminio con cable de alambre



TAH225

	€		
310 mm	53,76	1	TAH225-PLUS

Lima plana con anilla de seguridad



TAH1-100

		€		
265 mm	2	19,95	1	TAH1-100-06-2-4

Limas planas Ergo™ con anilla de acero inoxidable



TAH1-110

		€		
200 mm	1	22,08	1	TAH1-110-08-1-2

Lima basta 2 cantos planos y anilla de seguridad



TAH1-143

		€		
415 mm	1	25,53	1	TAH1-143-12-1-2

Limas cuadradas Ergo™ con anilla de acero inoxidable



TAH1-160

		€		
200 mm	1	19,80	1	TAH1-160-08-1-2

Limas triangulares Ergo™ con anilla de acero inoxidable



TAH1-170

		€		
200 mm	1	20,66	1	TAH1-170-08-1-2

Lima media caña con anilla de seguridad



TAH1-210

		€		
270 mm	2	23,01	1	TAH1-210-06-2-2
325 mm	1	24,41	1	TAH1-210-08-1-2

Lima redonda con myril de seguridad



TAH1-230

		€		
260 mm	2	12,57	1	TAH1-230-06-2-2
310 mm	1	25,84	1	TAH1-230-08-1-2

Tijera de electricista con asa de alambre



TAHSCB140G

		€		
145 mm	43 mm	41,68	1	TAHSCB140G

Navaja de electricista con cadena de Dyneema



TAH2820EF

		€		
195 mm	85 mm	27,56	1	TAH2820EF2



Cepillo de uso general



TAH52-TAH782-U



L	€	Icon	Icon
150 mm	24,68	1	TAH52
290 mm	23,61	1	TAH782-U

Martillo de bola con cable de acero



TAH479



L	€	Icon	Icon
480 g	350 mm	62,93	1 TAH479-16
900 g	400 mm	68,89	1 TAH479-32

Maza de seguridad con anilla



TAH489



L	€	Icon	Icon
1100 g	294 mm	204,94	1 TAH489-1100
1800 g	300 mm	219,51	1 TAH489-1800
2700 g	770 mm	228,59	1 TAH489-2700
3600 g	770 mm	252,12	1 TAH489-3600
4500 g	797 mm	352,14	1 TAH489-4500
5400 g	795 mm	297,56	1 TAH489-5400

MARTILLOS, PALANCAS Y CINCELES

Martillo anti-rebote con anilla de seguridad



TAH3625PU



L	€	Icon	Icon
620 g	340 mm	62,53	1 TAH3625PU-50

Martillo tipo alemán DIN con cable de acero



TAH481



L	€	Icon	Icon
300 g	300 mm	49,86	1 TAH481-300

Martillos de bola con mango irrompible y lazo de alambre metálico fijo



TAH490



L	€	Icon	Icon
700 g	340 mm	131,77	1 TAH490-700
900 g	340 mm	137,92	1 TAH490-900
1100 g	340 mm	162,21	1 TAH490-1100

Maza boca de nylon con cable de acero



TAH3625PW



L	€	Icon	Icon
300 mm	52,89	1	TAH3625W-35

Maceta con cable de acero



TAH484



L	€	Icon	Icon
1000 g	260 mm	62,24	1 TAH484-1000
1500 g	280 mm	60,26	1 TAH484-1500
2000 g	305 mm	63,20	1 TAH484-2000

Piqueta con anilla de alambre



TAH486F



L	€	Icon	Icon
700 g	330 mm	31,89	1 TAH486F-700

Martillo de carpintero con varilla de acero tubular y alambre de acero



TAH485



		€		
600 g	318 mm	60,67	1	TAH485

Botador cilíndrico bi-material con placa de inserción



TAH3734BM



		€		
155 mm	2 mm	29,95	1	TAH3734BM-2
155 mm	3 mm	29,95	1	TAH3734BM-3
165 mm	4 mm	30,41	1	TAH3734BM-4
165 mm	5 mm	30,41	1	TAH3734BM-5
185 mm	6 mm	31,26	1	TAH3734BM-6
185 mm	8 mm	31,48	1	TAH3734BM-8
185 mm	10 mm	23,37	1	TAH3734BM-10

Cinzel octogonal con lazo de alambre metálico fijo



TAH3739



	€		
300 mm	34,15	1	TAH3739-300

Martillo anti chispa y anti magnético con argolla de aluminio bronce



TAH487



		€		
4500 g	895 mm	594,59	1	TAH487-5200

Granete bi-material con placa de inserción



TAH3755BM



		€		
165 mm	4 mm	16,54	1	TAH3755BM-4

Palanca polivalente con anilla de seguridad



TAH2484



	€		
305 mm	15,42	1	TAH2484-30

Barra desencofradora para trabajos en altura



TAHWBB



	€		
595 mm	39,14	1	TAHWBB600
680 mm	41,68	1	TAHWBB700

Cortafrios plano con anilla de seguridad



TAH3640



	€		
250 mm	33,89	1	TAH3640-250-C

Palanca especial 90° con argolla



TAH3683



	€		
400 mm	43,43	1	TAH3683



Palancas con cuerpo fosfatado y lazo de alambre metálico fijo



TAH3681



← L →	€		
304 mm	71,49	1	TAH3681-11
406 mm	79,03	1	TAH3681-16
503 mm	97,15	1	TAH3681-20

Nivel yamio con cuerda



TAH466



← L →	€		
250 mm	44,42	1	TAH466-250

Escuadra equipada con dyneema para Trabajos en Altura



TAH9045-B-250



← L →	← L →	€		
250 mm	170 mm	37,07	1	TAH9045-B-250

MEDICIÓN Y TRAZADO

Cintas métricas con hoja revestida de nylon y carcasa abierta y con lazo de alambre de Dyneema



TAHLTS

← L →	← L →	€		
30 m	13 mm	81,60	1	TAHLTS-30

Escuadra combinada equipado con dyneema para Trabajar en Altura



TAHCS300

← L →	← L →	€		
300 mm	125 mm	37,07	1	TAHCS300

Calibre con anilla de seguridad



TAH1150



← L →	€		
7 x 75 x 235 mm	131,37	1	TAH1150-1/2H/P

Reglas métricas de acero inoxidable con lazo de alambre de Dyneema



TAHSR300



← L →	€		
300 mm	51,17	1	TAHSR300-MM

Escuadra equipada con dyneema para Trabajos en Altura



TAH9048-250



← L →	← L →	€		
250 mm	165 mm	38,23	1	TAH9048-250

Punta de trazar con cuerda de alambre



TAH1177



g	€		
30 g	24,29	1	TAH1177-SCRIBE

Galgas profesionales con anillo de seguridad



TAH1544



	€		
105 mm	20,55	1	TAH1544

HERRAMIENTAS DINAMOMÉTRICAS

Llave dinamométrica de disparo mecánico ajustable con visor de escala y cabeza fija de carraca con placa metálica



TAH73R



	€		
1/2"	20-100 N·m	442,36	1 TAH73R-100
1/2"	40-200 N·m	457,11	1 TAH73R-200
1/2"	60-300 N·m	473,96	1 TAH73R-300

Llave dinamométrica reversible mango de metal con escala con anillo de alambre



TAH7445



	€		
20-100 N·m	1/2 in	326,82	1 TAH7445-100A-1

Llave dinamométrica con anillo de alambre



TAH7455



	€		
60-300 N·m 44.3-221.3 lbf·ft	397,31	1	TAH7455-300-1

Llave dinamométrica con cabeza intercambiable y alambre de seguridad



TAH74W9



	€		
20-100 N·m 9x12 mm	260,51	1	TAH74W9-100

Cabeza de carraca reversible con dispositivo de bloqueo



TAH7452-2



	€		
9x12 mm	1/2"	120,65	1 TAH7452-2

Cabeza intercambiable carraca reversible con mecanismo de cierre pin de seguridad



TAH7852-1



	€		
14X18 mm	1/2"	96,31	1 TAH7852-1

HERRAMIENTAS DE SUJECCIÓN

Mordaza mango de plástico con grillete de seguridad para Trabajos en Altura



TAH420SH-80-160



	€		
160 mm	80 mm	44,82	1 TAH420SH-80-160

OTRAS HERRAMIENTAS

Rasqueta de carbono con muelle de seguridad



TAH2487



	€		
205 mm	21,45	1	TAH2487



Juego de punzones y ganchos con alambre Kevlar, 4 piezas



TAH2633



g	€		
146 g	122,64	1	TAH2633/S4

Llave de filtro de cadena



TAHBE64520



		€		
520 mm	60-160 mm	96,33	1	TAHBE64520

GUANTES

Guantes de trabajo multiusos



GL008

	€		
8	19,67	5	GL008-8
10	19,67	5	GL008-10

Dedo flexible con cuerda de alambre



TAH2509



	€		
560 mm	94,11	1	TAH2509

Lámpara frontal con cuerda



TAHBFRL11



	€		
90 x 95 x 115 mm	77,61	1	TAHBFRL11

Guantes multi-usos



3875-GLOVE

	g	€		
9	67 g	15,87	5	3875-GLOVE

Extractor magnético con cuerda



ergo®



TAH2535F2



		€		
13 mm	405 mm	51,18	1	TAH2535F2

Bomba de grasa de acoplamiento rápido



TAHBOD54

	€		
120 x 385 x 57 mm	51,41	1	TAHBOD5400
135 x 400 x 61 mm	70,94	1	TAHBOD5450

Guantes para herramienta de impacto



GL010

	€		
8	24,98	5	GL010-8
10	24,98	5	GL010-10



Herramientas aisladas



DESTORNILLADORES AISLADOS

Destornillador ERGO™ aislado punta plana



ergo



BE-8010S - BE-8065S

Tip	Length	Price	Quantity	Model
2.5 mm	75 mm	7,65	5	BE-8010S
3.0 mm	100 mm	7,65	5	BE-8220S
3.5 mm	100 mm	7,98	5	BE-8230S
4.0 mm	100 mm	9,28	5	BE-8040S
5.5 mm	125 mm	11,08	5	BE-8050S
6.5 mm	150 mm	14,17	5	BE-8255S
8.0 mm	175 mm	15,65	5	BE-8065S
10 mm	200 mm	20,46	5	BE-8258S
12 mm	200 mm	23,78	5	BE-8259S

Destornillador aislado ERGO™ punta Phillips



ergo



BE-8600S - BE-8640S

Tip	Length	Price	Quantity	Model
PH 0	75 mm	7,97	5	BE-8600S
PH 1	80 mm	9,86	5	BE-8610S
PH1	80 mm	9,84	5	BE-8611S
PH 1	150 mm	11,24	5	BE-8612S
PH 2	100 mm	12,70	5	BE-8620S
PH 2	100 mm	15,41	5	BE-8621S
PH 2	175 mm	15,45	5	BE-8622S
PH 3	150 mm	16,29	5	BE-8630S
PH 4	200 mm	24,11	5	BE-8640S

Destornilladores ERGO™ aislados punta Pozidriv



ergo



BE-8800S - BE-8840S

Tip	Length	Price	Quantity	Model
PZ 0	75 mm	8,85	5	BE-8800S
PZ 1	80 mm	10,58	5	BE-8810S
PZ1	80 mm	10,58	5	BE-8811S
PZ 1	150 mm	12,53	5	BE-8812S
PZ 2	100 mm	13,20	5	BE-8820S
PZ 2	100 mm	13,69	5	BE-8821S
PZ 2	175 mm	15,50	5	BE-8822S
PZ 3	150 mm	19,87	5	BE-8830S
PZ 4	200 mm	22,81	5	BE-8840S

Destornillador ERGO™ aislado para tornillos TORX®



ergo



BE-8910S - BE-8930S

Tip	Length	Price	Quantity	Model
T 5	75 mm	8,00	5	BE-8905S
T 6	75 mm	8,00	5	BE-8906S
T 7	75 mm	8,00	5	BE-8907S
T 8	75 mm	8,00	5	BE-8908S
T 9	75 mm	8,00	5	BE-8909S
T 10	100 mm	8,26	5	BE-8910S
T 15	125 mm	8,32	5	BE-8915S
T 20	125 mm	8,47	5	BE-8920S
T 25	150 mm	8,78	5	BE-8925S
T 30	175 mm	11,34	5	BE-8930S

Destornillador ERGO™ aislado hexagonal



ergo



BE-8725S - BE-8708S

Tip	Length	Price	Quantity	Model
2.5 mm	100 mm	6,30	5	BE-8725S
3 mm	125 mm	6,57	5	BE-8703S
4 mm	150 mm	7,99	5	BE-8704S
5 mm	175 mm	9,04	5	BE-8705S
6 mm	150 mm	9,51	5	BE-8706S
8 mm	200 mm	12,80	5	BE-8708S

Destornilladore ERGO™ aislados puntas combi



ergo



BE-8510S - BE-8520S

Tip	Length	Price	Quantity	Model
5.0/PH1	80 mm	9,80	5	BE-8510S
6.0/PH2	100 mm	13,35	5	BE-8520S

Destornilladores ERGO™ aislados puntas combi



ergo



BE-8710S - BE-8720S

Tip	Length	Price	Quantity	Model
5.0/PZ1	80 mm	10,67	5	BE-8710S
6.0/PZ2	100 mm	14,43	5	BE-8720S

Destornillador stecker aislado ERGO™



ergo



BE-7855S - BE-7810S

Tip	Length	Price	Quantity	Model
5.5 mm	125 mm	14,54	5	BE-7855S
6 mm	125 mm	15,97	5	BE-7806S
7 mm	125 mm	17,12	5	BE-7807S
8 mm	125 mm	18,90	5	BE-7808S
9 mm	125 mm	21,02	5	BE-7809S
10 mm	125 mm	23,25	5	BE-7810S

Juego 2 destornilladores ERGO™ aislados



ergo



BE-9890S

2 175 g 24,13 € 1 BE-9890S

Uso en cuadros eléctricos y terminales

BE-8710S, BE-8720S

Juego 5 destornilladores ERGO™ aislados



ergo



BE-9881S

5 44,18 € 1 BE-9881S

BE-8220S, BE-8040S, BE-8050S

BE-8611S, BE-8621S

Juego 5 destornilladores ERGO™ aislados



ergo



BE-9882S

5 45,58 € 1 BE-9882S

BE-8220S, BE-8050S, BE-8040S

BE-8811S, BE-8821S

Juego 4 destornilladores ERGO™ aislados



ergo



BE-9885S

5 47,06 € 1 BE-9885S

806-1-1

BE-8520S, BE-8510S

BE-8710S, BE-8720S

Juego 6 destornilladores ERGO™ aislados



ergo



BE-9884S

6 64,77 € 1 BE-9884S

BE-8220S, BE-8040S

BE-8710S, BE-8720S

BE-8810S, BE-8820S

Juego 7 destornilladores ERGO™ aislados



ergo



BE-9888S

7 65,00 € 1 BE-9888S

BE-8040S, BE-8050S, BE-8010S, BE-8220S

BE-8800S, BE-8821S, BE-8830S

Juego 6 destornilladores ERGO™ aislados y comprobador de tensión



ergo



BE-9887S

7 60,22 € 1 BE-9887S

806-1-1

BE-8010S, BE-8050S, BE-8230S, BE-8040S

BE-8611S, BE-8621S

Juego 6 destornilladores ERGO™ aislados y comprobador de tensión



ergo



BE-9889S

7 55,37 € 1 BE-9889S

BE-8010S, BE-8040S, BE-8050S, BE-8230S

BE-8821S, BE-8811S

806-1-1



Juego destornilladores ERGO™ aislados, 14 piezas



ergo



BE-9876S

	€		
14	113,74	1	BE-9876S

BE-8010S, BE-8220S, BE-8230S, BE-8040S, BE-8050S		
BE-8611S, BE-8621S		
BE-8811S, BE-8821S		
BE-8910S, BE-8915S, BE-8920S		
BE-8710S, BE-8720S		

Destornilladores ERGO™ aislados con aislamiento integrado



ergo



BE-8220SL - BE-8255SL

		€		
3.0 mm	100 mm	8,43	10	BE-8220SL
3.5 mm	100 mm	8,78	10	BE-8230SL
4.0 mm	100 mm	10,21	10	BE-8040SL
5.5 mm	125 mm	12,19	10	BE-8050SL
6.5 mm	150 mm	15,60	10	BE-8255SL

Destornilladores ERGO™ aislados PH con aislamiento integrado



ergo



BE-8610SL - BE-8620SL

		€		
PH 1	80 mm	10,84	10	BE-8610SL
PH 2	100 mm	13,99	10	BE-8620SL

Destornilladores ERGO™ aislados PZ con aislamiento integrado



ergo



BE-8810SL - BE-8820SL

		€		
PZ 1	80 mm	11,65	10	BE-8810SL
PZ 2	100 mm	14,51	10	BE-8820SL

Destornilladores ERGO™ aislados TORX con aislamiento integrado



ergo



BE-8910SL - BE-8930SL

		€		
T 10	100 mm	9,08	5	BE-8910SL
T 15	100 mm	9,16	5	BE-8915SL
T 20	100 mm	9,32	5	BE-8920SL
T 25	125 mm	9,66	5	BE-8925SL
T 30	150 mm	12,49	5	BE-8930SL

Destornilladores ERGO™ aislados punta COMBI PL/ PH con aislamiento integrado



ergo



BE-8510SL - BE-8520SL

		€		
5.0/PH1	80 mm	10,78	10	BE-8510SL
6.0/PH2	100 mm	14,69	10	BE-8520SL

Destornilladores ERGO™ aislados punta COMBI PL/PZ con aislamiento integrado



ergo



BE-8710SL - BE-8720SL

		€		
5.0/PZ1	80 mm	11,74	10	BE-8710SL
6.0/PZ2	100 mm	15,88	10	BE-8720SL

Juego 2 destornilladores ERGO™ aislados varilla integrada



ergo



BE-9890SL

		€		
2	175 g	26,56	1	BE-9890SL

BE-8710SL, BE-8720SL

Juego 2 destornilladores ERGO™ aislados varilla integrada



ergo



BE-9891SL

		€		
2	132 g	23,87	1	BE-9891SL

BE-8610SL, BE-8620SL

Juego 2 destornilladores ERGO™ aislados varilla integrada



BE-9894SL

X	g	€		
2	132 g	25,16	1	BE-9894SL

BE-8810SL, BE-8820SL



Juego 4 destornilladores ERGO™ aislados con varilla integrada



BE-9880SL

X	€			
4	42,85	1	BE-9880SL	

BE-8910SL, BE-8915SL, BE-8920SL, BE-8925SL

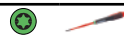

Juego 5 destornilladores ERGO™ aislados con varilla integrada



BE-9881SL

X	€			
5	48,59	1	BE-9881SL	

BE-8220SL, BE-8040SL, BE-8050SL



BE-8610SL, BE-8620SL



Juego 5 destornilladores ERGO™ aislados con varilla integrada

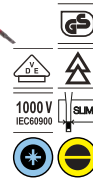

BE-9882SL

X	€			
5	50,14	1	BE-9882SL	

BE-8220SL, BE-8040SL, BE-8050SL

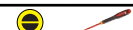

BE-8810SL, BE-8820SL



Juego 5 destornilladores varilla fina

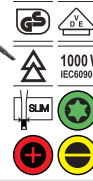

BE-9871SL

X	€			
5	53,62	1	BE-9871SL	

BE-8220SL, BE-8040SL



BE-8910SL



BE-8610SL, BE-8620SL



Juego 5 destornilladores varilla fina



BE-9872SL

X	€			
5	54,77	1	BE-9872SL	

BE-8220SL, BE-8040SL

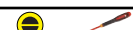

BE-8910SL

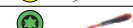

BE-8810SL, BE-8820SL

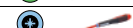

Juego 12 destornilladores ERGO™ aislados



BE-9878SL

X	€			
12	107,89	1	BE-9878SL	

BE-8010S



BE-8220SL, BE-8230SL, BE-8040SL, BE-8050SL



BE-8610SL, BE-8620SL



BE-8810SL, BE-8820SL



BE-8510SL, BE-8520SL



BE-8910SL



Destornillador Aislo Boca Recta BahcoFit



B196

Ø	L	€		
2.5 mm	75 mm	6,00	10	B196.025.075
3 mm	100 mm	5,90	10	B196.030.100
3.5 mm	100 mm	6,14	10	B196.035.100
4 mm	100 mm	7,16	10	B196.040.100
5.5 mm	125 mm	8,53	10	B196.055.125
6.5 mm	150 mm	10,92	10	B196.065.150
8 mm	175 mm	12,05	10	B196.080.175
10 mm	200 mm	15,76	10	B196.100.200
12 mm	200 mm	18,27	10	B196.120.200
2.5 mm	75 mm	6,73	1	SB196.025.075
3 mm	100 mm	6,63	1	SB196.030.100
3.5 mm	100 mm	6,90	1	SB196.035.100
4 mm	100 mm	7,88	1	SB196.040.100
5.5 mm	125 mm	9,27	1	SB196.055.125
6.5 mm	150 mm	11,64	1	SB196.065.150
8 mm	175 mm	12,79	1	SB196.080.175
10 mm	200 mm	16,49	1	SB196.100.200
12 mm	200 mm	19,05	1	SB196.120.200

SB: Presentación en clip



Destornillador Aislo PH BahcoFit



B197PH

		€		
PH0	75 mm	6,13	10	B197.000.075
PH1	80 mm	7,57	10	B197.001.080
PH1	150 mm	8,56	10	B197.001.150
PH2	100 mm	9,78	10	B197.002.100
PH2	175 mm	11,76	10	B197.002.175
PH3	150 mm	12,52	10	B197.003.150
PH4	200 mm	18,54	10	B197.004.200
PH0	75 mm	6,88	1	SB197.000.075
PH1	80 mm	8,34	1	SB197.001.080
PH2	100 mm	10,52	1	SB197.002.100
PH3	150 mm	13,29	1	SB197.003.150
PH4	200 mm	19,29	1	SB197.004.200

SB: Presentación en clip

Destornillador BahcoFit Aislo PZ



B142PZ

		€		
PZ0	75 mm	6,79	10	B142.000.075
PZ1	80 mm	8,15	10	B142.001.080
PZ1	150 mm	9,57	10	B142.001.150
PZ2	100 mm	10,15	10	B142.002.100
PZ2	175 mm	11,82	10	B142.002.175
PZ3	150 mm	15,29	10	B142.003.150
PZ0	75 mm	7,55	1	SB142.000.075
PZ1	80 mm	8,89	1	SB142.001.080
PZ2	100 mm	10,92	1	SB142.002.100
PZ3	150 mm	16,05	1	SB142.003.150

SB: Presentación en clip

Destornilladores aislados ERGO™ punta TORX®



B150TORX

		€		
T10	100 mm	6,29	10	B150.010.100
T15	125 mm	6,33	10	B150.015.125
T20	125 mm	6,46	10	B150.020.125

		€		
T25	150 mm	6,68	10	B150.025.150
T10	100 mm	7,05	1	SB150.010.100
T15	125 mm	7,10	1	SB150.015.125
T20	125 mm	7,21	1	SB150.020.125
T25	150 mm	7,44	1	SB150.025.150

Destornillador combi Phillips aislado



B148

		€		
5.0mm/PH1	80 mm	8,15	10	B148.001.080
6.0mm/PH2	100 mm	10,02	10	B148.002.100
5.0mm/PH1	80 mm	10,53	1	SB148.001.080
6.0mm/PH2	100 mm	11,17	1	SB148.002.100

Destornillador BahcoFit Stecker Aislo



B199

		€		
5.5 mm	125 mm	11,27	5	B199.055.125
6 mm	125 mm	12,29	5	B199.060.125
7 mm	125 mm	13,17	5	B199.070.125
8 mm	125 mm	14,55	5	B199.080.125
9 mm	125 mm	16,16	5	B199.090.125
10 mm	125 mm	17,87	5	B199.100.125
11 mm	125 mm	19,56	5	B199.110.125
12 mm	125 mm	21,82	5	B199.120.125
13 mm	125 mm	24,21	5	B199.130.125
5.5 mm	125 mm	12,04	1	SB199.055.125
6 mm	125 mm	13,04	1	SB199.060.125
7 mm	125 mm	13,91	1	SB199.070.125
8 mm	125 mm	15,29	1	SB199.080.125
9 mm	125 mm	16,94	1	SB199.090.125
10 mm	125 mm	18,63	1	SB199.100.125
11 mm	125 mm	20,29	1	SB199.110.125
12 mm	125 mm	22,57	1	SB199.120.125
13 mm	125 mm	24,97	1	SB199.130.125

Destornillador combi Pozidriv aislado



B149

		€		
5.0mm/PZ1	80 mm	8,46	10	B149.001.080
6.0mm/PZ2	100 mm	10,34	10	B149.002.100
5.0mm/PZ1	80 mm	10,73	1	SB149.001.080
6.0mm/PZ2	100 mm	11,43	1	SB149.002.100

Juego 2 destornilladores BahcoFit aislados



B220.002

		€		
2	90 g	13,19	1	B220.002

B196.030.100

B197.001.080

Juego 2 destornilladores BahcoFit punta COMBI PL/PZ



B220.012

		€		
2	182 g	22,07	1	B220.012

B149.001.080, B149.002.100

Juego 5 destornilladores BahcoFit aislados PL/PH



B220.005

	€		
5	33,98	1	B220.005

B196.030.100, B196.040.100, B196.055.125		
B197.001.080, B197.002.100		

Juego 5 destornilladores BahcoFit aislados PL/PZ



B220.015

	€		
5	35,05	1	B220.015

B196.035.100, B196.040.100, B196.065.150		
B142.001.080, B142.002.100		

Juego 7 destornilladores BahcoFit aislados PL/PH



B220.007

	€		
7	50,02	1	B220.007

B196.030.100, B196.040.100, B196.055.125, B196.065.150		
B197.000.075, B197.001.080, B197.002.100		

Juego 7 destornilladores BahcoFit aislados PL/PZ



B220.017

	€		
7	52,43	1	B220.017

B196.025.075, B196.040.100, B196.055.125, B196.065.150		
B142.000.075, B142.001.080, B142.002.100		

Juego 7 destornilladores aislados BahcoFit PL/PH/TESTER



B220.027

	€		
7	46,32	1	B220.027

B196.030.100, B196.040.100, B196.055.125		
B197.000.075, B197.001.080, B197.002.100		
806-1-1		

Destornillador Aislado boca Recta



623

	€		
3.0 mm	100 mm	5,90	10 623-3-100
3.5 mm	100 mm	6,42	10 623-3.5-100
4.0 mm	100 mm	6,70	10 623-4-100
5.5 mm	125 mm	9,30	10 623-5.5-125
6.5 mm	150 mm	11,08	10 623-6.5-150

Destornillador Boca Phillips aislado



625PH

	€		
PH 0	100 mm	4,12	10 625-0-100
PH 1	150 mm	7,67	10 625-1-150
PH 2	175 mm	10,68	10 625-2-175

Juego 6 destornilladores aislados Serie 600



620-6

	€		
6	49,54	1	620-6

623-4-100, 623-3-100, 623-5.5-125, 623-6.5-150		
625-1-150, 625-2-175		



Juegostornillador a carraca con 6 varillas intercambiables 1000V



808061

		€		
7	85 x 85 x 218 mm	100,89	5	808061

Aislamiento integrado en varilla

808060		
8610SL-2P, 8620SL-2P		
8010SL-2P, 8050SL-2P, 8220SL-2P, 8040SL-2P		

Juego de destornillador a carraca 1000V con 6 varillas intercambiables



808062

		€		
7	85 x 85 x 215 mm	100,89	5	808062

808060		
8820SL-2P, 8810SL-2P		
8010SL-2P, 8050SL-2P, 8220SL-2P, 8040SL-2P		

Destornillador a carraca para varillas intercambiables 1000V



808060

		€		
36 mm	122 mm	39,96	1	808060

Carraca 48 dientes

Pack de 2 varillas intercambiables con aislamiento integrado



8010SL-2P - 8050SL-2P

		€		
0.4 mm	2.5 mm	13,04	1	8010SL-2P
0.5 mm	3.0 mm	13,04	1	8220SL-2P
0.8 mm	4.0 mm	13,70	1	8040SL-2P
1.0 mm	5.5 mm	13,70	1	8050SL-2P

Pack de 2 varillas intercambiables PH aisladas, 100mm



8610SL-2P - 8620SL-2P

	€		
1	13,70	1	8610SL-2P
2	13,70	1	8620SL-2P

Pack de 2 varillas intercambiables PZ aisladas, 100mm



8810SL-2P - 8820SL-2P

	€		
1	13,70	1	8810SL-2P
2	13,70	1	8820SL-2P

Varillas intercambiables aisladas con diámetro reducido



8510SL-2P - 8520SL-2P

	€		
5.0/PH1	20,31	1	8510SL-2P
6.0/PH2	20,31	1	8520SL-2P

Pack de 2 varillas intercambiables Combi (recta-PZ) aisladas, 100mm



8710SL-2P - 8720SL-2P

	€		
5.0/PZ1	20,31	1	8710SL-2P
6.0/PZ2	20,31	1	8720SL-2P

Pack de 2 varillas intercambiables TORX® aisladas, 100mm



8910SL-2P - 8930SL-2P

	€		
10	15,23	1	8910SL-2P
15	15,23	1	8915SL-2P
20	15,23	1	8920SL-2P
25	15,23	1	8925SL-2P
30	15,23	1	8930SL-2P

ALICATES AISLADOS

Alicates corte diagonal con filos progresivos de seguridad mangos aislados



ergo



2101S

		€		
3.7 mm	2.0 mm	26,11	3	2101S-140
3.8 mm	2.5 mm	28,14	3	2101S-160
4.0 mm	2.7 mm	31,47	3	2101S-180

Alicate de corte diagonal aislado con filos progresivos



2101S-200



Gu	Fe+	€		
4.5 mm	3.0 mm	38,80	3	2101S-200

Alicate cortacables de seguridad



2250V



L		€		
170 mm	0-10 mm	109,12	2	2250V-170
230 mm	0-15 mm	127,15	2	2250V-230

Alicates universales de seguridad mangos aislados



ergo



2628S



Fe+	Plano	€		
2.0 mm	1.8 mm	29,81	3	2628 S-160
2.5 mm	2.0 mm	33,03	3	2628 S-180
3.0 mm	2.5 mm	36,12	3	2628 S-200

Alicate de seguridad corte lateral 1000V



2171V



Gu	L	€		
2.7 mm	160 mm	41,49	2	2171V-160
2.8 mm	180 mm	44,49	2	2171V-180
4.0 mm	200 mm	48,05	2	2171V-200

Cortavarillas de seguridad 1000V



2820VBC



L	€		
630 mm	227,32	1	2820VBC

Alicate ERGO™ universal cromado aislado. Filo de corte reforzado



ergo



2630SC



L	€		
180 mm	25,27	3	2630SC-180

Alicate corte frontal de seguridad



527V



Gu	L	€		
2 mm	160 mm	48,74	2	527V-160
2.5 mm	200 mm	53,47	2	527V-200

Alicate de corte lateral cromado plateado, 1000V aislado



2674 NVDE



Gu	Fe+	€		
3.7 mm	2.0 mm	86,16	1	2674 NVDE

Alicate universal de seguridad



2678V



Gu	L	€		
2.7 mm	160 mm	41,78	2	2678V-160
3.0 mm	180 mm	45,55	2	2678V-180
4.0 mm	200 mm	48,99	2	2678V-200



Alicate boca semirredonda de seguridad mangos aislados



ergo®



2430S



Cu	Pu	€		
2.5 mm	1.8 mm	27,11	3	2430S-140
3.0 mm	1.8 mm	27,76	3	2430 S-160
3.0 mm	1.8 mm	30,43	3	2430 S-200

Alicates ERGO™ de boca redonda mangos aislados



ergo®



2521S



L	€		
140 mm	32,34	3	2521S-140
160 mm	34,03	3	2521S-160

Alicate boca plana de seguridad



2421V



L	€		
160 mm	38,70	2	2421V-160

Alicate boca semirredonda aislado con bocas curvadas 45°



ergo®



2427S



Cu	Pu	€		
3.0 mm	1.8 mm	33,72	3	2427S-160
3.0 mm	1.8 mm	33,98	3	2427 S-200

Alicate boca semirredonda de seguridad mangos aislados



2430V



Cu	L	€		
3.0 mm	160 mm	46,13	2	2430V-160
3.0 mm	200 mm	46,45	2	2430V-200

Alicate boca redonda de seguridad 1000V



2521V



L	€		
160 mm	39,32	2	2521V-160

Alicates ERGO™ de boca plana y cabeza larga, aislados



ergo®



2421S



L	€		
140 mm	32,60	3	2421S-140
160 mm	32,60	3	2421S-160
180 mm	43,32	3	2421S-180

Alicate boca semirredonda 60° de seguridad



2427V



Cu	L	€		
3.0 mm	200 mm	52,01	2	2427V-200

Pelacables aislado 1000V



ergo®



2223S



L	€		
165 mm	33,03	3	2223 S-150

Pelacables de seguridad



2223V

L	W	€	PK	Code
160 mm	0.5-5 mm	52,01	2	2223V-160



Tenacilla articulada ajustable aislada para trabajos en equipos de hasta 1000V



7224S

L	€	PK	Code
16 250 mm	39,34	4	7224S



ISO 8976, IEC 60900

LLAVES AISLADAS

Llave ajustable de seguridad 1000 V



8070V - 8074V

L	€	PK	Code
165mm/6"	39,14	2	8070V
205mm/8"	47,59	2	8071V
260mm/10"	53,05	2	8072V
310mm/12"	70,38	2	8073V
390mm/15"	113,80	2	8074V



Llave ajustable moleta lateral de seguridad



8070VL-8073VL

L	€	PK	Code
160mm/6"	47,79	1	8070VL
210mm/8"	55,77	1	8071VL
260mm/10"	65,75	1	8072VL
310mm/12"	86,29	1	8073VL



Llave ajustable de seguridad, moleta lateral



8071VLT - 8073VLT

L	€	PK	Code
205mm/8"	157,67	1	8071VLT
255mm/10"	176,30	1	8072VLT
305mm/12"	192,08	1	8073VLT



Llave fija de una boca 1000V



6MV

W	€	PK	Code
6 mm	24,09	5	6MV-6
7 mm	24,41	5	6MV-7
8 mm	22,18	5	6MV-8
9 mm	23,21	5	6MV-9
10 mm	23,48	5	6MV-10
11 mm	23,63	5	6MV-11
12 mm	24,81	5	6MV-12
13 mm	26,07	5	6MV-13
14 mm	26,07	5	6MV-14
15 mm	25,96	5	6MV-15
16 mm	27,35	5	6MV-16
17 mm	27,86	3	6MV-17
18 mm	28,50	3	6MV-18
19 mm	29,57	3	6MV-19
20 mm	31,01	3	6MV-20
21 mm	33,43	3	6MV-21
22 mm	34,88	3	6MV-22
23 mm	38,87	3	6MV-23



W	€	PK	Code
24 mm	40,35	3	6MV-24
27 mm	46,52	2	6MV-27
30 mm	51,87	2	6MV-30
32 mm	53,14	2	6MV-32

Llave estrella acodada de una boca 1000V



2MV

W	€	PK	Code
6.0 mm	28,70	5	2MV-6
7.0 mm	28,70	5	2MV-7
8.0 mm	30,22	5	2MV-8
9.0 mm	30,82	5	2MV-9
10.0 mm	30,73	5	2MV-10
11.0 mm	31,01	5	2MV-11
12.0 mm	31,01	5	2MV-12
13.0 mm	33,26	5	2MV-13
14.0 mm	34,19	5	2MV-14
15.0 mm	35,46	5	2MV-15
16.0 mm	35,95	5	2MV-16
17.0 mm	37,05	3	2MV-17
18.0 mm	37,71	3	2MV-18
19.0 mm	38,97	3	2MV-19
21.0 mm	41,01	3	2MV-21
22.0 mm	41,32	3	2MV-22
23.0 mm	44,02	3	2MV-23
24.0 mm	45,44	3	2MV-24



Llave de tubo con mango en "T" 1000V



28MV

W	€	PK	Code
8.0 mm	36,51	2	28MV-8
9.0 mm	36,51	2	28MV-9
10.0 mm	36,85	2	28MV-10
11.0 mm	37,32	2	28MV-11
12.0 mm	37,65	2	28MV-12
13.0 mm	37,97	2	28MV-13
14.0 mm	42,54	2	28MV-14
15.0 mm	43,03	2	28MV-15
16.0 mm	44,18	2	28MV-16
17.0 mm	44,81	2	28MV-17
18.0 mm	46,07	2	28MV-18
19.0 mm	46,07	2	28MV-19
20.0 mm	45,92	2	28MV-20
21.0 mm	46,24	2	28MV-21
22.0 mm	48,45	2	28MV-22



Llave hexagonal macho acodada 1000V



1999MV



Ø	€		
3 mm	15,40	5	1999MV-3
4 mm	15,95	5	1999MV-4
5 mm	15,79	5	1999MV-5
6 mm	16,10	5	1999MV-6
7 mm	16,86	5	1999MV-7
8 mm	17,81	5	1999MV-8
9 mm	18,42	5	1999MV-9
10 mm	19,97	3	1999MV-10
12 mm	22,45	3	1999MV-12

VASOS Y CARRACAS AISLADOS

Llave de vaso de 1/2" 1000V



7800DMV



Ø	€		
8 mm	23,98	10	7800DMV-8
10 mm	24,68	10	7800DMV-10
11 mm	24,68	10	7800DMV-11
12 mm	24,68	10	7800DMV-12
13 mm	24,68	10	7800DMV-13
14 mm	24,54	10	7800DMV-14
15 mm	24,54	10	7800DMV-15
16 mm	25,23	10	7800DMV-16
17 mm	25,39	10	7800DMV-17
18 mm	25,00	10	7800DMV-18
19 mm	25,72	10	7800DMV-19
20 mm	26,10	10	7800DMV-20
21 mm	25,71	10	7800DMV-21
22 mm	25,87	10	7800DMV-22
24 mm	27,24	5	7800DMV-24
27 mm	28,08	5	7800DMV-27
30 mm	30,58	5	7800DMV-30
32 mm	31,73	5	7800DMV-32

Llave de carraca de 1/2" de seguridad 1000V



8150-1/2V



L	€		
270 mm	195,16	1	8150-1/2V

Mango en "T" de 1/2" de seguridad 1000V



8154-1/2V



L	€		
200 mm	62,24	1	8154-1/2V

Alargadera de 1/2" de seguridad, 1000V



8160-1/2V - 8162-1/2V



L	€		
125 mm	46,61	1	8160-1/2V
250 mm	49,91	1	8162-1/2V

TIJERAS Y CUCHILLOS AISLADOS

Tijera para electricista aislada



SC127V



Ø	L	€	
50 mm	130 mm	23,79	5 SC127V

Tijera para electricista de seguridad



SC150NGV



Ø	L	€	
38 mm	150 mm	36,71	5 SC150NGV

Cuchillo recto aislado



2820VP



Ø	L	€	
50 mm	180 mm	30,08	2 2820VP

Cuchillo curvo de seguridad



2820VPC



		€		
50 mm	180 mm	32,63	2	2820VPC

Cuchillo curvo con protección aislado



2820VHELP



		€		
38 mm	180 mm	59,99	1	2820VHELP

Cuchillo aislado con capuchon protector de plástico



2820VDE



		€		
55.5 mm	180 mm	24,33	10	2820VDE

PINZAS AISLADAS

Pinzas de seguridad



2820VTEE



	€		
145 mm	32,29	1	2820VTEE

EQUIPOS DE PROTECCIÓN

Empuñadura de seguridad



2820VFP



	€		
458 g	122,19	1	2820VFP

Alfombra aislada 1000V



2820VM



		€		
1000 mm	1000 mm	227,90	1	2820VM

Guantes aislados



2820VG



	€		
500 V	68,52	1	2820VG05
1000 V	82,41	1	2820VG10

Guantes de algodón



2820VGCOT

	€		
50 g	4,89	1	2820VGCOT

JUEGOS DE HERRAMIENTAS AISLADAS

Juego de alicates universales aislados ERGO™ (3 piezas)



ergo



9897S/3

		€		
3	50 x 180 x 400 mm	92,80	1	9897S/3

2628 S-180



2101S-160



2430 S-200



Juego de 8 llaves fijas, 1000V



6MV/



	€		
8 mm	210,84	1	6MV/8T

6MV-10, 6MV-11, 6MV-12, 6MV-13, 6MV-14, 6MV-17, 6MV-18, 6MV-19	1000 V IEC60900	
--	-----------------	--

Juego de 10 llaves fijas, 1000V



6MV/10T_1



	€		
10 mm	282,64	1	6MV/10T

6MV-10, 6MV-11, 6MV-12, 6MV-13, 6MV-14, 6MV-16, 6MV-17, 6MV-18, 6MV-19, 6MV-22	1000 V IEC60900	
--	-----------------	--

Juego de 11 herramientas aisladas



7811DMV



		€	
11	270 x 79 x 350 mm	534,04	1 7811DMV

7800DMV-13, 7800DMV-10, 7800DMV-11, 7800DMV-22, 7800DMV-17, 7800DMV-19, 7800DMV-20	1000 V IEC60900	
8150-1/2V	1000 V IEC60900	
8154-1/2V	1000 V IEC60900	
8160-1/2V	1000 V IEC60900	
BE-8050S		

Juego de 10 herramientas para electricista



3045/1VDE



		€	
10	225 x 70 x 300 mm	443,51	1 3045/1VDE

BE-8010S, BE-8040S, BE-8050S, BE-8220S, BE-8230S, BE-8255S		
BE-8620S		
2171V-160	1000 V IEC60900	
2430V-160	1000 V IEC60900	
2678V-180	1000 V IEC60900	

Juego de 10 herramientas aisladas



3045V-1



		€	
10	60 x 240 x 330 mm	303,63	1 3045V-1

2171V-160	1000 V IEC60900	
2678V-180	1000 V IEC60900	
2223V-160	1000 V IEC60900	
BE-8220S, BE-8040S, BE-8050S		
BE-8610S, BE-8620S		
2820VP	1000 V IEC60900	
SC127V	1000 V IEC60900	

Maleta cuero portaherramientas para electricista 1000V



3045V-2



		€	
19	200 x 285 x 445 mm	759,63	1 3045V-2

Incluye set 19 herramientas: TS200

2171V-160	1000 V IEC60900	
2678V-180	1000 V IEC60900	
2430V-160	1000 V IEC60900	
2223V-160	1000 V IEC60900	
BE-8220S, BE-8040S, BE-8050S, BE-8255S		
BE-8610S, BE-8620S		
6MV-10, 6MV-11, 6MV-13, 6MV-12, 6MV-14, 6MV-17, 6MV-19	1000 V IEC60900	
2820VP	1000 V IEC60900	
SC150NGV	1000 V IEC60900	



Herramientas antichispa



LLAVES ANTICHISPA

Llave ajustable anti chispa, AL-BR



NS001

Icon	L	€	Icon	Icon
18 mm	150mm/6"	104,53	5	NS001-150
24 mm	200mm/8"	119,66	5	NS001-200
30 mm	250mm/10"	160,91	5	NS001-250
36 mm	300mm/12"	204,94	5	NS001-300
46 mm	375mm/15"	316,33	5	NS001-375
55 mm	450mm/18"	440,13	3	NS001-450
65 mm	600mm/24"	715,21	1	NS001-600
75 mm	900mm/36"	1.608,05	1	NS001-900

Llave ajustable anti chispa, CU-BE



NSB001

Icon	L	€	Icon	Icon
18 mm	150mm/6"	148,54	5	NSB001-150
24 mm	200mm/8"	185,67	5	NSB001-200
30 mm	250mm/10"	247,58	5	NSB001-250
36 mm	300mm/12"	275,08	5	NSB001-300
48 mm	375mm/15"	417,45	5	NSB001-375
55 mm	450mm/18"	567,02	3	NSB001-450
65 mm	600mm/24"	1.046,88	3	NSB001-600
75 mm	900mm/36"	2.343,32	1	NSB001-900

BAM/ZBF/003/21

Llave combinada anti chispa, AL-BR



NS002

Icon	€	Icon	Icon
6 mm	34,97	5	NS002-6
7 mm	39,64	5	NS002-7
8 mm	39,64	5	NS002-8
9 mm	40,96	5	NS002-9
10 mm	35,62	10	NS002-10
11 mm	44,65	5	NS002-11
12 mm	44,65	5	NS002-12

Icon	€	Icon	Icon
13 mm	44,65	10	NS002-13
14 mm	47,29	5	NS002-14
15 mm	49,92	5	NS002-15
16 mm	52,55	5	NS002-16
17 mm	65,67	10	NS002-17
18 mm	68,30	5	NS002-18
19 mm	70,92	10	NS002-19
20 mm	73,56	5	NS002-20
21 mm	76,18	5	NS002-21
22 mm	78,80	10	NS002-22
23 mm	84,07	5	NS002-23
24 mm	89,33	10	NS002-24
25 mm	91,94	5	NS002-25
26 mm	105,09	5	NS002-26
27 mm	105,09	5	NS002-27
28 mm	113,61	5	NS002-28
29 mm	116,25	10	NS002-29
30 mm	124,77	10	NS002-30
31 mm	131,36	5	NS002-31
32 mm	137,91	5	NS002-32
33 mm	150,46	5	NS002-33
34 mm	154,18	5	NS002-34
35 mm	157,62	5	NS002-35
36 mm	164,19	5	NS002-36
38 mm	170,75	5	NS002-38
40 mm	183,89	5	NS002-40
41 mm	210,15	5	NS002-41
42 mm	223,30	5	NS002-42
46 mm	236,44	5	NS002-46
50 mm	302,10	5	NS002-50
52 mm	304,75	5	NS002-52
55 mm	309,06	5	NS002-55
60 mm	343,49	1	NS002-60
65 mm	435,97	1	NS002-65
70 mm	502,04	1	NS002-70
75 mm	581,29	1	NS002-75
80 mm	686,98	1	NS002-80

BAM/ZBF/002/21

Llave combinada anti chispa, CU-BE



NSB002

Icon	€	Icon	Icon
6 mm	60,61	5	NSB002-6
7 mm	60,61	5	NSB002-7
8 mm	60,61	5	NSB002-8
9 mm	49,00	5	NSB002-9
10 mm	48,60	5	NSB002-10
11 mm	52,55	5	NSB002-11
12 mm	57,80	5	NSB002-12
13 mm	60,42	5	NSB002-13
17 mm	85,37	5	NSB002-17
14 mm	63,05	5	NSB002-14
15 mm	72,12	5	NSB002-15
16 mm	74,88	5	NSB002-16
18 mm	89,33	5	NSB002-18
19 mm	91,94	5	NSB002-19
20 mm	94,57	5	NSB002-20
21 mm	102,47	5	NSB002-21
22 mm	105,09	5	NSB002-22
25 mm	131,36	5	NSB002-25
23 mm	110,33	5	NSB002-23
26 mm	137,39	5	NSB002-26

Icon	€	Icon	Icon
24 mm	124,77	5	NSB002-24
27 mm	140,84	5	NSB002-27
28 mm	173,76	5	NSB002-28
29 mm	177,81	5	NSB002-29
30 mm	191,95	5	NSB002-30
31 mm	232,37	1	NSB002-31
32 mm	242,46	10	NSB002-32
33 mm	244,03	1	NSB002-33
34 mm	249,62	1	NSB002-34
35 mm	252,57	1	NSB002-35
36 mm	272,77	5	NSB002-36
38 mm	292,98	1	NSB002-38
40 mm	321,26	1	NSB002-40
41 mm	345,50	5	NSB002-41
42 mm	363,70	1	NSB002-42
46 mm	402,09	1	NSB002-46
50 mm	444,51	1	NSB002-50
52 mm	460,70	1	NSB002-52
55 mm	484,92	1	NSB002-55
60 mm	525,33	1	NSB002-60
65 mm	666,78	1	NSB002-65
70 mm	767,80	1	NSB002-70
75 mm	889,05	1	NSB002-75
80 mm	1.050,68	1	NSB002-80

BAM/ZBF/003/21

LLAVES COMBINADAS EN PULGADAS ANTICHISPA DE ALUMINIO BRONCE



NS003



Icon	€	Icon	Icon
1/4 in	32,49	1	NS003-8
11/32 in	37,51	1	NS003-11
3/8 in	38,63	1	NS003-12
7/16 in	40,60	1	NS003-14
1/2 in	45,56	1	NS003-16
9/16 in	49,52	1	NS003-18
5/8 in	54,10	1	NS003-20
3/4 in	68,73	1	NS003-24
7/8 in	76,76	1	NS003-28
15/16 in	95,43	1	NS003-30

LLAVES COMBINADAS EN PULGADAS ANTICHISPA DE COBRE BERILIO



NSB003

Icon	€	Icon	Icon
1/4 in	1.518,53	1	NSB003-8
5/16 in	33,09	1	NSB003-10
11/32 in	28,02	1	NSB003-11
3/8 in	28,02	5	NSB003-12



	€		
13/32 in	33,09	1	NSB003-13
7/16 in	44,69	1	NSB003-14
1/2 in	78,38	5	NSB003-16
9/16 in	78,38	1	NSB003-18
19/32 in	82,34	1	NSB003-19
5/8 in	74,16	1	NSB003-20
11/16 in	49,31	5	NSB003-22
3/4 in	777,79	5	NSB003-24
25/32 in	1.137,58	1	NSB003-25
13/16 in	897,77	1	NSB003-26
7/8 in	1.415,63	5	NSB003-28
15/16 in	1.157,03	1	NSB003-30
31/32 in	1.353,28	1	NSB003-31
1 in	477,92	1	NSB003-32
1.1/16 in	438,56	1	NSB003-34
1.1/8 in	547,60	1	NSB003-36
1.3/16 in	602,70	1	NSB003-38
1.1/4 in	841,41	1	NSB003-40
1.5/16 in	670,60	1	NSB003-42
1.3/8 in	1.045,55	5	NSB003-44
1.7/16 in	51,48	1	NSB003-46
1.1/2 in	53,92	1	NSB003-48
1.9/16 in	109,62	1	NSB003-50
1.5/8 in	339,88	1	NSB003-52
1.11/16 in	349,84	1	NSB003-54
1.3/4 in	5,14	1	NSB003-56
1.13/16 in	5,34	1	NSB003-58
1.7/8 in	6,13	1	NSB003-60
1.15/16 in	6,32	1	NSB003-62
2 in	50,62	5	NSB003-64
2.1/8 in	111,80	1	NSB003-68
2.1/4 in	131,71	1	NSB003-72
2.1/2 in	40,81	1	NSB003-80
2.5/8 in	918,07	1	NSB003-84
2.3/4 in	9,42	1	NSB003-88



BAM/ZBF/003/21

Llave Fija anti chispa, AL-BR



NS006

	€		
6x7 mm	17,98	1	NS006-0607
6x8 mm	18,31	1	NS006-0608
7x8 mm	17,99	1	NS006-0708
7x9 mm	18,29	1	NS006-0709
8x9 mm	17,99	1	NS006-0809
8x10 mm	19,04	1	NS006-0810
9x10 mm	19,37	1	NS006-0910
9x11 mm	23,28	1	NS006-0911
10x11 mm	22,59	1	NS006-1011
10x12 mm	25,39	1	NS006-1012
10x13 mm	25,82	1	NS006-1013
10x14 mm	26,03	1	NS006-1014
11x13 mm	29,63	1	NS006-1113
11x14 mm	30,12	1	NS006-1114
12x13 mm	28,24	1	NS006-1213
12x14 mm	38,57	1	NS006-1214
13x15 mm	42,32	1	NS006-1315
14x15 mm	33,89	1	NS006-1415
14x16 mm	42,32	1	NS006-1416
14x17 mm	33,89	1	NS006-1417
16x17 mm	36,70	1	NS006-1617



	€		
16x18 mm	36,70	1	NS006-1618
17x19 mm	36,70	1	NS006-1719
17x22 mm	42,36	1	NS006-1722
18x19 mm	42,36	1	NS006-1819
18x20 mm	45,00	1	NS006-1820
19x20 mm	45,18	1	NS006-1920
19x22 mm	50,83	1	NS006-1922
19x24 mm	50,83	1	NS006-1924
20x22 mm	50,83	1	NS006-2022
21x22 mm	51,25	1	NS006-2122
21x23 mm	53,64	1	NS006-2123
22x23 mm	56,48	1	NS006-2223
22x24 mm	56,94	1	NS006-2224
22x27 mm	63,53	1	NS006-2227
23x26 mm	64,63	1	NS006-2326
24x25 mm	69,40	1	NS006-2425
24x26 mm	70,60	1	NS006-2426
24x27 mm	49,92	1	NS006-2427
24x30 mm	56,44	1	NS006-2430
25x28 mm	52,55	1	NS006-2528
26x29 mm	53,91	1	NS006-2629
27x29 mm	60,42	1	NS006-2729
27x30 mm	75,35	1	NS006-2730
27x32 mm	84,40	1	NS006-2732
28x30 mm	84,40	1	NS006-2830
30x31 mm	87,41	1	NS006-3031
30x32 mm	105,88	1	NS006-3032
30x34 mm	92,83	1	NS006-3034
30x36 mm	92,83	1	NS006-3036
32x34 mm	92,83	1	NS006-3234
32x35 mm	92,83	1	NS006-3235
32x36 mm	134,11	1	NS006-3236
33x35 mm	141,13	1	NS006-3335
34x36 mm	141,13	1	NS006-3436
35x36 mm	141,13	1	NS006-3536
36x38 mm	206,20	1	NS006-3638
36x41 mm	206,20	1	NS006-3641
38x42 mm	229,11	1	NS006-3642
41x46 mm	211,77	1	NS006-4146
46x50 mm	297,85	1	NS006-4650
50x52 mm	302,43	1	NS006-5052
50x55 mm	307,01	1	NS006-5055
50x60 mm	311,59	1	NS006-5060
50x62 mm	423,53	1	NS006-5062
55x60 mm	451,76	1	NS006-5560
60x65 mm	550,59	1	NS006-6065
65x70 mm	564,71	1	NS006-6570



BAM/ZBF/002/21

Llave fija anti chispa, CU-BE



NSB006

	€		
6X7 mm	22,74	1	NSB006-0607
6X8 mm	23,16	1	NSB006-0608
7X8 mm	25,76	1	NSB006-0708
7X9 mm	26,19	1	NSB006-0709

	€		
8X9 mm	25,78	1	NSB006-0809
8X10 mm	27,28	1	NSB006-0810
9X10 mm	27,73	1	NSB006-0910
9X11 mm	33,34	1	NSB006-0911
10X11 mm	33,89	1	NSB006-1011
10X12 mm	36,70	1	NSB006-1012
10X13 mm	37,32	1	NSB006-1013
10X14 mm	39,53	1	NSB006-1014
11X13 mm	45,00	1	NSB006-1113
11X14 mm	45,75	1	NSB006-1114
12X13 mm	45,18	1	NSB006-1213
12X14 mm	45,55	1	NSB006-1214
13X15 mm	49,98	1	NSB006-1315
14X15 mm	50,83	1	NSB006-1415
14X16 mm	59,36	1	NSB006-1416
14X17 mm	60,85	1	NSB006-1417
16X17 mm	59,30	1	NSB006-1617
16X18 mm	59,77	1	NSB006-1618
17X19 mm	67,96	1	NSB006-1719
17X22 mm	75,52	1	NSB006-1722
18X19 mm	76,78	1	NSB006-1819
18X20 mm	77,41	1	NSB006-1820
19X20 mm	78,67	1	NSB006-1920
19X22 mm	79,93	1	NSB006-1922
19X24 mm	88,26	1	NSB006-1924
20X22 mm	87,53	1	NSB006-2022
21X22 mm	88,26	1	NSB006-2122
21X23 mm	88,97	1	NSB006-2123
22X23 mm	89,68	1	NSB006-2223
22X24 mm	90,40	1	NSB006-2224
22X27 mm	95,50	1	NSB006-2227
23X26 mm	102,60	1	NSB006-2326
24X25 mm	104,31	1	NSB006-2425
24X26 mm	106,01	1	NSB006-2426
24X27 mm	115,96	1	NSB006-2427
24x30 mm	117,42	1	NSB006-2430
25x28 mm	119,37	1	NSB006-2528
26x29 mm	128,84	1	NSB006-2629
27-29 mm	128,84	1	NSB006-2729
27x30 mm	128,84	1	NSB006-2730
27x32 mm	144,29	1	NSB006-2732
28x30 mm	144,29	1	NSB006-2830
30x31 mm	149,45	1	NSB006-3031
30x32 mm	155,30	1	NSB006-3032
30x34 mm	164,94	1	NSB006-3034
30x36 mm	164,94	1	NSB006-3036
32x34 mm	164,94	1	NSB006-3234
32x35 mm	164,94	1	NSB006-3235
32x36 mm	164,94	1	NSB006-3236
33x35 mm	164,94	1	NSB006-3335
34x36 mm	164,94	1	NSB006-3436
35x36 mm	164,94	1	NSB006-3536
36x38 mm	240,97	1	NSB006-3638
36x41 mm	240,97	1	NSB006-3641
38x42 mm	267,75	1	NSB006-3642
41x46 mm	310,59	1	NSB006-4146
46x50 mm	381,17	1	NSB006-4650
50x52 mm	387,05	1	NSB006-5052
50X55 mm	392,90	1	NSB006-5055
50X60 mm	398,76	1	NSB006-5060
50X62 mm	404,63	1	NSB006-5062
55X60 mm	516,05	1	NSB006-5560
60X65 mm	539,51	1	NSB006-6065
65X70 mm	574,69	1	NSB006-6570

BAM/ZBF/003/21



Llave estrella plana anti chispa, AL-BR



NS010

Icon	€	Icon	Icon
6x7 mm	35,45	1	NS010-0607
7x9 mm	35,45	1	NS010-0709
8x9 mm	37,62	1	NS010-0809
9x11 mm	39,80	1	NS010-0911
10x11 mm	39,80	1	NS010-1011
10x12 mm	41,34	1	NS010-1012
12x14 mm	42,91	1	NS010-1214
13x15 mm	50,99	1	NS010-1315
14x17 mm	50,99	1	NS010-1417
16x18 mm	67,77	1	NS010-1618
17x19 mm	74,61	1	NS010-1719
17x22 mm	82,07	1	NS010-1722
18x19 mm	74,61	1	NS010-1819
19x21 mm	90,77	1	NS010-1921
19x22 mm	92,93	1	NS010-1922
20x22 mm	95,12	1	NS010-2022
21x23 mm	102,59	1	NS010-2123
22x24 mm	111,91	1	NS010-2224
24x27 mm	131,80	1	NS010-2427
25x28 mm	147,36	1	NS010-2528
26x28 mm	150,38	1	NS010-2628
27x30 mm	153,42	1	NS010-2730
27x32 mm	169,26	1	NS010-2732
30x32 mm	179,68	1	NS010-3032
30x36 mm	224,58	1	NS010-3036
32x36 mm	269,51	1	NS010-3236
36x41 mm	404,26	1	NS010-3641
41x46 mm	440,77	1	NS010-4146
46x50 mm	468,31	1	NS010-4650

BAM/ZBF/002/21

Llave estrella plana anti chispa, CU-BE



NSB010

Icon	€	Icon	Icon
6X7 mm	47,42	1	NSB010-0607
7X9 mm	47,42	1	NSB010-0709
8X9 mm	46,45	1	NSB010-0809
9X11 mm	50,06	1	NSB010-0911

Icon	€	Icon	Icon
------	---	------	------

10X11 mm	50,06	1	NSB010-1011
10X12 mm	55,48	1	NSB010-1012
12X14 mm	60,93	1	NSB010-1214
13X15 mm	72,74	1	NSB010-1315
14X17 mm	72,74	1	NSB010-1417
16X18 mm	96,98	1	NSB010-1618
17X19 mm	106,95	1	NSB010-1719
17X22 mm	115,31	1	NSB010-1722
18X19 mm	106,95	1	NSB010-1819
19X21 mm	117,35	1	NSB010-1921
19X22 mm	118,25	1	NSB010-1922
20X22 mm	119,14	1	NSB010-2022
21X23 mm	127,84	1	NSB010-2123
22X24 mm	151,79	1	NSB010-2224
24X27 mm	164,83	1	NSB010-2427
25X28 mm	183,84	1	NSB010-2528
26X28 mm	194,48	1	NSB010-2628
27X30 mm	205,10	1	NSB010-2730
27X32 mm	212,38	1	NSB010-2732
30X32 mm	239,20	1	NSB010-3032
30X36 mm	299,01	1	NSB010-3036
32X36 mm	358,80	1	NSB010-3236
36X41 mm	538,19	1	NSB010-3641
41X46 mm	650,31	1	NSB010-4146
46X50 mm	731,60	1	NSB010-4650

BAM/ZBF/003/21

Llaves fijas estrella acodada anti chispa, AL-BR



NS011

Icon	€	Icon	Icon
6x7 mm	24,85	1	NS011-0607
8x9 mm	26,83	1	NS011-0809
10x11 mm	32,47	1	NS011-1011
12x13 mm	42,36	1	NS011-1213
14x15 mm	48,01	1	NS011-1415
16x17 mm	52,24	1	NS011-1617
18x19 mm	64,94	1	NS011-1819
20x22 mm	76,22	1	NS011-2022
21x23 mm	79,08	1	NS011-2123
24x26 mm	96,83	1	NS011-2426
25x28 mm	96,83	1	NS011-2528
27x29 mm	106,62	1	NS011-2729
30x32 mm	130,56	1	NS011-3032

BAM/ZBF/002/21

Llaves fijas estrella acodada anti chispa, CU-BE



NSB011

Icon	€	Icon	Icon
6x7 mm	29,65	1	NSB011-0607
8x9 mm	32,01	1	NSB011-0809
10x11 mm	40,95	1	NSB011-1011
12x13 mm	59,30	1	NSB011-1213
14x15 mm	73,41	1	NSB011-1415
16x17 mm	84,70	1	NSB011-1617
18x19 mm	107,29	1	NSB011-1819
20x22 mm	129,87	1	NSB011-2022
21x23 mm	135,52	1	NSB011-2123
24x26 mm	167,51	1	NSB011-2426
25x28 mm	168,02	1	NSB011-2528
27x29 mm	182,12	1	NSB011-2729
30x32 mm	225,87	1	NSB011-3032



BAM/ZBF/003/21

Llave de golpe boca fija anti chispa, AL-BR



NS100

Icon	€	Icon	Icon
17 mm	77,16	1	NS100-17
19 mm	80,23	1	NS100-19
22 mm	83,33	1	NS100-22
24 mm	89,49	1	NS100-24
25 mm	100,32	1	NS100-25
27 mm	101,25	1	NS100-27
28 mm	102,22	1	NS100-28
29 mm	104,92	1	NS100-29
30 mm	105,92	1	NS100-30
32 mm	111,49	1	NS100-32
33 mm	118,05	1	NS100-33
34 mm	140,21	1	NS100-34
35 mm	146,60	1	NS100-35
36 mm	148,00	1	NS100-36
37 mm	162,03	1	NS100-37
38 mm	163,56	1	NS100-38
41 mm	177,45	1	NS100-41
42 mm	207,96	1	NS100-42



	€		
45 mm	223,76	1	NS100-45
46 mm	225,89	1	NS100-46
47 mm	243,05	1	NS100-47
50 mm	262,33	1	NS100-50
52 mm	288,57	1	NS100-52
54 mm	300,92	1	NS100-54
55 mm	300,92	1	NS100-55
56 mm	315,24	1	NS100-56
58 mm	378,05	1	NS100-58
60 mm	381,66	1	NS100-60
63 mm	404,92	1	NS100-63
65 mm	416,64	1	NS100-65
67 mm	495,99	1	NS100-67
70 mm	547,81	1	NS100-70
71 mm	573,90	1	NS100-71
75 mm	616,88	1	NS100-75
77 mm	688,70	1	NS100-77
80 mm	727,46	1	NS100-80
82 mm	797,72	1	NS100-82
85 mm	828,87	1	NS100-85
88 mm	939,09	1	NS100-88
90 mm	847,06	1	NS100-90
94 mm	868,40	1	NS100-94
95 mm	847,06	1	NS100-95
100 mm	1.300,30	1	NS100-100
105 mm	1.581,89	1	NS100-105
110 mm	1.400,91	1	NS100-110
115 mm	1.678,68	1	NS100-115
120 mm	1.795,53	1	NS100-120



BAM/ZBF/002/21

Llave de golpe boca fija anti chispa,
CU-BE



NSB100

	€		
17 mm	101,02	1	NSB100-17
19 mm	105,08	1	NSB100-19
22 mm	109,12	1	NSB100-22
24 mm	117,21	1	NSB100-24
25 mm	131,33	1	NSB100-25
27 mm	131,33	1	NSB100-27
28 mm	131,33	1	NSB100-28
29 mm	161,64	1	NSB100-29
30 mm	161,64	1	NSB100-30
32 mm	163,00	1	NSB100-32
33 mm	181,86	1	NSB100-33
34 mm	181,86	1	NSB100-34
35 mm	191,95	1	NSB100-35
36 mm	191,95	1	NSB100-36
37 mm	212,16	1	NSB100-37



	€		
38 mm	212,16	1	NSB100-38
41 mm	232,37	1	NSB100-41
42 mm	267,21	1	NSB100-42
45 mm	292,98	1	NSB100-45
46 mm	292,98	1	NSB100-46
47 mm	318,22	1	NSB100-47
50 mm	343,50	1	NSB100-50
52 mm	377,84	1	NSB100-52
54 mm	394,01	1	NSB100-54
55 mm	394,01	1	NSB100-55
56 mm	409,82	1	NSB100-56
58 mm	491,47	1	NSB100-58
60 mm	496,18	1	NSB100-60
63 mm	526,40	1	NSB100-63
65 mm	541,63	1	NSB100-65
67 mm	644,79	1	NSB100-67
70 mm	712,15	1	NSB100-70
71 mm	746,07	1	NSB100-71
75 mm	801,95	1	NSB100-75
77 mm	895,31	1	NSB100-77
80 mm	945,69	1	NSB100-80
82 mm	1.037,01	1	NSB100-82
85 mm	1.077,52	1	NSB100-85
88 mm	1.220,81	1	NSB100-88
90 mm	1.364,10	1	NSB100-90
94 mm	1.398,51	1	NSB100-94
95 mm	1.433,36	1	NSB100-95
100 mm	1.552,87	1	NSB100-100
105 mm	1.835,21	1	NSB100-105
110 mm	1.976,44	1	NSB100-110
115 mm	2.368,29	1	NSB100-115
120 mm	2.533,18	1	NSB100-120



BAM/ZBF/003/21

Llave estrella de golpeo anti chispa, AL-BR



NS104

	€		
17 mm	84,08	1	NS104-17
19 mm	85,62	1	NS104-19
20 mm	86,37	1	NS104-20
22 mm	87,14	1	NS104-22
24 mm	88,68	1	NS104-24
25 mm	99,67	1	NS104-25
26 mm	99,72	1	NS104-26
27 mm	99,72	1	NS104-27
28 mm	104,62	1	NS104-28
29 mm	106,95	1	NS104-29
30 mm	111,10	1	NS104-30
31 mm	114,64	1	NS104-31
32 mm	116,54	1	NS104-32

	€		
33 mm	127,87	1	NS104-33
34 mm	135,22	1	NS104-34
35 mm	138,75	1	NS104-35
36 mm	136,00	1	NS104-36
37 mm	136,63	1	NS104-37
38 mm	142,40	1	NS104-38
39 mm	172,15	1	NS104-39
40 mm	175,39	1	NS104-40
41 mm	178,31	1	NS104-41
42 mm	193,92	1	NS104-42
43 mm	198,98	1	NS104-43
44 mm	193,92	1	NS104-44
45 mm	197,30	1	NS104-45
46 mm	202,36	1	NS104-46
47 mm	219,07	1	NS104-47
48 mm	222,88	1	NS104-48
49 mm	226,70	1	NS104-49
50 mm	230,50	1	NS104-50
51 mm	236,24	1	NS104-51
52 mm	242,04	1	NS104-52
53 mm	243,97	1	NS104-53
54 mm	245,91	1	NS104-54
55 mm	262,69	1	NS104-55
56 mm	269,82	1	NS104-56
57 mm	274,33	1	NS104-57
58 mm	278,82	1	NS104-58
59 mm	283,32	1	NS104-59
60 mm	308,67	1	NS104-60
61 mm	319,64	1	NS104-61
62 mm	326,08	1	NS104-62
63 mm	336,30	1	NS104-63
64 mm	346,47	1	NS104-64
65 mm	337,02	1	NS104-65
66 mm	327,91	1	NS104-66
67 mm	333,17	1	NS104-67
68 mm	402,24	1	NS104-68
69 mm	402,24	1	NS104-69
70 mm	380,90	1	NS104-70
71 mm	405,11	1	NS104-71
72 mm	407,99	1	NS104-72
73 mm	410,85	1	NS104-73
74 mm	413,73	1	NS104-74
75 mm	459,72	1	NS104-75
76 mm	478,15	1	NS104-76
77 mm	484,12	1	NS104-77
78 mm	498,24	1	NS104-78
79 mm	512,39	1	NS104-79
80 mm	526,53	1	NS104-80
81 mm	555,99	1	NS104-81
82 mm	562,55	1	NS104-82
83 mm	569,12	1	NS104-83
84 mm	575,68	1	NS104-84
85 mm	582,25	1	NS104-85
86 mm	644,98	1	NS104-86
87 mm	659,19	1	NS104-87
88 mm	673,39	1	NS104-88
89 mm	687,61	1	NS104-89
90 mm	647,85	1	NS104-90
92 mm	738,05	1	NS104-92
94 mm	747,26	1	NS104-94
95 mm	669,92	1	NS104-95
98 mm	794,85	1	NS104-98
100 mm	788,11	1	NS104-100
105 mm	853,79	1	NS104-105
110 mm	1.011,42	1	NS104-110
115 mm	1.011,42	1	NS104-115
120 mm	1.313,51	1	NS104-120

BAM/ZBF/002/21



Llave de estrella de golpe anti chispa, mm, CU-BE



NSB104

	€		
17 mm	98,52	1	NSB104-17
19 mm	101,15	1	NSB104-19
20 mm	106,40	1	NSB104-20
22 mm	108,00	1	NSB104-22
24 mm	109,00	1	NSB104-24
25 mm	129,61	1	NSB104-25
26 mm	129,62	1	NSB104-26
27 mm	137,91	1	NSB104-27
28 mm	136,00	1	NSB104-28
29 mm	139,03	1	NSB104-29
30 mm	144,50	1	NSB104-30
31 mm	149,04	1	NSB104-31
32 mm	157,62	1	NSB104-32
33 mm	149,04	1	NSB104-33
34 mm	149,04	1	NSB104-34
35 mm	149,04	1	NSB104-35
36 mm	183,89	1	NSB104-36
37 mm	200,60	1	NSB104-37
38 mm	217,80	1	NSB104-38
39 mm	254,56	1	NSB104-39
40 mm	268,23	1	NSB104-40
41 mm	288,97	1	NSB104-41
42 mm	296,60	1	NSB104-42
43 mm	304,34	1	NSB104-43
44 mm	296,60	1	NSB104-44
45 mm	301,77	1	NSB104-45
46 mm	309,51	1	NSB104-46
47 mm	335,06	1	NSB104-47
48 mm	340,88	1	NSB104-48
49 mm	346,72	1	NSB104-49
50 mm	361,22	1	NSB104-50
51 mm	361,22	1	NSB104-51
52 mm	380,90	1	NSB104-52
53 mm	373,11	1	NSB104-53
54 mm	376,08	1	NSB104-54
55 mm	400,63	1	NSB104-55
56 mm	412,67	1	NSB104-56
57 mm	419,56	1	NSB104-57
58 mm	426,43	1	NSB104-58
59 mm	433,30	1	NSB104-59
60 mm	440,19	1	NSB104-60
61 mm	456,65	1	NSB104-61
62 mm	465,84	1	NSB104-62
63 mm	480,43	1	NSB104-63
64 mm	494,96	1	NSB104-64
65 mm	481,46	1	NSB104-65
66 mm	501,51	1	NSB104-66
67 mm	509,53	1	NSB104-67
68 mm	615,18	1	NSB104-68
69 mm	615,18	1	NSB104-69
70 mm	615,21	1	NSB104-70
71 mm	619,57	1	NSB104-71
72 mm	623,97	1	NSB104-72
73 mm	628,36	1	NSB104-73
74 mm	632,77	1	NSB104-74
75 mm	637,16	1	NSB104-75
76 mm	668,36	1	NSB104-76

	€		
77 mm	676,70	1	NSB104-77
78 mm	696,44	1	NSB104-78
79 mm	716,25	1	NSB104-79
80 mm	736,02	1	NSB104-80
81 mm	777,18	1	NSB104-81
82 mm	786,35	1	NSB104-82
83 mm	795,52	1	NSB104-83
84 mm	804,69	1	NSB104-84
85 mm	813,88	1	NSB104-85
86 mm	901,59	1	NSB104-86
87 mm	921,44	1	NSB104-87
88 mm	941,29	1	NSB104-88
89 mm	961,17	1	NSB104-89
90 mm	905,58	1	NSB104-90
92 mm	1.031,65	1	NSB104-92
94 mm	1.044,56	1	NSB104-94
95 mm	1.057,48	1	NSB104-95
98 mm	1.215,65	1	NSB104-98
100 mm	1.239,35	1	NSB104-100
105 mm	1.315,39	1	NSB104-105
110 mm	1.539,87	1	NSB104-110
115 mm	2.310,95	1	NSB104-115
120 mm	1.975,17	1	NSB104-120

BAM/ZBF/003/21

Llave estrella de golpe anti chispa, AL-BR



NS106

	€		
5/8 in	60,62	1	NS106-20
11/16 in	76,94	1	NS106-22
3/4 in	81,07	1	NS106-24
25/32 in	86,85	1	NS106-25
13/16 in	88,41	1	NS106-26
7/8 in	91,25	1	NS106-28
15/16 in	92,79	1	NS106-30
1 in	94,30	1	NS106-32
1 1/16 in	97,34	1	NS106-34
1 1/8 in	100,39	1	NS106-36
1 3/16 in	103,30	1	NS106-38
1 1/4 in	105,09	1	NS106-40
1 5/16 in	97,59	1	NS106-42
1 3/8 in	100,13	1	NS106-44
1 13/32 in	102,47	1	NS106-45
1 7/16 in	133,91	1	NS106-46
1 1/2 in	135,90	1	NS106-48
1 9/16 in	141,36	1	NS106-50
1 5/8 in	171,13	1	NS106-52
1 11/16 in	154,78	1	NS106-54
1 3/4 in	158,55	1	NS106-56
1 13/16 in	197,01	1	NS106-58
1 7/8 in	215,12	1	NS106-60
1 15/16 in	195,96	1	NS106-62
2 in	229,10	1	NS106-64
2 1/16 in	214,47	1	NS106-66
2 1/8 in	226,82	1	NS106-68
2 3/16 in	239,20	1	NS106-70
2 13/64 in	239,20	1	NS106-71
2 1/4 in	280,77	1	NS106-72

	€		
2 5/16 in	295,54	1	NS106-74
2 3/8 in	302,10	1	NS106-76
2 7/16 in	286,45	1	NS106-78
2 1/2 in	315,25	1	NS106-80
2 9/16 in	316,03	1	NS106-82
2 5/8 in	328,37	1	NS106-84
2 3/4 in	394,04	1	NS106-88
2 13/16 in	405,60	1	NS106-90
2 7/8 in	423,23	1	NS106-92
2 15/16 in	446,59	1	NS106-94
3 in	472,86	1	NS106-96
3 1/16 in	462,94	1	NS106-98
3 1/8 in	634,88	1	NS106-100
3 1/4 in	652,51	1	NS106-104
3 3/8 in	668,82	1	NS106-108
3 1/2 in	692,18	1	NS106-112
3 9/16 in	731,87	1	NS106-114
3 5/8 in	828,20	1	NS106-116
3 3/4 in	863,55	1	NS106-120
3 7/8 in	932,62	1	NS106-124
3 15/16 in	1.007,22	1	NS106-126
4 in	1.047,52	1	NS106-128
4 1/8 in	1.087,81	1	NS106-132
4 1/4 in	1.265,21	1	NS106-136
4 5/16 in	1.296,82	1	NS106-138
4 1/2 in	1.547,52	1	NS106-144
4 9/16 in	1.566,62	1	NS106-146
4 11/16 in	1.661,61	1	NS106-150
4 7/8 in	1.857,11	1	NS106-156
4 15/16 in	2.657,99	1	NS106-158



BAM/ZBF/002/21

Llave de estrella de golpe anti chispa, pulgadas, CU-BE



NSB106

	€		
5/8 in	105,08	1	NSB106-20
11/16 in	117,69	1	NSB106-22
3/4 in	123,98	1	NSB106-24
25/32 in	96,63	1	NSB106-25
13/16 in	110,69	1	NSB106-26
7/8 in	131,84	1	NSB106-28
15/16 in	134,00	1	NSB106-30
1 in	136,23	1	NSB106-32
1.1/16 in	140,62	1	NSB106-34
1.1/8 in	145,02	1	NSB106-36
1.3/16 in	149,21	1	NSB106-38
1.1/4 in	164,79	1	NSB106-40
1.5/16 in	169,16	1	NSB106-42
1.3/8 in	173,58	1	NSB106-44
1.13/32 in	219,21	1	NSB106-45
1.7/16 in	232,14	1	NSB106-46
1.1/2 in	235,58	1	NSB106-48
1.9/16 in	245,02	1	NSB106-50
1.5/8 in	261,74	1	NSB106-52
1.11/16 in	282,40	1	NSB106-54
1.3/4 in	288,97	1	NSB106-56
1.13/16 in	317,08	1	NSB106-58
1.7/8 in	354,65	1	NSB106-60

	€		
1.15/16 in	367,79	1	NSB106-62
2 in	385,99	1	NSB106-64
2.1/16 in	367,79	1	NSB106-66
2.1/8 in	380,90	1	NSB106-68
2.3/16 in	394,04	1	NSB106-70
2.13/64 in	399,00	1	NSB106-71
2.1/4 in	427,37	1	NSB106-72
2.5/16 in	427,37	1	NSB106-74
2.3/8 in	441,15	1	NSB106-76
2.7/16 in	496,46	1	NSB106-78
2.1/2 in	502,95	1	NSB106-80
2.9/16 in	483,35	1	NSB106-82
2.5/8 in	527,29	1	NSB106-84
2.3/4 in	659,12	1	NSB106-88
2.13/16 in	660,00	1	NSB106-90
2.7/8 in	732,61	1	NSB106-92
2.15/16 in	745,89	1	NSB106-94
3 in	756,56	1	NSB106-96
3.1/16 in	802,41	1	NSB106-98
3.1/8 in	825,32	1	NSB106-100
3.1/4 in	848,24	1	NSB106-104
3.3/8 in	869,44	1	NSB106-108
3.1/2 in	899,86	1	NSB106-112
3.9/16 in	951,39	1	NSB106-114
3.5/8 in	1.076,65	1	NSB106-116
3.3/4 in	1.122,59	1	NSB106-120
3.7/8 in	1.212,40	1	NSB106-124
3.15/16 in	1.309,39	1	NSB106-126
4 in	1.361,79	1	NSB106-128
4.1/8 in	1.414,18	1	NSB106-132
4.1/4 in	1.644,78	1	NSB106-136
4.5/16 in	1.685,89	1	NSB106-138
4.1/2 in	2.011,79	1	NSB106-144
4.9/16 in	2.749,44	1	NSB106-146
4.11/16 in	2.818,14	1	NSB106-150
4.7/8 in	2.826,31	1	NSB106-156
4.15/16 in	3.454,89	1	NSB106-158



BAM/ZBF/003/21

HERRAMIENTAS PARA FONTANERÍA

Llave Stillson anti chispa, AL-BR



NS200



	€		
25 mm	200 mm	196,47	1 NS200-200
30 mm	250 mm	228,15	1 NS200-250
40 mm	300 mm	247,18	1 NS200-300
50 mm	350 mm	291,53	1 NS200-350
60 mm	450 mm	493,78	1 NS200-450
75 mm	600 mm	728,33	1 NS200-600
85 mm	900 mm	1.255,20	1 NS200-900
110 mm	1200 mm	1.715,14	1 NS200-1200

BAM/ZBF/002/21

Llave Stillson anti chispa, CU-BE



NSB200

	€		
25 mm	200 mm	313,17	1 NSB200-200
30 mm	250 mm	363,70	1 NSB200-250
40 mm	300 mm	394,01	1 NSB200-300
50 mm	350 mm	464,73	1 NSB200-350
60 mm	450 mm	565,76	1 NSB200-450
75 mm	600 mm	848,62	1 NSB200-600
85 mm	900 mm	1.474,99	1 NSB200-900
110 mm	1200 mm	2.687,31	1 NSB200-1200

BAM/ZBF/003/21

Llave de válvulas larga anti chispa, AL-BR



NS202

€		
370 mm	255,96	1 NS202-350

BAM/ZBF/002/21

Llave válvulas anti chispa, CU-BE



NSB202



€		
375 mm	301,93	1 NSB202-350



BAM/ZBF/003/21

Llave para válvulas anti-chispa, AL-BR



NS203

€		
215 mm	24 mm	85,70 1 NS203-200
215 mm	32 mm	128,48 1 NS203-215



€		
290 mm	36 mm	139,82 1 NS203-290
400 mm	48 mm	183,74 1 NS203-400
490 mm	60 mm	273,19 1 NS203-490
800 mm	60 mm	647,86 1 NS203-800

BAM/ZBF/002/21

Llave para válvulas anti-chispa, CU-BE



NSB203



€		
215 mm	24 mm	128,27 1 NSB203-200
215 mm	32 mm	183,54 1 NSB203-215
290 mm	36 mm	213,58 1 NSB203-290
400 mm	48 mm	262,48 1 NSB203-400
490 mm	60 mm	390,23 1 NSB203-490
800 mm	60 mm	925,54 1 NSB203-800

BAM/ZBF/003/21

Llave-gancho girador de válvulas anti chispa, AL-BR



NS204

€		
200 mm	149,30	1 NS204-30
300 mm	203,18	1 NS204-32
250 mm	168,20	1 NS204-35
300 mm	203,18	1 NS204-40
350 mm	223,95	1 NS204-45
375 mm	246,63	1 NS204-48
400 mm	260,79	1 NS204-50
450 mm	271,19	1 NS204-55
500 mm	289,15	1 NS204-60
550 mm	324,12	1 NS204-65
600 mm	362,86	1 NS204-70
650 mm	405,39	1 NS204-75
700 mm	463,03	1 NS204-80
750 mm	521,61	1 NS204-85
800 mm	548,08	1 NS204-90

BAM/ZBF/002/21



Llave válvulas anti chispa, CU-BE



NSB204

L	€		
200 mm	234,36	1	NSB204-30
300 mm	322,21	1	NSB204-32
250 mm	260,79	1	NSB204-35
300 mm	322,21	1	NSB204-40
350 mm	393,10	1	NSB204-45
375 mm	426,18	1	NSB204-48
400 mm	452,63	1	NSB204-50
450 mm	540,50	1	NSB204-55
500 mm	582,10	1	NSB204-60
550 mm	663,35	1	NSB204-65
600 mm	728,56	1	NSB204-70
650 mm	810,77	1	NSB204-75
700 mm	922,28	1	NSB204-80
750 mm	1.026,22	1	NSB204-85
800 mm	1.132,05	1	NSB204-90

BAM/ZBF/003/21

LLAVES DE VASO Y CARRACAS ANTICHISPA

Vaso anti-chispa 1/2", AL-BR



NS220

Ø	L	€		
6 mm	40 mm	63,35	1	NS220-06
7 mm	40 mm	64,94	1	NS220-07
8 mm	40 mm	66,52	1	NS220-08
9 mm	40 mm	68,10	1	NS220-09
10 mm	40 mm	69,70	1	NS220-10
11 mm	40 mm	71,26	1	NS220-11
12 mm	40 mm	72,86	1	NS220-12
13 mm	40 mm	74,45	1	NS220-13
14 mm	40 mm	76,04	1	NS220-14
15 mm	40 mm	77,61	1	NS220-15
16 mm	40 mm	79,20	1	NS220-16

Ø	L	€		
17 mm	40 mm	85,53	1	NS220-17
18 mm	42 mm	87,10	1	NS220-18
19 mm	42 mm	88,69	1	NS220-19
20 mm	42 mm	90,28	1	NS220-20
21 mm	43 mm	95,04	1	NS220-21
22 mm	43 mm	98,20	1	NS220-22
23 mm	43 mm	101,37	1	NS220-23
24 mm	43 mm	107,69	1	NS220-24
25 mm	43 mm	110,87	1	NS220-25
26 mm	43 mm	118,79	1	NS220-26
27 mm	46 mm	123,55	1	NS220-27
28 mm	46 mm	126,71	1	NS220-28
29 mm	46 mm	138,24	1	NS220-29
30 mm	46 mm	139,38	1	NS220-30
32 mm	46 mm	142,55	1	NS220-32
34 mm	50 mm	123,41	1	NS220-34
36 mm	50 mm	135,75	1	NS220-36
41 mm	55 mm	164,99	1	NS220-41

BAM/ZBF/002/21

Vaso anti-chispa 1/2", CU-BE



NSB220

Ø	L	€		
6 mm	40 mm	71,65	1	NSB220-06
7 mm	40 mm	73,43	1	NSB220-07
8 mm	40 mm	75,23	1	NSB220-08
9 mm	40 mm	77,03	1	NSB220-09
10 mm	40 mm	71,40	1	NSB220-10
11 mm	40 mm	75,09	1	NSB220-11
12 mm	40 mm	80,01	1	NSB220-12
13 mm	41 mm	83,71	1	NSB220-13
14 mm	40 mm	84,93	1	NSB220-14
15 mm	40 mm	87,40	1	NSB220-15
16 mm	40 mm	90,47	1	NSB220-16
17 mm	41 mm	92,94	1	NSB220-17
18 mm	42 mm	96,01	1	NSB220-18
19 mm	42 mm	100,33	1	NSB220-19
20 mm	42 mm	101,56	1	NSB220-20
21 mm	43 mm	104,62	1	NSB220-21
22 mm	43 mm	108,32	1	NSB220-22
23 mm	44 mm	114,64	1	NSB220-23
24 mm	43 mm	121,80	1	NSB220-24
25 mm	44 mm	136,63	1	NSB220-25
26 mm	43 mm	146,49	1	NSB220-26
27 mm	47 mm	153,87	1	NSB220-27
28 mm	46 mm	162,49	1	NSB220-28
29 mm	47 mm	175,04	1	NSB220-29
30 mm	46 mm	180,95	1	NSB220-30
32 mm	47 mm	198,80	1	NSB220-32

BAM/ZBF/003/21

Vaso anti-chispa 3/4", AL-BR



NS224

Ø	L	€		
17 mm	50 mm	86,88	1	NS224-17
18 mm	50 mm	87,15	1	NS224-18
19 mm	50 mm	87,42	1	NS224-19
21 mm	55 mm	96,15	1	NS224-21
22 mm	55 mm	97,18	1	NS224-22
23 mm	55 mm	102,66	1	NS224-23
24 mm	55 mm	128,85	1	NS224-24
26 mm	55 mm	130,21	1	NS224-26
27 mm	55 mm	138,14	1	NS224-27
28 mm	55 mm	145,04	1	NS224-28
29 mm	55 mm	155,09	1	NS224-29
30 mm	60 mm	163,55	1	NS224-30
32 mm	60 mm	184,72	1	NS224-32
34 mm	60 mm	199,55	1	NS224-34
36 mm	60 mm	212,77	1	NS224-36
38 mm	60 mm	227,60	1	NS224-38
41 mm	65 mm	250,89	1	NS224-41
46 mm	65 mm	296,39	1	NS224-46
50 mm	70 mm	324,99	1	NS224-50

BAM/ZBF/002/21

Vaso anti-chispa 3/4", CU-BE



NSB224

Ø	L	€		
17 mm	50 mm	119,72	1	NSB224-17
18 mm	50 mm	147,70	1	NSB224-18
19 mm	50 mm	120,26	1	NSB224-19
21 mm	55 mm	132,43	1	NSB224-21
22 mm	55 mm	135,60	1	NSB224-22
23 mm	55 mm	169,54	1	NSB224-23
24 mm	56 mm	152,26	1	NSB224-24
26 mm	55 mm	158,43	1	NSB224-26
27 mm	55 mm	161,21	1	NSB224-27
28 mm	55 mm	171,08	1	NSB224-28
29 mm	55 mm	207,28	1	NSB224-29
30 mm	60 mm	219,84	1	NSB224-30
32 mm	61 mm	247,84	1	NSB224-32
34 mm	60 mm	266,69	1	NSB224-34
36 mm	61 mm	286,50	1	NSB224-36
38 mm	60 mm	305,84	1	NSB224-38
41 mm	66 mm	336,26	1	NSB224-41

Ø	L	€	📦	🐟
46 mm	65 mm	397,62	1	NSB224-46
50 mm	71 mm	435,79	1	NSB224-50

BAM/ZBF/003/21

Vaso anti-chispa 1", AL-BR



NS228

Ø	L	€	📦	🐟
22 mm	55 mm	127,64	1	NS228-22
24 mm	55 mm	140,95	1	NS228-24
26 mm	55 mm	174,22	1	NS228-26
27 mm	55 mm	180,25	1	NS228-27
28 mm	55 mm	183,89	1	NS228-28
29 mm	55 mm	188,13	1	NS228-29
30 mm	60 mm	192,35	1	NS228-30
31 mm	60 mm	208,09	1	NS228-31
32 mm	60 mm	222,60	1	NS228-32
34 mm	60 mm	234,71	1	NS228-34
36 mm	65 mm	251,65	1	NS228-36
38 mm	65 mm	270,99	1	NS228-38
41 mm	70 mm	307,89	1	NS228-41
46 mm	75 mm	342,38	1	NS228-46
50 mm	75 mm	376,25	1	NS228-50
55 mm	80 mm	424,64	1	NS228-55
60 mm	85 mm	474,24	1	NS228-60
65 mm	90 mm	526,26	1	NS228-65
70 mm	90 mm	579,50	1	NS228-70
75 mm	95 mm	632,73	1	NS228-75
80 mm	95 mm	687,78	1	NS228-80

BAM/ZBF/002/21

Vaso anti-chispa 1", CU-BE



NSB228

Ø	g	€	📦	🐟
22 mm	370 g	170,16	1	NSB228-22
24 mm	430 g	197,02	1	NSB228-24
26 mm	396 g	214,94	1	NSB228-26
27 mm	440 g	232,86	1	NSB228-27
28 mm	411 g	229,87	1	NSB228-28

Ø	g	€	📦	🐟
29 mm	460 g	268,66	1	NSB228-29
30 mm	462 g	286,57	1	NSB228-30
31 mm	520 g	270,15	1	NSB228-31
32 mm	497 g	302,70	1	NSB228-32
34 mm	506 g	358,22	1	NSB228-34
36 mm	610 g	376,13	1	NSB228-36
38 mm	600 g	394,04	1	NSB228-38
41 mm	740 g	403,00	1	NSB228-41
46 mm	832 g	438,83	1	NSB228-46
50 mm	960 g	465,66	1	NSB228-50
55 mm	1130 g	510,48	1	NSB228-55
60 mm	1570 g	635,85	1	NSB228-60
65 mm	1698 g	680,62	1	NSB228-65
70 mm	2350 g	752,27	1	NSB228-70
75 mm	3010 g	893,77	1	NSB228-75
80 mm	2818 g	949,28	1	NSB228-80

BAM/ZBF/003/21

Adaptador anti-chispa, AL-BR



NS232

Ø	Ø	€	📦	🐟
1/2"	3/4"	124,02	1	NS232-16-24
3/4"	1/2"	151,27	1	NS232-24-16
3/4"	1"	253,04	1	NS232-24-32
1"	3/4"	245,70	1	NS232-32-24

BAM/ZBF/002/21

Adaptador anti-chispa, CU-BE



NSB232

Ø	Ø	€	📦	🐟
1/2"	3/4"	176,83	1	NSB232-16-24
3/4"	1/2"	213,47	1	NSB232-24-16
3/4"	1"	359,63	1	NSB232-24-32
1"	3/4"	348,10	1	NSB232-32-24

BAM/ZBF/003/21

Alargadera anti-chispa, AL-BR



NS234

Ø	Ø	€	📦	🐟
1/2"	1/2"	120,26	1	NS234-16-100
1/2"	1/2"	132,06	1	NS234-16-200
1/2"	1/2"	145,04	1	NS234-16-250
3/4"	3/4"	198,07	1	NS234-24-200
1"	1"	341,94	1	NS234-32-250

BAM/ZBF/002/21

Alargadera anti-chispa, CU-BE



NSB234

L	Ø	€	📦	🐟
100 mm	16.4 mm	150,97	1	NSB234-16-100
200 mm	16.4 mm	167,22	1	NSB234-16-200
250 mm	16.4 mm	162,58	1	NSB234-16-250
200 mm	25 mm	234,57	1	NSB234-24-200
250 mm	34 mm	488,50	1	NSB234-32-250

BAM/ZBF/003/21

Junta universal anti-chispa, AL-BR



NS236

Ø	Ø	€	📦	🐟
1/2"	1/2"	146,99	1	NS236-16
3/4"	3/4"	354,77	1	NS236-24
1"	1"	484,52	1	NS236-32

BAM/ZBF/002/21



Junta universal anti-chispa, CU-BE



NSB236

1/2"	3/4"	1"	€	Icon	Icon
1/2"	1/2"	224,16	1	NSB236-16	
3/4"	3/4"	464,51	1	NSB236-24	
1"	1"	707,32	1	NSB236-32	

BAM/ZBF/003/21

Mango acodado en T anti-chispa, AL-BR



NS240

1/2"	L	€	Icon	Icon
1/2"	230 mm	189,92	1	NS240-16-230

BAM/ZBF/002/21

Llave de carraca anti-chispa, CU-BE



NSB242

1/2"	L	€	Icon	Icon
1/2"	245 mm	255,48	1	NSB242-16
3/4"	320 mm	510,96	1	NSB242-24
1"	550 mm	1.068,36	1	NSB242-32

BAM/ZBF/003/21

Mango corredizo en T anti-chispa, AL-BR



NS238

1/2"	L	€	Icon	Icon
1/2"	250 mm	206,35	1	NS238-16-250
3/4"	260 mm	409,14	1	NS238-24-250
1"	300 mm	514,09	1	NS238-32-300

BAM/ZBF/002/21

Mango acodado en T anti-chispa, CU-BE



NSB240

1/2"	g	€	Icon	Icon
1/2"	370 g	219,21	1	NSB240-16-230

BAM/ZBF/003/21

Berbiquí anti-chispa, AL-BR



NS243

1/2"	L	€	Icon	Icon
1/2"	390 mm	241,91	1	NS243-16-400

BAM/ZBF/002/21

Mango corredizo en T anti-chispa, CU-BE



NSB238

1/2"	L	€	Icon	Icon
1/2"	250 mm	174,18	1	NSB238-16-250
3/4"	250 mm	267,09	1	NSB238-24-250
1"	300 mm	487,74	1	NSB238-32-300

BAM/ZBF/003/21

Llave de carraca anti-chispa, AL-BR



NS242

1/2"	L	€	Icon	Icon
1/2"	245 mm	308,92	1	NS242-16
3/4"	320 mm	496,40	1	NS242-24
1"	550 mm	962,92	1	NS242-32

BAM/ZBF/002/21

Berbiquí anti-chispa, CU-BE



NSB243

1/2"	L	€	Icon	Icon
1/2"	395 mm	339,22	1	NSB243-16-400

BAM/ZBF/003/21

Vaso anti-chispa para bujías, AL-BR



NS247

		€		
1/2"	13 mm	146,32	1	NS247-26

BAM/ZBF/002/21

Vaso anti-chispa para bujías, CU-BE



NSB247

		€		
1/2"	13 mm	220,64	1	NSB247-26

BAM/ZBF/003/21

Destornillador Stecker anti-chispa, AL-BR



NS248

	€		
13 mm	78,33	1	NS248-16-52

BAM/ZBF/002/21

Destornillador Stecker anti-chispa, CU-BE



NSB248

	€		
13 mm	110,66	1	NSB248-16-52

BAM/ZBF/003/21

DESTORNILLADORES ANTICHISPA

Destornillador punta plana ERGO™, AL-BR



NS300

		€		
3 mm	50 mm	16,94	1	NS300-3-50
3 mm	75 mm	19,76	1	NS300-3-75
4 mm	75 mm	21,18	1	NS300-4-75
4.5 mm	50 mm	18,36	1	NS300-4.5-50
4.5 mm	100 mm	25,67	1	NS300-4.5-100
5 mm	75 mm	22,59	1	NS300-5-75
5 mm	100 mm	25,40	1	NS300-5-100
6 mm	100 mm	26,83	1	NS300-6-100
6 mm	125 mm	30,39	1	NS300-6-125
6 mm	150 mm	33,57	1	NS300-6-150
7 mm	150 mm	38,00	1	NS300-7-150
8 mm	150 mm	41,34	1	NS300-8-150
8 mm	200 mm	49,43	1	NS300-8-200
9 mm	250 mm	56,48	1	NS300-9-250
10 mm	200 mm	71,51	1	NS300-10-200
10 mm	300 mm	93,25	1	NS300-10-300
11 mm	250 mm	85,48	1	NS300-11-250
11 mm	300 mm	101,02	1	NS300-11-300
11 mm	350 mm	116,56	1	NS300-11-350
12 mm	400 mm	122,78	1	NS300-12-400
13 mm	450 mm	132,11	1	NS300-13-450

BAM/ZBF/002/21

Destornillador boca Plana ERGO™ anti chispa, CU-BE



NSB300

		€		
3 mm	50 mm	21,00	1	NSB300-3-50
3 mm	75 mm	21,18	1	NSB300-3-75
4 mm	75 mm	26,83	1	NSB300-4-75
4.5 mm	60 mm	23,99	1	NSB300-4.5-50
4.5 mm	95 mm	27,73	1	NSB300-4.5-100
5 mm	75 mm	29,46	1	NSB300-5-75
5 mm	100 mm	28,24	1	NSB300-5-100
6 mm	105 mm	33,89	1	NSB300-6-100
6 mm	125 mm	33,89	1	NSB300-6-125
6 mm	160 mm	41,22	1	NSB300-6-150
7 mm	150 mm	41,22	1	NSB300-7-150
8 mm	150 mm	42,36	1	NSB300-8-150
8 mm	200 mm	65,25	1	NSB300-8-200
9 mm	250 mm	77,29	1	NSB300-9-250
9 mm	200 mm	91,76	1	NSB300-10-200
10 mm	318 mm	98,82	1	NSB300-10-300
11 mm	250 mm	105,88	1	NSB300-11-250
11 mm	300 mm	112,93	1	NSB300-11-300
11 mm	350 mm	141,17	1	NSB300-11-350
12 mm	400 mm	169,41	1	NSB300-12-400
13 mm	450 mm	197,64	1	NSB300-13-450

BAM/ZBF/003/21

Destornilladores electricista anti chispa, AL-BR



NS301

		€		
3 mm	50 mm	21,18	1	NS301-3-50
4 mm	100 mm	26,83	1	NS301-4-100
4 mm	150 mm	44,77	1	NS301-4-150
5 mm	100 mm	41,86	1	NS301-5-100
5 mm	200 mm	44,86	1	NS301-5-200
6 mm	100 mm	44,99	1	NS301-6-100
8 mm	150 mm	60,91	1	NS301-8-150
10 mm	200 mm	76,18	1	NS301-10-200
10 mm	300 mm	90,55	1	NS301-10-300

BAM/ZBF/002/21



Destornilladores electricista, CU-BE



ergo



NSB301

Tip	Length	€	Box	Weight
3 mm	50 mm	30,83	1	NSB301-3-50
4 mm	100 mm	40,19	1	NSB301-4-100
4 mm	150 mm	52,92	1	NSB301-4-150
5 mm	100 mm	49,27	1	NSB301-5-100
5 mm	210 mm	70,60	1	NSB301-5-200
6 mm	100 mm	70,60	1	NSB301-6-100
8 mm	155 mm	84,70	1	NSB301-8-150
10 mm	200 mm	81,27	1	NSB301-10-200
10 mm	300 mm	100,13	1	NSB301-10-300

BAM/ZBF/003/21

Destornillador punta PH ERGO™, AL-BR



ergo



NS302

Tip	Length	€	Box	Weight
PH0	50 mm	23,99	1	NS302-0-50
PH1	100 mm	23,99	1	NS302-1-100
PH2	125 mm	30,57	1	NS302-2-125
PH3	150 mm	42,36	1	NS302-3-150
PH4	300 mm	67,77	1	NS302-4-300

BAM/ZBF/002/21

Destornilladores Phillips ERGO™ anti chispa, CU-BE



ergo



NSB302

Tip	Length	€	Box	Weight
PH0	65 mm	31,06	1	NSB302-0-50
PH1	120 mm	31,06	1	NSB302-1-100
PH2	125 mm	33,89	1	NSB302-2-125
PH3	150 mm	49,43	1	NSB302-3-150
PH4	300 mm	77,66	1	NSB302-4-300

BAM/ZBF/003/21

Destornillador punta PZ ERGO™, AL-BR



ergo



NS304

Tip	Length	€	Box	Weight
PZ0	50 mm	23,99	1	NS304-0-50
PZ1	100 mm	23,99	1	NS304-1-100
PZ2	125 mm	28,24	1	NS304-2-125
PZ3	150 mm	42,36	1	NS304-3-150
PZ4	300 mm	67,77	1	NS304-4-300

BAM/ZBF/002/21

Destornillador PZ ERGO™ anti chispa, CU-BE



ergo



NSB304

Tip	Length	€	Box	Weight
PZ0	50 mm	31,06	1	NSB304-0-50
PZ1	100 mm	31,06	1	NSB304-1-100
PZ2	125 mm	33,89	1	NSB304-2-125
PZ3	150 mm	42,36	1	NSB304-3-150
PZ4	300 mm	77,66	1	NSB304-4-300

BAM/ZBF/003/21

Llaves allen anti chispa, AL-BR



NS320

Tip	Length	€	Box	Weight
2 mm	59 mm	30,75	1	NS320-2
3 mm	59 mm	31,12	1	NS320-3
4 mm	65 mm	31,61	1	NS320-4
5 mm	79 mm	32,98	1	NS320-5
6 mm	85 mm	34,39	1	NS320-6
7 mm	88 mm	38,08	1	NS320-7
8 mm	92 mm	39,95	1	NS320-8
9 mm	99 mm	44,15	1	NS320-9
10 mm	110 mm	47,41	1	NS320-10

BAM/ZBF/002/21

Llaves hexagonales anti chispa, CU-BE



NSB320

Tip	Length	€	Box	Weight
2 mm	59 mm	43,91	1	NSB320-2
3 mm	59 mm	44,44	1	NSB320-3
4 mm	65 mm	45,14	1	NSB320-4
5 mm	79 mm	47,10	1	NSB320-5
6 mm	85 mm	49,12	1	NSB320-6
7 mm	88 mm	54,38	1	NSB320-7
8 mm	93 mm	57,07	1	NSB320-8
9 mm	97 mm	63,04	1	NSB320-9
10 mm	110 mm	67,68	1	NSB320-10

BAM/ZBF/003/21

ALICATES ANTICHISPA

Alicates universal anti chispa, AL-BR



NS400

Length	€	Box	Weight
155 mm	127,05	1	NS400-160
175 mm	141,17	1	NS400-180
200 mm	155,30	1	NS400-200

BAM/ZBF/002/21

Alicates universal anti chispa, CU-BE



NSB400

Length	€	Box	Weight
157 mm	169,41	1	NSB400-160
175 mm	183,53	1	NSB400-180
200 mm	197,64	1	NSB400-200

BAM/ZBF/003/21

Alicate de corte lateral anti chispa, AL-BR

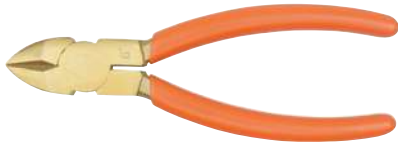

NS402

L	€	Icon	Icon
150 mm	165,00	1	NS402-160
200 mm	169,41	1	NS402-200

BAM/ZBF/002/21

Alicate de corte lateral anti chispa, CU-BE



NSB402

L	€	Icon	Icon
155 mm	206,09	1	NSB402-160
200 mm	253,86	1	NSB402-200

BAM/ZBF/003/21

Alicates corte diagonal HD anti chispa, AL-BR



NS403

L	€	Icon	Icon
150 mm	155,30	1	NS403-160
180 mm	169,41	1	NS403-180

BAM/ZBF/002/21

Alicates corte diagonal heavy duty anti chispa CU-BE



NSB403

L	€	Icon	Icon
155 mm	249,90	1	NSB403-160
180 mm	262,67	1	NSB403-180

BAM/ZBF/003/21

Alicates boca plana anti chispa, AL-BR



NS404

L	€	Icon	Icon
150 mm	119,99	1	NS404-160

BAM/ZBF/002/21

Alicates boca plana anti chispa, CU-BE



NSB404

L	€	Icon	Icon
155 mm	155,30	1	NSB404-160

BAM/ZBF/003/21

Alicates boca semirredonda anti chispa, AL-BR



NS405

L	€	Icon	Icon
160 mm	119,99	1	NS405-160

BAM/ZBF/002/21

Alicates boca redonda anti chispa, CU-BE



NSB405

L	€	Icon	Icon
155 mm	270,97	1	NSB405-160

BAM/ZBF/003/21

Alicate de punta semiredonda anti chispa, AL-BR



NS406

L	€	Icon	Icon
160 mm	127,05	1	NS406-160
180 mm	152,13	1	NS406-180
200 mm	152,88	1	NS406-200

BAM/ZBF/002/21

Alicate de boca semiredonda anti chispa, CU-BE



NSB406

L	€	Icon	Icon
155 mm	169,41	1	NSB406-160
180 mm	197,20	1	NSB406-180
200 mm	197,64	1	NSB406-200

BAM/ZBF/003/21

Pelacables anti chispa, AL-BR



NS407

L	€	Icon	Icon
170 mm	276,95	1	NS407-160

BAM/ZBF/002/21



Pelacables anti chispa, CU-BE

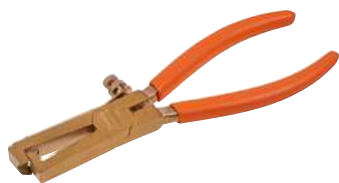

NSB407

L	€		
170 mm	372,09	1	NSB407-160

BAM/ZBF/003/21

Alicate articulado anti chispa, AL-BR



NS408

L	€		
260 mm	191,24	1	NS408-250
300 mm	231,59	1	NS408-300

BAM/ZBF/002/21

Tenacilla articulada anti chispa, CU-BE



NSB408

L	€		
255 mm	248,61	1	NSB408-250
300 mm	301,06	1	NSB408-300

BAM/ZBF/003/21

Tenazas anti chispa, AL-BR



NS412

L	€		
200 mm	112,93	1	NS412-200

BAM/ZBF/002/21

Tenazas anti chispa, CU-BE



NSB412

L	€		
200 mm	141,17	1	NSB412-200

BAM/ZBF/003/21

Alicatas para gas anti chispa, AL-BR



NS411

L	€		
200 mm	183,53	1	NS411-200

BAM/ZBF/002/21

Alicatas para Gas anti chispa, CU-BE



NSB411

L	€		
205 mm	363,70	1	NSB411-200

BAM/ZBF/003/21

Tenazas para carpinteros anti chispa, AL-BR



NS413

L	€		
180 mm	286,08	1	NS413-180
195 mm	286,08	1	NS413-200

BAM/ZBF/002/21

Tenazas para carpintero anti chispa, CU-BE



NSB413

L	€		
185 mm	371,90	1	NSB413-180
195 mm	371,90	1	NSB413-200

BAM/ZBF/003/21

MARTILLOS, PALANCAS Y CINCELES

Maza tipo alemán anti chispa, AL-BR



NS500

	€		
2000 g	271,58	1	NS500-2000
2500 g	339,38	1	NS500-2500
3000 g	407,18	1	NS500-3000
4000 g	539,76	1	NS500-4000

BAM/ZBF/002/21

Maceta cuadrada tipo alemán anti chispa mango madera, CU-BE



NSB500

	€		
2000 g	325,15	1	NSB500-2000
2500 g	383,22	1	NSB500-2500
3000 g	452,90	1	NSB500-3000
4000 g	454,59	1	NSB500-4000

BAM/ZBF/003/21

Maza tipo alemán mango fibra vidrio anti chispa



NS500-FB

	€		
1000 g	155,44	1	NS500-1000-FB
1500 g	179,24	1	NS500-1500-FB
2000 g	219,47	1	NS500-2000-FB
2500 g	275,28	1	NS500-2500-FB
3000 g	310,59	1	NS500-3000-FB
3500 g	438,92	1	NS500-3500-FB

BAM/ZBF/002/21

Maceta cuadrada tipo alemán anti chispa mango fibra de vidrio, CU-BE



NSB500-FB

	€		
1000 g	171,74	1	NSB500-1000-FB
1500 g	247,52	1	NSB500-1500-FB
2000 g	327,33	1	NSB500-2000-FB
2500 g	420,27	1	NSB500-2500-FB
3000 g	499,08	1	NSB500-3000-FB
3500 g	630,40	1	NSB500-3500-FB

BAM/ZBF/003/21

Maza mango fibra de vidrio anti chispa AL-BR



NS502-FB

	€		
450 g	88,33	1	NS502-450-FB
1000 g	118,81	1	NS502-1000-FB
1500 g	157,62	1	NS502-1500-FB
2000 g	192,19	1	NS502-2000-FB
2500 g	244,61	1	NS502-2500-FB

	€		
3000 g	297,02	1	NS502-3000-FB
4500 g	354,65	1	NS502-4500-FB
5000 g	420,32	1	NS502-5000-FB
6800 g	551,68	1	NS502-6800-FB
8000 g	660,00	1	NS502-8000-FB
10000 g	919,47	1	NS502-10000-FB
12000 g	1.050,82	1	NS502-12000-FB

BAM/ZBF/002/21

Martillo octogonal anti chispa mango fibra de vidrio, CU-BE



NSB502-FB

	€		
450 g	117,78	1	NSB502-450-FB
1000 g	164,44	1	NSB502-1000-FB
1500 g	219,25	1	NSB502-1500-FB
2000 g	301,48	1	NSB502-2000-FB
2500 g	383,69	1	NSB502-2500-FB
3000 g	465,91	1	NSB502-3000-FB
4500 g	616,65	1	NSB502-4500-FB
5000 g	671,46	1	NSB502-5000-FB
6800 g	931,82	1	NSB502-6800-FB
8000 g	986,63	1	NSB502-8000-FB
10000 g	1.444,87	1	NSB502-10000-FB
12000 g	1.971,63	1	NSB502-12000-FB

BAM/ZBF/003/21

Martillo tipo Alemán mango fibra de vidrio anti chispa, AL-BR



NS504-FB

	€		
100 g	56,48	1	NS504-100-FB
200 g	60,00	1	NS504-200-FB
300 g	64,94	1	NS504-300-FB
500 g	88,94	1	NS504-500-FB
800 g	117,16	1	NS504-800-FB
1000 g	155,44	1	NS504-1000-FB
1500 g	183,53	1	NS504-1500-FB
2000 g	225,87	1	NS504-2000-FB

BAM/ZBF/002/21

Martillo mecánico anti chispa mango fibra de vidrio, CU-BE



NSB504-FB

	€		
100 g	63,53	1	NSB504-100-FB
200 g	86,40	1	NSB504-200-FB
300 g	106,14	1	NSB504-300-FB
500 g	133,32	1	NSB504-500-FB
800 g	172,82	1	NSB504-800-FB
1000 g	209,85	1	NSB504-1000-FB
1500 g	283,93	1	NSB504-1500-FB
2000 g	343,18	1	NSB504-2000-FB

BAM/ZBF/003/21

Martillo de bola con mango de madera anti chispa, AL-BR



NS506

	€		
340 g	54,86	1	NS506-300
450 g	73,15	1	NS506-450
670 g	102,88	1	NS506-700
910 g	137,15	1	NS506-900

BAM/ZBF/002/21

Martillo de bola con mango de madera anti chispa, CU-BE



NSB506

	€		
300 g	74,08	1	NSB506-300
450 g	98,75	1	NSB506-450
680 g	138,88	1	NSB506-700
910 g	185,15	1	NSB506-900

BAM/ZBF/003/21



Martillo de bola anti chispa con mango de fibra de vidrio, AL-BR



NS506-FB

	€		
310 g	55,70	1	NS506-300-FB
470 g	74,26	1	NS506-450-FB
700 g	94,06	1	NS506-700-FB
910 g	143,13	1	NS506-900-FB

BAM/ZBF/002/21

Martillo de bola anti chispa con mango de fibra de vidrio, CU-BE



NSB506-FB

	€		
300 g	75,50	1	NSB506-300-FB
450 g	100,65	1	NSB506-450-FB
680 g	126,98	1	NSB506-700-FB
900 g	193,22	1	NSB506-900-FB

BAM/ZBF/003/21

Martillos mango fibra de vidrio anti chispa, AL-BR



NS508-FB

	€		
500 g	88,75	1	NS508-500-FB
700 g	104,88	1	NS508-700-FB

BAM/ZBF/002/21

Martillos mango fibra de vidrio anti chispa, CU-BE



NSB508-FB

	€		
500 g	111,13	1	NSB508-500-FB
700 g	131,33	1	NSB508-700-FB

BAM/ZBF/003/21

Martillo anti chispa, AL-BR



NS512-FB

	€		
230 g	75,83	1	NS512-200-FB
400 g	95,20	1	NS512-400-FB
640 g	104,88	1	NS512-600-FB
970 g	127,46	1	NS512-900-FB

BAM/ZBF/002/21

Martillos mango fibra de vidrio anti chispa, CU-BE



NSB512-FB

	€		
200 g	94,97	1	NSB512-200-FB
400 g	119,20	1	NSB512-400-FB
600 g	131,33	1	NSB512-600-FB
900 g	185,81	1	NSB512-900-FB

BAM/ZBF/003/21

Cuña anti chispa, AL-BR



NS600

L	€		
80 mm	9,87	1	NS600-80-13
100 mm	36,57	1	NS600-100-50
135 mm	69,50	1	NS600-135-50
150 mm	32,92	1	NS600-150-25
150 mm	29,28	1	NS600-150-30
150 mm	36,57	1	NS600-150-40
150 mm	62,18	1	NS600-150-50
180 mm	29,28	1	NS600-180-13
180 mm	42,06	1	NS600-180-32
180 mm	93,27	1	NS600-180-50
200 mm	82,30	1	NS600-200-20
200 mm	100,58	1	NS600-200-30
200 mm	147,65	1	NS600-200-40
200 mm	72,46	1	NS600-200-50
230 mm	106,08	1	NS600-230-40
250 mm	164,59	1	NS600-250-40
300 mm	321,88	1	NS600-300-50

BAM/ZBF/002/21

Cuña anti chispa, CU-BE



NSB600

L	€		
80 mm	13,34	1	NSB600-80-13
100 mm	49,38	1	NSB600-100-50
135 mm	93,82	1	NSB600-135-50
150 mm	44,45	1	NSB600-150-25
150 mm	47,27	1	NSB600-150-30
150 mm	51,09	1	NSB600-150-40
150 mm	83,95	1	NSB600-150-50
180 mm	38,11	1	NSB600-180-13
180 mm	56,78	1	NSB600-180-32
180 mm	125,92	1	NSB600-180-50
200 mm	111,11	1	NSB600-200-20
200 mm	135,79	1	NSB600-200-30
200 mm	211,26	1	NSB600-200-40
200 mm	99,02	1	NSB600-200-50
230 mm	143,20	1	NSB600-230-40
250 mm	222,20	1	NSB600-250-40
300 mm	434,54	1	NSB600-300-50

BAM/ZBF/003/21

Palanca anti chispa, AL-BR



NS602

Ø	L	€		
16 mm	460 mm	148,04	1	NS602-460
20 mm	600 mm	203,95	1	NS602-600
22 mm	760 mm	313,26	1	NS602-760
22 mm	935 mm	364,01	1	NS602-900

BAM/ZBF/002/21

Cinzel anti chispa, CU-BE



NSB604

L	€		
140 mm	128,70	1	NSB604-150
200 mm	172,62	1	NSB604-200
300 mm	343,17	1	NSB604-300

BAM/ZBF/003/21

Granete mango moleteado anti chispa, AL-BR



NS608

L	€		
100 mm	33,84	1	NS608-100

BAM/ZBF/002/21

Palanca anti chispa, CU-BE



NSB6028

Ø	L	€		
16 mm	460 mm	299,78	1	NSB602-460
20 mm	600 mm	136,94	1	NSB602-600
22 mm	760 mm	621,79	1	NSB602-760
22 mm	920 mm	737,13	1	NSB602-900

BAM/ZBF/003/21

Cortafrios anti chispa AL-BR



NS606

L	€		
150 mm	55,26	1	NS606-150
200 mm	71,05	1	NS606-200
250 mm	96,05	1	NS606-250
300 mm	114,45	1	NS606-300
400 mm	147,37	1	NS606-400

BAM/ZBF/002/21

Granete anti chispa, CU-BE



NSB608

L	€		
100 mm	68,61	1	NSB608-100

BAM/ZBF/003/21

Buril anti chispa AL-BR



NS604

L	€		
140 mm	101,08	1	NS604-150
200 mm	162,15	1	NS604-200
300 mm	265,23	1	NS604-300

BAM/ZBF/002/21

Cinzel plano anti chispa, CU-BE



NSB606

L	€		
150 mm	87,03	1	NSB606-150
200 mm	111,91	1	NSB606-200
250 mm	151,28	1	NSB606-250
300 mm	205,17	1	NSB606-300
400 mm	264,11	1	NSB606-400

BAM/ZBF/003/21

RASQUETAS

Rasqueta en ángulo anti chispa, AL-BR



NS700

L	€		
45 mm	300 mm	63,47	1 NS700-300

BAM/ZBF/002/21



Rasqueta en ángulo anti chispa, CU-BE



NSB700

		€		
45 mm	310 mm	175,31	1	NSB700-300

BAM/ZBF/003/21

Rasqueta hojas largas anti chispa, AL-BR



NS704

		€		
100 mm	720 mm	120,63	1	NS704-225

BAM/ZBF/002/21

Rasqueta flexible anti chispa, CU-BE



NSB706

		€		
50 mm	200 mm	120,18	1	NSB706-50
80 mm	200 mm	184,41	1	NSB706-80

BAM/ZBF/003/21

Rasqueta plana anti chispa AL-BR



NS702

		€		
30 mm	325 mm	54,20	1	NS702-200

BAM/ZBF/002/21

Rasqueta de hoja larga anti chispa, CU-BE



NSB704

		€		
100 mm	720 mm	189,99	1	NSB704-225

BAM/ZBF/003/21

Rasqueta triangular anti chispa, AL-BR



NS708

		€		
440 mm		163,88	1	NS708-360

BAM/ZBF/002/21

Rasqueta plana anti chispa, CU-BE



NSB702

		€		
30 mm	325 mm	85,37	1	NSB702-200

BAM/ZBF/003/21

Rasqueta flexible anti chispa, AL-BR



NS706

		€		
50 mm	200 mm	76,30	1	NS706-50
80 mm	200 mm	117,09	1	NS706-80

BAM/ZBF/002/21

Rasqueta triangular anti chispa, CU-BE



NSB708

		€		
450 mm		222,15	1	NSB708-360

BAM/ZBF/003/21

Rasqueta triangular anti chispa, AL-BR



NS710

L	€		
470 mm	348,50	1	NS710-450

BAM/ZBF/002/21

Rasqueta triangular anti chispa, CU-BE



NSB710

L	€		
470 mm	472,36	1	NSB710-450

BAM/ZBF/003/21

HERRAMIENTAS DE JARDINERÍA

Pico anti chispa, AL-BR



NS800

L	€		
910 mm	167,93	1	NS800-1100
910 mm	245,50	1	NS800-1700
965 mm	292,94	1	NS800-2000

BAM/ZBF/002/21

Pico anti chispa, CU-BE



NSB800

L	g	€		
910 mm	2000 g	273,93	1	NSB800-1100
910 mm	2800 g	400,46	1	NSB800-1700
910 mm	3200 g	477,86	1	NSB800-2000

BAM/ZBF/003/21

Pala de punta redonda anti chispa, AL-BR



NS802

L	€		
1370 mm	223,13	1	NS802-290

BAM/ZBF/002/21

Pala redonda anti chispa, CU-BE



NSB802

L	€		
1450 mm	426,73	1	NSB802-290

BAM/ZBF/003/21

Cepillo de mano anti chispa, AL-BR



NS804

L	€		
290 mm	49,81	1	NS804-290

BAM/ZBF/002/21

EXTRACTORES

Extractores reversibles con tres garras anti chispa, AL-BR



NS810

L	l	€		
50-100 mm	105 mm	1.059,01	1	NS810-100
60-150 mm	175 mm	1.175,67	1	NS810-150
70-200 mm	250 mm	1.256,16	1	NS810-200
80-350 mm	320 mm	1.882,02	1	NS810-350

BAM/ZBF/002/21

Extractores reversibles con tres garras anti chispa, CU-BE



NSB810

L	l	€		
50-100 mm	105 mm	1.270,80	1	NSB810-100
60-150 mm	175 mm	1.410,80	1	NSB810-150
70-200 mm	250 mm	1.507,39	1	NSB810-200
80-350 mm	320 mm	2.540,71	1	NSB810-350

BAM/ZBF/003/21



LLAVES DINAMOMÉTRICAS ANTICHISPA

Llaves dinamo­métricas de disparo mecánico ajustable antichispa con visor de escala y cabeza fija de carraca de cobre al berilio

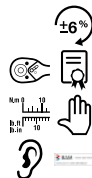

NS041

		€		
1/4"	5-25 N·m	1.516,07	1	NS041-8-25
3/8"	10-50 N·m	2.040,81	1	NS041-12-50
1/2"	20-100 N·m	2.320,37	1	NS041-16-100
1/2"	40-200 N·m	2.523,90	1	NS041-16-200
1/2"	60-260 N·m	2.722,94	1	NS041-16-260
3/4"	150-670 N·m	8.092,78	1	NS041-24-670
1"	200-900 N·m	9.192,02	1	NS041-32-900

BAM/ZBF/002/21

Llaves dinamo­métricas de disparo mecánico ajustable antichispa con visor de escala y cabeza fija de carraca de bronce de aluminio



NSB041

		€		
1/4"	5-25 N·m	2.607,76	1	NSB041-8-25
3/8"	10-50 N·m	2.979,02	1	NSB041-12-50
1/2"	20-100 N·m	3.444,21	1	NSB041-16-100
1/2"	40-200 N·m	3.693,59	1	NSB041-16-200
1/2"	60-260 N·m	3.942,95	1	NSB041-16-260
3/4"	150-670 N·m	12.254,91	1	NSB041-24-670
1"	200-900 N·m	14.454,50	1	NSB041-32-900

BAM/ZBF/003/21



Herramientas de acero inoxidable



LLAVES ACERO INOXIDABLE

Llave ajustable moleta central de acero inoxidable



SS001

L	g	€	SS
100mm/4"	13 mm	90,91	1 SS001-100
150mm/6"	18 mm	102,46	1 SS001-150
200mm/8"	24 mm	149,23	1 SS001-200
250mm/10"	30 mm	184,27	1 SS001-250
300mm/12"	36 mm	243,99	1 SS001-300
375mm/15"	46 mm	378,88	1 SS001-375
450mm/18"	55 mm	447,81	1 SS001-450
600mm/24"	60 mm	750,62	1 SS001-600

LLAVES COMBINADAS DE ACERO INOXIDABLE, mm



SS002

L	g	€	SS
7 in		19,06	1 SS002-7
6 mm		13,02	1 SS002-6
8 mm		16,38	1 SS002-8
10 mm		20,34	1 SS002-10
11 mm		22,72	1 SS002-11
12 mm		23,92	1 SS002-12
13 mm		25,11	1 SS002-13
14 mm		26,31	1 SS002-14
15 mm		27,51	1 SS002-15
16 mm		28,71	1 SS002-16
17 mm		29,90	1 SS002-17
19 mm		31,10	1 SS002-19
21 mm		38,75	1 SS002-21
22 mm		41,85	1 SS002-22
24 mm		47,12	1 SS002-24
27 mm		68,18	1 SS002-27
32 mm		93,17	1 SS002-32

Juego de 6 llaves combinadas de acero inoxidable, mm



SS002-6-2

L	g	€	SS
6	710 g	155,50	1 SS002-6-2

SS002-8, SS002-10, SS002-12, SS002-14, SS002-17, SS002-19

Set de 9 llaves combinadas de acero inoxidable, mm



SS002-9-2

L	g	€	SS
9	924 g	229,66	1 SS002-9-2

SS002-8, SS002-10, SS002-11, SS002-12, SS002-13, SS002-14, SS002-15, SS002-17, SS002-19

Llave combinada acero inoxidable, pulgadas



SS003

L	g	€	SS
1/4 in	105 mm	16,74	1 SS003-8
5/16 in	120 mm	18,19	1 SS003-10
11/32 in	135 mm	21,29	1 SS003-11
3/8 in	135 mm	23,33	1 SS003-12
7/16 in	150 mm	25,11	1 SS003-14
1/2 in	175 mm	27,51	1 SS003-16
9/16 in	175 mm	29,42	1 SS003-18
5/8 in	195 mm	31,10	1 SS003-20
11/16 in	195 mm	32,53	1 SS003-22

L	g	€	SS
3/4 in	215 mm	34,09	1 SS003-24
25/32 in	215 mm	40,66	1 SS003-25
13/16 in	245 mm	43,07	1 SS003-26
7/8 in	245 mm	44,25	1 SS003-28
15/16 in	265 mm	52,63	1 SS003-30

Llave de estrella acodada de acero inoxidable, mm



SS011

L	g	€	SS
5.5*7 mm	180 mm	26,99	1 SS011-0507
6*7 mm	180 mm	27,60	1 SS011-0607
8*9 mm	190 mm	28,36	1 SS011-0809
8*10 mm	190 mm	28,64	1 SS011-0810
9*11 mm	215 mm	30,41	1 SS011-0911
10*12 mm	215 mm	30,89	1 SS011-1012
12*14 mm	225 mm	33,74	1 SS011-1214
14*17 mm	255 mm	39,00	1 SS011-1417
16*18 mm	280 mm	43,76	1 SS011-1618
17*19 mm	280 mm	47,86	1 SS011-1719
17*22 mm	300 mm	63,68	1 SS011-1722
22*24 mm	330 mm	72,95	1 SS011-2224
24*27 mm	340 mm	92,64	1 SS011-2427
24*30 mm	350 mm	131,77	1 SS011-2430
30*32 mm	370 mm	159,59	1 SS011-3032

Set de llaves de estrella acodadas de acero inoxidable, mm



SS011-9-3

L	g	€	SS
9	2470 g	614,76	1 SS011-9-3

SS011-0810, SS011-1012, SS011-1214, SS011-1417, SS011-1719, SS011-1722, SS011-2224, SS011-2427, SS011-3032

Set de llaves de estrella acodadas de acero inoxidable, mm



SS011-11-3

g	€	SS
3100 g	776,99	SS011-11-3

SS011-0810, SS011-0911, SS011-1012, SS011-1214, SS011-1417, SS011-1719, SS011-1722, SS011-2224, SS011-2427, SS011-2430, SS011-3032

LLAVES DE VASO Y CARRACAS ACERO INOXIDABLE

Vaso 1/4" hexagonal de acero inoxidable, en mm



SS210

Ø	L	€	SS
4 mm	25 mm	13,33	SS210-4
4.5 mm	25 mm	13,33	SS210-4.5
5 mm	25 mm	13,33	SS210-5
5.5 mm	25 mm	13,33	SS210-5.5
6 mm	25 mm	16,05	SS210-6
7 mm	25 mm	17,48	SS210-7
8 mm	25 mm	19,54	SS210-8
9 mm	25 mm	21,87	SS210-9
10 mm	25 mm	23,17	SS210-10
11 mm	25 mm	25,75	SS210-11
12 mm	26 mm	29,12	SS210-12
13 mm	26 mm	31,06	SS210-13
14 mm	26 mm	32,23	SS210-14

Vaso 1/2" hexagonal de acero inoxidable, en mm



SS220

Ø	L	€	SS
8 mm	40 mm	33,01	SS220-8
9 mm	40 mm	34,29	SS220-9
10 mm	40 mm	35,59	SS220-10

Ø	L	€	SS
11 mm	40 mm	37,53	SS220-11
12 mm	40 mm	40,12	SS220-12
13 mm	40 mm	41,41	SS220-13
14 mm	40 mm	43,36	SS220-14
15 mm	40 mm	46,59	SS220-15
16 mm	40 mm	48,54	SS220-16
17 mm	40 mm	50,47	SS220-17
18 mm	42 mm	53,06	SS220-18
19 mm	42 mm	55,65	SS220-19
20 mm	42 mm	58,24	SS220-20
21 mm	43 mm	59,54	SS220-21
22 mm	43 mm	60,82	SS220-22
23 mm	43 mm	66,00	SS220-23
24 mm	43 mm	69,89	SS220-24
25 mm	43 mm	73,77	SS220-25
26 mm	43 mm	84,12	SS220-26
27 mm	46 mm	86,71	SS220-27
28 mm	46 mm	93,18	SS220-28
29 mm	46 mm	97,06	SS220-29
30 mm	46 mm	102,25	SS220-30
31 mm	46 mm	112,59	SS220-31
32 mm	46 mm	112,59	SS220-32

Vaso 3/4" hexagonal de acero inoxidable, en mm



SS224

Ø	L	€	SS
17 mm	50 mm	72,47	SS224-17
19 mm	50 mm	75,07	SS224-19
22 mm	55 mm	81,53	SS224-22
24 mm	55 mm	91,88	SS224-24
27 mm	55 mm	97,06	SS224-27
30 mm	60 mm	112,59	SS224-30
32 mm	60 mm	128,13	SS224-32
34 mm	60 mm	141,07	SS224-34
36 mm	60 mm	148,84	SS224-36
41 mm	65 mm	174,72	SS224-41
46 mm	65 mm	207,07	SS224-46
50 mm	70 mm	231,66	SS224-50
55 mm	75 mm	330,02	SS224-55
60 mm	75 mm	386,96	SS224-60
65 mm	80 mm	491,79	SS224-65

Extensión de acero inoxidable



SS234

Ø	L	€	SS
100 mm	1/2"	51,77	SS234-16-100
200 mm	1/2"	84,12	SS234-16-200
250 mm	1/2"	97,06	SS234-16-250

L	Ø	€	SS
100 mm	3/4"	112,59	SS234-24-100
200 mm	3/4"	122,94	SS234-24-200
250 mm	3/4"	169,20	SS234-24-250

Junta universal de acero inoxidable



SS236

L	Ø	€	SS
56 mm	1/4"	61,78	SS236-08-80
80 mm	1/2"	84,12	SS236-16-80
110 mm	3/4"	148,84	SS236-24-110

Mango corregido en T de acero inoxidable



SS238

L	Ø	€	SS
250 mm	1/4"	113,89	SS238-08-250
250 mm	1/2"	115,18	SS238-16-250
350 mm	3/4"	161,77	SS238-24-350

Berbiquí de acero inoxidable



SS243

L	Ø	€	SS
300 mm	1/4"	54,97	SS243-08
390 mm	1/2"	128,86	SS243-16
450 mm	3/4"	326,50	SS243-24



Carraca de acero inoxidable



SS242

L	mm	€	Paquete	Artículo
200 mm	1/4"	148,84	1	SS242-08-200
245 mm	1/2"	155,30	1	SS242-16-245
320 mm	3/4"	304,14	1	SS242-24-320

DESTORNILLADORES DE ACERO INOXIDABLE

Destornillador de acero inoxidable ERGO™



BE-8020i - BE-8252i

Tip	L	€	Paquete	Artículo
3.0 mm	60 mm	6,69	5	BE-8020I
3.5 mm	75 mm	7,21	5	BE-8030I
4.0 mm	100 mm	8,26	5	BE-8040I
5.5 mm	125 mm	10,50	5	BE-8241I
6.5 mm	150 mm	14,61	5	BE-8252I

Destornillador de acero inoxidable ERGO™



BE-8600i - BE-8623i

Tip	L	€	Paquete	Artículo
PH 0	60 mm	8,10	5	BE-8600I
PH 1	75 mm	10,03	5	BE-8610I
PH 2	100 mm	14,07	5	BE-8620I
PH 3	150 mm	21,27	5	BE-8623I

Destornilladores ERGO™ de acero inoxidable



BE-8800i - BE-8823i

Tip	L	€	Paquete	Artículo
PZ 0	60 mm	10,00	5	BE-8800I
PZ 1	75 mm	11,59	5	BE-8810I
PZ 2	100 mm	15,29	5	BE-8820I
PZ 3	150 mm	22,35	5	BE-8823I

Destornillador de acero inoxidable ERGO™



BE-8910i - BE-8925i

Tip	L	€	Paquete	Artículo
T 10	75 mm	9,79	5	BE-8910I
T 15	100 mm	9,87	5	BE-8915I
T 20	100 mm	10,00	5	BE-8920I
T 25	125 mm	10,67	5	BE-8925I

Juego de 6 destornilladores ERGO™ de acero inoxidable



BE-9881i

Paquete	€	Paquete	Artículo
6	57,20	1	BE-9881I

BE-8020I, BE-8040I, BE-8241I, BE-8252I

BE-8610I, BE-8620I

Juego de 6 destornilladores ERGO™ inox.



BE-9882i

Paquete	€	Paquete	Artículo
6	59,69	1	BE-9882I

BE-8020I, BE-8040I, BE-8241I, BE-8252I

BE-8810I, BE-8820I

LLAVES ACODADAS

Llave L con bola de acero inoxidable, mm



SS324

Tip	L	€	Paquete	Artículo
1.5 mm	80 mm	4,21	2	SS324-1.5
2 mm	85 mm	4,21	2	SS324-2
2.5 mm	93 mm	4,21	2	SS324-2.5
3 mm	103 mm	4,52	1	SS324-3
4 mm	110 mm	4,95	1	SS324-4
5 mm	123 mm	6,03	1	SS324-5
6 mm	146 mm	6,68	1	SS324-6
8 mm	168 mm	10,44	1	SS324-8
10 mm	180 mm	12,91	1	SS324-10

Juego de 9 llaves hexagonales con bola inoxidables, serie larga



BE-9770i

Paquete	€	Paquete	Artículo
9	33,68	20	BE-9770I

SS324-1.5, SS324-2, SS324-2.5,
SS324-3, SS324-4, SS324-5, SS324-6,
SS324-8, SS324-10

Llave hexagonal en L con bola, en
pulgadas



SS325

Ø	L	€	Paquete	Material
5/64" in	85 mm	5,39	2	SS325-2.5
7/64" in	96 mm	7,18	2	SS325-3.5
1/8" in	101 mm	5,92	1	SS325-4
9/64" in	106 mm	9,57	1	SS325-4.5
5/32" in	111 mm	6,46	1	SS325-5
3/16" in	121 mm	8,61	1	SS325-6
7/32" in	132 mm	9,16	1	SS325-7
1/4" in	142 mm	9,69	1	SS325-8
5/16" in	163 mm	11,31	1	SS325-10
3/8" in	183 mm	13,99	1	SS325-12
3/32" in	90 mm	5,39	2	SS325-3

Juego de 13 llaves hexagonales inox. con
bola serie larga, pulgadas



BE-9786i

Ø	€	Paquete	Material
0.05; 1/16; 5/64; 3/32; 7/64; 1/8; 9/64; 5/32; 3/16; 7/32; 1/4; 5/16; 3/8; in	41,86	1	BE-9786i

SS325-2.5, SS325-3, SS325-3.5,
SS325-4, SS325-4.5, SS325-5, SS325-
6, SS325-7, SS325-8, SS325-10,
SS325-12

PUNTAS ACERO INOXIDABLE

Punta Phillips de acero inoxidable para
destornilladores de torsión - 25 mm



65I/PH

Paquete	Material	€	Paquete	Material
10	1	28,05	1	65I/PH1
2	1	6,62	1	65I/PH1-2P
10	2	28,05	1	65I/PH2
2	2	6,62	1	65I/PH2-2P
10	3	28,05	1	65I/PH3
2	3	6,62	1	65I/PH3-2P

Punta Pozidriv de acero inoxidable para
destornilladores de torsión - 25 mm



65I/PZ

Paquete	Material	€	Paquete	Material
10	1	28,05	1	65I/PZ1
2	1	6,62	1	65I/PZ1-2P
10	2	28,05	1	65I/PZ2
2	2	6,62	1	65I/PZ2-2P
10	3	28,05	1	65I/PZ3
2	3	6,62	1	65I/PZ3-2P

Punta de torsión de acero inoxidable Torx®
- 25 mm



65I/T

Paquete	Material	€	Paquete	Material
5	T15	16,04	1	65I/T15
5	T25	15,27	1	65I/T25
5	T30	15,27	1	65I/T30
5	T40	16,04	1	65I/T40
2	T40	7,29	1	65I/T40-2P

Caja 5 Adaptadores universales de acero
inoxidable de 1/4"



KSR753

Paquete	Material	€	Paquete	Material
1	1/4 in	21,92	1	KSR753-1P
5	1/4 in	99,03	1	KSR753

-1P: Envase unitario soporte plástico

Juego 6 puntas de acero inoxidable
Phillips, Pozidriv,



65I/7

Paquete	Material	€	Paquete	Material
22 x 65 x 75 mm		26,36	1	65I/7-1

65I/PH2

65I/PZ2

65I/T15, 65I/T20, 65I/T25, 65I/T30

ALICATES ACERO INOXIDABLE

Alicate universal de acero inoxidable



SS400

Paquete	Material	€	Paquete	Material
155 mm		59,93	1	SS400-160
175 mm		75,07	1	SS400-180
200 mm		95,77	1	SS400-200



Alicate de corte diagonal de acero inoxidable



SS402

↔ L	€		
150 mm	64,32	1	SS402-160
195 mm	70,02	1	SS402-200

Tenacilla articulada de acero inoxidable



SS410

↔ L	€		
250 mm	99,65	1	SS410-250
300 mm	155,30	1	SS410-300

Maza de acero inoxidable



SS502

↔ L	€		
1000 g	110,01	1	SS502-1000-FB
1500 g	155,30	1	SS502-1500-FB
2000 g	199,31	1	SS502-2000-FB
2500 g	251,07	1	SS502-2500-FB
3000 g	297,66	1	SS502-3000-FB
3600 g	355,90	1	SS502-3600-FB

Alicate dos posiciones de acero inoxidable



SS412

↔ L	€		
200 mm	97,06	1	SS412-200

Mordaza de acero inoxidable



SS415

↔ L	€		
255 mm	148,84	1	SS415-225

CINCELES Y PUNTEROS DE CHAPISTA

Palanca de acero inoxidable



SS603

↔ L	€		
500 mm	80,24	1	SS603-15-500
500 mm	111,30	1	SS603-19-500
500 mm	114,42	1	SS603-20-500
500 mm	134,66	1	SS603-23-500
800 mm	207,07	1	SS603-23-800
600 mm	195,57	1	SS603-25-600
1000 mm	452,96	1	SS603-30-1000

MARTILLOS DE ACERO INOXIDABLE

Martillo con bola de acero inoxidable



SS506

↔ L	€		
200 g	37,53	1	SS506-200-FB
300 g	50,47	1	SS506-300-FB
450 g	54,36	1	SS506-500-FB
680 g	97,06	1	SS506-700-FB
900 g	112,59	1	SS506-900-FB
1100 g	128,13	1	SS506-1100-FB

Cinzel plano de acero inoxidable



SS610

↔ L	€		
160 mm	38,83	1	SS610-16-160
200 mm	56,30	1	SS610-18-200
300 mm	176,01	1	SS610-24-300
400 mm	275,66	1	SS610-25-400
500 mm	372,73	1	SS610-30-500

Alicates de punta semirredonda de acero inoxidable



SS406

↔ L	€		
150 mm	64,71	1	SS406-160
175 mm	74,68	1	SS406-200

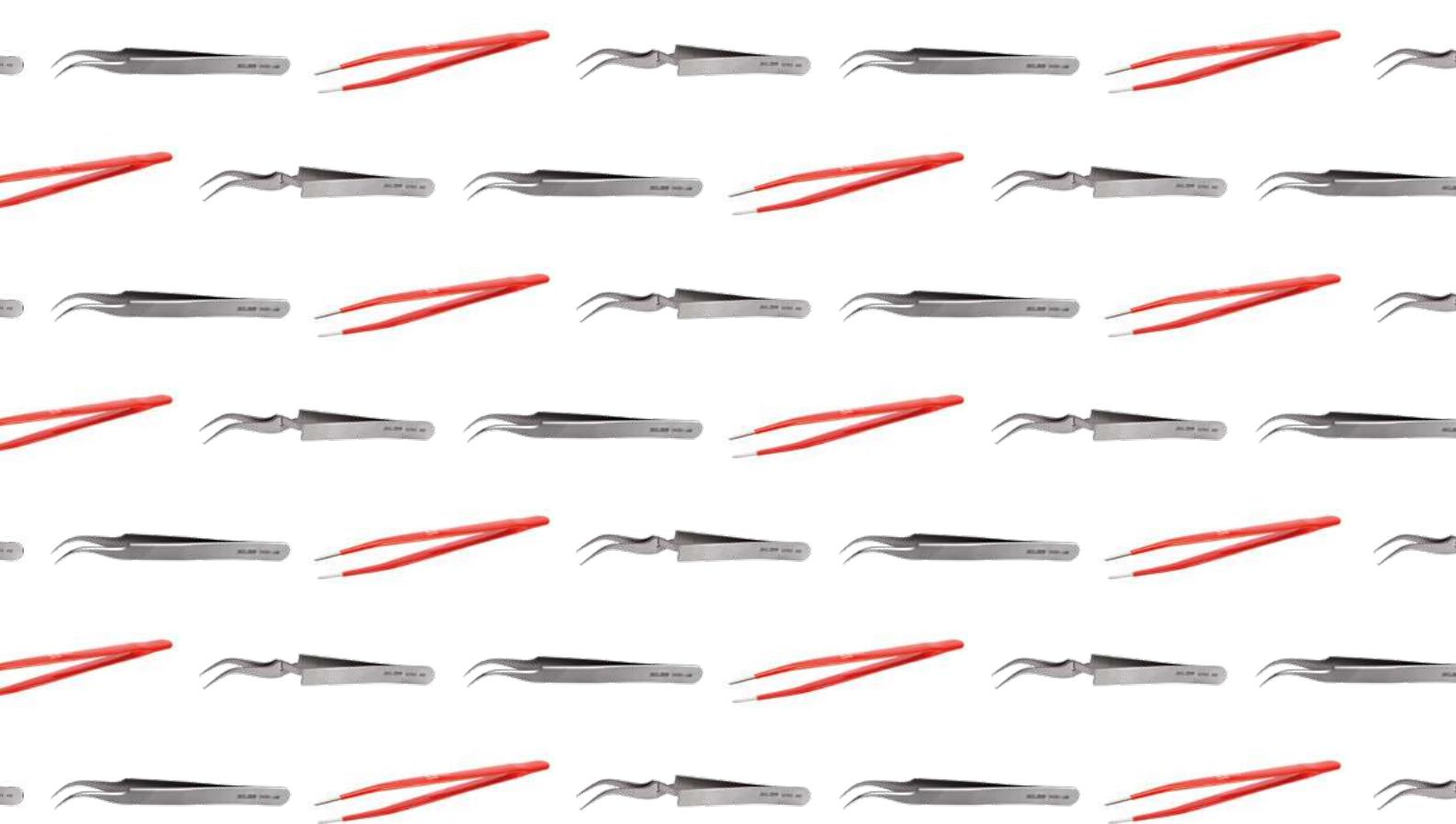

Pinzas y herramientas especiales para electrónica



PINZAS ELECTRONICA

Pinza universal



5468

L	€		
112 mm	26,06	5	5468-112

Pinza universal



5469

L	€		
127 mm	25,32	5	5469-127
127 mm	39,43	5	5469 R
127 mm	28,45	5	5469 I

Pinza universal



5469B

L	€		
120 mm	24,46	5	5469 B
120 mm	26,18	5	5469 BI

Pinza de punta puntiaguda



5479

L	€		
130 mm	18,88	5	5479-130

Pinza universal



5471F

L	€		
120 mm	20,91	5	5471 F-120
145 mm	22,66	5	5471 F-145
200 mm	46,01	5	5471 F-200
250 mm	58,83	5	5471 F-250
300 mm	80,87	5	5471 F-300
120 mm	22,02	5	5471 FI-120
200 mm	44,29	5	5471 FI-200
120 mm	36,01	5	5471 FR-120
145 mm	40,85	5	5471 FR-145

Pinza College



5475R/5475K

L	€		
150 mm	49,47	5	5475 R
100 mm	27,25	5	5475 K

Pinza College



5516

L	€		
150 mm	24,03	5	5516
150 mm	26,36	5	5516 I

Pinza anti-magnética



5465AMT

L	€		
110 mm	56,96	5	5465 AMT

Pinza de punta puntiaguda



5517

L	€		
155 mm	27,78	5	5517
155 mm	27,23	5	5517 I

Pinza con puntas en cruz



5518

L	€		
155 mm	30,35	5	5518

Pinza SDM para electrónica



5540AM

L	€		
120 mm	41,77	5	5540 AM

Pinza SDM para electrónica



5541AM

	€		
120 mm	41,77	5	5541 AM

Pinza SDM para electrónica



5547AM

	€		
120 mm	41,77	5	5547 AM

Pinza para electrónica



5490AM

	€		
115 mm	41,77	5	5490 AM

Pinza SDM para electrónica



5544AM

	€		
115 mm	41,77	5	5544 AM

Pinza SDM para electrónica



5549AM

	€		
120 mm	41,77	5	5549 AM

Pinza de engastar



5573

	€		
145 mm	63,67	5	5573-145

Pinza SDM para electrónica



5545AM

	€		
120 mm	41,77	5	5545 AM

Pinza para electrónica



5488AM

	€		
115 mm	41,77	5	5488 AM

Pinza de engastar



5578

	€		
122 mm	45,20	5	5578-115

Pinza SDM para electrónica



5546AM

	€		
120 mm	41,77	5	5546 AM

Pinza para electrónica



5489AM

	€		
115 mm	41,77	5	5489 AM

Pinza de engastar



5579

	€		
115 mm	45,20	5	5579-115



Pinza SDM para electrónica



5588AM

	€		
120 mm	41,77	5	5588 AM

Pinza SDM para electrónica



5589AM

	€		
120 mm	41,77	5	5589 AM

Pinza SDM para electrónica



5590AM

	€		
120 mm	41,77	5	5590 AM

Juego de pinzas SDM para electrónica



5568/5

	€		
100 g	222,68	1	5568/5

- 5489 AM
- 5583 AM
- 5589 AM
- 5584 AM
- 5546 AM

Pinza de relojero



5463

	€		
120 mm	34,03	5	5463-120
120 mm	56,96	5	5463 R

Pinza de joyero



5470

	€		
120 mm	21,66	5	5470-120

Pinza con absorción de calor



5577

	€		
145 mm	64,38	5	5577-145

Pinza de relojero



5465

	€		
105 mm	54,08	5	5465 R

Pinza cortante para electrónica



5493

	€		
115 mm	66,50	5	5493-115

Pinza para soldar



5476H

	€		
160 mm	63,96	5	5476 H

HERRAMIENTAS DE SOLDADURA

Soldadora



3250

W	°C	€		
100 W	400 °C	83,42	1	325001000
		4,68	1	3250010SH

Punta recambio: 3250010SH

Soldadora para trabajos de industria pesada



322500

W	°C	€		
30 W	370 °C	44,04	1	322500300
40 W	375 °C	46,67	1	322500500
80 W	380 °C	49,64	1	322500800

Soldador eléctrico, ligero y compacto



32600

W	°C	€		
18 W	390 °C	51,25	1	326000200
25 W	420 °C	55,58	1	326000300

Soldador con control de temperatura



3270

W	°C	€		
50 W	200-500 °C	105,91	1	327020500

Puntas de repuesto para soldadora



3225

mm	€		
1.5 x 2.5 mm	8,61	1	322510300
1.5 x 2.5 mm	8,61	1	322510400
2 x 3 mm	8,61	1	322510500
2 x 3 mm	8,61	1	322510600
2.5 x 5 mm	8,61	1	322510700
2.5 x 5 mm	8,61	1	322510800

Puntas de repuesto para soldadora



326010

g	€		
5 g	7,49	1	326010200
5 g	7,55	1	326020200
5 g	7,55	1	326030200

Puntas de repuesto para soldador 3270



327020500-SH

mm	€		
0,5mm	8,02	1	327020500-SH1
2mm	8,02	1	327020500-SH2
3mm	8,02	1	327020500-SH3
4mm	8,02	1	327020500-SH4

Soldadura libre de plomo (Sn)



3290

mm	€		
2000 mm	4,52	1	329000330
4000 mm	5,58	1	329000500

HERRAMIENTAS PARA MECÁNICA DE PRECISIÓN

Punzones en miniatura, ganchos y picos



2633/

mm	€		
17 x 80 x 150 mm	25,87	12	2633/S4
12 x 12 x 275 mm	26,36	12	2633L/S4



Gancho doble para hilos y muelles



5418

	€		
145 mm	46,79	1	5418

Juego de ganchos para hilos y muelles



5419/6T

	€		
5 x 78 x 110 mm	54,70	1	5419/6T

Tenedor para desoldar



ergo



BE-3529

	€		
197 mm	18,90	5	BE-3529

Destornillador de ajuste con guía



5550

	€		
140 mm	18,76	10	5550-3.2
140 mm	21,13	10	5550-4.5

Útiles de sintonización



5551-5554

	€		
220 mm	19,62	1	5551
205 mm	19,62	1	5552
195 mm	19,62	1	5553
180 mm	19,62	1	5554

Juego de útiles de sintonización



5600/4

	€		
75 g	91,66	1	5600/4

5551, 5552, 5553, 5554

Pinza pelacables lacada



2530-32/2530-40

	€		
130 mm	46,82	5	2530-40

Rasqueta de acero al carbono



2487

	€		
210 mm	17,36	12	2487

Rasqueta triangular



3524

	€		
24 g	34,88	1	3524
5 g	16,75	1	3524-L-K

Rasqueta triangular



3525HB

	€		
168 mm	27,03	5	3525HB



Medición y trazado



FLEXÓMETROS Y CINTAS MÉTRICAS

Flexómetro



MTS

L	mm	€	Icon	Icon	Model
5 m	25 mm	32,49	6		MTS-5-25
5 m	25 mm	32,49	6		MTS-5-25-E
8 m	25 mm	40,13	6		MTS-8-25
8 m	25 mm	40,13	6		MTS-8-25-E

Flexómetro Bimaterial



MTB

L	mm	€	Icon	Icon	Model
3 m	16 mm	11,76	6		MTB-3-16
3 m	16 mm	13,41	6		MTB-3-16-M
3 m	16 mm	13,41	6		MTB-3-16-M-E
5 m	25 mm	24,03	6		MTB-5-25
5 m	25 mm	25,71	6		MTB-5-25-M
5 m	25 mm	25,71	6		MTB-5-25-M-E
8 m	25 mm	36,58	6		MTB-8-25
8 m	25 mm	39,01	6		MTB-8-25-M
8 m	25 mm	39,01	6		MTB-8-25-M-E

M: Punta magnética E: Pulgadas

Flexómetro clase I



MTB C1

L	mm	€	Icon	Icon	Model
5 m	25 mm	35,59	6		MTB-5-25-C1

Flexómetro



MTG

L	mm	€	Icon	Icon	Model
3 m	16 mm	5,26	12		MTG-3-16
3 m	16 mm	5,26	12		MTG-3-16-E
5 m	19 mm	8,28	12		MTG-5-19
5 m	19 mm	8,28	12		MTG-5-19-E
8 m	25 mm	10,53	4		MTG-8-25
8 m	25 mm	10,53	4		MTG-8-25-E

E: Pulgadas

Flexómetro compacto Clase medición I



MTC C1

L	mm	€	Icon	Icon	Model
3 m	13 mm	11,34	6		MTC-3-13-C1
5 m	16 mm	12,71	6		MTC-5-16-C1

Flexómetro compacto clase II



MTC C2

L	mm	€	Icon	Icon	Model
3 m	13 mm	8,15	6		MTC-3-13
5 m	16 mm	9,93	6		MTC-5-16

Flexómetro compacto de 3m



MT-TS-3

L	mm	€	Icon	Icon	Model
3 m	13 mm	9,85	12		MT-TS-3

Flexómetro



1162N

L	mm	€	Icon	Icon	Model
3 m	13 mm	23,36	1		1162N-1/2

Cinta métrica de acero con adhesivo



BT

L	mm	€	Icon	Icon	Model
3 m	13 mm	7,25	12		BTR-3-13
6 m	13 mm	9,26	12		BTR-6-13
3 m	13 mm	7,25	12		BTL-3-13
6 m	13 mm	9,26	12		BTL-6-13

Cinta métrica



LTG

L	T	€	Box	Icon
10 m	10 mm	16,70	6	LTG-10
20 m	10 mm	22,38	6	LTG-20
30 m	10 mm	26,83	6	LTG-30

Cinta métrica



LTB

L	T	€	Box	Icon
10 m	13 mm	19,94	6	LTB-10
20 m	13 mm	22,62	6	LTB-20
30 m	13 mm	29,24	6	LTB-30

Cinta métrica larga



LT-STEEL

L	T	€	Box	Icon
30 m	13 mm	67,31	5	LT-STEEL-30
50 m	13 mm	105,38	5	LT-STEEL-50

Cinta métrica



LTS

L	T	€	Box	Icon
30 m	13 mm	28,27	5	LTS-30
30 m	13 mm	28,27	5	LTS-30-E
50 m	13 mm	38,96	5	LTS-50
50 m	13 mm	38,96	5	LTS-50-E
100 m	13 mm	82,18	5	LTS-100
100 m	13 mm	82,18	5	LTS-100-E

RUEDAS DE MEDICIÓN

Rueda de medición, 150 mm



MW-150

L	€	Box	Icon
150 mm	76,06	2	MW-150

Rueda de medición, 250 mm



MW-250

L	€	Box	Icon
940 mm	136,43	2	MW-250

NIVELES

Nivel aluminio con asas



466

L	€	Box	Icon
400 mm	32,59	4	466-400
400 mm	40,96	4	466-400-M
600 mm	39,67	4	466-600
600 mm	48,12	4	466-600-M
800 mm	43,03	4	466-800
800 mm	52,00	4	466-800-M
1000 mm	48,11	4	466-1000
1000 mm	59,61	4	466-1000-M
1200 mm	58,24	4	466-1200
1200 mm	70,94	4	466-1200-M
1800 mm	75,11	4	466-1800
2000 mm	91,62	4	466-2000

Precisión +/-0,5mm

Nivel



426

L	T	€	Box	Icon
400 mm	49x22 mm	31,61	1	426-400
600 mm	49x22 mm	35,65	1	426-600
800 mm	49x22 mm	39,82	1	426-800
1000 mm	49x22 mm	47,26	1	426-1000
1200 mm	49x22 mm	55,59	1	426-1200



Nivel



416

	€		
400 mm	15,97	10	416-400
600 mm	18,73	10	416-600
800 mm	21,60	10	416-800
1000 mm	26,69	10	416-1000
1200 mm	30,26	10	416-1200
1500 mm	34,20	10	416-1500
1800 mm	39,77	10	416-1800
2000 mm	47,38	10	416-2000

Nivel trapezoidal, aluminio inyectado



405

	€		
400 mm	29,76	5	405-400
600 mm	35,59	5	405-600
800 mm	45,29	10	405-800
1000 mm	60,82	5	405-1000

Nivel magnético trapezoidal, aluminio inyectado



405_M

	€		
400 mm	33,53	5	405-400-M
600 mm	39,47	5	405-600-M
800 mm	49,06	5	405-800-M
1000 mm	64,59	5	405-1000-M

Nivel ligero trapezoidal, aluminio inyectado



405L

	€		
400 mm	27,18	10	405L-400
600 mm	33,01	10	405L-600

Nivel magnético ligero trapezoidal, aluminio inyectado



405L_M

	€		
400 mm	30,41	5	405L-400-M
600 mm	36,89	5	405L-600-M

Nivel de aluminio inyectado



406

	€		
300 mm	35,56	1	406-300
400 mm	40,29	5	406-400
500 mm	48,61	5	406-500
600 mm	47,65	5	406-600
800 mm	56,36	5	406-800

Nivel magnético sólido, aluminio inyectado



406_M

		€		
300 mm	1	48,86	5	406-300-M
400 mm	1	53,72	5	406-400-M
500 mm	1	58,90	5	406-500-M
600 mm	1	57,74	5	406-600-M

Nivel de poliestireno



406P

	€		
400 mm	10,20	10	406P-400
600 mm	12,91	10	406P-600

416-SET-1 + Bolsa de transporte



416-SET+ BAG

	€		
3	101,07	1	416-SET+BAG

416-SET-1

4750-LV-1

BAHCO



Juego de 3 niveles



416-SET-1



€



3

68,26

5

416-SET-1

416-600, 416-1200, 416-1800



Juego de 3 niveles



416-SET-2



€



3

71,12

5

416-SET-2

416-600, 416-1200, 416-2000



Nivel magnético



406T-225



€



228 mm

6,80

10

406T-225

DISP es un display con 12 unidades

Nivel torpedo de aluminio



426TOR9



€



230 mm

23,03

10

426TOR9

Nivel de andamio



466-250



€



250 mm

29,24

10

466-250

Alineador base magnética



466-LINE



€



75 mm

5,34

12

466-LINE

Nivel dos posiciones



466-BE1



€



20 g

6,43

12

466-BE1

Nivelador de postes magnético



466-POST



€



120 x 75 x 80 mm

9,02

6

466-POST

Nivel



486



€



1800 mm

58,84

5

486-1800

2000 mm

64,52

5

486-2000

2400 mm

75,73

5

486-2400

Nivel



486-xxxWH



€



1800 mm

58,84

5

486-1800WH

2000 mm

64,52

5

486-2000WH

2400 mm

75,73

5

486-2400WH

Nivel de doble perfil



496



€



1500 mm

73,42

5

496-1500

1800 mm

85,67

5

496-1800



Vial de repuesto para nivel



496-SPARE

	€		
496-1500, 496-1800	7,46	1	496-SPARE

MARCADO

Plomada trazadora de magnesio rápida 5:1, 30 m



CL-1441

	€		
185 mm	24,27	36	CL-1441

Plomada trazadora de magnesio 1:1



CL-1331

	€		
185 mm	18,76	48	CL-1331

Plomada trazadora triple velocidad de rebobinado



CL-1221

	€		
130 mm	12,17	6	CL-1221

CL-Line: Línea de trazado de repuesto

Polvo colorante, 227 g



CHALK

	€		
227 g	3,09	6	CHALK-BLUE
227 g	3,28	6	CHALK-WHITE
227 g	3,09	6	CHALK-RED
227 g	3,09	6	CHALK-YELLOW

Juego de Plomada trazadora, Polvo colorante azul y Nivel de línea



CL-1221-SET

	€		
180 g	17,68	4	CL-1221-SET

CHALK-BLUE

466-LINE

CL-1221

Plomada metálica 5m de cuerda



PBS

	€		
5 m	24,63	6	PBS-700

Plomada de latón



PBB

		€		
185 mm	227 g	24,10	8	PBB-8

Lapiz Carpintero grado HB



P-HB

		€		
175 mm	25	0,77	25	P-HB

Código de Certificado FSC: QMI-COC-001417 Carpeta No.: 1627439

Display 200 lápices de carpintero



PENCIL-200

		€			
180 mm	200	181,35	1	PENCIL-200-DISP	

Portaminas de carpintero, dureza HB



P-MEC

		€			
150 mm	1	5,53	24	P-MEC	
100 mm	5	4,01	12	P-MEC-LEAD	

Punta de trazar con punta de recambio Carbide de 150 mm



1179-SCRIBE

	€			
150 mm	21,44	5	1179-SCRIBE	
	7,43	1	1179-TIPS	

Diam. Punta 2,5mm Diam. Cuerpo 8mm

Punta de trazar de carburo de tungsteno de 150 mm



1178-SCRIBE

	€			
150 mm	7,31	5	1178-SCRIBE	

Puntas de trazar acodadas, 230 mm



1177-SCRIBE

	€			
230 mm	6,53	5	1177-SCRIBE	

REGLAS

Metro plegable 1m de madera de abedul



WR1

		€			
1 m	17 mm	4,66	50	WR1	
1 m	17 mm	4,67	50	WR1-MM	

WR1: mm y pulg WR1-MM: Métrico

Metro plegable 2m de madera de abedul



WR2

		€			
2 m	17 mm	6,21	25	WR2	
2 m	17 mm	7,48	25	WR2-MM	

WR2:mm y pulg WR2-MM: Métrico

Metro 2m plegable 12 secciones mm



WR2-12

		€			
2 m	17 mm	6,21	25	WR2-12	

Regla flexible de acero inoxidable con clip bolsillo



1179-FLX

		€			
160 mm	12 mm	2,71	25	1179-FLX	

Regla de acero, mm



SR MM

		€			
150 mm	19 mm	2,07	12	SR150-MM	
200 mm	19 mm	2,71	12	SR200-MM	
300 mm	25 mm	3,64	12	SR300-MM	
600 mm	30 mm	7,12	20	SR600-MM	
1000 mm	35 mm	14,98	20	SR1000-MM	

Producto no disponible para España



Regla de acero, pulgadas



SR IN

L	Icon	€	Icon	Icon
6 in	6 in	2,07	12	SR150-E
8 in	8 in	2,71	12	SR200-E
12 in	12 in	3,64	12	SR300-E
24 in	24 in	7,12	20	SR600-E
39 in	40 in	14,98	20	SR1000-E

Escuadra de albañil

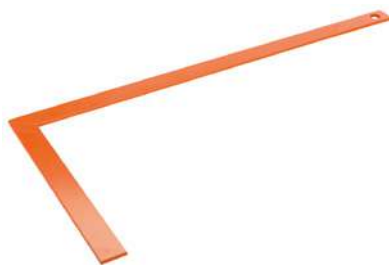

3085

L	Icon	€	Icon	Icon
400 mm	200 mm	19,08	1	308504000
500 mm	250 mm	20,94	1	308505000
600 mm	300 mm	24,19	1	308506000
800 mm	400 mm	29,43	1	308508000
1000 mm	500 mm	33,04	1	308510000

Escuadra ajustable



9572

L	Icon	€	Icon	Icon
235 mm	115 mm	25,52	20	9572-200
250 mm	150 mm	27,07	20	9572-250

ESCUADRAS

Escuadra



9045-B

L	Icon	€	Icon	Icon
220 mm	170 mm	25,55	6	9045-B-200
250 mm	170 mm	27,04	6	9045-B-250
300 mm	170 mm	29,49	6	9045-B-300
400 mm	170 mm	34,39	1	9045-B-400

Escuadra Combinada



CS

L	Icon	€	Icon	Icon
152 mm	90 mm	12,75	12	CS150
305 mm	125 mm	23,72	12	CS300
407 mm	125 mm	26,40	12	CS400

Escuadra



9574

L	Icon	€	Icon	Icon
215 mm	165 mm	20,86	10	9574-200
285 mm	170 mm	21,40	10	9574-250
300 mm	170 mm	22,65	10	9574-300

Escuadra



9048

L	Icon	€	Icon	Icon
200 mm	165 mm	20,53	10	9048-200
250 mm	165 mm	21,24	10	9048-250
300 mm	180 mm	24,26	10	9048-300
350 mm	180 mm	24,29	10	9048-350
400 mm	180 mm	25,71	10	9048-400

Kit de piezas de repuesto para los modelos CS de escuadras deslizantes, 4 piezas

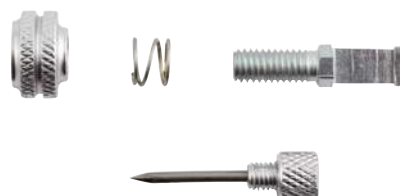

CS-SPARE

Icon	€	Icon	Icon
CS150, CS300, CS400	4,44	1	CS-SPARE

Escuadra fija



9575

L	Icon	€	Icon	Icon
250 mm	110 mm	31,63	6	9575-250

Escuadra de carpintero



FCS-600/FCS-1000

L	W	€	Q	Ref
600 mm	300 mm	21,69	6	FCS-600
800 mm	300 mm	23,04	6	FCS-800
1000 mm	360 mm	25,22	6	FCS-1000

Calibre pie de rey



1150

L	W	€	Q	Ref
150 mm	9 x 75 x 235 mm	59,27	1	1150-1/2H/P

Juego de 20 galgas de espesores



1547

Q	L	€	Q	Ref
20	100 mm	13,88	20	1547

Escuadra ajustable para yesista



AS-1200

L	W	€	Q	Ref
1265 mm	560 mm	65,94	3	AS-1200

Juego de 26 galgas de espesores

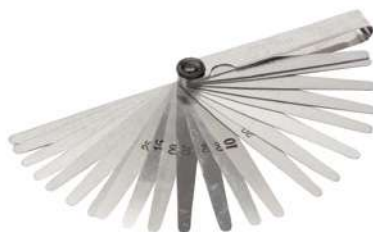

1544

Q	L	€	Q	Ref
26	100 mm	17,03	1	1544

0,03 mm to 0,1 mm in 0,01 mm increments / 0,10 mm to 1,0 mm in 0,05 mm increments

Galgas de roscas 24 hojas 60°



1535

Q	L	€	Q	Ref
24	67 mm	9,16	1	1535

MEDICIÓN DE PRECISIÓN

Calibre digital de acero inox



1150D

L	W	€	Q	Ref
150 mm	25 x 90 x 245 mm	72,09	1	1150D

Rango de 0 - 150 mm en incrementos de 0.01

Juego de 13 galgas de espesores



1546

L	€	Q	Ref
100 mm	10,09	1	1546

Galgas de roscas de 52 hojas métrico y whitworth 55°



1537

Q	L	€	Q	Ref
0.25-6.0 / 4-62	70 mm	14,37	1	1537





BAHCO



Herramientas para pared



RASCADORES

Rasqueta ergonómica con funda



ergo



625



€



25 mm

30,10

5

625

Hojas de repuesto para rasquetas ERGO™ 625



449



€



25 mm

13,30

10

449

Hojas para rasqueta 625



625-



€



3 g

13,30

10

625-DROP

3 g

13,30

10

625-PEAR

3 g

13,30

10

625-ROUND

Rasqueta ergonómica



ergo



650



€



50 mm

29,42

5

650

Hojas de repuesto para rasquetas ERGO™ 625



442



€



50 mm

22,85

10

442-3P

50 mm

14,10

10

442

Hoja de rasqueta para pintura



850 / 865



€



50 mm

17,59

10

850-1

65 mm

19,40

10

865-1

Rasqueta ergonómica



ergo



665



€



65 mm

42,59

5

665

Hojas de repuesto para rasquetas ERGO™ 665



451



€



65 mm

15,52

10

451

Juego de rasquetas



ergo



SCRAPER-SET2



€



50 x 145 x 265 mm

108,01

1

SCRAPER-SET2

625

625-DROP, 625-PEAR, 625-ROUND

650



Rasqueta de carpintero



474

← L →	€		
130 mm	9,86	10	474-125-0.60
130 mm	10,01	10	474-125-0.80
150 mm	10,35	10	474-150-0.60
150 mm	10,52	10	474-150-0.80

Espátula con mango de madera riveteado



2155

	← L →	€		
30 mm	195 mm	7,42	12	215500300
40 mm	195 mm	8,07	12	215500400
50 mm	195 mm	8,28	12	215500500
60 mm	215 mm	8,44	12	215500600
70 mm	220 mm	8,64	12	215500700
80 mm	225 mm	9,04	12	215500800
90 mm	230 mm	9,23	12	215500900
100 mm	234 mm	9,63	12	215501000

Espátula Mango de Plástico de Acero al Carbono con virola



216

	← L →	€		
30 mm	210 mm	3,84	12	216000300
40 mm	210 mm	3,95	12	216000400
50 mm	210 mm	4,15	12	216000500
60 mm	210 mm	4,26	12	216000600
70 mm	210 mm	4,59	12	216000700
80 mm	210 mm	4,82	12	216000800
90 mm	228 mm	5,09	12	216000900
100 mm	230 mm	5,84	12	216001000
120 mm	230 mm	6,84	12	216001200

Espátula de Acero al Carbono Mango Bi Material



2150

	← L →	€		
30 mm	225 mm	4,52	12	215000030
40 mm	225 mm	4,69	12	215000040
50 mm	225 mm	4,87	12	215000050
60 mm	225 mm	5,00	12	215000060
70 mm	225 mm	5,39	12	215000070
80 mm	225 mm	5,70	12	215000080
90 mm	220 mm	6,14	12	215000090
100 mm	220 mm	6,89	12	215000100
120 mm	220 mm	8,45	12	215000120

Espátula Mango Bimaterial - Hoja Inox



2161

	← L →	€		
40 mm	215 mm	8,35	12	216100040
60 mm	215 mm	9,79	12	216100060
80 mm	215 mm	11,00	12	216100080
100 mm	235 mm	11,64	12	216100100
120 mm	235 mm	12,58	12	216100120

Espátula Rígida Mango de Plástico de Acero al carbono



2165

	← L →	€		
30 mm	180 mm	7,32	12	216500300
50 mm	180 mm	7,75	12	216500500
75 mm	200 mm	9,79	12	216500750
100 mm	200 mm	11,00	12	216501000

Espátula de emplastecer



2190

	← L →	€		
100 mm	235 mm	6,58	5	219001000
120 mm	230 mm	7,28	5	219001200
140 mm	245 mm	8,14	5	219001400
160 mm	235 mm	8,86	5	219001600
200 mm	245 mm	11,63	5	219002000

Espátula de emplastecer inoxidable



2192

	← L →	€		
100 mm	235 mm	10,66	5	219201000
120 mm	230 mm	11,67	5	219201200
140 mm	235 mm	14,32	5	219201400
160 mm	245 mm	15,88	5	219201600
200 mm	235 mm	19,94	5	219202000

Espátula de emplastecer inoxidable



2193

← L →	€		
250 mm	18,70	10	219302500
300 mm	20,07	10	219303000
350 mm	21,41	10	219303500



Espátula de encolar

**2212**

		€			
130 mm	120 mm	5,50	5		221201200
130 mm	200 mm	6,71	5		221202000
130 mm	300 mm	9,80	5		221203000

Espátula de encolar

**2213**

		€			
130 mm	120 mm	5,50	5		221301200
130 mm	200 mm	6,53	5		221302000
130 mm	300 mm	9,80	5		221303000

Cuchillo curvo

**2488**

€			
19,19	12		2488

Espátula

**2489**

€			
23,59	12		2489

Paleta de albañil modelo Madrid

**2303**

		€			
70 mm	110 mm	18,26	6		2303B0000
80 mm	135 mm	19,25	6		2303D0000

Paleta de albañil modelo Sevilla

**2304**

		€			
115 mm	200 mm	22,80	6		2304C0000

Paletín punta aguda

**2308**

		€			
120 mm	70 mm	18,67	6		2308A0000
150 mm	100 mm	19,37	6		2308B0000

HERRAMIENTAS PARA ALBAÑILERÍA

Llana - Rectangular

**204**

		€			
300 mm	150 mm	15,58	12		204030150
300 mm	160 mm	16,62	12		204030160
300 mm	180 mm	17,51	12		204030180
500 mm	130 mm	26,52	6		204050130

Llana dentada

**209**

		€			
270 mm	115 mm	16,20	12		209027040

Llana dentada



2092

Icon 1	Icon 2	€	Icon 3	Icon 4
275 mm	115 mm	15,73	12	209227060
280 mm	130 mm	16,62	12	209228100
500 mm	130 mm	28,16	6	209250100

Llana de Plástico Plana



211

Icon 1	Icon 2	€	Icon 3	Icon 4
350 mm	180 mm	8,02	5	211035180
420 mm	210 mm	10,49	5	211042210

Guión Yesero de Aluminio



2127

Icon 1	Icon 2	€	Icon 3	Icon 4
90 mm	435 mm	41,66	6	212704350

Llana de Acero Inoxidable



2045

Icon 1	Icon 2	€	Icon 3	Icon 4
300 mm	140 mm	18,58	12	204530140
500 mm	130 mm	28,58	6	204550130

2045A3000: Hoja afilada

Talocha de Plástico base estriada



2120

Icon 1	Icon 2	€	Icon 3	Icon 4
270 mm	180 mm	6,20	5	212027180
330 mm	220 mm	6,72	8	212033220

Carril cuchillas dentadas y rectas



2145xxxD

Icon 1	€	Icon 2	Icon 3
45 x 20 x 275 mm	13,02	1	2145020D0
45 x 25 x 275 mm	13,16	1	2145025D0
45 x 30 x 275 mm	13,33	1	2145030D0
45 x 35 x 275 mm	13,59	1	2145035D0

Llana de acero inoxidable para emplastecer



2045A

Icon 1	Icon 2	€	Icon 3	Icon 4
140 mm	300 mm	20,25	12	2045A3000

Talocha de Plástico con Punta



213

Icon 1	Icon 2	€	Icon 3	Icon 4
265 mm	140 mm	5,14	5	213026140

Carril cuchillas rectas sin dentar



2145xxxL

Icon 1	€	Icon 2	Icon 3
45 x 20 x 275 mm	13,02	1	2145020L0
45 x 25 x 275 mm	13,16	1	2145025L0
45 x 30 x 275 mm	13,33	1	2145030L0
45 x 35 x 275 mm	13,59	1	2145035L0



Carril cuchillas curvas sin dentar



2145xxxC

	€		
45 x 25 x 225 mm	13,59	1	2145025C0
45 x 35 x 210 mm	13,93	1	2145039C0

Talocha Goma Dura



2125

		€		
220 mm	135 mm	12,58	10	212502150



Repuesto para elevador (cable)



250400020

	€		
180 g	72,11	1	250400020

Talocha para Soldadores



2122

		€		
250 mm	100 mm	20,97	10	212202500



Talocha Goma Blya



2126

		€		
140 mm	220 mm	14,75	10	212602150
140 mm	280 mm	19,33	1	212602800



Repuesto para elevador (mango antena)



250400030

	€		
80 g	135,47	1	250400030

Talocha Esponja



2123

		€		
140 mm	280 mm	15,60	10	212302900



HERRAMIENTAS PARA PAREDES DE PLACAS DE ESCAYOLA

Set de repuestos elevación (2muelles+freno)



250400010

	€		
80 g	40,88	1	250400010

Pinza especial para colgar tacos metalicos en materiales huecos



250501800

	€		
185 mm	65,87	50	250501800



Pinza especial para colgar tacos metálicos en materiales huecos



250502450

245 mm
 € 73,38
 1
 250502450



Inglete de repuesto para 864



864000020

20 g
 € 11,63
 1
 864000020

Pinza para unir perfiles sin remache



671002600

260 mm
 € 148,67
 50
 671002600



Tijera para ingletes



8640

230 mm
 € 66,34
 50
 864002450



Tijera para Ingletes



8641

245 mm
 € 63,72
 1
 864102400



Pinza para unir perfiles sin remache



671002850

295 mm
 € 113,57
 1
 671002850



Hoja de repuesto para 8640



864000010

20 g
 € 20,40
 1
 864000010

Hoja de repuesto para 8641



864100010

5 g
 € 11,73
 1
 864100010





BAHCO



Arcos de sierra manuales



ARCOS DE SIERRA

Arco de sierra para metales - profesional



ergo®



325

	€			
300 mm	48,23	5	325	

Arco de sierra para metales - compacto



317

	€			
432 mm	19,50	10	317	

Arco de sierra



304

	€			
517 mm	7,89	10	304	

Arco de sierra para metales - profesional



225-PLUS

	€			
300 mm	31,08	5	225-PLUS	

Arco de sierra para metales - compacto



306

	€			
440 mm	15,14	10	306	

Mini arco de sierra para metales



208

	€			
330 mm	16,53	5	208	

Hoja Sandflex® para sierra compás



321

	€			
330 g	35,64	5	321	

Arco de sierra para metales - profesional



319

	€			
300 mm	26,91	5	319	

Arco de sierra tradicional



320

	€			
504 mm	22,40	10	320	

Sierra universal con doble hoja 300mm/12"



210

	€			
360 g	31,80	10	210	

Mini arco para metal



268

L	€	Icon	Icon
150 mm	13,18	5	268

Mini arco para metal



228

L	€	Icon	Icon
150 mm	11,49	80	228
150 mm	10,46	5	228-BULK

HOJAS DE ARCOS DE SIERRA

Hoja Spiro Sandflex® Bi-metal



3806-SPIRO

L	T ₁	€	Icon	Icon
600 mm	32	26,16	10	3806-600-32

Mini arco para metal



239

L	€	Icon	Icon
260 mm	5,81	150	239

Mini arco para metal



219

L	€	Icon	Icon
291 mm	5,40	120	219

Hoja de sierra de mano - para metal



3906

L	T ₁	€	Icon	Icon
250 mm	18	1,93	100	3906-250-18-100
250 mm	24	1,93	100	3906-250-24-100
250 mm	32	1,93	100	3906-250-32-100
300 mm	14	2,17	100	3906-300-14-100
300 mm	18	2,17	100	3906-300-18-100
300 mm	24	2,17	100	3906-300-24-100
300 mm	32	2,17	100	3906-300-32-100
300 mm	18-28	2,30	100	3818-300-PROG-100
300 mm	14	33,86	10	3906-300-14-10P
300 mm	18	21,68	10	3906-300-18-10P
300 mm	24	27,59	10	3906-300-24-10P
300 mm	32	27,59	10	3906-300-32-10P
250 mm	18	10,17	10	3906-250-18-5P
250 mm	24	10,17	10	3906-250-24-5P
250 mm	32	10,17	10	3906-250-32-5P
300 mm	14	11,45	10	3906-300-14-5P
300 mm	18	14,05	10	3906-300-18-5P
300 mm	24	14,05	10	3906-300-24-5P
300 mm	32	14,05	10	3906-300-32-5P
300 mm	18-28	14,44	10	3818-300-PROG-5P
300 mm	18/24/32	8,70	10	3906-300-3P
300 mm	18	5,99	10	3906-300-18-2P
300 mm	24	5,99	10	3906-300-24-2P
300 mm	32	5,99	10	3906-300-32-2P

Mini arco para metal



238

L	€	Icon	Icon
150 mm	11,71	60	238

Mini arco para metal



218

L	€	Icon	Icon
235 mm	4,14	10	218
235 mm	2,88	150	218-BULK



Hoja de sierra de mano, acero rápido



3905

L		€		
250 mm	24	2,20	100	3905-250-24-100
300 mm	14	2,30	100	3905-300-14-100
300 mm	18	2,30	100	3905-300-18-100
300 mm	24	2,30	100	3905-300-24-100
300 mm	32	2,15	100	3905-300-32-100
300 mm	24	5,99	10	3905-300-24-2P

Hoja de repuesto para mini-arcos de sierra

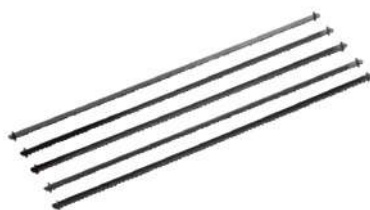

228-P

L		€		
150 mm	15	4,14	10	228-15-5P
150 mm	32	4,14	10	228-32-5P
150 mm	32	4,90	10	228-32-10P
150 mm	32	28,68	1	228-32-100P

Hoja con dentado de carburo de tungsteno



3816

L		€		
300 mm	12	12,83	50	3816-300

Hoja recubierta de carburo de tungsteno



216-R

L		€		
150 mm	20	7,02	1	216-150-R
300 mm	20	10,34	1	216-300-R

Hoja de recambio para mini arco



215

L		€		
150 mm	110	7,02	1	215-150

Hoja Sandflex® intercambiable para sierra calar 321



321-SB

L		€		
310 mm	7	17,81	10	321-7-SB
310 mm	18	18,99	10	321-18-SB
310 mm	24	19,30	10	321-24-SB



Serruchos



SERRUCHOS PARA MATERIALES DE CONSTRUCCION

Serrucho universal



PC-GNP

		€		
375 mm	15/16	28,50	4	PC-15-GNP

Serrucho de calar



NP-COM

		€		
300 mm	7/8	15,41	4	NP-12-COM

Serrucho para yeso



PC-PLS

		€		
600 mm	7/8	36,93	4	PC-24-PLS

Hoja de serrucho Superior para uso general



EX-16-GNP-C

		€		
400 mm	15/16	32,11	10	EX-16-GNP-C

Serrucho de calar - diente templado



PC-COM

		€		
300 mm	9/10	21,57	4	PC-12-COM

Hoja de serrucho Superior para escayola



EX-22-PLS-C

		€		
550 mm	7/8	40,34	10	EX-22-PLS-C

Serrucho de calar superior



3150

		€		
300 mm	9/10	35,66	4	3150-12-XT9-HP

Serrucho para placas de escayola



PC-6-DRY

		€		
160 mm	8	22,95	6	PC-6-DRY

Serrucho para serrar todo tipo de plásticos



PC-22-PLC

		€		
550 mm	11/12	31,17	4	PC-22-PLC

Serrucho para poliestireno



PC-DECO

		€		
400 mm	18/19	28,50	4	PC-16-DECO

Serrucho para bloque de hormigón celular



256

		€		
650 mm	2	69,39	4	256-26

Serrucho universal



300

		€		
350 mm	15/16	20,02	4	300-14-F15/16-HP

Arco de metales para cemento poroso y bloques LEKA



255-34

		€		
620 mm	1,3	64,84	2	255-34

Serrucho para material aislante



PC-22-INS

		€		
550 mm	WT	31,02	4	PC-22-INS

Serrucho multiuso



369

		€		
360 mm	13/14	19,55	20	369-BLADE

Arco de sierra para cemento poroso y bloques LEKA



255-17/34

		€		
620 mm	0.6	56,84	2	255-17/34

Serrucho plegable aislante



396-INS

		€		
190 mm	WT	25,96	10	396-INS

SERRUCHOS PARA MADERA

Serrucho - diente templado



NP

		€		
400 mm	7/8	14,52	4	NP-16-U7/8-HP
475 mm	7/8	14,52	10	NP-19-U7/8-HP
550 mm	7/8	15,51	10	NP-22-U7/8-HP



Prizecut + hoja BHS



EX-NPP-22

		€		
550 mm	7/8	18,90	10	EX-NPP-22

Hoja PrizeCut BHS



EX-22-U7

		€		
550 mm	7/8	15,49	10	EX-22-U7

Serrucho superior para caja de herramientas



ergo®



2600-16

		€		
400 mm	11/12	56,58	4	2600-16-XT11-HP

Hoja de serrucho Superior Media



EX-XT9

		€		
475 mm	9/10	42,70	10	EX-19-XT9-C
550 mm	9/10	44,19	10	EX-22-XT9-C

Serrucho - diente templado



PC-GT7

		€		
475 mm	7/8	29,16	4	PC-19-GT7
550 mm	7/8	30,48	4	PC-22-GT7

Serrucho de costilla superior



ergo®



3180

		€		
350 mm	11/12	50,20	4	3180-14-XT11-HP

Sierra de mano - corte transversal



NP-FLEEM

		€		
550 mm	7	15,83	10	NP-22-F7/8-HP

Serrucho - reafilable



PC-FILE

		€		
400 mm	7/8	19,34	4	PC-16-FILE-U7
475 mm	7/8	20,68	4	PC-19-FILE-U7
550 mm	7/8	22,00	4	PC-22-FILE-U7
600 mm	7/8	31,46	4	PC-24-FILE-U7

Serrucho de ranurar superior



ergo®



3240

		€		
350 mm	11/12	42,34	4	3240-14-XT11-HP

Serrucho - diente templado



ergo®



2600

Longitud	Diente	€	Pack	Modelo
475 mm	9/10	58,75	4	2600-19-XT-HP
550 mm	9/10	60,55	4	2600-22-XT-HP



Serrucho para el aserrado de madera tamaño medio a grueso



244

Longitud	Diente	€	Pack	Modelo
500 mm	7/8	24,44	10	244-20-U7/8-HP
550 mm	7/8	25,42	10	244-22-U7/8-HP



Hoja de serrucho Superior Fina



EX-20-XT11-C

Longitud	Diente	€	Pack	Modelo
500 mm	11/12	44,19	10	EX-20-XT11-C



Serrucho - diente templado



2500 XT

Longitud	Diente	€	Pack	Modelo
400 mm	11/12	44,19	4	2500-16-XT-HP
475 mm	9/10	45,55	4	2500-19-XT-HP
550 mm	9/10	46,88	4	2500-22-XT-HP
600 mm	7/8	48,72	4	2500-24-XT7-HP



Hoja de serrucho Superior laminator



EX-20-LAM-C

Longitud	Diente	€	Pack	Modelo
500 mm	11/12	45,13	10	EX-20-LAM-C



Hoja de serrucho de costilla Superior



EX-14-TEN-C

Longitud	Diente	€	Pack	Modelo
350 mm	11/12	36,62	5	EX-14-TEN-C



Serrucho Laminator



PC-LAM

Longitud	Diente	€	Pack	Modelo
500 mm	11/12	31,83	4	PC-20-LAM



Serrucho superior



ergo®



3090

Longitud	Diente	€	Pack	Modelo
500 mm	11/12	55,49	4	3090-20-XT11-HP



Serrucho superior para laminados



ergo®



SUP-LAM

Longitud	Diente	€	Pack	Modelo
500 mm	11/12	56,65	4	SUP-20-LAM



Hoja de serrucho Superior para ranurar



EX-14-VEN-C

Longitud	Diente	€	Pack	Modelo
350 mm	11/12	30,83	10	EX-14-VEN-C



Serrucho - diente templado



PC-GT9

Longitud	Diente	€	Pack	Modelo
475 mm	9/10	29,16	4	PC-19-GT9
550 mm	9/10	30,48	4	PC-22-GT9

Serrucho de ranurar - diente templado



PC-VEN

Longitud	Diente	€	Pack	Modelo
300 mm	11/12	33,61	4	PC-12-VEN

Serrucho de costilla



NP-VEN

Longitud	Diente	€	Pack	Modelo
300 mm	13/14	18,92	10	NP-12-VEN

Serrucho para caja de herramientas - diente templado



PC-TBX

Longitud	Diente	€	Pack	Modelo
375 mm	11/12	27,49	4	PC-15-TBX

Serrucho de precisión



PC-PRC

Longitud	Diente	€	Pack	Modelo
500 mm	9/10	48,19	4	PC-20-PRC

Hoja de serrucho Superior gruesa



EX-XT7

Longitud	Diente	€	Pack	Modelo
550 mm	7/8	44,19	10	EX-22-XT7-C
600 mm	7/8	45,75	10	EX-24-XT7-C

Serrucho de costilla - diente templado



PC-TEN

Longitud	Diente	€	Pack	Modelo
300 mm	11/12	31,07	4	PC-12-TEN

Serrucho de costilla



NP-TEN

Longitud	Diente	€	Pack	Modelo
300 mm	13/14	18,09	10	NP-12-TEN

Hoja Barracuda BHS



EX-244P-22

Longitud	Diente	€	Pack	Modelo
550 mm	7/8	23,09	10	EX-244P-22

Serrucho para el aserrado de madera de tamaño medio a grueso



244P

Longitud	Perfil de corte	€	Pack	Modelo
500 mm	7/8	27,49	4	244P-20-U7-HP
550 mm	7/8	28,55	10	244P-22-U7-HP



Ingletes en madera maciza



233

Dimensiones	€	Pack	Modelo
65 x 135 x 300 mm	18,87	5	233-300
75 x 135 x 300 mm	25,86	5	233-300-A
65 x 135 x 400 mm	27,51	5	233-400



SERRUCHOS DE PRECISIÓN

Serrucho de ranurar para carpintería



PC-12-PS

Longitud	Perfil de corte	€	Pack	Modelo
305 mm	13.5	41,58	4	PC-12-14-PS
305 mm	13.5	29,00	10	PC-12-14-PS-B



Serrucho superior



ergo®



2700

Longitud	Perfil de corte	€	Pack	Modelo
550 mm	7/8	61,71	4	2700-22-XT7-HP
600 mm	7/8	62,60	4	2700-24-XT7-HP



Ingletes en madera laminada



234-W

Dimensiones	€	Pack	Modelo
53 x 77 x 245 mm	8,72	10	234-W1
63 x 95 x 300 mm	10,86	10	234-W2
80 x 100 x 300 mm	14,04	10	234-W3



Serrucho de ranurar para cortes extra finos de precisión



PC-11-PS

Longitud	Perfil de corte	€	Pack	Modelo
270 mm	18.5	45,87	4	PC-11-19-PS
270 mm	18.5	31,31	10	PC-11-19-PS-B



Serrucho para aglomerados



PC-TIM

Longitud	Perfil de corte	€	Pack	Modelo
600 mm	3.5/4.5	49,68	4	PC-24-TIM



Ingletes en aluminio



234-A

Dimensiones	€	Pack	Modelo
55 x 65 x 245 mm	20,52	1	234-A1
40 x 106 x 245 mm	21,67	1	234-A2



Sierra de doble filo corte fino



PC-9-PS

Longitud	Perfil de corte	€	Pack	Modelo
240 mm	6-8.5 / 17	42,15	4	PC-9-9/17-PS
240 mm	6-8.5 / 17	31,58	10	PC-9-9/17-PS-B



Serrucho de ebanista - mango recto



PC-DTF

		€		
250 mm	15/16	27,46	10	PC-10-DTF



MANGOS Y AFILADORES

Mango de serrucho ERGO™ para hojas intercambiables



EX-

	€		
120 x 330 x 60 mm	39,56	4	EX-LL
120 x 330 x 60 mm	39,56	4	EX-RM
120 x 330 x 60 mm	39,56	4	EX-RL



L: Zurdos; R: Diestros

Arco de marquetería



502

	€		
130 mm	10,03	25	502



Serrucho de ebanista - mango recto



PC-DTR

		€		
250 mm	15/16	17,96	10	PC-10-DTR



Afilador Para Serrucho Material Aislante HSS



SHARP-INS

	€		
206 mm	10,80	100	SHARP-INS



Juegos de arcos de marquetería, 2 unidades



502-SET2

		€		
2	130 g	5,82	35	502-SET2



Serrucho de ebanista - mango angulado



PC-DTL

		€		
250 mm	15/16	17,96	10	PC-10-DTL



Arco de marquetería



302

	€		
130 mm	18,37	30	302



Juegos de arcos de marquetería, 6 unidades



502-SET6

		€		
6	500 g	26,06	10	502-SET6

Juego de hojas para mini-arco



302-6X4P



Icon	€	Icon	Icon
	10,01		
130 mm		1	302-6X4P

Hoja de repuesto para arcos de marquetería 302 y 502



302W



Icon	Icon	€	Icon	Icon
1	130 mm	3,14	1	302-51W-12P
3	130 mm	3,14	1	302-53W-12P
5	130 mm	3,14	1	302-55W-12P
7	130 mm	3,71	1	302-57W-12P
9	130 mm	4,21	1	302-59W-12P
11	130 mm	4,56	1	302-511W-12P

SERRUCHO "MUSICAL"

Serrucho musical



296

Icon	€	Icon	Icon
	151,32		
750 mm		1	296

Hoja repuesto para arcos 202, y 502



302M



Icon	Icon	€	Icon	Icon
1	130 mm	5,22	1	302-71M-12P
3	130 mm	5,23	1	302-73M-12P
5	130 mm	6,29	1	302-75M-12P
7	130 mm	6,80	1	302-77M-12P

ARCOS Y HOJAS PARA RECORTE

Mini-arco para recorte



301



Icon	€	Icon	Icon
	18,81		
165 mm		50	301

12 Hojas de repuesto - madera/plástico:
1.fina



302S



Icon	Icon	€	Icon	Icon
1	130 mm	4,44	1	302-81S-12P
3	130 mm	4,44	1	302-83S-12P
5	130 mm	5,02	1	302-85S-12P

5 hojas de repuesto para mini-arco 301

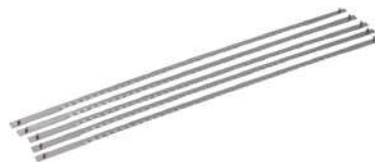

303



Icon	€	Icon	Icon
	5,05		
165 mm		10	303-5P



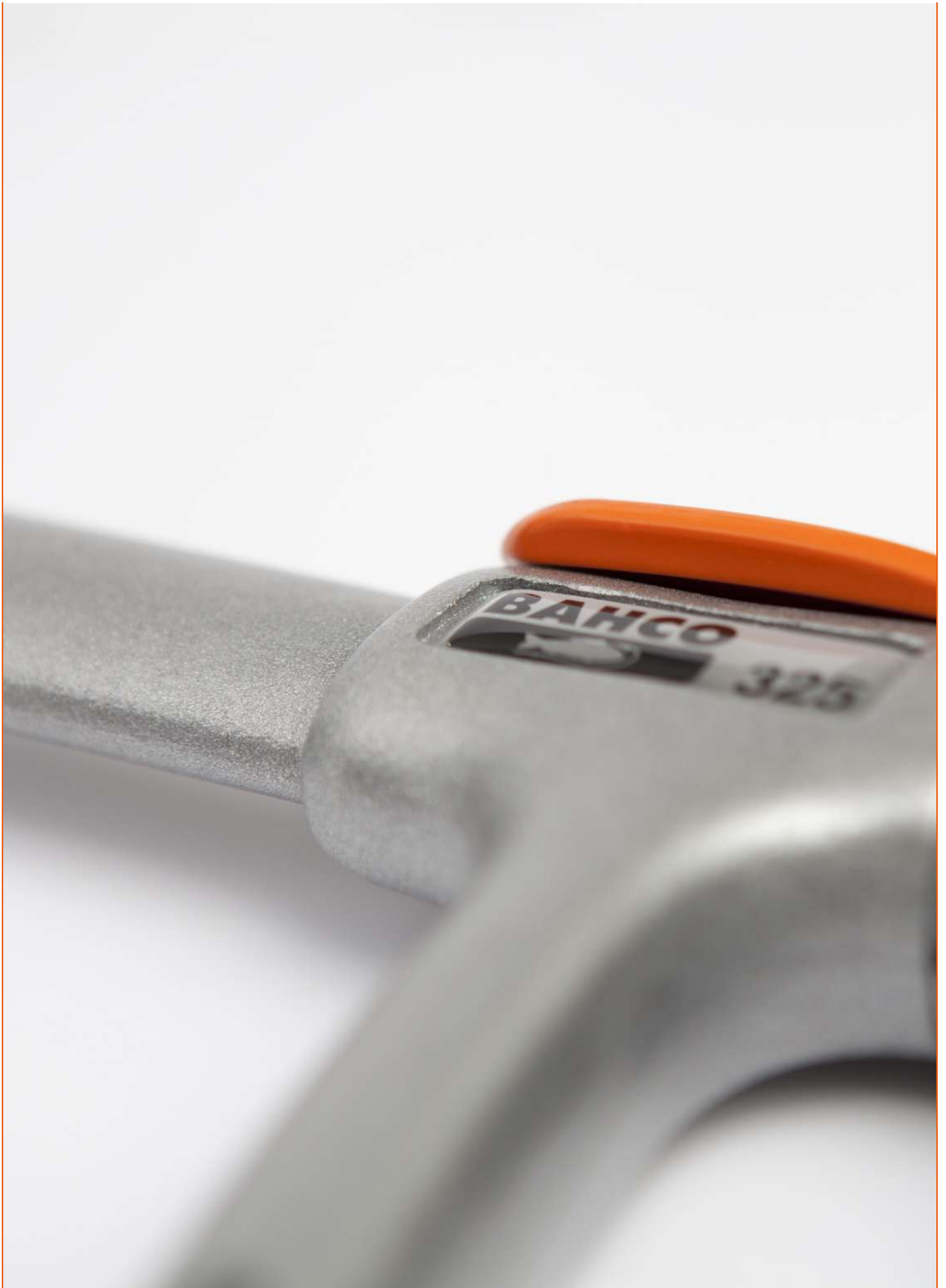

BAHCO



Formones



FORMONES

Formón Ergo™



ergo



434

	€		
6 mm	22,84	4	434-6
8 mm	23,56	4	434-8
10 mm	23,94	4	434-10
12 mm	24,51	4	434-12
14 mm	25,08	4	434-14
15 mm	25,34	4	434-15
16 mm	25,77	4	434-16
18 mm	26,19	4	434-18
20 mm	26,73	4	434-20
22 mm	27,43	4	434-22
25 mm	28,13	4	434-25
28 mm	29,14	4	434-28
30 mm	29,56	4	434-30
32 mm	30,12	4	434-32
35 mm	30,94	4	434-35
38 mm	31,93	4	434-38
50 mm	36,65	4	434-50

Adecuado para un uso intensivo con martillo metálico

Juego de 3 formones Ergo™ en caja de cartón



ergo



434-S3-EUR

	€		
3	78,84	1	434-S3-EUR

Adecuado para un uso intensivo con martillo metálico

434-12, 434-18, 434-25

Juego de 6 cinceles ERGO™ en bolsa de cuero



ergo



434-S6-LR

	€		
6	175,73	1	434-S6-LR

434-6, 434-10, 434-12, 434-18, 434-25, 434-32

Juego de 6 formones Ergo™ en caja de madera



ergo



434-S6-EUR

	€		
6	156,01	1	434-S6-EUR

Adecuado para un uso intensivo con martillo metálico

434-6, 434-10, 434-12, 434-18, 434-25, 434-32

Juego de 8 formones Ergo™ en caja de madera



ergo



434-S8-EUR

	€		
8	178,18	1	434-S8-EUR

Adecuado para un uso intensivo con martillo metálico

434-6, 434-10, 434-12, 434-16, 434-18, 434-25, 434-32, 434-38

Juego de 6 formones Ergo™ en bolsa de poliéster



ergo



434-S6-PP

	€		
6	158,05	1	434-S6-PP

Adecuado para un uso intensivo con martillo metálico

434-6, 434-10, 434-12, 434-18, 434-25, 434-32

Formón profesional con mango bi-componente



424P

	€		
4 mm	17,75	4	424P-4
6 mm	18,20	4	424P-6
8 mm	18,65	4	424P-8
10 mm	19,10	4	424P-10
12 mm	19,55	4	424P-12
14 mm	20,01	4	424P-14
15 mm	20,22	4	424P-15
16 mm	20,46	4	424P-16
18 mm	20,91	4	424P-18
20 mm	21,36	4	424P-20
22 mm	21,80	4	424P-22
24 mm	22,26	4	424P-24
25 mm	22,46	4	424P-25
26 mm	22,71	4	424P-26
28 mm	23,17	4	424P-28
30 mm	23,62	4	424P-30
32 mm	24,06	4	424P-32
35 mm	24,74	4	424P-35
38 mm	25,42	4	424P-38
40 mm	25,87	4	424P-40

Juego de 3 formones con mango bi-material en caja de cartón



424P-S3-EUR

	€		
3	62,95	1	424P-S3-EUR

424P-12, 424P-18, 424P-25

Juego de 6 cinceles Professional en bolsa de cuero



424P-S6-LR

	€		
6	137,66	1	424P-S6-LR

424P-6, 424P-10, 424P-12, 424P-18, 424P-25, 424P-32

Juego de 6 formones profesionales con mango bi-material en caja de madera



424P-S6-EUR

	€		
6	144,69	1	424P-S6-EUR

424P-6, 424P-10, 424P-12, 424P-18, 424P-25, 424P-32

Juego de 6 formones con mango bi-componente en bolsa de poliéster



424P-S6-PP

	€		
6	97,98	1	424P-S6-PP

424P-6, 424P-10, 424P-12, 424P-18, 424P-25, 424P-32

	€		
10 mm	26,68	5	1031-10
12 mm	27,37	5	1031-12
14 mm	27,91	5	1031-14
16 mm	28,45	5	1031-16
18 mm	29,12	5	1031-18
20 mm	29,81	5	1031-20
22 mm	30,46	5	1031-22
25 mm	31,28	5	1031-25
28 mm	32,23	5	1031-28
30 mm	32,88	5	1031-30
32 mm	33,57	5	1031-32
40 mm	35,99	5	1031-40

Juego de 6 formones con mango bi-componente en caja de madera



424P-S6-GER

	€		
6	134,56	1	424P-S6-GER

424P-6, 424P-10, 424P-12, 424P-16, 424P-20, 424P-26

Formón con mango de polipropileno



414

	€		
6 mm	15,25	4	414-6
8 mm	15,60	4	414-8
10 mm	15,42	4	414-10
12 mm	16,44	4	414-12
14 mm	16,77	4	414-14
15 mm	16,91	4	414-15
16 mm	17,10	4	414-16
18 mm	17,56	4	414-18
20 mm	17,89	4	414-20
22 mm	18,35	4	414-22
25 mm	18,84	4	414-25
28 mm	19,48	4	414-28
30 mm	19,79	4	414-30
32 mm	20,12	4	414-32
35 mm	20,75	4	414-35
38 mm	21,23	4	414-38

Juego de 3 formones con mango de polipropileno en caja de cartón



414-S3-EUR

	€		
3	52,83	1	414-S3-EUR

414-12, 414-18, 414-25

Juego de 8 formones con mango bi-componente en caja de madera



424P-S8-EUR

	€		
8	197,31	1	424P-S8-EUR

424P-6, 424P-10, 424P-12, 424P-16, 424P-18, 424P-25, 424P-32, 424P-38

Formón con mango monomaterial rojo



1031

	€		
4 mm	24,80	5	1031-4
6 mm	25,35	5	1031-6
8 mm	25,88	5	1031-8

Juego de 5 formones con mango monomaterial rojo, en blister



9883

	€		
5	142,23	1	9883

1031-6, 1031-12, 1031-16, 1031-20, 1031-25



Formón con mango de madera



425

	€		
4 mm	13,51	4	425-4
6 mm	14,01	4	425-6
8 mm	14,21	4	425-8
10 mm	14,54	4	425-10
12 mm	14,89	4	425-12
14 mm	15,23	4	425-14
15 mm	15,41	4	425-15
16 mm	15,58	4	425-16
18 mm	15,94	4	425-18
20 mm	16,27	4	425-20
22 mm	16,60	4	425-22
24 mm	16,97	4	425-24
25 mm	17,13	4	425-25
26 mm	17,30	4	425-26
28 mm	17,64	4	425-28
30 mm	18,01	4	425-30
32 mm	18,32	4	425-32
35 mm	18,86	4	425-35
38 mm	19,40	4	425-38
40 mm	19,69	4	425-40

Juego de 3 formones con mango de madera en caja de cartón



425-081

	€		
3	47,95	1	425-081

425-12, 425-18, 425-25

Juego de 5 formones con mango de madera en caja de cartón



425-082

	€		
5	76,39	1	425-082

425-6, 425-10, 425-12, 425-18, 425-25

Juego de 6 formones con mango de madera en caja de madera



425-083

	€		
6	100,87	1	425-083

425-6, 425-10, 425-12, 425-18, 425-25, 425-32

Mango de repuesto para formones 1031



956

	g	€		
108 mm	50 g	5,42	1	956

CINCELES GUBIA

Gubias profesionales con mango bi-componente



422P

	€		
6 mm	36,41	4	422P-6
10 mm	36,86	4	422P-10
12 mm	36,86	4	422P-12
16 mm	36,86	4	422P-16
20 mm	39,06	4	422P-20
25 mm	46,40	4	422P-25

CINCELES DE DEMOLICIÓN

Cuchillo formón



2448

	L	€		
25 mm	231 mm	29,91	12	2448
25 mm	240 mm	30,67	12	SB-2448

Cuchillo alta resistencia hoja curvada caja expositora 12 uds



2449

	L	€		
25 mm	235 mm	27,49	12	2449
25 mm	235 mm	27,49	10	SB-2449

ACCESORIOS PARA FORMONES

Piedra de afilado natural



528-700



150 mm

€

48,52



1 528-700

Bloque para afilado



SBC110



30 x 65 x 110 mm



67 g

€

2,49



1 SBC110-65

Piedra de afilado - 2 granos



528-COM



150 mm

€

40,60



1 528-COM

Hoja de repuesto para disco de esmerilado



BP-40-95



112 mm



55 g

€

3,85



12 BP-40-95

Accesorio para formones



BP-40



160 mm

€

49,13



1 BP-40

Funda protectora de plástico



WC-HOL



292 mm

€

4,13



1 WC-HOL





BAHCO



Tijeras y cuchillos



TIJERAS CORTACHAPAS

Tijera cortachapas articulada, corte recto



MA421

	€		
250 mm	29,61	10	MA421

Tijera cortachapas multiuso, corte largo



MA431

	€		
290 mm	32,48	1	MA431

0.53mm acero inox 0.94mm laminado en frío

Tijera cortachapa articulada, corte derecha



MA411

	€		
250 mm	29,61	10	MA411

8698M0250: Juego de piezas de repuesto (tuerca, muelle y husillo)

Tijera cortachapa articulada profesional, corte derecha



MA321

	€		
260 mm	38,66	10	MA321

0.9mm acero inox 1.5mm laminado en frío

Tijera cortachapa articulada, corte izquierda



MA401

	€		
250 mm	29,61	10	MA401

8698M0250: Juego de piezas de repuesto (tornillo, muelle y husillo)

Tijera cortachapas articulada profesional, corte izquierda



MA311

	€		
260 mm	38,66	1	MA311

0.9mm acero inox 1.5mm laminado en frío

Tijera para chapa



MA225

	€		
250 mm	48,99	4	MA225

Tijera para chapa



MA225R

	€		
250 mm	51,01	4	MA225R

Tijera para chapa



MA225L

	€		
250 mm	51,01	4	MA225L

Tijera cortachapa articulada, corte derechas



MA361

	€		
260 mm	43,30	10	MA361

1mm acero inox 1.5mm laminado en frío

Tijera para chapa tradicional



MR340

	€		
340 mm	92,78	2	MR340

Tijera para chapa tradicional



585D

	€		
280 mm	84,55	4	585D

Tijera cortachapas articulada profesional, corte izquierda



MA351

	€		
250 mm	43,30	10	MA351

1mm Acero inox 2mm Laminado en frío

Tijera para chapa tradicional



583D

	€		
280 mm	87,80	4	583D

Tijera para chapa tradicional



586D

	€		
280 mm	82,17	4	586D

Tijera para chapa



MA325

	€		
250 mm	58,76	4	MA325

Tijera para chapa tradicional



584D

	€		
280 mm	84,63	4	584D

Tijera para chapa tradicional



M227L

	€		
270 mm	36,92	4	M227L

0.6mm Acero inox 1.2mm Acero laminado



Tijera para chapa tradicional



M227R

	€		
270 mm	36,92	4	M227R

Tijera para chapa modelo Madrid



8691

	€		
255 mm	31,58	6	869102500
300 mm	39,62	6	869103000

Tijera para chapa tradicional



MR227R

	€		
270 mm	45,55	4	MR227R

Tijera para chapa tradicional



M330

	€		
11 3/4 mm	72,01	4	M330

Tijeras para chapa modelo Catalán



8692

	€		
300 mm	30,35	6	869203000

Tijeras para chapa de dos manos



M6376

	€		
760 mm	293,24	1	M6376
	125,67	1	M6376-SH

Tijera para chapa tradicional



M526

	€		
260 mm	37,32	4	M526

Tijera para chapa tradicional



MR227L

	€		
270 mm	45,96	4	MR227L

Tijera para chapa de dos manos



M676

	€		
760 mm	283,73	1	M676
	125,44	1	M676-SH

SH: Cuchilla repuesto

Tijeras para chapa - cizalla



M926

Diagram	€	Icons	Product Code
	82,93		1 M926
250 mm	18,33		1 M926-SH

SH: Cuchilla repuesto

Tijera electricista 140mm con entalla



SCB140G

Diagram	Diagram	€	Icons	Product Code
		29,12		10 SCB140G
43 mm	140 mm			

Tijera de electricista, modelo extra fuerte



SC150NG

Diagram	Diagram	€	Icons	Product Code
		18,74		10 SC150NG
38 mm	155 mm			

Tijera multi-uso



2744

Diagram	€	Icons	Product Code
	21,88		6 2744
190 mm			

Tijera de electricista



SC127/SC127S

Diagram	Diagram	€	Icons	Product Code
		12,83		10 SC127
45 mm	130 mm	13,24		10 SC127S
45 mm	127 mm			

S= Con corte dentado

Tijera especial corta para estaño



2704

Diagram	€	Icons	Product Code
	35,54		1 2704A
110 mm			

TIJERAS ELECTRICISTA

Tijera electricista 140mm



SCB140

Diagram	Diagram	€	Icons	Product Code
		26,53		10 SCB140
43 mm	140 mm			

Tijera de electricista



SC140/SC140C

Diagram	Diagram	€	Icons	Product Code
		13,49		10 SC140
50 mm	145 mm	14,14		10 SC140C
50 mm	145 mm			

C=Curva

Tijera especial para agarrar



2705R

Diagram	€	Icons	Product Code
	30,73		1 2705R
160 mm			



CUCHILLOS

Cutter retráctil ERGO™



ergo



KERU01

		€		
170 mm	26 mm	20,87	5	KERU-01

Cutter retráctil ERGO™

Cutter ERGO™



ergo



KEFU-01

		€		
170 mm	26 mm	18,77	5	KEFU-01

Cutter ERGO™ hoja seccionable 18mm



ergo



KE18-01

		€		
161 mm	26 mm	16,00	5	KE18-01

Cutter retráctil



KBRU-01

		€		
170 mm	26 mm	18,01	5	KBRU-01

Cutter retráctil



KGRU-01

		€		
160 mm	26 mm	12,85	5	KGRU-01

Cutter retráctil



KGRU-02

		€		
145 mm	26 mm	11,43	5	KGRU-02

Cutter mini retráctil



KMU-01

		€		
90 mm	26 mm	8,58	5	KMU-01

Cutter de hoja deslizante



SQZ150003

		€		
170 mm	60 mm	24,11	6	SQZ150003

Cutter cuchilla fija



KBFU-01

		€		
170 mm	26 mm	16,21	5	KBFU-01

Cutter cuchilla fija



KGFU-01

		€		
160 mm	26 mm	11,57	5	KGFU-01

Hojas para cutter



KBGU

	€		
0.635 x 19 x 60 mm	32,60	1	KBGU-100P

Dispensador hojas gancho, 5 piezas



KBGH-5P-DISPEN

	€		
0.635 x 19 x 51 mm	3,42	20	KBGH-5P-DISPEN

Cutter hoja seccionable ABS mango TPR 9 mm



KB09-01

	€		
140 mm	8,58	5	KB09-01

Dispensador hojas trapezoidales, 5 piezas



KBGU-5P-DISPEN

	€		
0.635 x 19 x 60 mm	2,93	20	KBGU-5P-DISPEN

Dispensador hojas seguridad, 5 piezas



KBGR-5P-DISPEN

	€		
0.635 x 19 x 55 mm	4,69	20	KBGR-5P-DISPEN

Cutter hoja seccionable 18mm TPR



KB18-01

	€		
160 mm	10,87	5	KB18-01

Dispensador con 10 hojas trapezoidales



KBGU-10P-DISPEN

	€		
0.635 x 19 x 60 mm	5,05	20	KBGU-10P-DISPEN

Hojas de recambio



SQZ150003-HSBL

	€		
51 mm	14,36	6	SQZ150003-HSBL

Cutter hoja seccionable 9 mm



KG09-01

	€		
140 mm	6,15	5	KG09-01
140 mm	18,44	10	KG09-01-3P

Hojas de recambio en forma de gancho para cutter universal



Cutter hoja seccionable 18mm



KG18-01



160 mm

€

7,99



5 KG18-01

Dispensador hojas Snap Off 18mm, 5 piezas



KUBG18-5DISPEN



15 x 30 x 130 mm

€

4,19



20 KUBG18-5DISPEN

Soporte para navaja



KHU-01



90 g

€

4,82



4 KHU-01

Dispensador 10 hojas Snap Off 9 mm



KSBG09-10DISPEN



1 x 9 x 85 mm

€

4,50



20 KSBG09-10DISPEN

Dispensador con 10 hojas de 18 mm



KSBG18-10DISPEN



15 x 30 x 130 mm

€

5,88



20 KSBG18-10DISPEN

Mini cutter multi usos



SQZ-MINI



160 mm

€

9,72

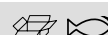

24 SQZ-MINI

Pack de 5 hojas no seccionables 18 mm



KUBG



0.7 x 85 x 9 mm

€

3,05



20 KUBG09-5P

Cuchillo de seguridad



KGAU-01



160 mm

€

16,40



5 KGAU-01

Dispensador cuchillas mini cutter



SQZ-MINI-BLADE



28 mm

€

5,22

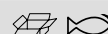

1 SQZ-MINI-BLADE

Navaja doble hoja mango de aluminio



KBTU-01

€ 31,44 5 KBTU-01

Navaja hoja intercambiable mango poliamida



KGSU-01

€ 15,43 5 KGSU-01

Display con 15 cuchillos multiusos de acero inoxidable con mango bi-componente



2446-BL

218 mm 102 mm € 9,37 15 2446-BL

Navaja deportiva plegable para corte de cuerda



KBSK-01

€ 20,01 5 KBSK-01

Cuchillo Laplander con mango verde bi-componente



2446-LAP

218 mm 102 mm € 8,34 15 2446-LAP
218 mm 102 mm 10,30 10 SB2446-LAP

SB: embalaje blister

Cuchillo de seguridad



2446-SAFE

215 mm 95 mm € 9,13 15 2446-SAFE

Navaja hoja intercambiable



KBSU-01

€ 20,01 5 KBSU-01

Cuchillo multiuso con hoja de acero inoxidable



2446

225 mm 100 mm € 11,09 15 2446

Cuchillo para lino



2446-LINO

180 mm 55 mm € 8,72 12 2446-LINO



Cuchillo electricista



2446-EL

		€		
32 mm	150 mm	9,38	12	2446-EL

Cuchillo pelacables para electricista - Para diestros



2446-ELR

		€		
34 mm	145 mm	9,38	12	2446-ELR

Cuchillo multiusos con hoja de acero inoxidable



1446

		€		
220 mm	100 mm	7,15	15	1446

Cuchillo mango robusto bi-componente, en blister



SB2446-EL

		€		
150 mm	32 mm	9,72	10	SB2446-EL

Cuchillo robusto multiusos



2446-OV

		€		
220 mm	100 mm	11,09	15	2446-OV

Display con 15 cuchillos multiusos de acero al carbono



1446-CS

		€		
218 mm	102 mm	7,50	15	1446-CS

Cuchillos pelacables de electricista - uso mano derecha



2446-ELL

		€		
34 mm	145 mm	9,38	12	2446-ELL

Cuchillo de electricista con funda



2446-EL-HELP

	€		
43 mm	10,25	12	2446-EL-HELP

Cuchillo de rescate flotante



1446-FLOAT

		€		
226 mm	102 mm	12,32	15	1446-FLOAT

Cuchillo flotante con mango fluorescente



1446-FLOAT-B

		€		
225 mm	100 mm	6,49	12	1446-FLOAT-B

Cubo para cuchillos 1446-CS



BUCKET-1446-CS

	€		
25 l	646,84	1	BUCKET - 1446-CS

Cuchillo punzón electricista



2820EK-01

		€		
25 mm	130 mm	6,02	12	2820EK-01

Cubo con 75 cuchillos 1446



BUCKET 1446

	€		
25 l	8,36	75	BUCKET 1446

BUCKET - EMPTY

1446x 75		

Cubo para cuchillos 1446-FLOAT



BUCKET-1446-FLOAT

	€		
25 l	796,14	1	BUCKET-1446-FLOAT

BUCKET - EMPTY

1446-FLOATx 75		

Cubo vacío



BUCKET-EMPTY

	€		
25 l	16,48	6	BUCKET - EMPTY

Cuchillo robusto multiusos



1446-OV

		€		
225 mm	100 mm	11,84	15	1446-OV

Navaja de electricista



2820EK

		€		
95 mm	205 mm	7,68	6	2820EK

Navaja para electricista, plegable, mango de madera



2820EF1

		€		
90 mm	200 mm	9,58	12	2820EF1



Navaja para electricista, plegable, mango de plástico



2820EF2

		€		
85 mm	195 mm	12,32	8	2820EF2

Multiherramienta



MTT151

	€		
150 mm	42,10	6	MTT151

Raspador ventanas cuerpo de metal



KRSS-01

	€		
80 g	6,71	10	KRSS-01

Navaja para electricista, plegable, mango de plástico



2820EF3

		€		
80 mm	170 mm	15,95	1	2820EF3

Multiherramienta con llavero



MTT121

	€		
110 mm	20,51	8	MTT121

Rasqueta de ventanas, cuerpo de plástico bicomponente



KBWS-01

	€		
70 g	6,02	10	KBWS-01

Navaja para electricista, plegable, mango de plástico



2820EF4

		€		
75-85 mm	170 mm	19,93	1	2820EF4

Multi herramienta 12 en 1 cuerpo de aluminio



MTT051

	€		
165 mm	25,13	6	MTT051



Mordazas y tornillos de banco

MORDAZAS DE BANCO

Mordaza Rápida



QCB

L	€		
456 mm	31,64	6	QCB-150
606 mm	33,92	6	QCB-300
756 mm	36,22	6	QCB-450
906 mm	38,88	4	QCB-600
1206 mm	42,50	4	QCB-900
1556 mm	50,99	8	QCB-1250

Mordaza Rápida



QCG

L	€		
380 mm	20,99	6	QCG-150
530 mm	23,89	6	QCG-300

Mordaza rápida



QC

X	L	€		
1	230 mm	3,15	12	QC-115A
2	230 mm	6,28	6	QC-115A-2P
1	305 mm	7,08	6	QC-150A
2	305 mm	14,17	6	QC-150A-2P
1	475 mm	11,15	6	QC-300A
2	475 mm	22,30	4	QC-300A-2P

-2P: 2 unidades

Mordazas



3066

L	W	€		
250 mm	90 mm	22,08	5	306601500
300 mm	90 mm	23,74	5	306602000
400 mm	90 mm	26,71	5	306603000
510 mm	90 mm	29,38	5	306604000

Mordazas



3067

L	W	€		
415 mm	125 mm	28,78	5	306703000
510 mm	125 mm	31,16	5	306704000
610 mm	125 mm	33,97	5	306705000
710 mm	125 mm	36,20	5	306706000
910 mm	125 mm	41,53	5	306708000
1115 mm	125 mm	47,19	5	306710000
1310 mm	125 mm	53,11	2	306712000
1610 mm	125 mm	60,82	2	306715000

Mordazas



3068

L	W	€		
430 mm	155 mm	51,48	5	306803000
535 mm	155 mm	54,90	5	306804000
640 mm	155 mm	58,04	2	306805000
730 mm	155 mm	60,74	2	306806000
820 mm	155 mm	66,59	2	306808000
1135 mm	155 mm	71,71	2	306810000
1335 mm	155 mm	76,09	2	306812000
1630 mm	155 mm	82,73	1	306815000
2130 mm	155 mm	90,85	1	306820000

Mordazas



3069

L	W	€		
430 mm	225 mm	82,77	2	306903000
540 mm	225 mm	85,88	2	306904000
638 mm	225 mm	88,99	2	306905000
730 mm	225 mm	91,98	2	306906000
932 mm	225 mm	98,06	2	306908000
1130 mm	225 mm	103,99	2	306910000

Mordaza con mango de plástico



420SH

L	W	€		
100 mm	50 mm	14,47	10	420SH-50-100
200 mm	50 mm	16,02	10	420SH-50-200
120 mm	60 mm	23,74	12	420SH-60-120
300 mm	60 mm	28,29	12	420SH-60-300
160 mm	80 mm	31,47	12	420SH-80-160
200 mm	100 mm	36,97	10	420SH-100-200
250 mm	120 mm	43,82	8	420SH-120-250
300 mm	120 mm	47,56	8	420SH-120-300
400 mm	120 mm	49,95	6	420SH-120-400
500 mm	120 mm	53,32	6	420SH-120-500
600 mm	120 mm	57,64	6	420SH-120-600
800 mm	120 mm	63,41	6	420SH-120-800
1000 mm	120 mm	67,07	6	420SH-120-1000
1250 mm	120 mm	76,20	6	420SH-120-1250
1500 mm	120 mm	79,99	6	420SH-120-1500
400 mm	140 mm	63,41	6	420SH-140-400
400 mm	175 mm	67,62	6	420SH-175-400

Mordaza muelle



420SC

	g	€		
25 mm	60 g	5,72	10	420SC-25
50 mm	120 g	8,53	5	420SC-50

Tornillo de banco, guía redonda



6010

	€		
80 mm	239,10	1	601000800
100 mm	318,78	1	601001000
125 mm	439,07	1	601001250
150 mm	624,07	1	601001500

Compatible con base giratoria 833SB Mordaza y husillo de repuesto 6010M y 6010H

Mordaza para tubos



833P

	€		
100 mm	33,25	1	833PJ-4
125 mm	41,32	1	833PJ-5
150 / 175 mm	41,32	1	833PJ-67

TORNILLOS DE BANCO

Tornillo de banco, guía cuadrada



834V

	€		
100 mm	291,57	1	834V-4
125 mm	391,80	1	834V-5
150 mm	495,07	1	834V-6
175 mm	643,88	1	834V-7

Tornillo lateral para regular la holgura Mordaza 6072M y husillo 6070H

Tornillo de sobremesa



834V-2

	€		
63 mm	126,25	1	834V-2

Husillo de repuesto para tornillo de banco 6072



6070H

	€		
100 mm	43,74	1	6070H1000
125 mm	62,25	1	6070H1250
150 mm	111,28	1	6070H1500
175 mm	143,14	1	6070H1750

Tornillo de banco, guía cuadrada



6072

	€		
100 mm	248,11	1	607201000
125 mm	347,35	1	607201250
150 mm	446,59	1	607201500
175 mm	595,46	1	607201750

Compatible con base giratoria 833SB

Mordazas con tornillos de repuesto para tornillo de banco 6072



6072M

	€		
100 mm 834V-4, 607201000	29,63	1	6072M1000
150 mm 834V-6, 607201500	45,95	1	6072M1500
175 mm 834V-7, 607201750	56,70	1	6072M1750

Mordazas de repuesto para tornillo de banco 6010



6010M



	€		
80 mm 601000800	24,82	1	6010M0800
100 mm 601001000	25,42	1	6010M1000
125 mm 834V-5, 607201250, 601001250	37,59	1	6010M1250
150 mm 601001500	46,01	1	6010M1500



Husillo y tuerca de repuesto para tornillo 6010





6010H

	€		
80 mm	48,68	1	6010H0800
100 mm	57,91	1	6010H1000
125 mm	78,95	1	6010H1250
150 mm	134,26	1	6010H1500

Mordazas de aluminio



833AJ

	€		
100 mm	36,92	1	833AJ-4
125 mm	38,34	1	833AJ-5
150 mm	39,91	1	833AJ-6

Mordazas y husillos de repuesto para tornillo de banco 834V-2





6040M/H

	€		
63 mm	20,76	1	6040M0630

Mordazas de fibra



833FJ





	€		
100 mm	42,15	1	833FJ-4
125 mm	43,41	1	833FJ-5
150 mm	45,13	1	833FJ-6

ACCESORIOS PARA TORNILLOS DE BANCO

Base giratoria para 6010,6072 y 834V



833SB

		€		
80 mm	100 mm	61,80	1	833SB-4
100 mm	125 mm	94,31	1	833SB-5
125 mm	150 mm	108,96	1	833SB-6
150 mm	175 mm	141,46	1	833SB-7



Martillos



MARTILLOS DE CARPINTERO

Martillo Carpintero ERGO™



ergo



529

	€		
450 g	38,64	4	529-16-L
450 g	40,72	4	529-16-XL
570 g	40,72	4	529-20-L
570 g	42,78	4	529-20-XL

Martillo de carpintero ERGO™



ergo



529S

	€		
450 g	39,73	4	529S-16-XL
570 g	41,74	4	529S-20-XL

Martillo de carpintero



429

	€		
230 g	18,45	4	429-8
370 g	26,85	4	429-13
450 g	29,27	4	429-16
570 g	30,12	4	429-20

Martillo de carpintero



428

	€		
450 g	27,36	4	428-16

Martillo de uña con mango de fibra de vidrio



428F

	€		
230 g	24,74	4	428F-8
370 g	27,52	4	428F-13
454 g	30,65	4	428F-16
567 g	32,62	4	428F-20
680 g	44,67	4	428F-24

Martillo de uña RIP con mango de fibra de vidrio



428S

	€		
454 g	30,65	4	428S-16
567 g	32,62	4	428S-20

Martillo de carpintero



427

	€		
370 g	21,09	4	427-13
680 g	32,60	4	427-24
230 g	19,15	4	427-8
450 g	29,09	4	427-16
570 g	30,08	4	427-20

Martillo de uña RIP con mango de madera



427S

	€		
454 g	22,45	4	427S-16
567 g	24,76	4	427S-20

Martillo de carpintero, mango madera



427

	€		
700 g	24,02	6	427-700

Martillo de carpintero, mango fibra de vidrio



428

	€		
700 g	31,10	6	428-700

EXTRACTORES DE CLAVOS

Extractor de clavos con mango de agarre cómodo de plástico termoinyectado



36

	€		
220 mm	45,63	5	36

Muelle interior patentado

MARTILLOS DE MECÁNICO

Martillo de bola



479

	€		
230 g	18,34	6	479-08
340 g	19,56	6	479-12
450 g	22,40	6	479-16
570 g	23,98	6	479-20
800 g	25,65	6	479-24
900 g	27,70	6	479-32

Martillo de bola con mango de fibra vidrio



479F

	€		
230 g	21,22	6	479F-08
340 g	22,51	6	479F-12
450 g	25,76	6	479F-16
570 g	27,58	6	479F-20
680 g	29,50	6	479F-24
900 g	31,85	6	479F-32

Martillo de cerrajero - tipo alemán DIN



481

	€		
100 g	12,38	6	481-100
200 g	13,89	6	481-200
300 g	16,38	6	481-300
400 g	18,10	6	481-400
500 g	20,82	6	481-500
800 g	27,77	6	481-800
1000 g	30,52	6	481-1000
1500 g	41,67	6	481-1500
2000 g	61,34	6	481-2000

Martillo alemán DIN con mango fibra de vidrio



481F

	€		
100 g	14,24	6	481F-100
200 g	15,97	4	481F-200

	€		
300 g	18,84	6	481F-300
400 g	20,82	6	481F-400
500 g	23,94	6	481F-500
800 g	31,94	6	481F-800
1000 g	35,09	6	481F-1000
1500 g	47,92	4	481F-1500
2000 g	70,55	4	481F-2000

Martillo para ribete - tipo francés



482

	€		
300 g	16,08	6	482-25
400 g	17,51	6	482-28
500 g	20,35	6	482-30
800 g	23,90	6	482-35
1000 g	26,50	6	482-40
1500 g	27,74	6	482-45

Martillo rivoir con mango fibra de vidrio



482F

	€		
300 g	18,50	4	482F-25
400 g	20,14	4	482F-28
470 g	23,41	6	482F-30
800 g	27,49	4	482F-35
1000 g	30,47	2	482F-40
1500 g	31,89	4	482F-45



Martillo Warrington



480

	€		
230 g	23,05	4	480-08
280 g	24,92	6	480-10
340 g	26,93	6	480-12
400 g	36,80	4	480-14
570 g	30,29	4	480-20

Martillo de carpintero



485W

	€		
650 g	28,74	6	485W-650
750 g	30,48	6	485W-750
	9,27	1	SH-485W
	7,37	1	SH-485W-PLATES

Martillo inglés



490

	€		
100 g	22,22	4	490-3.5

Martillo de bola



492

	€		
100 g	28,49	6	492-3.5

Martillo de ebanista



483

	€		
100 g	9,93	6	483-16
160 g	11,05	6	483-20
200 g	11,96	6	483-22
300 g	13,48	6	483-25
400 g	14,98	6	483-28

Maceta



484

	€		
1000 g	30,48	6	484-1000
1250 g	34,48	6	484-1250
1500 g	39,01	6	484-1500
2000 g	42,98	4	484-2000

MARTILLOS PARA CONSTRUCCIÓN

Martillo de carpintero



485

	€		
600 g	31,37	6	485

Martillo de ebanista con mango fibra de vidrio



483F

	€		
100 g	11,42	6	483F-16
160 g	12,71	6	483F-20
200 g	13,76	6	483F-22
300 g	15,50	6	483F-25
400 g	17,22	6	483F-28
500 g	18,81	4	483F-30

Maceta con mango fibra de vidrio



484F

	€		
1000 g	35,05	6	484F-1000
1250 g	39,65	6	484F-1250
1500 g	44,86	6	484F-1500
2000 g	49,42	4	484F-2000

Maceta de albañil



407

	€		
700 g	15,41	5	407-700
1000 g	17,11	6	407-1000
1400 g	19,13	6	407-1400

Maceta mango fibra de vidrio



407F

	€		
700 g	17,91	6	407F-700
1000 g	19,76	6	407F-1000
1400 g	22,56	6	407F-1400

Maza cuadrada, mango madera



488

	€		
2000 g	35,22	2	488-2000
3000 g	42,58	2	488-3000
4000 g	49,35	2	488-4000
5000 g	59,03	2	488-5000
6000 g	64,87	1	488-6000

Maza cuadrada, mango fibra de vidrio



488F

	€		
2000 g	39,67	2	488F-2000
3000 g	46,29	2	488F-3000
4000 g	52,40	2	488F-4000
5000 g	62,21	4	488F-5000
6000 g	67,52	2	488F-6000

Martillo de albañil



486W

	€		
500 g	23,05	4	486W-500
600 g	23,75	4	486W-600
	8,68	1	SH-486W

Piqueta 700g, mango madera



486-700

	€		
700 g	22,92	6	486-700

Piqueta 700g, mango fibra de vidrio



486F

	€		
700 g	29,37	6	486F-700

Martillo de albañil



486

	€		
600 g	30,26	4	486

Fijas de albañil



4401

	€		
255 mm	6,03	10	440102500
300 mm	6,34	10	440103000



Mangos de madera de repuesto



WSH

	€		
407	4,50	1	SH-407
491-3000 & 491-4000	18,27	12	SH-491-34
491-5000 & 491-6000	29,06	12	SH-491-56
488-2000	13,01	10	SH-488-2000
488-3000, 488-4000	18,84	10	SH-488-34
488-5000, 488-6000	20,57	10	SH-488-56
427-700	5,97	10	SH-427-700
486-700, 495-500, 495-600, 493-500, 493-600	5,97	10	SH-486-493-495

Alcotana pala-hacha, mango fibra de vidrio



493F

	€		
500 g	27,44	6	493F-500
600 g	29,85	1	493F-600

Martillo hacha



494

	€		
600 g	31,21	4	494-600

Mangos de fibra de vidrio de repuesto



FSH

	€		
488f-2000	16,05	10	SH-488F-2000
488F-3000 & 488F-4000	19,90	1	SH-488F-34
488F-5000 & 488F-6000	21,23	1	SH-488F-56
428-700	8,62	10	SH-428-700
486F-700, 495F-500, 495F-600, 493F-500, 493F-600	8,62	10	SH-486F493F495F

Alcotana pala-pico, mango madera



495

	€		
500 g	23,35	6	495-500
600 g	24,34	6	495-600

Martillo anti-rebote



3625AR

	€		
550 g	34,29	34	3625AR-35
1430 g	56,64	18	3625AR-50
1550 g	73,69	12	3625AR-60

MARTILLOS ESPECIALES

Alcotana pala-hacha, mango madera



493

	€		
500 g	22,88	6	493-500
600 g	24,54	6	493-600

Alcotana pala-pico, mango fibra de vidrio



495F

	€		
500 g	26,72	6	495F-500
600 g	29,37	1	495F-600

Taco de repuesto para martillos 3625AR



3625ARL

	€		
35 mm	3625AR-35	1,40	6 3625ARL-35
50 mm	3625AR-50	5,54	6 3625ARL-50
60 mm	3625AR-60	9,27	6 3625ARL-60

Mango de repuesto para martillos 3625AR



3625ARLH

	L	€		
3625AR-35	290 mm	4,60	80	3625ARLH-35
3625AR-60	300 mm	4,86	50	3625ARLH-50
3625AR-60	390 mm	5,12	16	3625ARLH-60

Maza con pico



491

	€		
3000 g	36,89	4	491-3000
4000 g	41,08	4	491-4000
5000 g	48,55	4	491-5000
6000 g	53,67	4	491-6000

MARTILLOS Y MAZAS BLANDOS

Martillo de plástico Polyflex



3625Y

g	€		
120 g	42,22	6	3625Y-22
225 g	60,56	6	3625Y-32
372 g	83,69	6	3625Y-40
484 g	117,95	6	3625Y-50

Martillo anti-rebote



3625PU

	€		
300 g	30,65	12	3625PU-30
790 g	50,59	6	3625PU-50
1080 g	76,31	6	3625PU-60

Mango irrompible



489-1100/489-1800

	€		
1100 g	111,08	8	489-1100
1800 g	111,43	8	489-1800

Par de bocas de repuesto para 3625Y



3625YL

		€		
3625Y-22	22 mm	17,04	20	3625YL-22
3625Y-32	32 mm	29,59	20	3625YL-32
3625Y-40	40 mm	52,67	20	3625YL-40
3625Y-50	50 mm	87,32	20	3625YL-50

Martillo anti-rebote



3625PU-105

	g	€		
5000 g	5600 g	250,37	4	3625PU-105

Maza de seguridad



489-2700/489-5400

	€		
2700 g	209,03	4	489-2700
3600 g	249,00	4	489-3600
4500 g	269,65	4	489-4500
5400 g	299,95	4	489-5400

Martillo de plástico Superflex



3625N

g	€		
120 g	44,91	6	3625N-22
225 g	48,51	6	3625N-32
372 g	81,63	6	3625N-40
484 g	98,91	6	3625N-50



Par de bocas de repuesto para 3625N



3625NL

			€		
3625N-22	22 mm	12,59	20	3625NL-22	
3625N-32	32 mm	21,46	20	3625NL-32	
3625N-40	40 mm	37,29	20	3625NL-40	
3625N-50	50 mm	62,26	20	3625NL-50	

Maza mango madera, boca de nylon



3625W

g	€		
150 g	11,01	120	3625W-22
250 g	15,74	1	3625W-28
490 g	19,83	1	3625W-35
1050 g	28,94	1	3625W-44
1470 g	55,66	12	3625W-55

WL: Tacos de recambio WLH: Mango de repuesto

Bocas de repuesto para 3625W y 3625S



3625WL

			€		
3625W-22	22 mm	4,19	10	3625WL-22	
3625W-28, 3625S-28	28 mm	4,65	10	3625WL-28	
3625W-35, 3625S-35	35 mm	5,66	10	3625WL-35	
3625W-44, 3625S-44	44 mm	6,19	10	3625WL-44	
3625W-55	55 mm	8,19	6	3625WL-55	

Mango de repuesto para martillos 3625W



3625WLH

		€		
3625W-22	3,39	50	3625WLH-22	
3625W-28	3,57	50	3625WLH-28	
3625W-35	3,83	80	3625WLH-35	
3625W-44	4,48	50	3625WLH-44	
3625W-55	4,74	16	3625WLH-55	

Martillo boca nylon - Mango de acero



3625S

g	€		
350 g	23,50	50	3625S-28
610 g	31,34	30	3625S-35
1100 g	44,37	18	3625S-44

Maza de goma negra



3625RM

g	€		
290 g	10,91	50	3625RM-55
460 g	11,78	40	3625RM-65
660 g	14,12	30	3625RM-75
850 g	17,15	20	3625RM-90

Maceta de cobre



4130

	€		
500 g	63,78	12	413005000
1000 g	105,08	12	413010000
1500 g	138,00	12	413015000
2000 g	180,83	6	413020000
3000 g	183,55	1	413030000
4000 g	243,68	1	413040000



Herramientas forestales y de tala de árboles



HACHAS, ALCOTANAS Y MAZAS

Hachas con mango de madera



HUS

mm	g	€		
380 mm	770 g	33,53	4	HUS-0.6-380
500 mm	1080 g	37,50	4	HUS-0.8-500

Hacha tipo Alemán



HGPS

mm	g	€		
380 mm	944 g	32,95	4	HGPS-0.8-380-WB
400 mm	1130 g	34,75	4	HGPS-1.0-400-WB
360 mm	790 g	23,27	10	HGPS-0.6-360
380 mm	1020 g	28,45	4	HGPS-0.8-380
400 mm	1260 g	31,83	4	HGPS-1.0-400

Hachas con mango de madera



HUS-1.0-650

mm	g	€		
650 mm	1380 g	42,20	4	HUS-1.0-650

Hacha con mango en fibra de vidrio



HFGPS

mm	g	€		
380 mm	1010 g	45,49	4	HFGPS-0,7-400FG

Hacha tipo Alemán



FGS-810

mm	g	€		
800 mm	2260 g	55,09	4	FGS-1.6-810
800 mm	2460 g	59,94	4	FGS-1.8-810

Hacha tipo Canadiense, mango de nogal



FCP

mm	g	€		
800 mm	2500 g	81,88	4	FCP-1.8-810
850 mm	3000 g	91,09	2	FCP-2.3-860

Hacha tipo Alemán



FGS

mm	g	€		
700 mm	1730 g	51,68	4	FGS-1.25-700-WB
810 mm	2210 g	57,90	4	FGS-1.6-810-WB
600 mm	1400 g	46,39	4	FGS-1.0-600
700 mm	1850 g	48,89	4	FGS-1.25-700

Hacha con mango en fibra de vidrio



FFSS

mm	g	€		
900 mm	2400 g	67,99	4	FFSS-1.5-900FG

Hacha



SUS

mm	g	€		
800 mm	2600 g	83,51	4	SUS-2.0-800

Hacha tipo Canadiense, Mango de nogal



MCP

mm	g	€		
800 mm	3280 g	73,40	2	MCP-2.5-810

Maza con mango en fibra de vidrio



LS-MASSE

mm	g	€		
900 mm	4800 g	57,46	2	LS-MASSE-4FG
900 mm	4640 g	46,54	2	LS-MASSE-4

Fibra de vidrio

Maza con mango en fibra de vidrio



LS-MASSE-TR

↔ L	g	€	📦	🐟
900 mm	4840 g	63,18	2	LS-MASSE-TR-4FG

Mango de repuesto para hachas



SH

↔ L	€	📦	🐟
800 mm	27,06	1	SH-FCS-810
900 mm	31,07	1	SH-FCS-860
600 mm	21,44	1	SH-FGS-600
700 mm	23,40	12	SH-FGS-700
800 mm	27,87	1	SH-FGS-800
900 mm	20,22	1	SH-FGS-1.8-810
375 mm	19,33	1	SH-HFGPS-400FG
400 mm	17,15	1	SH-HGPS-400
900 mm	20,89	12	SH-MES-F-900
360 mm	14,49	12	SH-HGPS-360
380 mm	15,54	1	SH-HGPS-380
380 mm	15,54	1	SH-HUS-380
500 mm	20,39	1	SH-HUS-500
650 mm	23,05	1	SH-HUS-650
900 mm	26,82	12	SH-MES-900
915 mm	40,15	12	SH-MES-900FG
800 mm	27,87	12	SH-SUS-800
800 mm	27,87	1	SH-MCS-800
905 mm	33,63	1	SH-FCP-860

FB: Fibra Vidrio

Hacha



LS/MES

↔ L	g	€	📦	🐟
900 mm	3390 g	49,31	2	LS-MERLIN-2.5
900 mm	3330 g	63,65	2	LS-MERLIN-2.5FG
900 mm	3580 g	53,78	2	MES-3.0-900

FG: Fibra de vidrio

Hacha rompedora



MES

↔ L	g	€	📦	🐟
900 mm	4250 g	59,98	2	MES-3.5-900
900 mm	4310 g	77,08	2	MES-3.5-900FG

Fibra de vidrio

Pico de hacha



PAGO-2.0-900FG

↔ L	g	€	📦	🐟
900 mm	3000 g	74,97	1	PAGO-2.0-900FG

Cabeza para pico



PAGO

↔ L	g	€	📦	🐟
450 mm	2000 g	31,19	1	PAGO-2.0

Mangos de repuesto para pico de hacha



SH-PAGO

↔ L	g	€	📦	🐟
900 mm	690 g	20,57	1	SH-PAGO-900
920 mm	1030 g	47,59	1	SH-PAGO-900FG

Fibra de vidrio

CUÑAS

Cuñas de Tumba



LS-COIN

↔ L	g	€	📦	🐟
260 mm	295 g	31,49	2	LS-COIN 26 CM
190 mm	170 g	29,31	4	LS-COIN 19 CM

Cuñas rompedoras



WT

↔ L	g	€	📦	🐟
220 mm	2000 g	57,94	4	W-T-2.0

Cuñas rompedoras



WS

↔ L	g	€	📦	🐟
220 mm	1500 g	20,13	4	W-S-1.5
250 mm	2000 g	25,65	4	W-S-2.0
260 mm	2500 g	31,83	4	W-S-2.5





BAHCO



Cinceles y punteros de chapista



CINCELES DE CHAPISTA

Cinceles de chapista con mango octogonal y revestimiento de plástico



3656

L	W	€	PK	Icon
129 mm	12 mm	9,59	50	3656-125
155 mm	16 mm	13,54	50	3656-150
178 mm	19.5 mm	9,59	1	3656-175

Cortafíos plano



3640

L	W	€	PK	Icon
150 mm	18 mm	16,44	25	3640-150-C
200 mm	22 mm	18,94	25	3640-200-C
250 mm	28 mm	22,48	20	3640-250-C
300 mm	26 mm	28,80	25	3640-300-C

Buril



3745

L	Ø	€	PK	Icon
150 mm	6 mm	13,64	50	3745-150
175 mm	7 mm	17,43	25	3745-175
200 mm	8 mm	18,49	20	3745-200
250 mm	9 mm	26,05	10	3745-250

Cortafíos plano



3740

L	€	PK	Icon
100 mm	9,17	50	3740-100
125 mm	11,05	50	3740-125
150 mm	12,63	50	3740-150
175 mm	13,37	25	3740-175
200 mm	14,50	25	3740-200
250 mm	15,26	10	3740-250
300 mm	16,32	10	3740-300

Cinzel con cabeza reforzada



3756

L	W	€	PK	Icon
125 mm	10 mm	6,85	50	3756-125
150 mm	12 mm	8,50	50	3756-150

Cinzel con vástago octogonal



3749

L	Ø	€	PK	Icon
125 mm	10 mm	6,85	50	3749-125

Cortafíos plano con clip para colgar



SB-3740

L	€	PK	Icon
125 mm	11,52	87	SB-3740-125
150 mm	13,11	25	SB-3740-150
175 mm	14,67	25	SB-3740-175
200 mm	15,27	25	SB-3740-200
250 mm	16,11	25	SB-3740-250
300 mm	16,91	25	SB-3740-300

Buriles con mango octogonal plano y revestimiento de plástico



3649

L	Ø	€	PK	Icon
128 mm	12 mm	9,59	50	3649-125

Cortafíos para grietas



3750

L	W	€	PK	Icon
240 mm	26 mm	18,07	25	3750

Cinzel de albañil



3736M

L	€		
200 mm	15,78	30	3736M-200
250 mm	20,74	25	3736M-250
300 mm	27,49	10	3736M-300
400 mm	36,25	10	3736M-400

Cinzel



8740

L	€		
200 mm	9,96	5	874002000
250 mm	10,91	5	874002500
300 mm	12,31	5	874003000
350 mm	13,64	5	874003500
400 mm	17,15	5	874004000
500 mm	20,45	5	874005000

Juego de 6 buriles



3736S/6

g	€		
840 g	60,37	5	3736S/6

3735-4-120, 3735-5-150

3733-3

3749-125

3756-125, 3756-150

Cinzel de punta



3739-250 / -400

L	Ø	€		
250 mm	16 mm	20,84	25	3739-250
300 mm	18 mm	27,60	10	3739-300
400 mm	18 mm	36,45	10	3739-400

CINCELES DE CHAPISTA CON PROTECCION

Cortafíos con cabeza reforzada



3750H

L	€		
240 mm	26,32	25	3750H

Cinzel de albañil con cabeza reforzada



3736MH

L	€		
250 mm	28,58	10	3736MH-250
300 mm	35,13	10	3736MH-300
400 mm	43,96	5	3736MH-400

Cinzel de punta con cabeza reforzada



3739H

L	Ø	€		
250 mm	16 mm	28,74	15	3739H-250
300 mm	18 mm	35,32	10	3739H-300
400 mm	18 mm	44,18	10	3739H-400

CINCELES DE CHAPISTA (REAFILABLES)

Cortafíos



8741

L	€		
200 mm	15,96	6	874102000
250 mm	16,80	5	874102500
300 mm	17,95	5	874103000
350 mm	19,20	4	874103500
400 mm	21,97	5	874104000

Puntero Octogonal



8746

L	Ø	€		
200 mm	14 mm	8,34	5	874602000
250 mm	14 mm	9,26	5	874602500
300 mm	16 mm	10,41	5	874603000
350 mm	16 mm	11,84	5	874603500
400 mm	18 mm	14,17	5	874604000



Cinzel de electricista



8760

L	€			
200 mm	8,98	10	876002000	
250 mm	9,37	5	876002500	

Cinzel de chapista



8770

L	€			
240 mm	16,37	25	877002400	

CINCELES DE CHAPISTA - ACCESORIOS

Mango para formones



8749

Ø	€			
16x16 mm	5,31	1	874916X16	
18x18 mm	5,31	1	874918X18	
23x13 mm	5,31	1	874923X13	
26x7 mm	5,31	1	874926X7	

PUNTEROS

Granete con protector para la mano



3643

Ø	L	€			
3 mm	100 mm	17,89	50	3643-100	
4 mm	120 mm	20,14	50	3643-120	
5 mm	120 mm	25,75	50	3643-150	

Granete color cobre, mango octogonal



3735

Ø	L	€			
4 mm	120 mm	5,32	50	3735-4-120	
5 mm	120 mm	6,56	50	3735-5-120	
5 mm	150 mm	8,73	50	3735-5-150	

Granete con mango hexagonal



3735N

Ø	L	€			
2 mm	100 mm	5,54	10	3735N-2-100	
4 mm	120 mm	6,16	10	3735N-4-120	
5 mm	120 mm	6,96	10	3735N-5-120	
6 mm	150 mm	7,57	10	3735N-6-150	
8 mm	150 mm	7,57	10	3735N-8-150	
2 mm	100 mm	6,33	1	SB-3735N-2-100	
4 mm	120 mm	6,93	60	SB-3735N-4-120	
5 mm	120 mm	7,74	1	SB-3735N-5-120	
6 mm	150 mm	8,36	1	SB-3735N-6-150	
8 mm	150 mm	8,36	1	SB-3735N-8-150	

SB: Clip para colgar

Juego de 4 granetes cromados



3735NS/4

g	€			
340 g	27,62	25	3735NS/4	

3735N-6-150, 3735N-8-150, 3735N-2-100, 3735N-4-120

Punzón automático



1157

Ø	L	€			
2 mm	130 mm	13,82	60	1157	

Botador con protector para la mano



3644

Ø	L	€			
2 mm	120 mm	15,00	50	3644-120	
3 mm	125 mm	17,70	50	3644-125	
4 mm	130 mm	21,40	50	3644-130	
4 mm	150 mm	23,01	50	3644-150	
5 mm	165 mm	23,72	50	3644-165	
6 mm	180 mm	31,70	50	3644-180	
8 mm	200 mm	35,93	50	3644-200	

Botador con manguito guía



3659

Ø	L	€	Icon 1	Icon 2
0.9 mm	70 mm	12,13	5	3659-0.9
1.4 mm	81 mm	12,35	5	3659-1.4
1.8 mm	84 mm	12,70	5	3659-1.8
2.4 mm	92 mm	13,65	5	3659-2.4
2.8 mm	95 mm	14,39	5	3659-2.8
3.4 mm	97 mm	14,69	5	3659-3.4
3.9 mm	100 mm	13,54	5	3659-3.9
5.9 mm	100 mm	14,96	5	3659-6.0

Botador con protector para la mano



3658A

Ø	L	€	Icon 1	Icon 2
2 mm	150 mm	18,17	125	3658A-2
3 mm	150 mm	18,36	125	3658A-3
4 mm	150 mm	18,36	125	3658A-4
5 mm	150 mm	18,43	125	3658A-5
6 mm	150 mm	18,43	125	3658A-6
8 mm	150 mm	18,43	50	3658A-8

Ø	L	€	Icon 1	Icon 2
8 mm	150 mm	7,57	10	3734N-8-150
9 mm	150 mm	7,57	10	3734N-9-150
10 mm	150 mm	7,57	10	3734N-10-150
2 mm	150 mm	6,92	1	SB-3734N-2-150
3 mm	150 mm	6,92	1	SB-3734N-3-150
4 mm	150 mm	7,12	60	SB-3734N-4-150
5 mm	150 mm	7,12	1	SB-3734N-5-150
6 mm	150 mm	8,36	60	SB-3734N-6-150
7 mm	150 mm	8,36	1	SB-3734N-7-150
8 mm	150 mm	8,36	1	SB-3734N-8-150
10 mm	150 mm	8,36	1	SB-3734N-10-150

Botador cónico color cobre mango octogonal



3733

Ø	L	€	Icon 1	Icon 2
2 mm	120 mm	5,05	50	3733-2
3 mm	120 mm	5,05	50	3733-3
4 mm	120 mm	4,95	50	3733-4
5 mm	120 mm	4,95	50	3733-5
6 mm	120 mm	4,95	50	3733-6

Botador cilíndrico color cobre mango octogonal



3734

Ø	L	€	Icon 1	Icon 2
2 mm	150 mm	8,54	50	3734-2
3 mm	150 mm	8,54	50	3734-3
4 mm	150 mm	8,54	50	3734-4
5 mm	150 mm	8,54	50	3734-5
6 mm	150 mm	8,54	50	3734-6
8 mm	150 mm	8,73	50	3734-8

Juego de 6 botadores con protector para la mano



3646/6

g	€	Icon 1	Icon 2
730 g	142,82	25	3646/6

3646-115, 3646-125, 3646-150, 3646-165, 3646-180, 3646-200



Botador con protector para la mano



3646

Ø	L	€	Icon 1	Icon 2
2 mm	115 mm	17,89	250	3646-115
3 mm	125 mm	17,89	250	3646-125
4 mm	150 mm	17,97	125	3646-150
5 mm	165 mm	18,14	125	3646-165
6 mm	180 mm	20,75	50	3646-180
8 mm	200 mm	24,92	50	3646-200

Botador cilíndrico mango hexagonal



3734N

Ø	L	€	Icon 1	Icon 2
2 mm	150 mm	6,14	10	3734N-2-150
3 mm	150 mm	6,14	10	3734N-3-150
4 mm	150 mm	6,34	10	3734N-4-150
5 mm	150 mm	6,34	10	3734N-5-150
6 mm	150 mm	7,57	10	3734N-6-150
7 mm	150 mm	7,57	10	3734N-7-150

Juego de herramientas, 6 piezas



3654R

g	€	Icon 1	Icon 2
870 g	158,47	1	3654R

2 x 3656, 1 x 3649, 2 x 3644, 1 x 3643



Juego de 8 botadores



3659/8

	€		
270 g	113,78	1	3659/8

3659-0.9, 3659-1.4, 3659-1.8, 3659-2.4, 3659-2.8, 3659-3.4, 3659-3.9, 3659-6.0

Juego de 6 botadores con protector para la mano



3658A/6

	€		
560 g	135,80	30	3658A/6

3658A-2, 3658A-3, 3658A-4, 3658A-5, 3658A-6, 3658A-8

Juego de 9 botadores cilíndricos 2-10mm



3734NS/9

	€		
750 g	62,16	10	3734NS/9

3734N-10-150, 3734N-9-150, 3734N-8-150, 3734N-7-150, 3734N-6-150, 3734N-5-150, 3734N-4-150, 3734N-3-150, 3734N-2-150

Juego de 6 botadores



3734S/6

	€		
720 g	67,22	5	3734S/6

3734-2, 3734-3, 3734-4, 3734-5, 3734-6, 3734-8

Juego de 8 botadores en estuche de plástico



3659/8T

	€		
170 g	108,85	1	3659/8T

3659-0.9, 3659-2.8, 3659-2.4, 3659-1.8, 3659-6.0, 3659-3.9, 3659-3.4, 3659-1.4

Botador con protector para la mano en blister



3732

		€		
2 mm	125 mm	5,94	60	SB-3732-2-125
2.5 mm	125 mm	5,94	60	SB-3732-2.5-125
3.2 mm	125 mm	5,94	60	SB-3732-3.2-125
4 mm	125 mm	5,94	1	SB-3732-4-125

Juego de herramientas, 10 piezas



3656/10

	€		
1260 g	262,02	1	3656/10

3 x 3656, 1 x 3644, 1 x 3649, 1 x 3643 en 3 x 3646

Juego de 5 botadores cónicos dorados



3733S/5

	€		
410 g	26,81	25	3733S/5

3733-4, 3733-2, 3733-6
3733-8, 3733-10

Sacabocados



B400

	€		
2 mm	11,33	1	B400.002
3 mm	11,33	1	B400.003
4 mm	11,33	1	B400.004
5 mm	11,33	1	B400.005
6 mm	11,33	1	B400.006
7 mm	11,33	1	B400.007

Ø	€		
8 mm	11,33	1	B400.008
9 mm	11,33	1	B400.009
10 mm	11,33	1	B400.010
11 mm	14,26	1	B400.011
12 mm	14,26	1	B400.012
13 mm	14,26	1	B400.013
14 mm	14,26	1	B400.014
15 mm	14,26	1	B400.015
16 mm	14,26	1	B400.016
17 mm	14,26	1	B400.017
18 mm	14,26	1	B400.018
19 mm	14,26	1	B400.019
20 mm	14,26	1	B400.020
21 mm	18,90	1	B400.021
22 mm	18,90	1	B400.022
23 mm	18,90	1	B400.023
24 mm	18,90	1	B400.024
25 mm	18,90	1	B400.025
26 mm	18,90	1	B400.026
27 mm	18,90	1	B400.027
28 mm	18,90	1	B400.028
29 mm	18,90	1	B400.029
30 mm	18,90	1	B400.030
31 mm	24,41	1	B400.031
32 mm	24,41	1	B400.032
33 mm	24,41	1	B400.033
34 mm	24,41	1	B400.034
35 mm	24,41	1	B400.035
36 mm	24,41	1	B400.036
37 mm	24,41	1	B400.037
38 mm	24,41	1	B400.038
39 mm	24,41	1	B400.039
40 mm	24,41	1	B400.040
41 mm	28,71	1	B400.041
42 mm	28,71	1	B400.042
43 mm	28,71	1	B400.043
44 mm	28,71	1	B400.044
45 mm	28,71	1	B400.045
46 mm	28,71	1	B400.046
47 mm	28,71	1	B400.047
48 mm	28,71	1	B400.048
49 mm	28,71	1	B400.049
50 mm	28,71	1	B400.050

Tapón sacabocados mango 2 a 30 mm



WPH3-30

L	g	€		
185 mm	500 g	44,71	1	WPH 3-30

Juego sacabocados, 16 piezas



400.003.030

Ø	€		
3-30 mm	214,41	1	400.003.030

Tapón sacabocados mango 2 a 50 mm



WPH2-50

L	g	€		
180 mm	761 g	136,99	1	WPH 2-50

Juego punzones 2 a 50 mm



400.002.050

Ø	€		
2-50 mm	494,20	1	400.002.050

Tapón sacabocados mango 2 a 20 mm



WPH3-20

L	g	€		
95 mm	290 g	33,29	1	WPH 3-20

Juego sacabocados, 11 piezas



400.003.020

Ø	€		
3-20 mm	87,06	1	400.003.020

Sacabocados revólver



2635

L	€		
245 mm	60,64	1	2635



Sacabocados revólver



4630

	€		
220 mm	23,60	1	4630

Perforador de chapa métrico redondo



6900

	€		
16 mm	60,64	1	690000160
20 mm	76,02	1	690000200
22 mm	76,02	1	690000220
25 mm	86,33	1	690000250
30 mm	93,45	1	690000300
32 mm	93,45	1	690000320
35 mm	119,67	1	690000350
40 mm	128,29	1	690000400
50 mm	157,43	1	690000500
63 mm	364,89	1	690000630

Juego 7 perforadores chapa



6907

	€		
4080 g	986,68	1	69079019P

690000160, 690000250, 690000200, 690000320, 690000500, 690000400, 690000630

690900120, 690900080, 690900100, 690900200, 690900140

Tornillos de repuesto para perforadores de chapa



6909

	€		
16 mm	12,66	4	690900080
20-25 mm	18,69	4	690900100
30-35 mm	18,69	2	690900120
40-50 mm	27,88	2	690900140
63 mm	55,09	1	690900200

PUNTEROS CON MANGO BIMATERIAL

Granete con punta



SB3755BM

		€		
4 mm	165 mm	10,29	1	SB3755BM-4
6 mm	185 mm	11,45	5	SB3755BM-6

SB: Embalaje en blister

Granete cilíndrico



SB3734BM

		€		
10 mm	180 mm	14,52	5	SB3734BM-10
3 mm	155 mm	12,68	5	SB3734BM-3
4 mm	165 mm	13,03	5	SB3734BM-4
5 mm	165 mm	13,43	5	SB3734BM-5
6 mm	185 mm	13,84	5	SB3734BM-6
8 mm	185 mm	14,10	5	SB3734BM-8

SB: Embalaje en blister

Bandeja modular 7 botadores cilíndricos



3734BMS/7

	€		
900 g	97,41	1	3734BMS/7

CINCELES DE CHAPISTA CON MANGO BIMATERIAL

Cinzel con protector 15mm



SB3654BM

	€		
155 mm	13,96	5	SB3654BM-15
185 mm	14,83	5	SB3654BM-20

SB: Embalaje en blister

Bandeja modular con 7 cinceles



3654BMS/7

	€		
920 g	99,95	1	3654BMS/7

3734BM-2, 3734BM-4, 3734BM-5, 3734BM-6, 3654BM-15, 3654BM-20, 3755BM-6



Palanca desencofrar



BARRAS DESECOFRADORAS

Palanca ajustable de 260 mm



APB260

L	g	€	Paquete	Modelo
260 mm	410 g	62,12	10	APB260

Palanca ajustable de 360 mm



APB360

L	g	€	Paquete	Modelo
360 mm	543 g	62,77	10	APB360

Palanca Crowfoot - Acabado preciso 10"



CFP250

L	€	Paquete	Modelo
250 mm	23,78	6	CFP250

Barra desenganchadora premium



WBP

Ø	L	€	Paquete	Modelo
14 mm	346 mm	37,53	20	WBP300
16 mm	487 mm	41,41	12	WBP500
17 mm	625 mm	54,36	12	WBP625
17 mm	704 mm	60,82	10	WBP710
20 mm	890 mm	89,30	6	WBP900

Barra desenganchadora



WBB

L	Ø	€	Paquete	Modelo
391 mm	14 mm	19,41	10	WBB400
500 mm	16 mm	20,71	10	WBB500
595 mm	18 mm	22,00	10	WBB600
680 mm	18 mm	23,94	6	WBB700
810 mm	18 mm	27,18	6	WBB800
1000 mm	20 mm	41,55	4	WBB1000
1200 mm	20 mm	48,08	4	WBB1200
1500 mm	22 mm	64,08	4	WBB1500

Barra desenganchadora plana



WBF380

L	Ø	€	Paquete	Modelo
374 mm	35 mm	20,71	12	WBF380

Mini palanca plana



WBMF190

Ø	L	€	Paquete	Modelo
18 mm	188 mm	10,29	24	WBMF190

Display con 15 barras desenganchadoras WBMF190



WBMF190IP

g	€	Paquete	Modelo
39 g	10,62	15	WBMF190IP

WBMF190x 15

Juego 3 palancas premium: WBP300, WBF380 y WBMF190



WBP-3P-3FMF

g	€	Paquete	Modelo
1600 g	67,17	1	WBP-3P-3FMF

WBP300

WBF380

WBMF190

Juego 3 palancas premium: WBP625, WBF380 y WBMF190



WBP-3P-6FMF

	€		
3000 g	77,00	1	WBP-3P-6FMF

WBP625	
WBF380	
WBMF190	

Juego 3 palancas premium: WBP300, WBP625 y WBP900



WBP-3P-963

	€		
4740 g	164,68	1	WBP-3P-963

WBP900, WBP625, WBP300	
------------------------	--

Juego de 3 palancas premium octogonales para mayor fuerza



WBP-3P-96F

	€		
6000 g	148,09	1	WBP-3P-96F

WBP900, WBP625	
WBF380	





BAHCO



Herramientas para plantación y cultivo



PEQUEÑAS HERRAMIENTAS DE JARDINERÍA

Azada 



P262
 315 mm € 16,32 10 P262

Lanza azuela 



P278
 455 mm € 21,16 5 P278

Transplantador 



P263
 370 mm € 18,36 10 P263

Azuela 



P272
 450 mm € 20,87 5 P272

Azada horquilla 



P267
 320 mm € 16,91 10 P267

Cultivador 



P264
 315 mm € 16,45 10 P264

Lanza Azuela 



P268
 320 mm € 16,91 10 P268

Azuela horquilla 



P277
 455 mm € 21,29 5 P277

Cultivador 



P274
 470 mm € 20,28 5 P274

Rastrillo



P276

	€		
450 mm	20,81	5	P276

Tridente



P270

	€		
305 mm	15,77	10	P270

Rastrillo



P266

	€		
335 mm	16,25	10	P266

Plantador de bulbos



P241

	€		
340 g	12,68	5	P241

Escarvador



P269

	€		
315 mm	13,28	10	P269



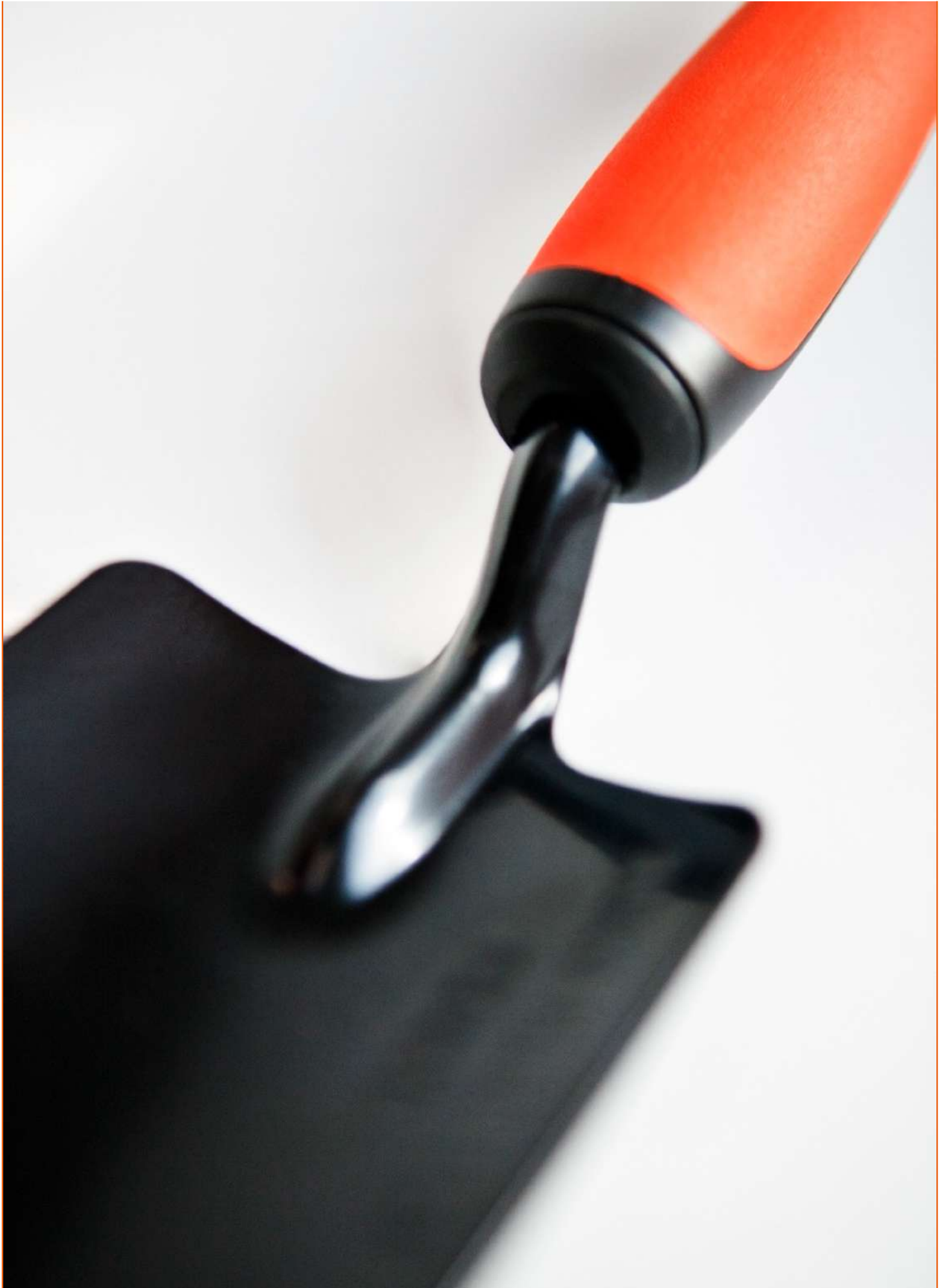

BAHCO



Herramientas de poda



TIJERAS DE PODA UNA MANO

Podadera ergonómica de mango fijo



ergo



PX

	€		
15 mm	56,50	2	PX-S1
20 mm	56,50	2	PX-S2
15 mm	56,50	2	PX-M1
20 mm	56,50	2	PX-M2
20 mm	56,50	2	PX-M2-L
30 mm	56,50	2	PX-M3
20 mm	56,50	2	PX-L2
30 mm	56,50	2	PX-L3

L: Zurdos

Podadera ergonómica de mango rotativo



ergo



PXR

	€		
20 mm	81,81	2	PXR-S2-L
15 mm	81,81	2	PXR-S1
20 mm	81,81	2	PXR-S2
15 mm	81,81	2	PXR-M1
20 mm	81,81	2	PXR-M2
20 mm	81,81	2	PXR-M2-L
30 mm	81,81	2	PXR-M3
20 mm	81,81	2	PXR-L2

L: Zurdos

Cabeza de corte pre-ensamblada para PX-PXR



R801P-R804P

	€		
1	38,08	1	R801P
2	38,37	1	R802P
3	38,46	1	R803P
2	33,30	1	R804P

Recambio de hoja para podadera



R211P/R300P/R500P/R600P

	€		
Px/ Pxr N° 2, P1-20, P2-20	20,06	1	R211P
Px/ Pxr N° 2, P1-20, P2-20	18,67	80	R211P-BULK80
Px/ Pxr N° 1	19,70	1	R300P
Px/ Pxr N° 3	19,78	40	R500P
Px-M2-L & Pxr-M2-L	19,61	1	R600P

Recambio de contra-hoja para PX/PXR



R303P-R603P

	€		
Px-S1, Px-M1, Px-L1, Pxr-M1, Pxr-L1	21,03	1	R303P
Px-S2, Px-M2, Px-L2, Pxr-M2, Pxr-L2	21,25	1	R403P
Px-S3, Px-M3, Px-L3, Pxr-M3, Pxr-L3	19,28	1	R503P
Px-M2-L, Pxr-M2-L	18,77	1	R603P

Recambio de mangos para podaderas PX/PXR



ergo



R811P-RT825P

	€		
Px-S	26,00	1	R811P
Px-M	24,59	1	R812P
Px-L	24,60	1	R813P
Px-M2-L	25,66	1	R815P
PxR-S	49,92	1	RT821P
PxR-M	47,89	1	RT822P
PxR-L	55,10	6	RT823P
PxR-M2-L	65,33	1	RT824P
PXR-S2-L	49,94	6	RT825P

Recambio del perno central para podadera ERGO™



R900P

	g	€		
PX & PXR	20 g	8,00	1	R900P

Recambio del bloqueo del perno central



R901P

	g	€		
PX & PXR	10 g	7,17	30	R901P

Juego de recambio de 4 tornillos para PX/
PXR



R902P

Icono	g	€	Paquete	Modelo
PX & PXR	20 g	6,45	24	R902P

Recambio muelles

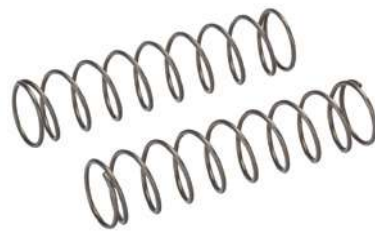

R905P-R907P

Icono	g	€	Paquete	Modelo
PX & PXR, P64	10 g	5,87	1	R905P
PX & PXR, P64	164 g	2,32	50	R905P-BULK50
PX & PXR	10 g	5,87	1	R906P
PX & PXR	220 g	2,46	50	R906P-BULK50
PX & PXR	10 g	6,10	1	R907P

Dureza: R905P (blanda) R906P (media) R907P (dura)

Podadera una mano con mango de
composite



P1

Icono	L	€	Paquete	Modelo
20 mm	200 mm	42,36	5	P1-20
30 mm	230 mm	47,66	5	P1-23

Repuestos disponibles

Recambio de 2 topos de goma para
podaderas PX/PXR



R903P/R1269P

Icono	g	€	Paquete	Modelo
PX & PXR, P1 & P2, P64	10 g	5,26	1	R903P
PX & PXR, P1 & P2, P64	486 g	1,37	50	R1269P-BULK50

Podadera de una mano, forjada



P3

Icono	€	Paquete	Modelo
20 mm	60,85	2	P3-20-F
25 mm	63,24	2	P3-23-F

Podadera de una mano



P108

Icono	L	€	Paquete	Modelo
20 mm	200 mm	31,82	2	P108-20-F
25 mm	230 mm	36,37	2	P108-23-F

Recambio del cierre para podaderas PX/
PXR



R904P

Icono	g	€	Paquete	Modelo
Px & Pxr	10 g	7,36	1	R904P

Podadera de una mano



P110

Icono	€	Paquete	Modelo
20 mm	30,68	2	P110-20-F
25 mm	34,78	2	P110-23-F

Podadera de una mano, forjada



P5

Icono	L	€	Paquete	Modelo
25 mm	230 mm	71,15	2	P5-23-F



Podadera de una mano



P138

Blade Size	Length (L)	Price (€)	Quantity	Product Code
20 mm	220 mm	29,87	6	P138-22-BULK6
20 mm	220 mm	42,97	6	P138-22-F

Podadera de una mano



P121

Blade Size	Length (L)	Price (€)	Quantity	Product Code
15 mm	180 mm	23,30	6	P121-18-F
20 mm	200 mm	24,43	6	P121-20-F
25 mm	230 mm	25,57	6	P121-23-F

Recambio del yunque de aluminio con remache



R221P/R222P

Product Code	Price (€)	Quantity	Product Code
P138-22	7,47	1	R221P
P138-22	5,67	50	R221P-BULK50

Tijeras para recolección de rosas



P64

Blade Size	Length (L)	Price (€)	Quantity	Product Code
12 mm	210 mm	39,68	12	P64-20-BULK12

Podadera de una mano



P126

Blade Size	Length (L)	Price (€)	Quantity	Product Code
15 mm	190 mm	17,50	6	P126-19-F
20 mm	220 mm	22,50	6	P126-22-F

Recambio de hoja para P1 y P2



R201P/R171P

Product Code	Price (€)	Quantity	Product Code
P1-22, P2-22	20,98	1	R201P
P1-22, P2-22	12,45	80	R201P-BULK80

Podadera para trabajos de mantenimiento jardín



PG-01-F/PG-03-L

Blade Size	Price (€)	Quantity	Product Code
12-20 mm	31,68	6	PG-01-F
12-20 mm	32,68	2	PG-03-L

PG-01-F: Diestros PG-03-L: Zurdos

Podadera de una mano



PG-12-F

Blade Size	Length (L)	Price (€)	Quantity	Product Code
20 mm	210 mm	15,06	10	PG-12-F
20 mm	210 mm	13,97	15	PG-12-BULK15

Recambios de hoja con pasador para podaderas una mano y de pértiga



R112PG-R124PG/R224P

Product Code	Price (€)	Quantity	Product Code
P3-20, P5-20	16,95	1	R112PG
P108-20, P110-20	17,14	1	R114PG
P3-23, P5-23	18,00	30	R122PG
P108-23, P110-23, P34-27A	18,29	30	R124PG
P138-22	20,41	1	R223P
P138-22	17,00	80	R223P-BULK80

Recambio de contra-hoja para podaderas una mano



R202P/R271P

	€		
P1-22, P2-22	21,55	1	R202P

Recambio de cierre



R341P/R474P

	€		
P3-20, P3-23	5,05	12	R341P
P5-20, P5-23, P108-20, P108-23, P110-20, P110-23	4,88	1	R474P

Recambio de muelle, tope de goma y tope metálico



R1068

	€		
P3-20, P3-23, P5-20, P5-23, P108-20, P108-23, P110-20, P110-23	6,30	1	R1068

Perno completo para podaderas de una mano



R239P/R141P/R142P/R157H

	€		
P34-27A, P3-20, P3-23, P5-20, P5-23, P108-20, P108-23, P110-20, P110-23	7,71	24	R142P
P121-23	15,61	1	R148V
P1-20, P1-22, P2-20, P2-22, P6-20, P7-20	8,50	1	R239P

Recambio de muelles para podaderas de una mano

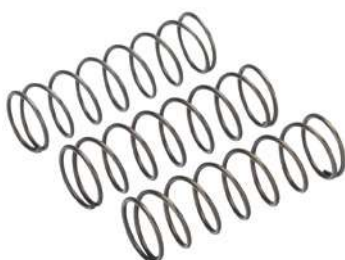

R438P/R463P

	€		
P121-20	6,67	1	R434P
P121-20	1,93	50	R434P-BULK50
P121-23	7,38	1	R463P
P138-22	6,31	1	R438P
P138-22	1,94	50	R438P-BULK50

Recambios para P5-20 y P-23



R1080P

	€		
P5-20, P5-23	6,22	1	R1080P

Recambios de contra-hoja y pasador



R113PG/R123PG

	€		
P108-20, P110-20	18,29	30	R113PG
P108-23, P110-23	18,11	30	R123PG

Recambio de muelle y tope para podaderas de una mano



R1069P

	€		
P1-20, P2-20, P6-20, P7-20	5,30	12	R1069P

Recambio de tornillos, tuerca y cierre para los mangos



R1601

	€		
P1-20, P1-22, P2-20, P6-20, P7-20	8,30	1	R1601



Sistema de cierre con tornillo y tuerca



R478P/R480P

	€		
P108	9,00	1	R478P
P5	7,28	1	R480P

HERRAMIENTAS PARA RECOGIDA DE FRUTA

Tijera de vendimia y recolección



P123

	€		
10 mm	11,45	30	P123-19-BULK30

Tijera de vendimia y recolección



P127

	€		
6 mm	11,26	30	P127-19-BULK30

Tijera de vendimia y recolección



P128

	€		
6 mm	14,68	6	P128-19
6 mm	11,56	30	P128-19-BULK30

Tijera de vendimia y recolección



P129

	€		
6 mm	12,55	30	P129-19-BULK30

Recambios de muelles y topes



R1071/R1075

	g	€	
P123, P127, P128, P129	20 g	10,64	14 R1071
P123, P127, P128, P129	130 g	1,07	50 R1075-BULK50

TIJERAS DE PODAR DE DOS MANOS

Podadora super ligera



P114-SL

	L	€	
30 mm	400 mm	76,27	2 P114-SL-40
30 mm	500 mm	77,85	2 P114-SL-50
30 mm	600 mm	84,78	2 P114-SL-60

Podadora de dos manos



P16

	L	€	
30 mm	400 mm	76,09	2 P16-40
30 mm	500 mm	91,90	2 P16-50-F
30 mm	600 mm	94,97	2 P16-60-F

Podadora de dos manos



P16-40W

	L	€	
30 mm	400 mm	75,91	2 P16-40W

Podadera super ligera



P116-SL

Blade Size	Length	Price (€)	Quantity	Model
35 mm	400 mm	87,96	2	P116-SL-40
35 mm	500 mm	92,11	2	P116-SL-50
35 mm	600 mm	94,98	2	P116-SL-60
35 mm	700 mm	97,90	2	P116-SL-70

Podadera de corte deslizante y multiplicador



P280-SL

Blade Size	Length	Price (€)	Quantity	Model
55 mm	600 mm	67,90	2	P280-SL-60
55 mm	800 mm	73,87	2	P280-SL-80

Podadera ligera de dos manos



PG-18

Blade Size	Length	Price (€)	Quantity	Model
40 mm	450 mm	39,77	2	PG-18-45-F
40 mm	610 mm	43,19	2	PG-18-60-F

Podadera super ligera



P160-SL

Blade Size	Length	Price (€)	Quantity	Model
45 mm	600 mm	102,45	2	P160-SL-60
45 mm	750 mm	108,63	1	P160-SL-75
45 mm	900 mm	116,25	1	P160-SL-90

Podadera tipo cizalla con sistema multiplicador



P173-SL

Blade Size	Length	Price (€)	Quantity	Model
45 mm	850 mm	106,04	1	P173-SL-85

Tijeras de podar de dos manos telescópica mango bi-componente 700-900 mm.



PG-19

Blade Size	Length	Price (€)	Quantity	Model
40 mm	700 - 900 mm	58,73	2	PG-19-F

Podadera de dos manos



P19

Blade Size	Length	Price (€)	Quantity	Model
50 mm	800 mm	167,73	1	P19-80-F

Tijera de podar de dos manos



P130-P140

Blade Size	Length	Price (€)	Quantity	Model
40 mm	450 mm	36,08	6	P130-F
40 mm	660 mm	45,77	6	P140-F

Recambio de hoja para podaderas de dos manos



R114V/R373A

Model	Price (€)	Quantity	Model
P160-SL	19,88	28	R160A-BULK28
P280-SL-80	24,46	25	R185V
P14	32,96	25	R114V
P14	22,84	28	R114V-BULK28
P280	23,17	1	R181P
P-SL2, P116-SL	33,05	1	R16V
P-SL2, P116-SL	22,92	14	R16V-BULK14
P-SL, P114-SL	32,87	8	R115V
P-SL, P114-SL	26,73	14	R115V-BULK14
P16	29,73	1	R116V
P16	25,55	36	R116V-BULK36
P19-80	51,35	1	R119V
P160	25,30	1	R160A
P173-SL-85	32,76	25	R373A



Recambio de contra-hoja para podaderas de dos manos



R214V/R26V/R260A/...

Icono	€	Paquete	Modelo
P14	27,93	1	R214V
P14	15,03	28	R214V-BULK28
P116-SL	27,06	8	R216SL
P-SL-40/45/60	28,58	1	R215V
P114-SL	25,80	1	R214SL
P160	24,93	16	R260A
P16*	27,80	40	R716VCB
P180-70	24,21	1	R680V
P19-80	31,72	1	R619V

Recambio de topes de goma para podaderas de dos manos y cortasetos



R430V-R516V

Icono	€	Paquete	Modelo
P-SL, P-SL2, P114, P116, P52-SL, P54-SL	7,65	22	R440V

Recambio de yunque con tornillos para podaderas de dos manos



R372H

Icono	€	Paquete	Modelo
P172-65/-85, P172-SL	19,66	1	R372H

Perno central/tuerca para podaderas de dos manos



R312V-R318V/R143PV/R144PV/R146

Icono	€	Paquete	Modelo
P280-SL	10,62	12	R335V
P16	7,04	1	R143PV
P16*	7,67	1	R143PVCB
P160	7,10	24	R144PV
P14, P174, P176-75	7,12	24	R146VS
P14, P174, P176-75	4,61	50	R146VS-BULK50
P114-SL, P116-SL	9,51	22	R166V
P172-65/-85	15,02	1	R312V
P-SL-40/-45/-60	12,67	1	R315V
P280-(SL)	6,67	22	R328V
P180-70, P19-80, P172	13,58	1	R318V

Juego completo recambios mango, tornillo y tuerca para podaderas de dos manos



R415V-R775V

Icono	€	Paquete	Modelo
P280-SL	10,16	1	R775V
P173-SL-85	18,50	1	R776V
P-SL, P-SL2, P114, P116	9,92	1	R415V
P19-80	10,11	1	R519V
P14, P16	9,38	1	R615V
P160	8,78	24	R660V
P172-SL	6,51	14	R772V
P280-SL-80	6,12	1	R773V

Tornillo hexagonal para ajustar a la hoja al yunque



R272H

Icono	€	Paquete	Modelo
P173-SL-85	16,71	30	R472H
P172-65/-85, P172-SL-85	9,98	1	R272H

SERRUCHOS CON PÉRTIGA Y PODADERAS DE ALTURA

Pértiga telescópica de aluminio



ATP-200

Icono	€	Paquete	Modelo
2000-3520 mm	96,59	1	ATP-200-350
2070-5040 mm	112,51	1	ATP-200-500

Pértigas telescópicas



AP-FP-

Icono	€	Paquete	Modelo
2000 - 5000 mm	79,55	1	AP-5M
2000 - 3500 mm	60,23	1	AP-3M
1800 - 3200 mm	98,95	1	FP-3M

Pértiga telescópica corta de aluminio



ATP-110-210

Icono	€	Paquete	Modelo
1100 - 2100 mm	75,91	1	ATP-110-210

Pértiga base de aluminio



ASP-1850G

	€		
1870 mm	51,21	1	ASP-1850G



Adaptador para podaderas de altura P34-37 y P34-27A-F



ASP-ATP

		€		
160 mm	100 g	27,71	6	ASP-ATP

Podadera de pértiga, triple efecto multiplicador



P34-37

	€		
40 mm	68,18	2	P34-37



Extensión de aluminio para pértiga



ASP-1850

	€		
1870 mm	42,17	1	ASP-1850



Adaptador para serruchos ASP-AS en pértigas tradicionales AP-3M, AP-5M & FP-3M



RAUNI

		€		
ATP-110-210	82 g	17,95	6	RAUNI

Podadera de pértiga, Doble efecto multiplicador



P34-27A

	€		
30 mm	36,37	2	P34-27A-F



Adaptador para hojas de serruchos ASP-AS



ASP-AS

	€		
135 mm	18,21	6	ASP-AS

Gancho para pértiga con adaptador válido para pértigas ASP y pértiga ATP-110-210



ASP-AS-HOOK

	€		
325 g	39,76	4	ASP-AS-HOOK



Podadera de altura con pértiga telescópica y cabeza de corte giratoria



ATP-230-410

		€		
32 mm	2370 - 4110 mm	107,96	2	ATP-230-410



Podadera con pértiga



AP-234

		€		
30 mm	2200 mm	92,79	2	AP-234-F

Hoja, tornillo y tuerca para podadera de pértiga ATP-230-410

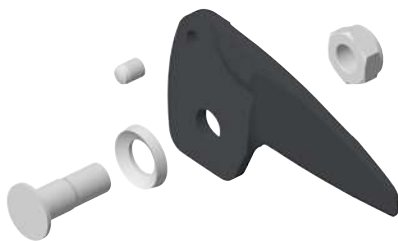

R230P

		€		
ATP-230-410	62 g	23,98	10	R230P

Tope de goma y mango interior para podadera de pértiga



RBCP230

		€		
ATP-230-410	66 g	10,58	12	RBCP230

Set de pértigas con podadera de altura P34-37 y adaptador



ASP3740-P

	€		
40 mm	239,67	1	ASP3740-P3437

ASP-1850G



ASP-1850



P34-37



ASP-ATP



4750-PSTB-1



Muelle para podadera de pértiga ATP-230-410



R4230

		€		
ATP-230-410	7 g	7,15	10	R4230

Leva y tornillo para ATP-200-350/500



RCAM

		€		
ATP-200-350 ; ATP-200-500 ; ATP-110-210	29 g	4,34	20	RCAM30
ATP-200-500 ; ATP-110-210	37 g	4,34	20	RCAM36

Recambio de hoja de corte para podadera de pértiga



R137E

	€		
P34-37	20,72	30	R137E

Tope de goma



RBCP

		€		
ATP-110-210	30 g	10,95	10	RBCP

Cuerda de 1 metro para ATP-230-410



RD1M

		€		
ATP-230-410	5 g	13,17	15	RD1M

Recambio de perno central y tuerca



R142P/R337E

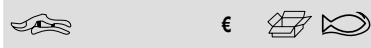

P34-37 10,38 1 R337E

Multiplicador para ATP-230-411



RPL230G

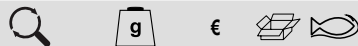

ATP-230-410 72 g 25,22 8 RPL230G

Serrucho curvo con dentado japonés, para pértigas ASP. Corte medio



ASP-AS-C_M



360 mm 6.2 64,74 5 ASP-AS-C36-JT-M

Cuerda de 7 metros para ATP-230-411



RD7M



ATP-230-410 19 g 24,58 20 RD7M

Recambio de muelle para podadera de pértiga



R427AE/R427E/R437E

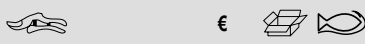

P134, P34-27A 9,33 18 R427AE
P34-37 10,38 18 R437E

Serrucho curvo con dentado japonés, para pértigas ASP. Corte grueso



ASP-AS-C_C



390 mm 5.4 71,09 5 ASP-AS-C39-JT-C
450 mm 5.4 73,63 2 ASP-AS-C45-JT-C

Recambio de contra-hoja para podaderas de una mano y de pértiga



R133PG

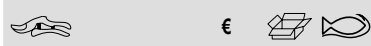

P34-27A 12,83 1 R133PG

Serrucho curvo con dentado japonés, para pértigas ASP. Corte fino



ASP-AS-C_F

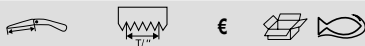

330 mm 7 62,08 5 ASP-AS-C33-JT-F

Serrucho de poda



339-/340-



360 mm 6 17,63 4 339-6T
360 mm 6 18,81 4 340-6T



Serrucho de poda



383-/384-

			€		
360 mm	6	19,98	4	383-6T	
360 mm	6	18,81	4	384-6T	
360 mm	5	18,81	4	384-5T	

Set de pértigas con serrucho de 390 mm



ASP3740-C39JTC

		€		
1950 mm	2838 g	246,36	1	ASP3740-C39JTC

ASP-1850G				
ASP-1850				
ASP-AS-C39-JT-C				
4750-PSTB-1				

Cortasetos



P51-SL

		€		
570 mm	25 cm	51,71	2	P51-SL

Serrucho de poda, para pértiga telescópica de Ø 25 mm



385-/386-

			€		
360 mm	6	19,98	4	385-6T	
360 mm	6	21,15	4	386-6T	

Set de pértigas con serrucho de 450 mm



ASP3740-C45JTC

		€		
1950 mm	2863 g	247,18	1	ASP3740-C45JTC

ASP-1850G				
ASP-1850				
ASP-AS-C45-JT-C				
4750-PSTB-1				

Cortasetos mangos largos



P51H-SL

		€		
730 mm	25 cm	54,55	2	P51H-SL

Set de pértigas con serrucho de 360 mm



ASP3740-C36JTM

		€		
1950 mm	2819 g	202,80	1	ASP3740-C36JTM

ASP-1850G				
ASP-1850				
ASP-AS-C36-JT-M				
4750-PSTB-1				

CORTASETOS

Cortasetos profesional, mangos largos



P51

		€		
570 mm	25 cm	51,71	2	P51-F

Cortasetos con mango de madera



P57-25

		€		
540 mm	23 cm	39,77	4	P57-25-F

Cortasetos ligero, corto



P54-SL

		€		
550 mm	22.5 cm	106,82	2	P54-SL-25

Cortasetos ligero



PG-56

		€		
540 mm	23 cm	40,91	2	PG-56-F

Recambios de topes de goma para corta setos



R440V-R516V

	€		
P14, P16, P180-70, P19-80, P160-60, P51	5,29	22	R515VS
P160, P160-SL, P280-SL	4,45	22	R516V
P53-SL, P54H-SL, P52-SL-20	5,94	22	R444V

Cortasetos ligero, mango largo



P54H-SL

		€		
650 mm	22.5 cm	106,81	2	P54H-SL-25

Cortasetos telescópico



PG-57-F

		€		
800-1050 mm	20 cm	43,19	2	PG-57-F

Perno central/tuerca para cortasetos



R146VC/R147V

	€		
P51, P51H, P52, P53, P54, P52-SL-20	8,22	22	R146VC
P55, P57	7,11	24	R147V

Cortasetos ligero de precisión para arte topiario



P52-SL-20

		€		
590 mm	18 cm	88,60	2	P52-SL-20

Cortasetos



P59

		€		
580 mm	21 cm	33,17	6	P59-25-F

TIJERAS CORTACÉSPEDES

Tijera cortacésped regulable en tres posiciones



GS-76

		€		
355 mm	435 g	20,98	8	GS-76



Tijera cortacésped regulable de 9 posiciones (180°)



GS-180

		€		
375 mm	317 g	28,62	6	GS-180-F

Tijera cortacésped



P74

		€		
1100 mm	2000 g	61,63	1	P74

Tijera cortacésped



P75

		€		
1000 mm	1900 g	60,53	1	P75

NAVAJAS DE PODA

Navaja para injertar



P11

		€		
180 mm	70 g	40,53	6	P11

Navaja para injertar



P20

		€		
190 mm	100 g	48,11	6	P20

Navaja multi-uso



K-AP-1

	€		
90 g	31,44	10	K-AP-1

Navaja multi-uso



K-GP-1

	€		
90 g	34,46	10	K-GP-1

TIJERAS FLORALES

Tijera tamaño pequeño



FS-5

€		
16,31	10	FS-5

Tijera tamaño medio



FS-8

€		
22,20	10	FS-8

Tijera tamaño grande



FS-7.5

€ 27,39 10 FS-7.5

ARCOS TRONZADORES

Arco tronizador para madera verde y seca



ergo



10

			€		
530 mm	21 in	5	15,49	5	10-21-51
607 mm	24 in	5	16,64	5	10-24-23
607 mm	24 in	5	16,63	5	10-24-51
759 mm	30 in	5	18,81	5	10-30-23
759 mm	30 in	5	20,24	5	10-30-51

Arco tronizador



ergo



332

			€		
530 mm	21 in	5	18,34	5	332-21-51

Arco tronizador profesional



SE -15-16

			€		
530 mm	21 in	5	8,53	5	SE-16-21
530 mm	21 in	5	7,37	5	SE-16-21-23
607 mm	24 in	5	8,38	5	SE-15-24
759 mm	30 in	5	8,90	5	SE-15-30
759 mm	30 in	5	8,98	5	SE-15-30-23
810 mm	32 in	5	9,82	5	SE-15-32
912 mm	36 in	5	10,45	5	SE-15-36
912 mm	36 in	5	10,40	5	SE-15-36-23

Arco tronizador



331-21

			€		
530 mm	21 in	5	15,49	5	331-21-51-KP

Arco tronizador manejable de 15" madera verde



331-15

			€		
378 mm	15 in	5	14,48	5	331-15-23

Arco tronizador con hoja posicionable



3-24-51

			€		
607 mm	24 in	5	18,45	5	3-24-51

Arco tronizador con hoja posicionable



2-21-51

			€		
530 mm	21 in	5	16,35	5	2-21-51

Arco tronizador con hoja posicionable



333

			€		
350 mm	14 in	5	29,45	5	333



Arco tronizador para tubos de ventilación



14-24

Icon	Icon	€	Icon	Icon
607 mm	24 in	21,28	5	14-24-3810

Arco de sierra multiuso - madera y metal



9-12

Icon	Icon	€	Icon	Icon
320 mm	12 in	18,52	5	9-12-51/3806-KP

Hoja de arco tronizador - madera seca



51

L	L	€	Icon	Icon
320 mm	12-1/2 in	3,58	10	51-12
530 mm	20.75 in	4,83	10	51-21
607 mm	24 in	5,16	10	51-24
759 mm	30 in	5,78	10	51-30
810 mm	28.57 in	6,00	10	51-32
912 mm	36 in	6,23	10	51-36

Hoja de arco tronizador - madera verde



23

L	L	€	Icon	Icon
378 mm	13.33 in	2,73	10	23-15
530 mm	20.75 in	4,83	10	23-21
607 mm	24 in	5,16	10	23-24
759 mm	30 in	5,78	10	23-30
810 mm	28.57 in	6,00	10	23-32
912 mm	36 in	6,38	10	23-36

Hoja para arco tronizador: madera verde para arco 333



333-5

L	L	€	Icon	Icon
350 mm	13-3/4 in	7,29	10	333-5

SERRUCHOS DE PODA

Serrucho de poda



349

Icon	Icon	€	Icon	Icon
300 mm	7	18,67	4	349

Serrucho de poda plegable



PG-72

Icon	Icon	€	Icon	Icon
190 mm	7	17,80	4	PG-72

Serrucho plegable, dentado XT, recubrimiento especial



396-LAP

Icon	g	€	Icon	Icon
190 mm	200 g	38,44	10	396-LAP
190 mm	44 g	15,88	100	396-BLADE
190 mm	44 g	14,52	1	396-BLADE-1P

Serrucho de poda plegable, dentado JS



396-JS

Icon	Icon	€	Icon	Icon
190 mm	5	23,50	4	396-JS

Serrucho de poda plegable, dentado JT



396-JT



		€		
190 mm	7	23,50	4	396-JT

Serrucho de poda con funda, sin velcro



51-JS



		€		
240 mm	5	51,03	4	5124-JS-H
280 mm	5	57,25	4	5128-JS-H

Hojas de recambio para serrucho de poda 51-JS



5724-JS/5728-JS

		€		
240 mm	5	34,24	1	5724-JS
280 mm	5	39,31	1	5728-JS

Serrucho de poda plegable, dentado XT



396-HP



		€		
190 mm	7	19,98	4	396-HP

Serrucho de poda, dentado JT



41-JT



		€		
240 mm	7	23,50	4	4124-JT-H
280 mm	7	28,21	4	4128-JT-H

Hojas de recambio para serrucho de poda 41-JT



4724-JT/4728-JT

		€		
240 mm	7	17,63	1	4724-JT
280 mm	7	18,21	1	4728-JT

Serrucho de poda con mango de madera



4211-4212-



		€		
280 mm	6	17,63	4	4211-11-6T
360 mm	6	19,98	4	4211-14-6T
280 mm	6	17,63	4	4212-11-6T
360 mm	6	19,98	4	4212-14-6T

Juego de serrucho plegable 396-LAP y cuchillo - machete 2444-LAP



LAP-KNIFE



	g	€		
329 g		41,50	10	LAP-KNIFE

396-LAP
2444-LAP

Hojas de recambio para serrucho 396-JS



396-JS-BLADE

		€		
190 mm	5	21,15	300	396-JS-BLADE



Hojas de recambio para serrucho 396-JT



396-JT-BLADE

		€		
190 mm	7	21,15	300	396-JT-BLADE

Hoja de recambio para serrucho 396-HP



396-HP-BLADE

		€		
190 mm	7	12,92	300	396-HP-BLADE

Hojas de recambio, serrucho/poda 4211, 4212, 339 y 340



4400-/4420-

		€		
280 mm	6	11,45	10	4400-11
360 mm	6	12,92	10	4400-14
280 mm	6	11,45	10	4420-11
360 mm	6	12,92	10	4420-14
280 mm	6	9,99	10	4400-11-BULK
360 mm	6	11,16	10	4400-14-BULK
280 mm	6	9,99	10	4420-11-BULK
360 mm	6	11,16	10	4420-14-BULK

REPUESTOS Y ACCESORIOS

Hoja curva de repuesto serrucho para pértiga, corte fino



AS-F-BLADE

		€		
330 mm	7	32,91	15	AS-C33-JT-F

Hoja curva de repuesto serrucho para pértiga, corte medio



AS-M-BLADE

		€		
360 mm	6.2	35,26	15	AS-C36-JT-M

Hoja curva de repuesto serrucho para pértiga, corte grueso



AS-C-C-BLADE

		€		
390 mm	5.4	35,26	15	AS-C39-JT-C
450 mm	5.4	41,13	15	AS-C45-JT-C

ACCESORIOS Y MANTENIMIENTO

Piedra sintética para afilado, 2 granos 180/400



LS-COMBINESS

	€		
100 mm	12,94	1	LS-COMBINESS

Piedra sintética para afilado, grano 320



LS-CORINDON

	€		
100 mm	15,43	1	LS-PIERRE CORINDON

Afilador profesional de carburo



SHARP-X

	€		
100 mm	23,25	10	SHARP-X
100 mm	697,29	1	SHARP-X-DISP

Piedra sintética para afilado, grano 180



LS-PIERRE-FAUX



230 mm

€

16,39



1

LS-PIERRE-FAUX

Piedra sintética, tipo "Carbor", para afilado, grano 220



LS-6160-23



230 mm

€

8,94



1

LS-6160-23

Lubricante 50 ml



LUB-2015



60 g

€

19,96



6

LUB-2015



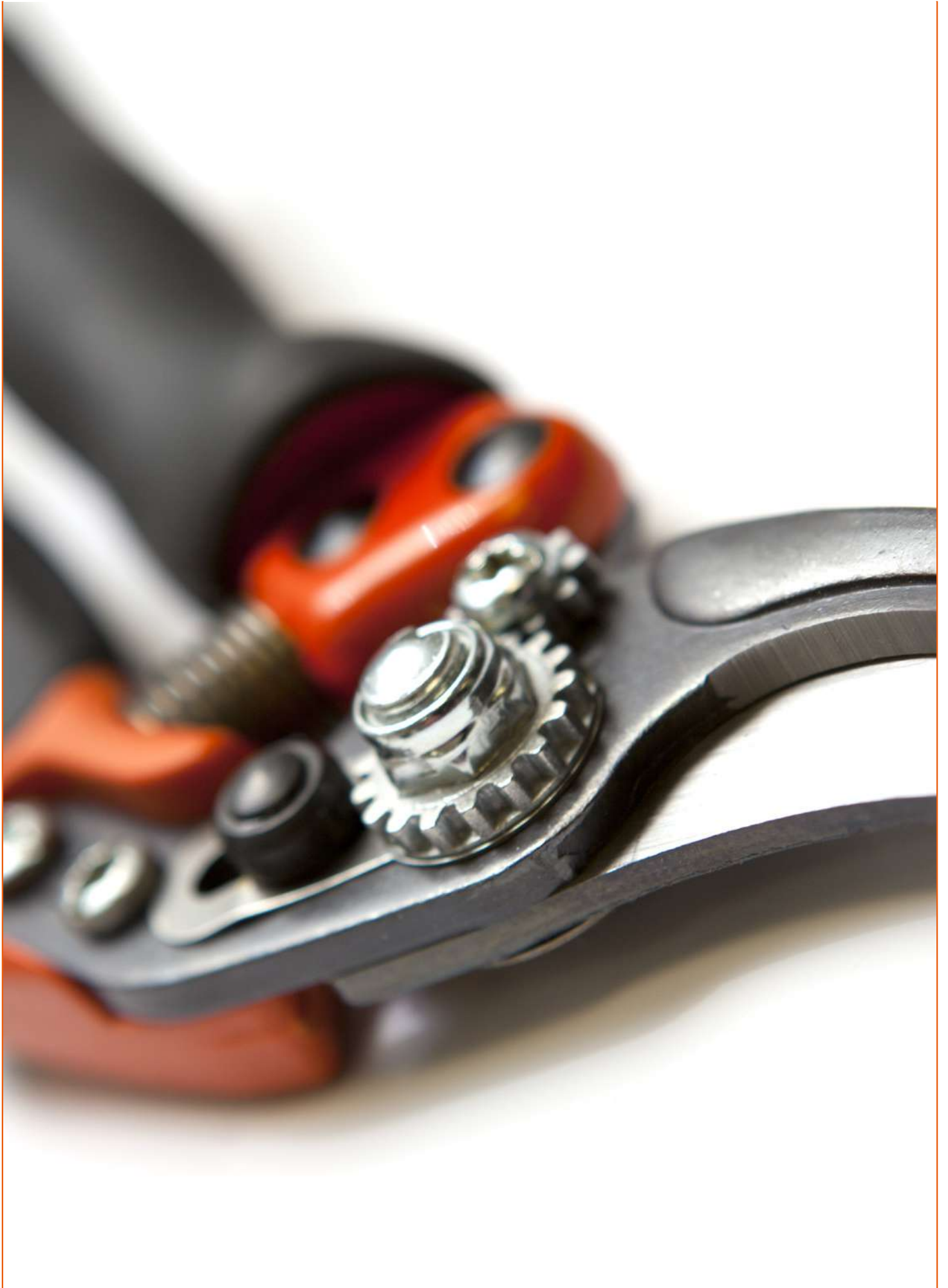

BAHCO



Herramientas neumáticas de exterior



TIJERAS DE PODA NEUMÁTICAS

Podadera neumática



9210

		€		
30 mm		249,92	1	9210

Hoja para podadera neumática



9210-1

		€		
9210	82 g	54,23	1	9210-1

Cabeza cortante para podadera neumática



9210-10

		€		
9210	212 g	101,79	1	9210-10

Anillos para las juntas Tijera Neumática 9210



9210-20

		€		
9210	28 g	13,99	1	9210-20

Casquillos de latón



9210-1720100

		€		
9210	55.3 g	11,14	1	9210-1720100

Sello para pistón



9210-1230235

		€		
9210	6.7 g	7,85	1	9210-1230235

Pistón



9210-1690148

		€		
9210	22 g	19,28	1	9210-1690148

Amortiguadores



9210-1730107

		€		
9210	176 g	13,41	10	9210-1730107

Muelles de retorno



9210-1640142

		€		
9210	26.6 g	8,45	1	9210-1640142

Varilla de acoplamiento



9210-1700118

		€		
9210	41 g	40,84	1	9210-1700118

Tornillos autorroscantes o de chapa



9210-1060238

		€		
9210	10 g	0,47	20	9210-1060238

Tornillo TCCE



9210-1060177

		€		
9210	7 g	0,90	1	9210-1060177

Remache



9210-1770106

		€		
9210	1000 g	5,62	10	9210-1770106

Cubierta frontal



9210-1830137

		€		
9210	9.5 g	8,95	1	9210-1830137

Protector de mano



9210-1320281

		€		
9210	35 g	9,03	10	9210-1320281

Junta de protección del polvo



9210-1230219

		€		
9210	8.6 g	6,78	20	9210-1230219

Cuerpo de podadera



9210-1710266

		€		
9210	193 g	66,75	1	9210-1710266





BAHCO



Lindström

CORTANTES DE PRECISIÓN

ALICATES CORTE DIAGONAL

Alicates de corte diagonal de precisión ERGO™ con cabeza ovalada



ergo



RX 8130-RX 8162

		€			
0.00-0.04 / 0.2-1.0	Micro-Bevel®	77,30	10	RX 8130	
0.00-0.04 / 0.1-1.0	Flush	82,80	10	RX 8131	
0.00-0.03 / 0.1-0.8	Ultra-Flush®	95,60	10	RX 8132	
0.00-0.05 / 0.2-1.25	Micro-Bevel®	68,20	10	RX 8140	
0.00-0.05 / 0.1-1.25	Flush	74,78	10	RX 8141	
0.00-0.04 / 0.1-1.0	Ultra-Flush®	79,29	10	RX 8142	
0.01-0.06 / 0.3-1.6	Micro-Bevel®	80,23	10	RX 8150	
0.00-0.06 / 0.2-1.6	Flush	87,12	10	RX 8151	
0.00-0.05 / 0.2-1.25	Ultra-Flush®	86,74	10	RX 8152	
0.02-0.08 / 0.4-2.0	Micro-Bevel®	76,25	10	RX 8160	
0.01-0.08 / 0.3-2.0	Flush	92,48	10	RX 8161	
0.01-0.06 / 0.3-1.6	Ultra-Flush®	101,46	10	RX 8162	

Alicates de corte diagonal de precisión con cabeza ovalada y mango de seguridad ESD



8130-8162

		€			
0.01-0.04 / 0.2-1.0	Micro-Bevel®	49,23	10	8130	
0.00-0.04 / 0.1-1.0	Flush	26,21	10	8131	
0.00-0.03 / 0.1-0.8	Ultra-Flush®	65,11	10	8132	
0.01-0.05 / 0.2-1.25	Micro-Bevel®	51,44	10	8140	
0.00-0.05 / 0.1-1.25	Flush	50,35	10	8141	
0.00-0.04 / 0.1-1.0	Ultra-Flush®	57,57	10	8142	
0.01-0.06 / 0.3-1.6	Micro-Bevel®	64,12	10	8150	
0.01-0.06 / 0.2-1.6	Flush	54,72	10	8151	
0.00-0.05 / 0.1-1.25	Ultra-Flush®	70,17	10	8152	
0.02-0.08 / 0.4-2.0	Micro-Bevel®	61,61	10	8160	
0.01-0.08 / 0.3-2.0	Flush	65,15	10	8161	
0.01-0.08 / 0.3-1.6	Ultra-Flush®	75,68	10	8162	
0.00-0.04 / 0.1-1.0	Flush	71,50	10	8131 CO	
0.01-0.05 / 0.2-1.25	Micro-Bevel®	72,45	10	8140 CO	
0.00-0.05 / 0.1-1.25	Flush	52,69	10	8141 CO	
0.00-0.04 / 0.1-1.0	Ultra-Flush®	77,68	10	8142 CO	
0.01-0.06 / 0.3-1.6	Micro-Bevel®	74,53	10	8150 CO	
0.01-0.06 / 0.2-1.6	Flush	52,31	10	8151 CO	
0.02-0.08 / 0.4-2.0	Micro-Bevel®	77,30	10	8160 CO	
0.01-0.08 / 0.3-2.0	Flush	83,74	10	8161 CO	

Cortantes diagonales largos de precisión con cabeza ovalada y mango de seguridad ESD



HS 8130-HS 8162

		€			
0.2-1.25 mm	Micro-Bevel®	73,48	1	HS 8130	
0.1-1.25 mm	Flush	76,33	1	HS 8131	
0.1-0.8 mm	Ultra-Flush®	84,92	1	HS 8132	
0.2-1.25 mm	Micro-Bevel®	69,59	10	HS 8140	
0.1-1.25 mm	Flush	72,51	10	HS 8141	
0.1-1.0 mm	Ultra-Flush®	80,15	10	HS 8142	
0.3-1.6 mm	Micro-Bevel®	73,94	1	HS 8150	
0.2-1.6 mm	Flush	72,10	10	HS8151	
0.1-1.25 mm	Ultra-Flush®	83,46	10	HS8152	
0.4-2.0 mm	Micro-Bevel®	76,33	10	HS 8160	
0.3-2.0 mm	Flush	84,44	10	HS 8161	
0.3-2.0 mm	Ultra-Flush®	95,89	10	HS 8162	

Cortantes diagonales de precisión ERGO™ con cabeza cónica



ergo



RX 8133-RX 8165

		€			
0.008-0.04 / 0.2-1.0	Micro-Bevel®	66,95	10	RX8133	
0.004-0.03 / 0.1-0.8	Flush	66,95	10	RX8134	
0.004-0.02 / 0.1-0.5	Ultra-Flush®	66,95	10	RX8135	
0.01-0.05 / 0.2-1.25	Micro-Bevel®	82,98	10	RX 8143	
0.00-0.05 / 0.1-1.25	Flush	81,27	10	RX 8144	
0.00-0.04 / 0.1-1.0	Ultra-Flush®	81,23	10	RX 8145	
0.01-0.06 / 0.3-1.6	Micro-Bevel®	33,55	10	RX 8153	
0.01-0.06 / 0.2-1.6	Flush	33,55	10	RX 8154	
0.01-0.05 / 0.2-1.25	Ultra-Flush®	131,14	10	RX8155	
0.02-0.08 / 0.4-2.0	Micro-Bevel®	57,59	10	RX8163	
0.01-0.08 / 0.3-2.0	Flush	113,38	10	RX 8164	
0.01-0.06 / 0.3-1.6	Ultra-Flush®	116,12	10	RX 8165	

Cortantes diagonales de precisión con cabeza cónica



8133-8165

		€			
0.008-0.04 / 0.2-1.0	Micro-Bevel®	49,81	10	8133	
0.004-0.03 / 0.1-0.8	Flush	49,81	10	8134	
0.004-0.02 / 0.1-0.5	Ultra-Flush®	49,81	10	8135	
0.01-0.05 / 0.2-1.25	Micro-Bevel®	52,17	10	8143	
0.01-0.05 / 0.2-1.25	Flush	49,23	10	8144	
0.00-0.04 / 0.1-1.0	Ultra-Flush®	71,75	10	8145	
0.01-0.06 / 0.3-1.6	Micro-Bevel®	27,76	10	8153	
0.01-0.06 / 0.2-1.6	Flush	68,58	10	8154	
0.01-0.05 / 0.2-1.25	Ultra-Flush®	83,57	10	8155	
0.02-0.08 / 0.4-2.0	Micro-Bevel®	53,34	10	8163	
0.01-0.08 / 0.3-2.0	Flush	85,62	10	8164	
0.01-0.06 / 0.3-1.6	Ultra-Flush®	100,61	10	8165	
0.01-0.05 / 0.2-1.25	Flush	75,58	10	8144 CO	
0.01-0.06 / 0.2-1.6	Flush	73,96	10	8154 CO	
0.02-0.08 / 0.4-2.0	Micro-Bevel®	70,77	10	8163 CO	
0.01-0.06 / 0.3-1.6	Ultra-Flush®	115,10	10	8165 CO	

Alicates de corte diagonal con cabeza cónica y mango de seguridad ESD



7190-7191

		€			
0.00-0.04 / 0.2-1.0	Micro-Bevel®	61,47	10	7190	
0.00-0.04 / 0.1-1.0	Flush	59,47	10	7191	
0.00-0.04 / 0.2-1.0	Micro-Bevel®	67,82	10	7190 CO	
0.00-0.04 / 0.1-1.0	Flush	72,90	10	7191 CO	

Cortantes diagonales de precisión largos con cabeza cónica y mango de seguridad ESD



HS 8133-HS 8165

		€		
0.2-1.0 mm	Micro-Bevel®	63,48	1	HS8133
0.1-0.8 mm	Flush	63,48	1	HS8134
0.1-0.5 mm	Ultra-Flush®	63,48	1	HS8135
0.2-1.25 mm	Micro-Bevel®	75,87	10	HS 8143
0.2-1.25 mm	Flush	77,78	10	HS 8144
0.1-1.0 mm	Ultra-Flush®	81,11	10	HS 8145
0.3-1.6 mm	Micro-Bevel®	89,41	10	HS8153
0.2-1.6 mm	Flush	77,25	10	HS8154
0.2-1.25 mm	Ultra-Flush®	77,25	1	HS8155
0.3-2.0 mm	Micro-Bevel®	81,11	10	HS 8163
0.3-2.0 mm	Flush	54,08	10	HS 8164
0.3-1.6 mm	Ultra-Flush®	101,34	10	HS8165

Cortantes diagonales largos con cabeza cónica y mango de seguridad ESD



HS 7190-HS 7191

		€		
0.2-1.0 mm	Micro-Bevel®	60,11	1	HS7190
0.1-1.0 mm	Flush	60,11	1	HS7191

Cortantes diagonales de precisión ERGO™ con cabeza cónica y rebaje



ergo



RX 8136-RX 8168

		€		
0.004-0.03 / 0.1-0.8	Micro-Bevel®	66,95	10	RX8136
0.004-0.03 / 0.1-0.8	Flush	77,50	10	RX 8137
0.004-0.02 / 0.1-0.5	Ultra-Flush®	77,50	10	RX8138
0.01-0.04 / 0.2-1.0	Micro-Bevel®	68,31	10	RX 8146
0.00-0.04 / 0.1-1.0	Flush	83,57	10	RX 8147

		€		
0.00-0.03 / 0.1-0.8	Ultra-Flush®	93,25	10	RX 8148
0.01-0.05 / 0.3-1.25	Micro-Bevel®	61,11	10	RX 8156
0.01-0.05 / 0.2-1.25	Flush	74,80	10	RX 8157
0.01-0.04 / 0.2-1.0	Ultra-Flush®	169,45	10	RX 8158
0.02-0.06 / 0.4-1.5	Micro-Bevel®	57,59	10	RX8166
0.01-0.06 / 0.3-1.5	Flush	128,14	10	RX 8167
0.01-0.05 / 0.3-1.25	Ultra-Flush®	209,74	10	RX 8168

Cortantes diagonales de precisión con cabeza cónica y rebaje y mango de seguridad de ESD



8136-8168

		€		
0.004-0.03 / 0.1-0.8	Micro-Bevel®	49,81	10	8136
0.004-0.03 / 0.1-0.8	Flush	49,81	10	8137
0.004-0.02 / 0.1-0.5	Ultra-Flush®	49,81	10	8138
0.01-0.04 / 0.2-1.0	Micro-Bevel®	47,27	10	8146
0.01-0.04 / 0.1-1.0	Flush	66,11	10	8147
0.00-0.03 / 0.1-0.8	Ultra-Flush®	71,10	10	8148
0.01-0.05 / 0.3-1.25	Micro-Bevel®	70,35	10	8156
0.01-0.05 / 0.2-1.25	Flush	72,61	10	8157
0.01-0.04 / 0.2-1.0	Ultra-Flush®	80,45	10	8158
0.02-0.06 / 0.4-1.5	Micro-Bevel®	149,97	10	8166L
0.01-0.06 / 0.3-1.5	Flush	173,60	10	8167L
0.01-0.05 / 0.3-1.25	Ultra-Flush®	173,60	10	8168L
0.00-0.03 / 0.1-0.8	Ultra-Flush®	86,32	10	8148 CO

Cortantes diagonales largos de precisión con cabeza cónica y rebaje y mango de seguridad ESD



HS 8136-HS 8168

		€		
0.1-0.8 mm	Micro-Bevel®	63,48	1	HS8136
0.1-0.8 mm	Flush	63,48	1	HS8137
0.1-0.5 mm	Ultra-Flush®	63,48	1	HS8138
0.2-1.0 mm	Micro-Bevel®	77,50	10	HS8146
0.1-1.0 mm	Flush	77,50	10	HS8147

		€		
0.1-0.8 mm	Ultra-Flush®	84,44	10	HS 8148
0.3-1.25 mm	Micro-Bevel®	82,40	1	HS8156
0.2-1.25 mm	Flush	82,40	1	HS8157
0.2-1.0 mm	Ultra-Flush®	82,40	1	HS8158
0.4-1.5 mm	Micro-Bevel®	92,70	1	HS8166
0.3-1.5 mm	Flush	92,70	1	HS8167
0.3-1.25 mm	Ultra-Flush®	92,70	1	HS8168

ALICATES CORTE DIAGONAL, CABEZA ESPECIAL

Alicates de corte diagonal de precisión ERGO™ con cabeza cónica y con punta rebajada



ergo



RX8137MX-RX8138MX

		€		
0.1-0.8 mm	Flush	77,50	10	RX8137MX
0.1-0.8 mm	Ultra-Flush®	59,63	10	RX8138MX

ALICATES DE CORTE OBLICUO

Alicates de precisión de corte frontal oblicuo en ángulo 0,35 mm-1,25 mm



7290-7291

		€		
0.01-0.03 / 0.35-0.8	Micro-Bevel®	68,21	10	7290
0.01-0.03 / 0.35-0.8	Flush	71,83	10	7291

Cortantes frontales oblicuos de precisión
largos ángulo 11° 0,35 mm-1,25 mm



HS 7290-HS 7291

		€		
0.01-0.03 / 0.35-0.8	Micro-Bevel®	60,11	1	HS7290
0.01-0.03 / 0.35-0.8	Flush	69,59	1	HS7291

Alicates de corte frontal con cabeza muy
pequeña



7292

		€		
0.01-0.03 / 0.35	Flush	45,06	10	7292

Cortantes frontales oblicuos de precisión
largos con cabeza corta



HS 7292

		€		
0.01-0.03 / 0.35-0.8	Flush	73,58	10	HS7292

Alicates de corte oblicuo y angulados,
0,35-1 mm



7293

		€		
0.01-0.03 / 0.35-0.8	Flush	81,83	10	7293

Cortantes frontales oblicuos de precisión
largos ángulo 11° 0,35 mm-1 mm



HS 7293

		€		
0.01-0.04 / 0.35-1.0	Flush	60,11	1	HS7293

ÁNGULO

Alicates de corte oblicuo de 20° cortos
ERGO™, 0,2-1,2 mm



RX 8211

		€		
0.01-0.05 / 0.2-1.2	Flush	136,03	10	RX 8211

Alicates de corte oblicuo de 20° cortos,
0,2-1,2 mm



8211

		€		
0.01-0.05 / 0.2-1.2	Flush	80,57	10	8211

Cortantes con cabeza corta oblicua de
precisión largos 20° 0.2 mm-1.2 mm



HS 8211

		€		
0.01-0.05 / 0.2-1.2	Flush	137,11	10	HS8211

Alicates de corte oblicuo de 45° largos
ERGO™, 0,2-1 mm



RX 8247

		€		
0.01-0.04 / 0.2-1.0	Flush	84,26	10	RX 8247

Alicates de corte oblicuo de cabeza larga
de 45° de 0,2 mm-1 mm



8247

		€		
0.01-0.04 / 0.2-1.0	Flush	84,26	10	8247
0.01-0.04 / 0.2-1.0	Flush	124,81	10	8247 CO

Cortantes oblicuos con cabeza cónica de precisión 45° 0,2 mm-1 mm



HS 8247

		€		
0.01-0.04 / 0.2-1.0	Flush	123,56	1	HS 8247

Alicates de corte oblicuo de 45°, de cabeza larga y en relieve ERGO™, 0,2 mm-0,8 mm



ergo



RX 8248

		€		
0.01-0.03 / 0.2-0.8	Flush	149,17	10	RX 8248

Alicates de corte oblicuo de 45°, 0,2-1 mm



7285

		€		
0.2-1.0 mm	Flush	82,28	10	7285

Cortantes oblicuos con cabeza cónica y rebaje de precisión 45° 0.2 mm-0.8 mm



HS 8248

		€		
0.01-0.03 / 0.2-0.8	Flush	128,81	10	HS 8248

Alicates de corte oblicuo y ángulo inverso, 0,2-0,8 mm



7280

		€		
0.01-0.03 / 0.2-0.8	Flush	74,93	10	7280

Cortantes oblicuos de precisión largos 45° 0,2 mm-1 mm



HS 7285

		€		
0.01-0.04 / 0.2-1.0	Flush	60,11	1	HS7285

Alicates de corte oblicuo de cabeza larga y en relieve de 45° de 0,2 mm-0,8 mm



8248

		€		
0.01-0.03 / 0.2-0.8	Flush	97,85	10	8248
0.00-0.03 / 0.2-0.8	Flush	33,12	10	8249
0.01-0.03 / 0.2-0.8	Flush	133,10	10	8248 CO

Cortantes oblicuos inversos de precisión largos 0.2 mm-0.8 mm



HS 7280

		€		
0.01-0.03 / 0.2-0.8	Flush	60,11	1	HS7280

CORTANTE PARA PLÁSTICO

Alicates de plástico de corte diagonal ERGO™



ergo



P6160

		€		
1.5 mm	Flush	75,00	10	P6160

CORTE CON PUNTA

Alicates de corte diagonal con punta de precisión ERGO™



ergo



RX 8149

		€		
0.01-0.02 / 0.1-0.6	Flush	171,21	10	RX 8149

ALICATES DE CORTE OBLICUO, CABEZA ESPECIAL

Alicates de corte con cabeza larga con cabeza cónica y rebajada de 45° con cabeza especial de 0,2mm-0,8mm



8248Q

		€		
0.00-0.03 / 0.2-0.8	Ultra-Flush®	86,40	10	8248Q

Cortantes de precisión con micro puntas ERGO™, 141 mm



ergo



RX 8234

		€		
0.002-0.018 / 0.05-0.4	Flush	185,76	10	RX8234A

Alicates de corte diagonal con punta de precisión y mango protegido contra ESD



8149

		€		
0.00-0.02 / 0.1-0.6	Flush	132,53	10	8149

Alicates de corte frontal oblicuo de precisión con cabeza especial muy pequeña



7292G

		€		
0.01-0.03 / 0.35	Flush	125,54	10	7292G

Alicates de precisión con micropunta ERGO™, 144 mm



ergo



RX 8237

		€		
0.004-0.02 / 0.1-0.5	Flush	185,75	10	RX8237A

Cortantes de punta diagonal de precisión largos con mango de seguridad ESD



HS 8149

		€		
0.01-0.02 / 0.1-0.6	Flush	66,95	1	HS8149

CORTANTES PUNTA MICRO

Alicates de precisión con micropunta ERGO™, 149 mm



ergo



RX 8233

		€		
0.004-0.024 / 0.1-0.6	Flush	198,15	10	RX8233A

CIZALLAS MULTIUSOS

Alicates de corte multiusos con mangos antideslizantes



HS6000

		€		
Kevlar	Flush	75,87	10	HS6000
Kevlar	Flush	57,30	10	HS6001

ACCESORIOS Y REPUESTOS

Recogevirutas para alicates de corte diagonal de las series 8130 y 8140



813/814/816

	€		
8130-8132, Rx 8130-8132	6,00	1	813
8140-8148, Rx 8140-8148	4,52	1	814
8130-8132, 8140-8148	9,70	1	816

Muelles de retorno para la serie RX



RX 01

g	€		
5g	6,29	1	RX 01

Muelles de retorno para las series 80, Supreme y HS



8130-50/8160

g	€		
1g	3,52	1	8130-50/SUPR SPRING
1g	3,96	1	8160/SPRING

CORTANTES DE PRECISIÓN PARA MATERIALES DUROS

CORTANTE DE CARBURO

Alicates de corte diagonal de carburo de precisión con cabeza cónica para materiales duros



7154 TC

	€		
0.1-0.9 mm	226,53	10	7154TC

ALICATES CORTE DIAGONAL RENDIMIENTO ESPECIFICO

Alicates corte diagonal de precisión ERGO™ con cabeza ovalada



ergo



RX 8140PS-RX 8161PS

	€		
0.01-0.04 / 0.1-1.0 Micro-Bevel®	116,21	10	RX8140PS
0.01-0.04 / 0.1-1.0 Flush	39,10	10	RX8141PS
0.01-0.04 / 0.1-1.0 Micro-Bevel®	73,90	10	RX 8142PS
0.01-0.04 / 0.1-1.0 Micro-Bevel®	92,13	10	RX8150PS
0.01-0.06 / 0.3-1.6 Flush	52,26	10	RX 8161PS

ALICATES CORTE DIAGONAL EXTRA REFORZADO

Cortantes diagonales de precisión ERGO™ con cabeza ovalada y endurecido extra



ergo



RX 8140M2-8160M2

	€		
0.01-0.05 / 0.4-2.0 Micro-Bevel®	116,21	10	RX8140M2
0.01-0.06 / 0.4-2.0 Micro-Bevel®	48,32	10	RX8150M2
0.02-0.08 / 0.4-2.0 Micro-Bevel®	183,94	10	RX8160M2

Cortantes diagonales con rendimiento específico de precisión con cabeza ovalada y mangos de seguridad ESD para materiales duros



8140PS-8161PS

	€		
0.01-0.04 / 0.1-1.0 Micro-Bevel®	36,70	10	8140PS
0.01-0.04 / 0.1-1.0 Flush	84,11	10	8141PS
0.00-0.05 / 0.1-1.25 Micro-Bevel®	43,39	10	8150PS
0.01-0.06 / 0.3-1.6 Micro-Bevel®	53,93	10	8160PS
0.01-0.06 / 0.3-1.6 Flush	52,90	10	8161PS

Cortantes diagonales de precisión con cabeza ovalada y mango de seguridad ESD con endurecido extra



8140M2-8160M2

	€		
0.01-0.05 / 0.4-2.0 Micro-Bevel®	45,40	10	8140M2
0.01-0.06 / 0.4-2.0 Micro-Bevel®	56,07	10	8150M2
0.02-0.08 / 0.4-2.0 Micro-Bevel®	74,40	10	8160 M2

Cortantes diagonales de precisión ERGO™ con cabeza cónica y mangos de seguridad ESD para materiales duros



ergo



RX8143PS-RX 8147PS

	€		
0.01-0.04 / 0.1-1.0 Flush	70,13	10	RX8143PS
0.004-0.03 / 0.1-0.8 Flush	93,60	10	RX 8147PS

ALICATES CORTE DIAGONAL RENDIMIENTO ESPECIFICO, CABEZA ESPECIAL

Alicates de corte diagonal de precisión ERGO™ con cabeza ovalada y punta rebajada



ergo



RX8140PSF-RX8160BPS

0.01-0.04 / 0.1-1.0 Micro-Bevel® € 66,66 10 RX8160BPS

Cortantes diagonales de precisión de rendimiento específico con cabeza ovalada



8154PSP

0.00-0.05 in Micro-Bevel® € 55,68 10 8154PSP

ALICATES DE MANIPULACIÓN DE PRECISIÓN

BOCA PLANA

Alicates de boca plana con mango sintético bi-componente



7490

Icon	Size	Price	Qty	Model
	20 mm	52,08	10	7490
	20 mm	62,78	10	7490 CO

Alicates de boca plana de precisión ERGO™ con mango sintético bi-componente



ergo



RX 7490

Icon	Size	Price	Qty	Model
	20 mm	68,31	10	RX 7490

Alicates de punta plana larga con mango sintético bi-componentes



HS 7490

Icon	Size	Price	Qty	Model
	S	101,13	10	HS7490

BOCA REDONDA

Alicates de boca redonda y de precisión ERGO™ con mango bi-componente sintético



ergo



RX 7590

Icon	Size	Price	Qty	Model
	20 mm	68,62	10	RX 7590

Alicates de boca redonda con mango sintético



7590-7591

Icon	Size	Price	Qty	Model
	20 mm	52,25	10	7590
	20 mm	68,41	10	7590 CO
	38.5 mm	26,99	1	7591

Alicates de punta redonda larga con mango sintético



HS 7590

Icon	Size	Price	Qty	Model
	S	69,65	1	HS 7590

BOCA CADENA

Alicates con boca semirredonda y punta curvada de 60° ERGO™ con mango sintético bi-componente

ergo



RX 7892

AT		€		
29 mm	M	80,54	10	RX 7892

Alicate de boca larga con mango sintético bi-componente



HS 7890-HS 7891

	€		
M	68,70	1	HS 7890
M	69,17	10	HS 7891

BOCA DOBLADA

Alicates de boca semirredonda de punta curvada de 60° con mango sintético



7892

AT		€		
20 mm	M	65,32	10	7892
20 mm	M	57,10	10	7892 CO

Alicates de boca semirredonda ERGO™ con mango sintético bi-componente

ergo



RX 7890-RX 7891

AT		€		
32 mm	S	72,15	10	RX 7890
32 mm	S	67,19	10	RX 7891

ALICATE PARA CREAR CADENAS DE JOYERIA

ERGO™ Alicate plano de precisión de punta recta para cadenas con mango sintético



ergo



RX 7390

AT		€		
11 mm	S	63,09	10	RX 7390

Alicate de punta larga de 60° doblada con mango sintético



HS 7892

	€		
M	72,99	1	HS 7892

Alicates de boca semirredonda con mango sintético bi-componente



7890-7891

AT		€		
32.5 mm	M	55,62	10	7890
32.5 mm	M	54,77	10	7891
32.5 mm	M	68,41	10	7890 CO
32.5 mm	M	62,48	10	7891 CO

ERGO™ Alicate plano de precisión de punta oblicua para cadenas con mango sintético



ergo



RX 7392

AT		€		
12 mm	S	63,09	10	RX 7392

BOCA SEMIRREDONDA, CABEZA ESPECIAL

Alicates de boca semirredonda corta ERGO™ con mango sintético bi-componente



ergo



RX 7893

AT		€		
20 mm	S	74,27	10	RX 7893

Alicates de boca semirredonda corta con mango sintético



7893

		€		
20 mm	S	53,55	10	7893

Alicates de boca semirredonda corta largos con mango sintético



HS 7893

	€		
S	103,04	1	HS 7893

BOCA SEMIRREDONDA, CABEZA ESPECIAL

Alicates de boca semirredonda dentada corta con mango sintético



7893K

		€		
20 mm	S	53,65	10	7893K

BOCA AGUJA

Alicates de precisión ERGO™ de boca semirredonda y punta fina



ergo



RX 7894

	€		
L	66,73	10	RX 7894

Alicate de boca de aguja larga con mango sintético



HS 7894

	€		
L	89,02	1	HS7894

Alicates de precisión de boca semirredonda y punta fina y mango de seguridad ESD



7894

	€		
L	26,06	10	7894

ALICATE DE PRECISIÓN

CABEZA AFILADA

Alicate de precisión Micro con cabeza cónica



6151

		€		
Micro Edge	0.2-1.6/0.01-0.06	22,99	10	6151

Alicate de precisión a ras con cabeza cónica



6152

		€		
Flush Edge	0.2-1.6/0.01-0.06	23,90	10	6152

Alicate de precisión a ras de acero inoxidable con cabeza cónica



6152SS

		€		
Flush Edge	0.2-1.6/0.01-0.06	27,90	10	6152SS

CABEZA PUNTIAGUDA

Alicate de precisión a ras con cabeza puntiaguda



6159



Flush Edge 0.2-1.0/0.01-0.039 € 10 6159

CABEZA OBLICUA

Alicate de precisión a ras con cabeza oblicua



6258



Flush Edge 0.2-1.0/0.01-0.039 € 10 6258

DESTORNILLADORES DE PRECISIÓN

ESD

Destornilladores planos ESD de precisión 1.5-3.0 mm



800ESD

Size	Length	Price	Quantity	Product Code
1.5 mm	50 mm	3,89	10	800-1.5-50ESD
2.0 mm	50 mm	5,92	10	800-2-50ESD
2.5 mm	50 mm	3,38	10	800-2.5-50ESD
3.0 mm	50 mm	3,21	10	800-3-50ESD

Destornilladores Phillips ESD de precisión PH00-PH1



801ESD

Size	Length	Price	Quantity	Product Code
PH00	50 mm	4,79	10	801-00-50ESD
PH0	50 mm	4,11	10	801-0-50ESD
PH1	75 mm	4,50	10	801-1-75ESD

Destornilladores TORX® ESD de precisión T6-T20



803ESD

Size	Length	Price	Quantity	Product Code
T6	50 mm	5,62	10	803-6-50ESD
T7	50 mm	5,86	10	803-7-50ESD
T8	50 mm	5,93	10	803-8-50ESD
T9	50 mm	7,58	10	803-9-50ESD
T10	50 mm	7,58	10	803-10-50ESD
T15	75 mm	7,67	10	803-15-75ESD
T20	75 mm	7,73	10	803-20-75ESD

Destornilladores Pentalobe ESD de precisión TS1-TS5



805ESD

Size	Length	Price	Quantity	Product Code
TS1	50 mm	8,35	10	805-TS1-50ESD
TS4	50 mm	6,33	10	805-TS4-50ESD
TS5	50 mm	8,90	10	805-TS5-50ESD

Juego de destornilladores planos/Phillips ESD de precisión 1.5-3.0mm/PH00-PH1 - 7 piezas



801-7ESD

Quantity	Price	Product Code
7	39,86	801-7ESD

800-1.5-50ESD, 800-2-50ESD, 800-2.5-50ESD, 800-3-50ESD

801-00-50ESD, 801-0-50ESD, 801-1-75ESD

Juego de destornilladores TORX® ESD de precisión T6-T20 - 7 piezas



803-7ESD

Quantity	Price	Product Code
7	41,10	803-7ESD

803-6-50ESD, 803-7-50ESD, 803-8-50ESD, 803-9-50ESD, 803-10-50ESD, 803-15-75ESD, 803-20-75ESD

▶ PELACABLES

ALICATES CORTE DIAGONAL

Alicates de corte diagonal de precisión con cabeza ovalada- Accesorio para pelado y mango de seguridad ESD



8150SK

		€		
0.01-0.06 / 0.3-1.6	Micro-Bevel®	71,02	10	8150 SK

Alicates de corte diagonal con corte ovalado o cabeza para pelado y mangos de seguridad ESD



8150J-8160J

		€		
0.02 / 0.5	Micro-Bevel®	106,66	10	8150 J
Max0.02 / Max	Micro-Bevel®	125,97	10	8160 J

▶ CORTANTES "HEAVY DUTY"

ALICATES CORTE DIAGONAL

Alicates de corte diagonal para industria pesada con mango bi-componente



TRX 8180

		€		
4.5 mm	2.5 mm	56,51	5	TRX 8180

▶ HERRAMIENTAS DINAMOMÉTRICAS

DESTORNILLADORES DINAMOMÉTRICOS

Destornilladores dinámicos ajustables con visor de escala y seguridad ESD



MA500-1A - MA500-3A

		€		
16-80 cNM	1/4 in	273,26	1	MA500-1A
40-200 cNM	1/4 in	279,60	1	MA500-2A
90-450 cNM	1/4 in	285,74	1	MA500-3A

Destornilladores dinámicos preajustados con visor de escala y seguridad ESD



PS501

		€		
4-22 cNM	1/4 in	197,83	1	PS501-1
7-70 cNM	1/4 in	220,37	1	PS501-2
15-170 cNM	1/4 in	227,89	1	PS501-3
45-450 cNM	1/4 in	234,15	1	PS501-4



PINZAS

JUEGOS DE PINZAS

Juego de 5 pinzas estilo SS-SA, 2A-SA, 7A-SA, AA-SA



9855

8 x 200 x 110 mm € 100,74 1 9855

- 9855W
- TL SS-SA-SL
- TL AA-SA-SL
- TL 2A-SA-SL
- TL 7A-SA-SL
- TL 4-SA-SL

Juego de 5 pinzas estilo 00-SA, 1-SA, 3C-SA, 5-SA, 7-SA



9857

10 x 200 x 110 mm € 78,72 1 9857

- TL 00-SA-SL
- TL 1-SA-SL
- TL 5-SA-SL
- TL 7-SA-SL
- TL 3C-SA-SL
- 9855W

Juego de 2 pinzas estilo AA-SA, SS-SA



9858

8 x 200 x 65 mm € 29,25 1 9858

- 9858W
- TL AA-SA-SL
- TL SS-SA-SL

Juego de 2 pinzas estilo 00B-SA, 2A-SA



9859

8 x 200 x 65 mm € 67,60 1 9859

- 9858W
- TL 00B-SA
- TL 2A-SA-SL

Juego de 5 pinzas de alta precisión estilo 00-SA, 2ASA, 3C-SA, 5-SA, 7-SA



9860

12 x 105 x 185 mm € 154,72 1 9860

Juego de 5 pinzas gama económica Estilo de punta 00-SA, 2A-SA, 3C-SA, 5-SA, 7-SA



9861

10 x 70 x 165 mm € 68,89 1 9861

Juego de 4 pinzas gama económica estilo 2A-SA, 3C-SA, 7A-SA, AA-SA



9862

10 x 70 x 165 mm € 54,46 1 9862

Juego de 5 pinzas SMD y gama económica Estilo de punta SM103-SA, SM108-SA, 3-SA, 5-SA, 7A-SA



9863

10 x 70 x 165 mm € 92,23 1 9863

PINZAS DE CORTE

Pinzas de corte de acero al carbono estilo 15A con hojas en ángulo



TL 15A

		€		
15A	120 mm	53,54	1	TL 15A

Pinzas de corte de acero al carbono estilo 15AGW con hojas predominantemente angulares



TL 15AGW

		€		
15AGW	115 mm	53,46	1	TL 15AGW

Pinzas de corte de acero inoxidable estilo 15AGWHM con insertos de carburo de tungsteno y hojas predominantemente angulares



TL 15AGWHM-SA

		€		
15AGHM	115 mm	90,48	1	TL 15AGWHM-SA

PINZAS DE PRECISIÓN

Pinzas de acero inoxidable de alta precisión estilo 00B con mangos dentados y puntas gruesas y resistentes



TL 00B-SA

		€		
00B	120 mm	42,47	1	TL 00B-SA

Pinzas de acero inoxidable de alta precisión estilo 00D con mangos dentados, gruesas, fuertes, puntas dentadas de línea



TL 00D-SA

		€		
00D	120 mm	42,47	1	TL 00D-SA

Acero inox, anti-magnético, anti-ácido

Pinzas de acero inoxidable de alta precisión estilo 00 con puntas gruesas y resistentes



TL 00-SA

		€		
00	120 mm	38,26	1	TL 00-SA

Acero inox, anti-magnético, anti-ácido

Pinzas de acero inoxidable de alta precisión estilo 000 con puntas finas



TL 000-SA

		€		
000	120 mm	30,99	1	TL 000-SA

Pinzas de acero inoxidable de alta precisión estilo 0C9 con puntas finas y afiladas



TL 0C9-SA

		€		
0C9	90 mm	36,70	1	TL 0C9-SA

Acero inox, anti-magnético, anti-ácido

Pinzas de acero inoxidable de alta precisión estilo 1 con puntas finas y afiladas



TL 1-SA

		€		
1	120 mm	36,70	1	TL 1-SA

Acero inox, anti-magnético, anti-ácido

Pinzas de acero inoxidable de alta precisión estilo 2A con puntas muy finas, redondas y planas



TL 2A-SA

		€		
2A	120 mm	37,50	1	TL 2A-SA

Acero inox, anti-magnético, anti-ácido

Pinzas de acero inoxidable de alta precisión estilo 3C con puntas finas y puntiagudas



TL 3C-SA

		€		
3C	110 mm	36,70	1	TL 3C-SA

Acero inox, anti-magnético, anti-ácido

Pinzas de acero inoxidable de alta precisión estilo 3 con puntas finas y puntiagudas



TL 3-SA

		€		
3	120 mm	36,70	1	TL 3-SA

Acero inox, anti-magnético, anti-ácido

Pinzas de acero inoxidable de alta precisión estilo 51S con puntas dobladas y muy finas



TL 51S-SA

		€		
51S	115 mm	41,21	1	TL 51S-SA

Acero inox, anti-magnético, anti-ácido

Pinzas de acero inoxidable de alta precisión estilo 5 con puntas afiladas muy finas



TL 5-SA

		€		
5	110 mm	44,49	1	TL 5-SA

Acero inox, anti-magnético, anti-ácido

Pinzas de acero inoxidable de alta precisión estilo SS con puntas muy finas y muy afiladas



TL SS-SA

		€		
SS	140 mm	36,70	1	TL SS-SA

Acero inox, anti-magnético, anti-ácido

Pinzas de acero inoxidable de alta precisión estilo 7A con puntas muy finas y curvadas



TL 7A-SA

		€		
7A	118 mm	47,77	1	TL 7A-SA

Acero inox, anti-magnético, anti-ácido

Pinzas de acero inoxidable de alta precisión estilo 7 con puntas muy finas y curvadas



TL 7-SA

		€		
7	118 mm	47,77	1	TL 7-SA

Acero inox, anti-magnético, anti-ácido

Pinzas de acero inoxidable de alta precisión estilo 5B con puntas dobladas, muy finas y afiladas



TL 5B-SA

		€		
5B	110 mm	47,77	1	TL 5B-SA

Acero inox, anti-magnético, anti-ácido

Pinzas de acero inoxidable de alta precisión estilo 65A con puntas dobladas, muy finas y muy afiladas



TL 65A-SA

		€		
65A	140 mm	42,85	1	TL 65A-SA

Acero inox, anti-magnético, anti-ácido

Pinzas de acero inoxidable de alta precisión estilo 34A con mangos dentados y puntas planas, finas y cuadradas



TL 34A-SA

		€		
34A	120 mm	40,53	1	TL 34A-SA

Pinzas de acero inoxidable de alta precisión estilo 6 con puntas anguladas y muy finas



TL 6-SA

		€		
6	117 mm	40,53	1	TL 6-SA

Acero inox, anti-magnético, anti-ácido

PINZAS DE PLÁSTICO DE PUNTA REEMPLAZABLE - FIBRA DE CARBONO

Pinzas de plástico de fibra de carbono de punta reemplazable ESD Safe Style 242CFR con puntas finas



TL 242CFR-SA

		€		
242CFR	130 mm	26,85	1	TL 242CFR-SA

Pinzas de plástico de fibra de carbono con punta reemplazable y segura para ESD, estilo 249CFR, con puntas gruesas, biseladas y resistentes



TL 249CFR-SA

		€		
249CFR	130 mm	50,18	1	TL 249CFR-SA

Cuerpo de acero inox

Pinzas de plástico de fibra de carbono con punta reemplazable y segura para ESD, estilo 259CFR, con puntas finas, puntiagudas y fuertes



TL 259CFR-SA

		€		
259CFR	130 mm	50,18	1	TL 259 CFR-SA

Cuerpo de acero inox

Pinzas de plástico PEEK de carbono con punta reemplazable y segura para ESD, estilo 259CPR con puntas finas, puntiagudas y fuertes



TL 259CPR-SA

		€		
259CPR	130 mm	28,11	1	TL 259CPR-SA

Pinzas de plástico PEEK de carbono con punta reemplazable y segura para ESD, estilo 259CPR con puntas finas, puntiagudas y fuertes



TL 259CPR-SA

		€		
259CPR	130 mm	28,11	1	TL 259CPR-SA

Pinzas de plástico de fibra de carbono de punta reemplazable ESD Safe Style 00CFR con puntas gruesas y cuadradas



TL 00CFR-SA

		€		
00CFR	130 mm	50,18	1	TL 00CFR-SA

Cuerpo de acero inox

Pinzas de plástico de PVDF con punta reemplazable y segura para ESD, estilo 259SVR con puntas finas, puntiagudas y fuertes



TL 259SVR-SA

		€		
259SVR	130 mm	42,18	1	TL 259SVR-SA

Pinzas de plástico de fibra de carbono de punta reemplazable ESD segura estilo 2ACFR con puntas planas muy finas y redondas



TL 2ACFR-SA

		€		
2ACFR	130 mm	50,18	1	TL 2ACFR-SA

Cuerpo de acero inox

Pinzas de plástico de fibra de carbono con punta reemplazable y segura ESD estilo 5CF con puntas muy finas y afiladas



TL 5CF-SA

		€		
5CF	130 mm	25,72	1	TL 5CF-SA

Pinzas de plástico de fibra de carbono con punta reemplazable y segura ESD estilo 5CFR con puntas muy finas y afiladas



TL 5CFR-SA

		€		
5CFR	130 mm	50,18	1	TL 5CFR-SA

Cuerpo de acero inox

Pinzas de plástico de carbono PEEK con punta reemplazable y segura ESD estilo 5CPR con puntas muy finas y afiladas



TL 5CPR-SA

		€		
5CPR	130 mm	28,11	1	TL 5CPR-SA

Pinzas de plástico de PVDF con punta reemplazable y seguridad ESD estilo 5SV con puntas muy finas y afiladas



TL 5SVR-SA

		€		
5SVR	130 mm	28,11	1	TL 5SVR-SA

Pinzas de plástico PEEK de carbono con punta reemplazable y segura para ESD, estilo 7CPR con puntas muy finas y curvadas



TL 7CPR-SA

		€		
7CPR	130 mm	28,11	1	TL 7CPR-SA

Pinzas de plástico de PVDF con punta reemplazable y segura para ESD estilo 7SVR con puntas muy finas y curvadas



TL 7SVR-SA

		€		
7SVR	130 mm	28,11	1	TL 7SVR-SA

Pinzas de plástico de fibra de carbono con punta reemplazable y segura ESD estilo 7CFR con puntas muy finas y curvadas



TL 7CFR-SA

		€		
7CFR	130 mm	50,18	1	TL 7CFR-SA

Cuerpo acero inox

PINZAS TÁCTILES ERGONÓMICAS CON SEGURIDAD ESD

Pinzas ergonómicas de acero inoxidable ESD estilo 00 con puntas gruesas y resistentes



TL 00-SA-ET

		€		
00-SA	123 mm	45,11	1	TL 00-SA-ET

Pinzas ergonómicas de acero inoxidable ESD estilo 2A con puntas redondas, planas y muy finas



TL 2A-SA-ET

		€		
2A-SA	123 mm	34,26	1	TL 2A-SA-ET

Pinzas ergonómicas de acero inoxidable ESD Style 3 con puntas afiladas y finas



TL 3-SA-ET

		€		
3	123 mm	45,11	1	TL 3-SA-ET

Pinzas ergonómicas de acero inoxidable ESD estilo 3C con puntas puntiagudas y finas



TL 3C-SA-ET

		€		
3C-SA	112 mm	34,63	1	TL 3C-SA-ET

Pinzas ergonómicas de acero inoxidable ESD Style 5 con puntas afiladas y finas



TL 5-SA-ET

		€		
5-SA	112 mm	38,14	1	TL 5-SA-ET

Pinzas ergonómicas de acero inoxidable ESD estilo AA con puntas afiladas y finas



TL AA-SA-ET

		€		
AA-SA	130 mm	27,99	1	TL AA-SA-ET

Pinzas ergonómicas ESD de acero inoxidable estilo SM116 con puntas ranuradas para el posicionamiento de dispositivos cilindricos verticales



TL SM116-SA-ET

		€		
SM116	115 mm	40,53	1	TL SM116-SA-ET

Pinzas ergonómicas de acero inoxidable ESD estilo 7A con puntas curvas y finas



TL 7A-SA-ET

		€		
7A	122 mm	40,03	1	TL 7A-SA-ET

Pinzas ergonómicas de acero inoxidable ESD Style 7 con puntas curvadas y muy finas



TL 7-SA-ET

		€		
7-SA	122 mm	40,03	1	TL 7-SA-ET

PINZAS ECONÓMICAS

Pinzas gama económica de acero inoxidable estilo 00 con puntas gruesas y resistentes



TL 00-SA-SL

		€		
00	120 mm	19,11	5	TL 00-SA-SL

Pinzas gama económica de acero inoxidable estilo 1 con puntas afiladas y finas



TL 1-SA-SL

		€		
1	120 mm	18,36	5	TL 1-SA-SL

Pinzas gama económica de acero inoxidable estilo 2A con puntas redondas planas y finas



TL 2A-SA-SL

		€		
2A	118 mm	18,76	5	TL 2A-SA-SL

Pinzas gama económica de acero inoxidable estilo 2 con puntas puntiagudas y muy finas



TL 2-SA-SL

		€		
2	120 mm	18,76	5	TL 2-SA-SL

Pinzas gama económica de acero inoxidable estilo 3C con puntas puntiagudas y finas



TL 3C-SA-SL

		€		
3C	110 mm	18,36	5	TL 3C-SA-SL

Pinzas gama económica de acero inoxidable estilo 3 con puntas puntiagudas y finas



TL 3-SA-SL

		€		
3	125 mm	18,36	5	TL 3-SA-SL

Puntas muy afiladas

Pinzas gama económica de acero inoxidable estilo 4 con puntas afiladas y finas



TL 4-SA-SL

		€		
4	110 mm	20,40	5	TL 4-SA-SL

Pinzas gama económica de acero inoxidable estilo 5A con puntas afiladas y finas



TL 5A-SA-SL

		€		
5A	110 mm	22,26	5	TL 5A-SA-SL

Acero inox, anti-magnético, anti-ácido

Pinzas gama económica de acero inoxidable estilo 5A con puntas afiladas y finas



TL 5-SA-SL

		€		
5	110 mm	22,26	5	TL 5-SA-SL

Acero inox, anti-magnético, anti-ácido

Pinzas gama económica de acero inoxidable estilo AC con mangos dentados y puntas resistentes



TL AC-SA-SL

		€		
AC	110 mm	18,40	5	TL AC-SA-SL

Pinzas gama económica de acero inoxidable estilo SS con puntas muy afiladas y finas



TL SS-SA-SL

		€		
SS	140 mm	18,36	5	TL SS-SA-SL

Pinzas gama económica de acero inoxidable estilo AA con puntas afiladas y finas



TL AA-SA-SL

		€		
AA	128 mm	11,21	5	TL AA-SA-SL

Acero inox, anti-magnético, anti-ácido

Pinzas gama económica de acero inoxidable estilo MM con puntas afiladas, fuertes y finas



TL MM-SA-SL

		€		
MM	125 mm	11,21	5	TL MM-SA-SL

Acero inox, anti-magnético, anti-ácido

Pinzas gama económica de acero inoxidable estilo 7A con puntas curvas y finas



TL 7A-SA-SL

		€		
7A	120 mm	24,07	5	TL 7A-SA-SL

Acero inox, anti-magnético, anti-ácido

Pinzas gama económica de acero inoxidable estilo 7 con puntas curvas y finas



TL 7-SA-SL

		€		
7	120 mm	23,87	5	TL 7-SA-SL

PINZAS SMD

Pinzas de acero inoxidable estilo SMD 104 para posicionar paquetes SOT y condensadores de chip monolíticos



TL SM104-SA

		€		
SM104	120 mm	40,25	1	TL SM 104-SA

Pinzas de acero inoxidable estilo SMD 105 con puntas en forma de martillo para el posicionamiento de paquetes SOT verticales



TL SM105-SA

		€		
SM105	120 mm	40,25	1	TL SM 105-SA

Acero inox, anti-magnético, anti-ácido

Pinzas de acero inoxidable estilo SMD 106 con puntas finas para el posicionamiento de paquetes SOT horizontales



TL SM106-SA

		€		
SM106	120 mm	23,71	1	TL SM106-SA

Pinzas de acero inoxidable estilo SMD 108 para soldar componentes de 1 mm de ancho



TL SM108-SA

		€		
SM108	120 mm	40,25	1	TL SM 108-SA

Pinzas de acero inoxidable estilo SMD 109 para soldar componentes de 1 mm de ancho en ángulo de 45°



TL SM109-SA

		€		
SM109	120 mm	40,25	1	TL SM 109-SA

Acero inox, anti-magnético, anti-ácido

Pinzas de acero inoxidable estilo SMD 110 con puntas ranuradas para el posicionamiento de dispositivos cilíndricos



TL SM110-SA

		€		
SM110	120 mm	40,25	1	TL SM 110-SA

Acero inox, anti-magnético, anti-ácido

Pinzas de acero inoxidable estilo SMD 111 con puntas ranuradas para posicionar dispositivos cilíndricos de 0,5 mm



TL SM111-SA

		€		
SM111	115 mm	40,25	1	TL SM 111-SA

Acero inox, anti-magnético, anti-ácido

Pinzas de acero inoxidable estilo SMD 116 con puntas ranuradas para el posicionamiento de dispositivos cilíndricos verticales



TL SM116-SA

		€		
SM116	115 mm	23,71	1	TL SM116-SA

Pinzas de acero inoxidable estilo SMD 107 con puntas doblemente dobladas para posicionar dispositivos planos



TL SM107-SA

		€		
SM107	120 mm	40,25	1	TL SM 107-SA

Acero inox, anti-magnético, anti-ácido

Pinzas de acero inoxidable estilo SMD 103 para manipular y posicionar en ángulo de 45°



TL SM103-SA

		€		
SM103	115 mm	40,25	1	TL SM 103-SA

Pinzas de acero inoxidable estilo SMD 115 con puntas acanaladas a 45° para posicionar dispositivos cilindricos de 0,6 mm



TL SM115-SA

		€		
SM115	115 mm	40,25	1	TL SM 115-SA

Acero inox, anti-magnético, anti-ácido

Pinzas de acero inoxidable estilo SMD 117 con puntas cuadradas en ángulo de 20° para posicionar paquetes SOT



TL SM117-SA

		€		
SM117	120 mm	40,25	1	TL SM 117-SA

Acero inox, anti-magnético, anti-ácido

COMPONENTES PINZAS DE POSICIONAMIENTO

Pinzas de posicionamiento con componentes de acero inoxidable estilo 578 con mangos dentados y puntas ranuradas para dispositivos cilindricos de 2 mm



TL 578-SA

		€		
578	120 mm	32,84	1	TL 578-SA

Acero inox, anti-magnético, anti-ácido

Pinzas de posicionamiento con componentes de acero inoxidable estilo 582 con mangos dentados y puntas ranuradas para dispositivos cilindricos de 1 mm



TL 582-SA

		€		
582	115 mm	32,84	1	TL 582-SA

Acero inox, anti-magnético, anti-ácido

PINZAS UNIVERSALES

Pinzas de acero inoxidable de uso general estilo 475 con mangos dentados y puntas biseladas, fuertes y dentadas de línea



TL 475-SA

		€		
475	136 mm	37,41	1	TL 475-SA

Anti-magnético, anti-ácido

Pinzas de acero inoxidable de uso general estilo 648 con mangos dentados y puntas biseladas, gruesas, fuertes y afiladas



TL 648-SA

		€		
648	155 mm	33,53	1	TL 648-SA

Con un pin para mejor alineamiento Acero inox, antimagnético, anti-ácido

Pinzas de acero inoxidable de uso general estilo 124 con mangos dentados y puntas dobladas, dentadas en forma de rombo, finas



TL 124-SA

		€		
124	150 mm	31,57	1	TL 124-SA

Acero inox, anti magnético, anti ácido

Pinzas de acero inoxidable de uso general estilo 649 con mangos dentados y puntas dobladas, biseladas, gruesas y fuertes, dentadas en línea



TL 649-SA

		€		
649	154 mm	33,44	1	TL 649-SA

Acero inox, anti-magnética, anti-ácido

REPUESTOS Y ACCESORIOS

Juego de 2 tornillos de fibra de carbono y 3 tornillos con puntas rectas, gruesas y resistentes TL 00CFR-SA



TL 00ACF

		€		
00CFR	40 mm	7,90	1	TL 00ACF

Juego de 2 puntas de fibra de carbono y 3 tornillos con puntas rectas, muy finas, redondas y planas para TL 2ACFR-SA-TL 2AXCFR-SA



TL 2AACF

		€		
2A	40 mm	15,16	1	TL 2AACF

Juego de 2 puntas de fibra de carbono y 3 tornillos con puntas rectas abd finas para TL 242CFR-SA



TL 242ACF

		€		
242CFR	40 mm	7,90	1	TL 242ACF

Juego de 2 puntas de fibra de carbono y 3 tornillos con puntas rectas, gruesas, biseladas y resistentes para TL 249CFR-SA



TL 249ACF

		€		
249CFR	40 mm	15,16	1	TL 249 ACF

Juego de 2 puntas de carbono PEEK y 3 tornillos con puntas rectas, finas, puntiagudas y fuertes para TL 259CPR-SA



TL 259ACP

		€		
259CPR	40 mm	106,79	1	TL 259ACP

Juego de 2 puntas de PVDF y 3 tornillos con puntas rectas, finas, puntiagudas y fuertes para TL 259SVR-SA



TL 259ASV

		€		
259ASV	40 mm	13,03	1	TL 259ASV

Juego de 2 puntas de fibra de carbono y 3 tornillos con puntas rectas, finas, puntiagudas y fuertes para TL 259CFR-SA



TL 259ACF

		€		
259CFR	40 mm	15,16	1	TL 259 ACF

Juego de 2 puntas de PVDF y 3 tornillos y puntas rectas, muy finas y afiladas para TL 5SVR-SA-TL 5XSVR-SA



TL 5ASV

		€		
5SVR	40 mm	106,79	1	TL 5ASV

Juego de 2 puntas de fibra de carbono y 3 tornillos con puntas rectas, muy finas y afiladas para TL 5CFR-SA-TL 5XCFR-SA



TL 5ACF

		€		
5CF	40 mm	15,16	1	TL 5ACF

Juego de 2 puntas de fibra de carbono y 3 tornillos con puntas curvas y muy finas para TL 7CFR-SA



TL 7ACF

		€		
7CFR	40 mm	15,16	1	TL 7ACF

Juego de 2 puntas de carbono PEEK y 3 tornillos con puntas rectas, muy finas y afiladas para TL 5CPR-SA-TL 5XCPR-SA



TL 5ACP

		€		
5CPR	40 mm	106,79	1	TL 5ACP

Juego de 2 puntas de PVDF y 3 tornillos con puntas curvas y muy finas para TL 7SVR-SA



TL 7ASV

		€		
7SVR	40 mm	106,79	1	TL 7ASV

Juego de 2 puntas de carbono PEEK y 3 tornillos con puntas curvas y muy finas para TL 7CPR-SA



TL 7ACP

		€		
7CPR	40 mm	106,79	1	TL 7ACP



1-100-04-1-0	7311518019006	10	5,50	22
1-100-04-1-2	7311518244125	5	6,91	22
1-100-04-2-0	7311518019013	10	4,93	22
1-100-04-2-2	7311518244132	5	7,05	22
1-100-04-3-0	7311518019020	10	5,13	22
1-100-06-1-0	7311518019037	10	5,13	22
1-100-06-1-2	7311518000233	5	8,73	22
1-100-06-2-0	7311518019044	10	5,48	22
1-100-06-2-2	7311518003593	5	8,81	22
1-100-06-3-0	7311518019051	10	5,68	22
1-100-06-3-2	7311518293581	5	8,80	22
1-100-08-1-0	7311518019068	10	6,64	22
1-100-08-1-2	7311518000264	5	9,55	22
1-100-08-2-0	7311518019075	10	7,05	22
1-100-08-2-2	7311518003609	5	10,01	22
1-100-08-3-0	7311518019082	10	7,16	22
1-100-08-3-2	7311518295585	5	11,13	22
1-100-10-1-0	7311518019099	10	8,67	22
1-100-10-1-2	7311518000295	5	12,33	22
1-100-10-2-0	7311518019105	10	9,07	22
1-100-10-2-2	7311518003616	5	12,72	22
1-100-10-3-0	7311518019112	10	9,21	22
1-100-10-3-2	7311518295592	5	12,07	22
1-100-12-1-0	7311518019129	5	11,84	22
1-100-12-1-2	7311518028053	5	15,21	22
1-100-12-2-0	7311518019136	5	12,11	22
1-100-12-2-2	7311518244118	5	15,48	22
1-100-12-3-0	7311518019143	5	12,25	22
1-100-12-3-2	7311518295608	5	14,23	22
1-100-14-1-0	7311518019150	5	16,93	22
1-100-14-2-0	7311518019167	5	17,73	22
1-102-06-2-0	7311518019198	10	7,72	22
1-102-06-3-0	7311518019204	10	8,13	22
1-102-08-1-0	7311518019211	10	9,21	22
1-102-08-2-0	7311518019228	10	9,55	22
1-102-08-3-0	7311518019235	10	9,67	22
1-104-10-2-0	7311518019242	10	14,89	22
1-104-10-3-0	7311518019259	10	15,42	22
1-104-12-2-0	7311518019266	5	19,91	22
1-104-12-3-0	7311518019273	5	21,39	22
1-104-14-3-0	7311518019297	5	28,96	22
1-106-08-1-0	7311518019303	10	10,90	22
1-106-08-1-2	7311518000301	5	14,31	22
1-106-10-1-0	7311518019310	10	15,17	22
1-106-10-1-2	7311518000325	5	18,32	22
1-106-12-1-0	7311518019327	5	19,37	22
1-106-12-1-2	7311518295615	5	22,11	22
1-110-04-1-0	7311518019334	10	4,69	22
1-110-04-2-0	7311518019341	10	4,93	22
1-110-04-3-0	7311518044046	10	5,13	22
1-110-06-1-0	7311518019358	10	5,13	22
1-110-06-1-2	7311518295622	5	8,73	23
1-110-06-2-0	7311518019365	10	5,48	22
1-110-06-2-2	7311518003623	5	8,81	23
1-110-06-3-0	7311518019372	10	5,68	22
1-110-06-3-2	7311518295639	5	8,71	23
1-110-08-1-0	7311518019389	10	6,64	22
1-110-08-1-2	7311518000332	5	9,55	23
1-110-08-2-0	7311518019396	10	7,05	22
1-110-08-2-2	7311518003630	5	10,01	23
1-110-08-3-0	7311518019402	10	7,16	22
1-110-08-3-2	7311518295646	5	10,09	23
1-110-10-1-0	7311518019419	10	8,67	22
1-110-10-1-2	7311518000349	5	12,33	23
1-110-10-2-0	7311518019426	10	9,07	22
1-110-10-2-2	7311518003647	5	12,72	23
1-110-10-3-0	7311518019433	10	9,21	22
1-110-10-3-2	7311518295653	5	11,57	23
1-110-12-1-0	7311518019440	5	11,84	22
1-110-12-1-2	7311518295660	5	14,05	23
1-110-12-2-0	7311518019457	5	12,11	22
1-110-12-2-2	7311518295677	5	16,38	23
1-110-12-3-0	7311518019464	5	12,25	22
1-110-12-3-2	7311518295684	5	14,42	23
1-110-14-1-0	7311518019488	5	16,93	22
1-111-04-1-0	7311518044053	10	5,13	23
1-111-04-2-0	7311518019518	10	5,41	23
1-111-04-3-0	7311518019525	10	5,60	23
1-111-06-1-0	7311518019549	10	5,60	23
1-111-06-2-0	7311518019556	10	6,42	23
1-111-06-2-2	7311518000363	5	9,90	23
1-111-06-3-0	7311518019563	10	6,64	23
1-111-08-1-0	7311518019570	10	7,84	23
1-111-08-2-0	7311518019587	10	8,88	23
1-115-11-3-1	7311518003791	10	10,45	23
1-143-04-1-0	7311518105983	10	4,25	23
1-143-06-1-0	7311518019631	10	4,62	23
1-143-06-1-2	7311518022341	5	8,53	23
1-143-08-1-0	7311518019662	10	5,96	23
1-143-08-1-2	7311518028077	5	9,82	23
1-143-10-1-0	7311518019693	10	7,84	23
1-143-10-1-2	7311518022358	5	11,71	23
1-143-12-1-0	7311518019723	5	10,70	23
1-143-12-1-2	7311518295691	5	14,75	23
1-160-04-1-0	7311518019785	10	5,58	25
1-160-04-1-2	7311518244057	5	7,88	25



1-160-04-2-0	7311518019792	10	5,83	25
1-160-04-2-2	7311518244095	5	8,24	25
1-160-04-3-0	7311518019808	10	5,96	25
1-160-06-1-0	7311518019815	10	5,38	25
1-160-06-1-2	7311518000370	5	8,67	25
1-160-06-2-0	7311518019822	10	5,79	25
1-160-06-2-2	7311518003685	5	8,73	25
1-160-06-3-0	7311518019839	10	6,01	25
1-160-06-3-2	7311518295707	5	9,13	25
1-160-08-1-0	7311518019846	10	6,45	25
1-160-08-1-2	7311518000394	5	9,76	25
1-160-08-2-0	7311518019853	10	6,76	25
1-160-08-2-2	7311518003692	5	10,17	25
1-160-08-3-0	7311518019860	10	6,91	25
1-160-08-3-2	7311518295714	5	11,67	25
1-160-10-1-0	7311518019877	10	9,14	25
1-160-10-1-2	7311518000400	5	12,06	25
1-160-10-2-0	7311518019884	10	9,60	25
1-160-10-2-2	7311518295721	5	12,87	25
1-160-10-3-0	7311518019891	10	9,76	25
1-160-10-3-2	7311518295738	5	14,21	25
1-160-12-1-0	7311518019907	5	13,13	25
1-160-12-1-2	7311518295745	5	17,37	25
1-160-12-2-0	7311518019914	5	13,67	25
1-160-12-2-2	7311518295752	5	17,02	25
1-160-12-3-0	7314150292059	5	16,10	25
1-160-12-3-2	7311518298005	5	17,17	25
1-170-04-1-0	7311518044060	10	5,40	24
1-170-04-2-0	7311518019945	10	5,43	24
1-170-04-2-2	7311518244088	5	8,73	24
1-170-04-3-0	7311518019952	10	5,79	24
1-170-06-1-0	7311518019969	10	6,07	24
1-170-06-1-2	7311518244071	5	8,97	24
1-170-06-2-0	7311518019976	10	6,46	24
1-170-06-2-2	7311518003715	5	9,44	24
1-170-06-3-0	7311518019983	10	6,64	24
1-170-06-3-2	7311518295769	5	10,72	24
1-170-08-1-0	7311518019990	10	8,00	24
1-170-08-1-2	7311518000417	5	11,30	24
1-170-08-2-0	7311518020002	10	8,47	24
1-170-08-2-2	7311518003722	5	11,71	24
1-170-08-3-0	7311518020019	10	8,67	24
1-170-08-3-2	7311518295783	5	13,92	24
1-170-10-1-0	7311518020026	10	11,30	24
1-170-10-1-2	7311518028107	5	14,57	24
1-170-10-2-0	7311518020033	10	11,78	24
1-170-10-2-2	7311518244064	5	14,60	24
1-170-10-3-0	7311518020040	10	12,06	24
1-170-10-3-2	7311518295806	5	17,76	24
1-170-12-1-0	7311518020057	5	14,60	24
1-170-12-2-0	7311518020064	5	15,83	24
1-210-04-1-0	7311518020071	10	8,06	24
1-210-04-1-2	7311518243944	5	10,01	24
1-210-04-2-0	7311518020088	10	8,13	24
1-210-04-2-2	7311518244040	5	10,01	24
1-210-04-3-0	7311518020095	10	8,24	24
1-210-06-1-0	7311518020101	10	8,24	24
1-210-06-1-2	7311518000424	5	10,44	24
1-210-06-2-0	7311518020118	10	8,47	24
1-210-06-2-2	7311518003654	5	10,63	24
1-210-06-3-0	7311518020125	10	8,60	24
1-210-06-3-2	7311518293574	5	11,30	24
1-210-08-1-0	7311518020132	10	10,17	24
1-210-08-1-2	7311518000455	5	11,98	24
1-210-08-2-0	7311518020149	10	10,36	24
1-210-08-2-2	7311518000479	5	12,87	24
1-210-08-3-0	7311518020156	10	10,56	24
1-210-08-3-2	7311518295837	5	11,67	24
1-210-10-1-0	7311518020163	10	12,38	24
1-210-10-1-2	7311518000493	5	16,13	24
1-210-10-2-0	7311518020170	10	12,78	24
1-210-10-2-2	7311518003661	5	16,93	24
1-210-10-3-0	7311518020187	10	13,06	24
1-210-10-3-2	7311518295844	5	14,21	24
1-210-12-1-0	7311518020194	5	18,42	24
1-210-12-1-2	7311518028121	5	21,71	24
1-210-12-2-0	7311518020200	5	18,82	24
1-210-12-2-2	7311518244149	5	21,95	24
1-210-12-3-0	7311518020217	5	19,08	24
1-210-12-3-2	7311518295851	5	23,50	24
1-210-14-1-0	7311518020224	5	25,44	24
1-230-04-1-0	7311518020248	10	4,82	24
1-230-04-1-2	7311518244163	5	6,65	24
1-230-04-2-0	7311518020255	10	5,08	24
1-230-04-2-2	7311518244156	5	6,96	24
1-230-04-3-0	7311518020262	10	5,21	24
1-230-06-1-0	7311518020279	10	5,41	24
1-230-06-1-2	7311518000509	5	7,88	24
1-230-06-2-0	7311518020286	10	5,68	24
1-230-06-2-2	7311518000523	5	8,05	24
1-230-06-3-0	7311518020293	10	5,79	24
1-230-06-3-2	7311518293567	5	7,73	24
1-230-08-1-0	7311518020309	10	6,42	24
1-230-08-1-2	7311518000547	5	8,88	24
1-230-08-2-0	7311518020316	10	6,82	24
1-230-08-2-2	7311518000554	5	9,21	24





1-230-08-3-0	7311518020323	10	7,12	24
1-230-08-3-2	7311518295882	5	8,92	24
1-230-10-1-0	7311518020330	10	7,84	24
1-230-10-1-2	7311518000578	5	11,25	24
1-230-10-2-0	7311518020347	10	8,73	24
1-230-10-2-2	7311518003678	5	11,78	24
1-230-10-3-0	7311518020354	10	9,35	24
1-230-10-3-2	7311518295899	5	11,52	24
1-230-12-1-0	7311518020361	5	10,90	24
1-230-12-1-2	7311518295912	5	13,90	24
1-230-12-2-0	7311518020378	5	11,52	24
1-230-12-2-2	7311518295929	5	13,90	24
1-230-12-3-0	7311518020385	5	11,71	24
1-230-12-3-2	7311518295905	5	13,36	24
1-320-08-2-0	7311518191276	10	17,73	23
1-320-08-2-2	7311518270865	5	21,45	23
1-320-10-2-0	7311518020477	10	19,63	23
1-320-10-2-2	7311518270872	5	23,41	23
1-320-12-2-0	7311518020484	5	21,64	23
1-473-06-2-2	7311518201098	5	28,47	25
1-473-08-2-2	7311518201104	5	32,87	25
1-473-10-2-2	7311518201111	5	38,72	25
1-476-04-3-2	7311518010928	1	49,10	25
1-477-08-2-2	7311518037994	5	58,08	25
1-477-10-2-2	7311518201074	5	69,77	26
1-478-08-1-2	7311518141127	5	52,63	26
1-478-10-1-2	7311518241995	5	62,64	26
1-479-08-1-2	7311518176747	5	61,85	26
1-479-08-2-2	7311518180607	5	62,90	26
10-21-51	7311518229344	5	15,49	633
10-24-23	7311518229368	5	16,64	633
10-24-51	7311518229351	5	16,63	633
10-30-23	7311518229382	5	18,81	633
10-30-51	7311518229375	5	20,24	633
1016	7314150218189	10	4,69	218
1019	8412814010199	10	4,63	218
1031-10	7314150025442	5	26,68	571
1031-12	7314150025459	5	27,37	571
1031-14	7314150025466	5	27,91	571
1031-16	7314150025473	5	28,45	571
1031-18	7314150025480	5	29,12	571
1031-20	7314150025497	5	29,81	571
1031-22	7314150025503	5	30,46	571
1031-25	7314150025510	5	31,28	571
1031-28	7314150025527	5	32,23	571
1031-30	7314150025534	5	32,88	571
1031-32	7314150025541	5	33,57	571
1031-4	7314150025411	5	24,80	571
1031-40	7314150025558	5	35,99	571
1031-6	7314150025428	5	25,35	571
1031-8	7314150025435	5	25,88	571
1067	8412814010670	10	3,49	218
1084	7311518277291	5	87,04	270
10RM-10	7314153014351	1	19,79	45
10RM-13	7314153014368	1	22,45	45
10RM-14	7314150221677	1	22,82	45
10RM-17	7314153014375	1	26,54	45
10RM-19	7314153014382	1	29,10	45
10RM-8	7314153014344	1	17,59	45
10RM/SH6	7314150222971	1	143,69	46
10RZ-1/2	7314150358786	1	23,46	45
10RZ-11/16	7314150358816	1	29,12	45
10RZ-3/4	7314150358823	1	31,50	45
10RZ-3/8	7314150358762	1	20,93	45
10RZ-5/16	7314150358748	1	19,24	45
10RZ-5/8	7314150358809	1	27,70	45
10RZ-7/16	7314150358779	1	21,84	45
10RZ-9/16	7314150358793	1	24,67	45
111A	7314150476183	5	167,22	653
111M-10	7314151828653	10	7,26	40
111M-100	7314150401499	1	715,85	40
111M-11	7314151828660	10	7,89	40
111M-12	7314151828677	10	8,33	40
111M-13	7314151828684	10	8,77	40
111M-14	7314151828691	10	9,13	40
111M-15	7314151828707	10	9,46	40
111M-16	7314151828714	10	10,00	40
111M-17	7314151828721	10	10,69	40
111M-18	7314151828738	10	11,27	40
111M-19	7314151828745	10	12,88	40
111M-20	7314151828752	10	13,03	40
111M-21	7314151828769	10	14,89	40
111M-22	7314151828776	5	15,02	40
111M-23	7314151828783	5	15,90	40
111M-24	7314151828790	5	16,63	40
111M-25	7314151828806	5	18,04	40
111M-26	7314151828813	5	21,41	40
111M-27	7314151828820	5	23,55	40
111M-28	7314151828837	5	25,16	40
111M-29	7314151828844	5	25,79	40
111M-30	7314151828851	5	28,69	40
111M-32	7314151828868	5	30,92	40
111M-33	7314150222223	5	33,26	40
111M-34	7314151828875	5	35,79	40
111M-36	7314150135516	1	50,58	40
111M-38	7314150222230	1	59,82	40



111M-41	7314150135523	1	64,22	40
111M-46	7314150135530	1	84,69	40
111M-5.5	7314151828608	10	6,39	40
111M-50	7314150135547	1	95,92	40
111M-55	7314150135554	1	167,26	40
111M-6	7314151828615	10	5,81	40
111M-60	7314150135561	1	221,89	40
111M-65	7314150135578	1	295,49	40
111M-7	7314151828622	10	5,87	40
111M-70	7314150135585	1	351,24	40
111M-75	7314150135592	1	442,67	40
111M-8	7314151828639	10	6,04	40
111M-80	7314150135608	1	510,69	40
111M-85	7314150352999	1	687,01	40
111M-9	7314151828646	10	7,21	40
111M-90	7314150401475	1	695,25	40
111M-95	7314150401482	1	697,31	40
111M/11T	7314151828899	1	107,88	42
111M/14T	7314151828905	1	199,01	42
111M/17T	7314151828912	1	172,23	42
111M/17TL	7314150197859	1	221,71	42
111M/24T	7314150197866	1	364,21	42
111M/26T	7314151828929	1	380,62	42
111M/S10	7314150212965	1	94,61	42
111M/SH12	7314153013347	1	120,02	41
111M/SH5	7314150325252	1	45,64	41
111M/SH8	7314150197873	1	84,26	41
111Z-1	7314151829063	3	18,90	41
111Z-1.1/16	7314151829070	5	24,51	41
111Z-1.1/2	7314150135752	1	55,17	41
111Z-1.1/4	7314151829094	5	32,05	41
111Z-1.1/8	7314151829087	5	26,19	41
111Z-1.11/16	7314150135615	1	86,12	41
111Z-1.13/16	7314150135639	1	85,94	41
111Z-1.3/4	7314150135622	1	92,40	41
111Z-1.3/8	7314150135738	1	52,51	41
111Z-1.5/16	7314151829100	5	37,30	41
111Z-1.5/8	7314150135769	1	66,68	41
111Z-1.7/16	7314150135745	1	52,51	41
111Z-1.7/8	7314150135646	1	98,28	41
111Z-1/2	7314151828981	5	9,18	41
111Z-1/4	7314151828943	5	6,07	41
111Z-11/16	7314151829018	5	11,10	41
111Z-13/16	7314151829032	5	15,45	41
111Z-15/16	7314151829056	3	17,50	41
111Z-2	7314150135653	1	99,62	41
111Z-2.1/2	7314150135721	1	300,18	41
111Z-2.1/4	7314150135691	1	175,25	41
111Z-2.1/8	7314150135677	1	175,25	41
111Z-2.3/4	7314150135783	1	319,29	41
111Z-2.3/8	7314150135707	1	242,21	41
111Z-2.5/8	7314150135776	1	300,18	41
111Z-2.7/8	7314150135790	1	387,53	41
111Z-3	7314150135806	1	387,53	41
111Z-3/4	7314151829025	5	13,29	41
111Z-3/8	7314151828967	5	7,62	41
111Z-5/16	7314151828950	5	6,27	41
111Z-5/8	7314151829001	5	10,49	41
111Z-7/16	7314151828974	5	8,30	41
111Z-7/8	7314151829049	5	15,71	41
111Z-9/16	7314151828998	5	9,67	41
111Z/11T	7314151829124	1	153,78	43
111Z/8T	7314151829117	1	95,86	42
1150-1/2H/P	7314150129263	1	59,27	545
1150D	7311518276614	1	72,09	545
1154	7314150249831	1	141,47	326
1154-DG	7314150249800	1	77,10	326
1154-MB	7314150249817	1	57,17	326
1157	7311518277031	60	13,82	606
1162N-1/2	7314151847241	1	23,36	538
1177-SCRIBE	7314150120550	5	6,53	543
1178-SCRIBE	7314150120567	5	7,31	543
1179-FLX	7311518276997	25	2,71	543
1179-SCRIBE	7314150120574	5	21,44	543
1179-TIPS	7314150120581	1	7,43	543
11M-10	7314151829155	5	12,00	43
11M-11	7314151829162	5	12,00	43
11M-12	7314151829179	5	13,73	43
11M-13	7314151829186	5	13,73	43
11M-14	7314151829193	5	16,57	43
11M-15	7314151829209	5	16,57	43
11M-16	7314151829216	5	18,18	43
11M-17	7314151829223	5	18,76	43
11M-18	7314151829230	5	18,89	43
11M-19	7314151829247	5	23,75	43
11M-21	7314151829254	5	23,75	43
11M-22	7314151829261	5	17,81	43
11M-24	7314151829278	5	30,42	43
11M-27	7314151829285	1	39,45	43
11M-30	7314151829292	1	47,73	43
11M-32	7314151829308	1	47,73	43
11M-36	7314151829315	1	61,36	43
11M-38	7314151829322	1	65,02	43
11M-8	7314151829131	5	11,42	43
11M-9	7314151829148	5	11,42	43
11Z-1	7314150355303	5	37,41	43

			€	
11Z-1/2	7314150355235	5	12,15	43
11Z-11/16	7314150355266	5	15,05	43
11Z-13/16	7314150355280	5	17,66	43
11Z-3/4	7314150355273	5	16,85	43
11Z-3/8	7314150355211	5	11,41	43
11Z-5/8	7314150355259	5	15,05	43
11Z-7/16	7314150355228	5	11,80	43
11Z-9/16	7314150355242	5	12,58	43
121A	7314150476206	5	167,22	653
1300Z-1-1.1/8	7314153000989	1	69,67	52
1300Z-1/2-9/16	7314151039998	1	29,18	52
1300Z-1/4-5/16	7314153000965	1	26,56	52
1300Z-15/16-1	7314153005656	1	53,43	52
1300Z-19/32-11/16	7314151040000	1	33,64	52
1300Z-25/32-13/16	7314153000972	1	49,52	52
1300Z-3/8-7/16	7314151039981	1	26,56	52
1300Z-5/8-3/4	7314151040017	1	35,83	52
1300Z-7/8-15/16	7314153005649	1	41,01	52
1320RM-10-11	7314153014511	1	33,39	47
1320RM-12-13	7314153014528	1	35,61	47
1320RM-14-15	7314153014535	1	39,41	47
1320RM-16-17	7314153014542	1	43,26	47
1320RM-17-19	7314150359196	1	44,58	47
1320RM-18-19	7314153014559	1	46,55	47
1320RM-22-24	7314150221646	1	49,05	47
1320RM-6-7	7314153014498	1	31,05	47
1320RM-8-9	7314153014504	1	31,48	47
1320RM/SH8	7314150222988	1	317,35	47
1320RZ-1/2-9/16	7314153014580	1	45,27	47
1320RZ-1/4-5/16	7314153014566	1	31,05	47
1320RZ-3/4-13/16	7314150359264	1	40,60	47
1320RZ-3/4-7/8	7314150359271	1	40,60	47
1320RZ-3/8-7/16	7314153014573	1	39,57	47
1320RZ-5/16-11/32	7314153015235	60	33,69	47
1320RZ-5/8-11/16	7314150359257	1	26,11	47
1320RZ-7/8-15/16	7314150359288	1	53,73	47
1320SRM-14-19	7314150190355	1	41,94	47
1320SRM/S29	7314150188673	1	130,09	47
1321RZ-1/2-9/16	7314150359349	1	28,59	47
1321RZ-3/4-7/8	7314150359363	1	46,80	47
1321RZ-3/8-7/16	7314150359332	1	25,37	47
1321RZ-5/8-11/16	7314150359356	1	33,10	47
133SGM-100	7314151828523	1	552,66	55
133SGM-105	7314151828530	1	617,31	55
133SGM-110	7314151828547	1	673,88	55
133SGM-115	7314151828554	1	788,62	55
133SGM-120	7314151828561	1	801,55	55
133SGM-27	7314151828363	1	28,92	55
133SGM-30	7314151828370	1	33,95	55
133SGM-32	7314151828387	1	36,01	55
133SGM-36	7314151828394	1	46,40	55
133SGM-41	7314151828400	1	56,88	55
133SGM-46	7314151828417	1	76,60	55
133SGM-50	7314151828424	1	87,27	55
133SGM-55	7314151828431	1	101,79	55
133SGM-60	7314151828448	1	113,12	55
133SGM-65	7314151828455	1	141,75	55
133SGM-70	7314151828462	1	182,61	55
133SGM-75	7314151828479	1	195,53	55
133SGM-80	7314151828486	1	255,35	55
133SGM-85	7314151828493	1	268,27	55
133SGM-90	7314151828509	1	342,57	55
133SGM-95	7314151828516	1	360,37	55
14-24-3810	7311518002879	5	21,28	634
140	7314150008797	1	54,84	266
141	7314150008827	1	61,68	266
1410	7314150106332	1	77,09	266
1410D	7314150452842	1	85,88	266
1418-4	7314150510863	1	11,63	370
1418-5	7314150510870	1	13,77	370
1418-6	7314150510887	1	15,47	370
1418-7.5	7314150510894	1	17,61	370
1418-8.5	7314150510900	1	20,50	370
1418S	7314151040604	1	173,79	369
1419-M12	7314150257423	1	36,06	369
1419-M16	7314150358045	1	45,78	369
1419-M5	7314150257409	1	28,56	369
1419-M8	7314150257416	1	31,96	369
1419-MD	7311518277352	1	11,98	342
1419/4	7314150125036	1	129,93	369
142	7314150008841	1	82,96	266
1420	7314150103744	1	103,72	266
1420-1.4	7314151696337	1	3,37	369
1420D	7314150452859	1	115,50	266
1421-2.1	7314151696412	1	3,98	369
1422-3.1	7314151696689	1	5,55	369
1423-4.8	7314151696764	1	6,82	369
1424-6.2	7314151696849	1	8,17	369
143	7314150008872	1	135,48	266
1430FT120	7314150342006	1	127,48	384
1435/5	7314151040734	1	28,31	369
1435/8	7314151040741	1	89,45	369
144	7314150008902	1	225,71	266
1446	7314150128631	15	7,15	584
1446-CS	7314150508266	15	7,50	584
1446-FLOAT	7314150438464	15	12,32	584

			€	
1446-FLOAT-B	7314150524310	12	6,49	585
1446-OV	7314150313679	15	11,84	585
1450D-ISO	7314151040970	1	91,34	372
1450D-WVV	7314151040987	1	91,34	372
1450D/2	7314151040963	1	174,57	372
1460M/1	7314151041090	1	2.544,27	371
1460M/2	7314151041106	1	4.340,42	371
1460Z/2	7314151041120	1	6.453,23	372
1467-250	7314150124268	1	61,59	263
1467-320-850	7314150178636	1	258,79	263
1467-520	7314150124275	1	199,94	263
1467-LJ	7314150209033	1	19,17	264
1467-SJ	7314150208982	1	15,56	264
1468-10M10	7314150243457	1	19,65	349
1468-10M4	7314150243419	1	19,65	349
1468-10M5	7314150243426	1	19,65	349
1468-10M6	7314150243433	1	19,65	349
1468-10M8	7314150243440	1	19,65	349
1468-6M3	7314150243372	1	5,02	349
1468-6M4	7314150243389	1	5,02	349
1468-6M5	7314150243396	1	5,02	349
1468-6M6	7314150243402	1	5,02	349
1468-M10	7314150243228	6	256,78	348
1468-M6	7314150243211	1	102,22	348
147	7314150008933	1	434,96	266
147-1	7314150367047	1	40,09	117
147-1.1/4	7314150367061	1	42,60	117
147-1.1/8	7314150367054	1	40,09	117
147-1/2	7314150366965	1	35,08	117
147-11/16	7314150366996	1	35,08	117
147-13/16	7314150366644	1	31,33	117
147-13/16	7314150367016	1	40,09	117
147-14	7314150366651	1	31,33	117
147-15	7314150366668	1	31,33	117
147-15/16	7314150367030	1	40,09	117
147-16	7314150366675	1	31,33	117
147-17	7314150366682	1	31,33	117
147-18	7314150366699	1	31,33	117
147-19	7314150366705	1	31,33	117
147-21	7314150366712	1	37,58	117
147-22	7314150366729	1	37,58	117
147-24	7314150366736	1	37,58	117
147-25	7314150366743	1	42,60	117
147-27	7314150366750	1	42,60	117
147-3/4	7314150367009	1	35,08	117
147-30	7314150366767	1	42,60	117
147-32	7314150366774	1	42,60	117
147-33	7314150366781	1	46,37	117
147-34	7314150366798	1	46,37	117
147-35	7314150366804	1	46,37	117
147-36	7314150366811	1	46,37	117
147-37	7314150366828	1	48,87	117
147-38	7314150366835	1	48,87	117
147-39	7314150366842	1	48,87	117
147-41	7314150366859	1	48,87	117
147-45	7314150366866	1	172,91	117
147-46	7314150366873	1	172,91	117
147-5/8	7314150366989	1	35,08	117
147-50	7314150366880	1	179,17	117
147-55	7314150366897	1	192,95	117
147-60	7314150366903	1	206,73	117
147-65	7314150537860	1	211,15	117
147-68	7314150366910	1	233,04	117
147-7/16	7314150366958	1	35,08	117
147-7/8	7314150367023	1	40,09	117
147-70	7314150366927	1	233,04	117
147-75	7314150366934	1	273,13	117
147-9/16	7314150366972	1	35,08	117
147-90	7314150366941	1	345,81	117
1470K-AC1	7314150226498	1	102,72	382
1470K-AC2	7314150226504	1	121,98	382
1470K-AC3	7314150226511	1	44,94	382
1470K-AC4	7314150226528	1	51,36	382
1470K-AC7	7314150271320	1	129,58	383
1470K-AC8	7314150328581	1	103,83	383
1470K-AC8GR	7314150328598	1	103,83	383
1470K-ACSIDE	7314150226535	1	83,46	383
1470K-ACTD	7314150297269	1	197,45	382
1470K-ACTSS	7314150297283	1	385,18	382
1470K-ACTW	7314150297276	1	239,17	382
1470K7LH	7314150360444	1	781,13	381
1470K7LHBLUE	7314150407491	1	781,13	381
1470K7LHGREY	7314150407767	1	781,13	381
1470K7LHRED	7314150407507	1	781,13	381
1470KC2	7314150226696	1	181,63	383
1470KC3A	7314150506354	1	198,04	383
1470KC5	7314150226665	1	605,37	383
1470KC5PC	7314150226672	1	605,37	383
1470KCTRAY	7314150226702	1	45,15	383
1470KXL-ACTD	7314150297290	1	252,99	382
1470KXL-ACTSS	7314150297313	1	462,21	382
1470KXL-ACTW	7314150297306	1	377,63	382
1470KXLC-TRAY	7314150285549	1	67,89	383
1471KXLL2BKTTSS	7314150365432	1	2.732,67	380
1472K-ACTD	7314150399345	1	247,88	380
1472K-ACTSS	7314150399338	1	330,50	380



1472K-ACTW



€



1472K-ACTW	7314150393152	1	305,72	380
1472K5	7314150349463	1	898,16	377
1472K5BLACK	7314150349500	1	898,16	377
1472K5BLUE	7314150349616	1	898,16	377
1472K5GREY	7314150403813	1	898,16	377
1472K5RED	7314150349562	1	898,16	377
1472K5WHITE	7314150403707	1	898,16	377
1472K6	7314150349470	1	935,84	377
1472K6BLACK	7314150349531	1	935,84	377
1472K6BLUE	7314150349623	1	935,84	377
1472K6GREY	7314150403820	1	935,84	377
1472K6RED	7314150349579	1	935,84	377
1472K6WHITE	7314150399888	1	935,84	377
1472K7	7314150349487	1	972,99	377
1472K7BLACK	7314150349548	1	972,99	377
1472K7BLUE	7314150349630	1	972,99	377
1472K7GREY	7314150403837	1	972,99	377
1472K7RED	7314150349586	1	972,99	377
1472K7WHITE	7314150403714	1	972,99	377
1472K8	7314150349494	1	1.010,16	376
1472K8BLACK	7314150349555	1	1.010,16	376
1472K8BLUE	7314150349647	1	1.010,16	376
1472K8GREY	7314150404018	1	1.010,16	376
1472K8RED	7314150349593	1	1.010,16	376
1472K8WHITE	7314150403721	1	1.010,16	376
1475K-ACSIDE	7314150419968	1	63,02	383
1475K6	7314150349654	1	1.019,99	381
1475K6BLACK	7314150349685	1	1.019,99	381
1475K6BLUE	7314150349760	1	1.019,99	381
1475K6RED	7314150349715	1	1.019,99	381
1475K7	7314150349661	1	1.055,04	381
1475K7BLACK	7314150349692	1	1.055,04	381
1475K7BLUE	7314150349814	1	1.055,04	381
1475K7RED	7314150349746	1	1.055,04	381
1475K8	7314150349678	1	1.096,50	381
1475K8BLACK	7314150349708	1	1.096,50	381
1475K8BLUE	7314150349821	1	1.096,50	381
1475K8RED	7314150349753	1	1.096,50	381
1475KXL-AC20BK	7314150353903	1	473,84	382
1475KXL12	7314150350223	1	1.652,81	380
1475KXL12BLACK	7314150350230	1	1.652,81	380
1475KXL12RED	7314150402731	1	1.652,81	380
1475KXL6	7314150349968	1	1.500,89	381
1475KXL6BLACK	7314150349999	1	1.500,89	381
1475KXL6BLUE	7314150350162	1	1.500,89	381
1475KXL6C	7314150350193	1	1.610,18	381
1475KXL6CBK-FF5	7314150437467	1	3.676,50	376
1475KXL6CBK-FF6	7314150437474	1	2.926,87	375
1475KXL6CBLACK	7314150350209	1	1.610,18	381
1475KXL6RED	7314150350124	1	1.500,89	381
1475KXL7	7314150349975	1	1.555,53	380
1475KXL7BLACK	7314150350070	1	1.555,53	380
1475KXL7BLUE	7314150350179	1	1.555,53	380
1475KXL7RED	7314150350148	1	1.555,53	380
1475KXL8	7314150349982	1	1.599,25	380
1475KXL8BLACK	7314150350094	1	1.599,25	380
1475KXL8BLUE	7314150350186	1	1.599,25	380
1475KXL8RED	7314150350155	1	1.599,25	380
1475KXXL-ACTSS	7314150459896	1	392,53	381
1475KXXL-ACTW	7314150465330	1	710,80	382
1475KXXL8CWTSS	7314150400157	1	4.662,48	380
1476KXXL7BK	7314150439935	1	2.864,43	380
1477K-AC10	7314150351633	1	92,90	379
1477K-AC12	7314150369195	1	177,05	377
1477K-AC13	7314150369218	1	118,04	377
1477K-AC14	7314150369225	1	53,12	378
1477K-AC15	7314150369249	1	141,64	378
1477K-AC16	7314150369256	1	236,07	378
1477K-AC17	7314150369270	1	47,21	378
1477K-AC18	7314150369287	1	54,30	378
1477K-AC19	7314150369676	1	47,21	378
1477K-AC20	7314150369683	1	42,49	378
1477K-AC21	7314150370412	1	88,53	378
1477K-AC22	7314150369706	1	65,21	378
1477K-AC24	7314150370429	1	324,60	379
1477K-AC25	7314150370436	1	413,14	379
1477K-AC26	7314150414864	1	81,35	379
1477K-AC30	7314150469949	1	123,74	379
1477K-ACTD	7314150370474	1	201,20	379
1477K-ACTP	7314150383764	1	102,70	379
1477K-ACTSS	7314150370450	1	283,29	379
1477K-ACTW	7314150370467	1	247,88	379
1477K6	7314150350391	1	1.326,02	376
1477K6BLACK	7314150351091	1	1.326,02	376
1477K6GREY	7314150351138	1	1.326,02	376
1477K6RED	7314150403653	1	1.326,02	376
1477K6WHITE	7314150358137	1	1.326,02	376
1477K7	7314150350407	1	1.391,59	376
1477K7BLACK	7314150351107	1	1.391,59	376
1477K7GREY	7314150351145	1	1.391,59	376
1477K7RED	7314150403660	1	1.391,59	376
1477K7WHITE	7314150358144	1	1.391,59	376
1477K8	7314150350414	1	1.424,39	376
1477K8BLACK	7314150351114	1	1.424,39	376
1477K8GREY	7314150351183	1	1.424,39	376
1477K8RED	7314150403677	1	1.424,39	376



€



1477K8WHITE	7314150358151	1	1.424,39	376
1477K9	7314150350940	1	1.468,09	376
1477K9BLACK	7314150351121	1	1.468,09	376
1477K9GREY	7314150351190	1	1.468,09	376
1477K9RED	7314150403684	1	1.468,09	376
1477K9WHITE	7314150403691	1	1.468,09	376
148-1	7314150367801	1	42,60	118
148-1/2	7314150367726	1	35,08	118
148-11/16	7314150367757	1	35,08	118
148-13	7314150367559	1	32,57	118
148-13/16	7314150367771	1	42,60	118
148-14	7314150367566	1	32,57	118
148-15	7314150367573	1	32,57	118
148-15/16	7314150367795	1	42,60	118
148-16	7314150367580	1	32,57	118
148-17	7314150367597	1	32,57	118
148-18	7314150367603	1	32,57	118
148-19	7314150367610	1	32,57	118
148-21	7314150367627	1	37,58	118
148-22	7314150367634	1	37,58	118
148-24	7314150367641	1	37,58	118
148-27	7314150367658	1	37,58	118
148-28	7314150367665	1	42,60	118
148-3/4	7314150367764	1	35,08	118
148-30	7314150367672	1	42,60	118
148-32	7314150367689	1	42,60	118
148-34	7314150367696	1	46,37	118
148-36	7314150367702	1	46,37	118
148-41	7314150367719	1	46,37	118
148-5/8	7314150367740	1	35,08	118
148-7/8	7314150367788	1	42,60	118
148-9/16	7314150367733	1	35,08	118
1482K4	7314150415779	1	572,89	377
1482K4BKW	7314150426126	1	716,11	377
1482K4BLACK	7314150415786	1	572,89	377
1482K4BLUE	7314150415793	1	572,89	377
1482K4GREY	7314150415809	1	572,89	377
1482K4RED	7314150415816	1	572,89	377
1482K4W	7314150425174	1	716,11	377
1482K4WHITE	7314150415823	1	572,89	377
1482K5W	7314150431274	1	802,04	377
1483CART	7314150273256	1	209,80	458
1483K2RB	7314150230013	1	330,61	458
1483K3RB	7314150230037	1	401,93	458
1483KHD3RB	7314150230099	1	544,54	458
1483KHD3RB-FF1	7314150233564	1	2.765,44	456
1483KHD3RB-FF2	7314150233571	1	2.695,75	456
1483KHD3RB-FF3	7314150233588	1	2.639,30	457
1483KHD3RB-FF4	7314150233595	1	2.194,40	457
1483KHD3RB-FF5	7314150233601	1	2.637,69	457
1483KHD3RB-FF7	7314150336050	1	2.005,10	457
1483KHD4RB	7314150230105	1	641,78	458
1484THD3RB	7314150265435	1	483,90	458
1485K4	7314150349838	1	631,50	381
1485K4BLACK	7314150349920	1	631,50	381
1485K4BLUE	7314150349944	1	631,50	381
1485K4RED	7314150349937	1	631,50	381
1485KXL4	7314150350247	1	820,36	381
1485KXL4BLACK	7314150350346	1	820,36	381
1485KXL4BLUE	7314150350360	1	820,36	381
1485KXL4RED	7314150350353	1	820,36	381
1487K4	7314150351206	1	1.003,31	376
1487K4BKW	7314150426133	1	1.003,31	376
1487K4BLACK	7314150351213	1	1.003,31	376
1487K4GREY	7314150351237	1	1.003,31	376
1487K4W	7314150425181	1	1.025,47	376
1495CD-AC1	7314150296965	1	80,27	453
1495CD60	7314150296927	1	508,35	450
1495CD60TS1	7314150325627	1	1.961,83	448
1495CD60W	7314150303656	1	1.056,83	451
1495CS-AC1	7314150296910	1	120,40	453
1495CS15	7314150296934	1	688,95	450
1495CS15BL	7314150326860	1	688,95	450
1495CS15TS1	7314150325610	1	2.111,19	448
1495CS18	7314150296941	1	769,21	450
1495CS18BL	7314150326891	1	769,21	450
1495CS18BLHK	7314150407620	1	838,11	450
1495CS18HK	7314150407613	1	838,11	450
1495CS18TS1	7314150325603	1	2.227,89	448
1495FWB097TD	7314150296675	1	529,53	456
1495FWB120TD	7314150296682	1	590,85	456
1495FWB120TS	7314150296668	1	406,90	456
1495K6CBKWB15TS	7314150368990	1	1.525,04	455
1495K6CBKWB15TW	7314150369034	1	1.765,84	455
1495K6CBKWB18TS	7314150369591	1	1.591,93	454
1495K6CBKWB18TW	7314150369638	1	1.899,62	455
1495K6CBLWB15TS	7314150369119	1	1.525,04	455
1495K6CBLWB15TW	7314150369232	1	1.765,84	455
1495K6CBLWB18TS	7314150369744	1	1.591,93	454
1495K6CBLWB18TW	7314150369782	1	1.899,62	455
1495K6CRDWB15TS	7314150368600	1	1.525,04	455
1495K6CRDWB15TW	7314150368655	1	1.765,84	455
1495K6CRDWB18TS	7314150369478	1	1.591,93	454
1495K6CRDWB18TW	7314150369515	1	1.899,62	455
1495K6CWB15TS	7314150368440	1	1.525,04	455
1495K6CWB15TW	7314150368501	1	1.765,84	455



168-26	7314150419432	1	112,30	121
168-27	7314150419449	1	112,30	121
168-3/4	7314150419524	1	73,02	121
168-3/8	7314150419463	1	58,64	121
168-5/16	7314150419456	1	58,64	121
168-5/8	7314150419500	1	62,11	121
168-6-3.2-1P	7311518152338	12	1,75	26
168-6-3.2-3P	7311518152413	12	5,04	27
168-6-3.5-1P	7311518152345	12	1,75	26
168-6-3.5-3P	7311518152420	12	5,04	27
168-7	7314150419241	1	55,11	120
168-7/16	7314150419470	1	58,64	121
168-7/8	7314150419548	1	98,77	121
168-8	7314150419258	1	55,11	120
168-8-4.0-1P	7311518152352	12	1,75	26
168-8-4.0-3P	7311518152437	12	5,04	27
168-8-4.0-6	7311518217419	6	1,71	27
168-8-4.5-1P	7311518152369	12	1,75	26
168-8-4.5-3P	7311518152444	12	5,04	27
168-8-4.5-6	7311518217426	6	1,71	27
168-8-4.8-1P	7311518152376	12	1,75	26
168-8-4.8-3P	7311518152451	12	5,04	27
168-8-4.8-6	7311518217433	6	1,71	27
168-8-5.2-1P	7311518152383	12	1,75	26
168-8-5.2-3P	7311518152468	12	5,04	27
168-8-5.2-6	7311518217440	6	1,72	27
168-8-5.5-1P	7311518152390	12	1,75	26
168-8-5.5-3P	7311518152475	12	5,04	27
168-8-5.5-6	7311518217457	6	1,71	27
168-8-6.3-1P	7311518152406	12	2,01	26
168-8-6.3-3P	7311518152482	12	5,04	27
168-9	7314150419265	1	55,11	120
168-9/16	7314150419494	1	60,55	121
168-COMBI-4.0	7311518209667	10	15,02	27
168-COMBI-4.0-6922	7311518209612	10	29,11	27
168-COMBI-4.5	7314150272860	10	15,02	27
168-COMBI-4.8	7311518209674	10	15,02	27
168-COMBI-4.8-6920	7311518209643	10	29,90	27
168-COMBI-5.5	7311518209681	10	15,02	27
168-COMBI-5.5-6924	7311518209650	10	29,90	27
169-10	7314150419630	1	57,89	121
169-11	7314150419647	1	57,89	121
169-12	7314150419654	1	59,88	121
169-13	7314150419661	1	59,88	121
169-14	7314150419678	1	59,88	121
169-15	7314150419715	1	59,88	121
169-16	7314150419722	1	61,25	121
169-17	7314150419739	1	61,25	121
169-18	7314150419746	1	66,06	121
169-19	7314150419753	1	68,40	121
169-20	7314150419760	1	72,00	121
169-21	7314150419777	1	77,99	121
169-22	7314150419784	1	97,56	121
169-23	7314150419791	1	97,56	121
169-24	7314150419807	1	97,56	121
169-27	7314150419814	1	117,82	121
169-7	7314150419609	1	57,89	121
169-8	7314150419616	1	57,89	121
169-9	7314150419623	1	57,89	121
16F-1/2	7314150418565	1	79,54	119
16F-1/4	7314150418541	1	79,54	119
16F-3/8	7314150418558	1	79,54	119
16R-1/2	7314150418602	1	101,01	119
16R-1/4	7314150418589	1	101,01	119
16R-3/8	7314150418596	1	101,01	119
1931M-10	7314151049256	5	11,33	49
1931M-11	7314151049263	5	12,17	49
1931M-12	7314151049270	5	12,17	49
1931M-13	7314151049287	5	12,17	49
1931M-14	7314151049294	5	12,99	49
1931M-17	7314151049324	5	17,19	49
1931M-4	7314151049171	5	9,65	49
1931M-4.5	7314151049188	5	9,65	49
1931M-5	7314151049195	5	9,65	49
1931M-5.5	7314151049201	5	9,65	49
1931M-6	7314151049218	5	9,65	49
1931M-7	7314151049225	5	9,65	49
1931M-8	7314151049232	5	10,06	49
1931M-9	7314151049249	5	10,90	49
1931M/10T	7314151049409	1	108,60	50
1931Z-1/2	7314151049775	5	12,99	49
1931Z-1/4	7314151049713	5	10,06	49
1931Z-1/8	7314150371563	5	15,52	49
1931Z-11/32	7314151049744	5	11,75	49
1931Z-11/32-3/8	7314150371624	5	18,45	49
1931Z-13/64	7314151049683	5	10,06	49
1931Z-15/64-1/4	7314150371570	5	17,35	49
1931Z-3/16	7314151049676	5	10,06	49
1931Z-3/8	7314151049751	5	12,17	49
1931Z-5/16	7314151049737	5	11,33	49
1931Z-5/32	7314151049669	5	10,06	49
1931Z-5/8	7314151049799	5	15,92	49
1931Z-7/16	7314151049768	5	12,99	49
1931Z-7/32	7314151049690	5	10,06	49
1931Z-9/16	7314151049782	5	13,85	49
1931Z-9/32	7314151049720	5	10,48	49



1931Z-9/32-5/16	7314150371600	5	16,37	49
1931Z/12T	7314150107674	1	140,40	50
1933M/6T	7314151821654	1	58,57	50
1936M-10-11	7314151051402	25	8,16	58
1936M-10-13	7314151344146	25	8,91	58
1936M-12-13	7314151051419	25	8,91	58
1936M-13-17	7314151830144	20	10,37	58
1936M-14-15	7314151051426	20	9,41	58
1936M-14-17	7314151051129	15	10,21	58
1936M-16-17	7314151051433	15	10,21	58
1936M-17-19	7314151051136	10	12,18	58
1936M-18-19	7314151051440	10	12,18	58
1936M-19-22	7314151051150	8	13,42	58
1936M-20-22	7314151830151	8	13,55	58
1936M-21-23	7314151830168	8	15,52	58
1936M-22-24	7314151830175	5	16,41	58
1936M-24-26	7314151830182	5	17,26	58
1936M-24-27	7314151051181	5	17,26	58
1936M-25-28	7314151830199	5	19,02	58
1936M-30-32	7314151051501	1	22,35	58
1936M-30-34	7314151838577	4	34,37	58
1936M-36-41	7314151830205	4	34,63	58
1936M-46-50	7314151830212	2	68,96	58
1936M-6-7	7314151051389	50	6,01	58
1936M-8-10	7314151830137	30	8,16	58
1936M-8-9	7314151051396	5	6,96	58
1936M/12	7314151830250	1	185,35	58
1936M/7	7314151830243	1	105,29	58
1943M-11-13	7314151052829	1	27,99	53
1943M-13-15	7314151804732	1	29,82	53
1943M-13-17	7314151804749	1	31,48	53
1943M-14-17	7314151052843	1	32,09	53
1943M-15-17	7314151052850	1	32,41	53
1943M-19-22	7314151052867	1	34,34	53
1943Z-11/16-13/16	7314150355174	1	35,92	53
1943Z-5/16-3/8	7314150355136	1	30,52	53
1943Z-5/8-3/4	7314150355167	1	32,00	53
1943Z-7/16-1/2	7314150355143	1	30,52	53
1943Z-9/16-5/8	7314150355150	1	32,00	53
1945W12	7314150352289	6	56,41	316
1945W14	7314150352265	8	36,88	316
1945W38	7314150352272	6	44,47	316
1949M-10-11	7314151055394	1	23,21	54
1949M-10-12	7314151055400	1	24,09	54
1949M-12-13	7314151055417	1	24,81	54
1949M-12-14	7314151055424	1	26,03	54
1949M-14-15	7314151304546	1	26,03	54
1949M-14-17	7314151055448	1	26,03	54
1949M-17-19	7314151055455	1	35,57	54
1949M-19-22	7314151055462	1	35,57	54
1949M-22-24	7314151304553	1	40,71	54
1949M-24-27	7314151055479	1	51,46	54
1949M-30-32	7314151304577	1	63,70	54
1949M-8-9	7314151304539	1	23,21	54
1949Z-1-1.1/8	7314151055547	1	56,66	54
1949Z-1/2-9/16	7314151055509	1	28,08	54
1949Z-3/4-7/8	7314151055530	1	33,95	54
1949Z-3/8-7/16	7314151055486	1	25,01	54
1949Z-5/8-3/4	7314151055523	1	31,46	54
1950MZ-3/8	7314150130207	1	77,02	55
1952M-10	7314151057213	10	10,20	43
1952M-11	7314151057220	10	10,94	43
1952M-12	7314151057237	10	11,56	43
1952M-13	7314151057244	10	12,53	43
1952M-14	7314151057251	10	12,64	43
1952M-15	7314151057268	10	14,96	43
1952M-16	7314151057275	10	16,18	43
1952M-17	7314151057282	10	16,72	43
1952M-18	7314151057299	10	18,71	43
1952M-19	7314151057305	10	19,61	43
1952M-20	7314151057312	10	20,77	43
1952M-21	7314151057329	10	21,58	43
1952M-22	7314151057336	5	24,20	43
1952M-23	7314151057343	5	26,14	43
1952M-24	7314151057350	5	27,32	43
1952M-25	7314151057367	5	29,16	43
1952M-26	7314151057374	5	29,44	43
1952M-27	7314151057381	5	31,39	43
1952M-28	7314151057398	1	35,79	43
1952M-29	7314151325763	1	38,20	43
1952M-30	7314151057404	1	40,11	43
1952M-32	7314151057411	1	41,94	43
1952M-34	7314151838553	1	54,36	43
1952M-36	7314151057428	1	71,26	43
1952M-41	7314151057435	1	88,59	43
1952M-46	7314151840105	1	142,53	43
1952M-50	7314151840112	1	181,18	43
1952M-55	7314151840129	1	231,37	43
1952M-6	7314151057176	10	9,18	43
1952M-60	7314151840136	1	352,35	43
1952M-65	7314150135226	1	450,30	43
1952M-7	7314151057183	10	9,18	43
1952M-70	7314150135301	1	486,21	43
1952M-75	7314150135325	1	550,97	43
1952M-8	7314151057190	10	9,07	43
1952M-80	7314150135509	1	660,59	43

		€			
1952M-9	7314151057206	10	10,20	43	
1952M/10	7314151057688	1	128,45	44	
1952M/14T	7314151057695	1	286,77	44	
1952M/17T	7314151057473	1	258,69	44	
1952M/26T	7314151057701	1	557,38	44	
1952M/7T	7314151806637	1	109,13	44	
1952M/SH12	7314153013330	1	176,72	44	
1952M/SH6	7314153013286	1	79,43	44	
1952Z-1	7314151057602	1	30,20	43	
1952Z-1.1/16	7314151057619	1	33,20	43	
1952Z-1.1/2	7314151057756	1	94,54	43	
1952Z-1.1/4	7314151057633	1	45,02	43	
1952Z-1.1/8	7314151057626	1	39,20	43	
1952Z-1.3/8	7314151057732	1	88,28	43	
1952Z-1.5/16	7314151057718	1	48,61	43	
1952Z-1.5/8	7314151057763	1	113,32	43	
1952Z-1.7/16	7314151057749	1	93,60	43	
1952Z-1/2	7314151057527	5	19,46	43	
1952Z-1/4	7314151057480	5	9,68	43	
1952Z-11/16	7314151057558	5	19,42	43	
1952Z-11/32	7314150111046	5	10,45	43	
1952Z-13/16	7314151057572	5	22,71	43	
1952Z-15/16	7314151057596	5	29,03	43	
1952Z-3/4	7314151057565	5	21,23	43	
1952Z-3/8	7314151057503	5	10,98	43	
1952Z-5/16	7314151057497	5	9,83	43	
1952Z-5/8	7314151057541	5	16,48	43	
1952Z-7/16	7314151057510	5	11,92	43	
1952Z-7/8	7314151057589	5	27,25	43	
1952Z-9/16	7314151057534	5	14,51	43	
1952Z/11T	7314151057725	1	179,90	45	
1976TORX-T10	7314150123438	5	7,71	228	
1976TORX-T15	7314150123452	5	7,93	228	
1976TORX-T20	7314150123469	5	8,02	228	
1976TORX-T25	7314150123476	5	8,13	228	
1976TORX-T27	7314150123490	5	9,01	228	
1976TORX-T30	7314150123506	5	9,45	228	
1976TORX-T40	7314150123513	5	10,09	228	
1976TORX-T6	7314150122240	5	7,62	228	
1976TORX-T7	7314150123384	5	7,62	228	
1976TORX-T8	7314150123391	5	7,62	228	
1976TORX-T9	7314150123414	5	7,39	228	
1976TORX/5T	7314150126927	1	41,22	228	
1986TORX-T10	7314150123537	5	8,74	228	
1986TORX-T15	7314150123544	5	8,96	228	
1986TORX-T20	7314150123551	5	9,08	228	
1986TORX-T25	7314150123568	5	9,24	228	
1986TORX-T27	7314150123575	5	9,31	228	
1986TORX-T30	7314150123582	5	9,69	228	
1986TORX-T40	7314150123599	5	10,34	228	
1986TORX-T9	7314150122233	5	8,44	228	
1986TORX/7T	7314150123735	1	68,80	228	
1995LM-1.5	7314150122172	10	0,70	224	
1995LM-10	7314150123254	10	4,86	224	
1995LM-12	7314150123261	10	7,29	224	
1995LM-14	7314150123278	10	9,00	224	
1995LM-2	7314150122189	10	0,51	224	
1995LM-2.5	7314150123162	10	0,61	224	
1995LM-3	7314150123179	10	0,80	224	
1995LM-4	7314150123186	10	0,92	224	
1995LM-5	7314150123209	10	1,35	224	
1995LM-6	7314150123216	10	2,02	224	
1995LM-7	7314150123223	10	2,66	224	
1995LM-8	7314150123230	10	3,46	224	
1995LM-9	7314150123247	10	4,32	224	
1995M-0.9	7314150216291	10	0,80	223	
1995M-1.5	7314150122158	10	0,50	223	
1995M-10	7314150122912	10	2,37	223	
1995M-12	7314150122943	10	3,83	223	
1995M-14	7314150122967	10	5,40	223	
1995M-17	7314150122974	10	8,66	223	
1995M-19	7314150122981	10	13,05	223	
1995M-2	7314150122745	10	0,55	223	
1995M-2.5	7314150122752	10	0,57	223	
1995M-22	7314150122998	10	19,45	223	
1995M-3	7314150122769	10	0,76	223	
1995M-4	7314150122776	10	0,86	223	
1995M-5	7314150122790	10	0,82	223	
1995M-6	7314150122813	10	1,03	223	
1995M-7	7314150122837	10	1,47	223	
1995M-8	7314150122851	10	1,84	223	
1995M-9	7314150122875	10	2,12	223	
1995M/10T	7314150123643	1	16,71	223	
1995M/11T	7314150123650	1	20,55	223	
1995M/15T	7314150123667	1	70,42	223	
1995M/6T	7314150123629	1	5,59	223	
1995M/8T	7314150123636	1	10,34	223	
1995TORX-T10	7314150123308	5	5,07	226	
1995TORX-T15	7314150123322	5	5,17	226	
1995TORX-T20	7314150123339	5	5,38	226	
1995TORX-T25	7314150123346	5	5,40	226	
1995TORX-T27	7314150123353	5	5,52	226	
1995TORX-T30	7314150123360	5	5,61	226	
1995TORX-T40	7314150123377	5	5,88	226	
1995TORX-T45	7314150123407	5	6,13	226	
1995TORX-T50	7314150123421	5	6,96	226	

		€			
1995TORX-T55	7314150216963	5	9,89	226	
1995TORX-T6	7314150122196	5	6,26	226	
1995TORX-T60	7314150216970	5	12,00	226	
1995TORX-T7	7314150123285	5	6,26	226	
1995TORX-T8	7314150123292	5	6,26	226	
1995TORX-T9	7314150122219	5	5,93	226	
1995TORX/11T	7314150123742	1	67,32	226	
1995TORX/13T	7314150123759	1	80,83	227	
1995TORX/4T	7314150123674	1	24,64	226	
1995TORX/7T	7314150123711	1	40,18	226	
1995Z-1/16	7314150122165	10	0,54	223	
1995Z-1/2	7314150123117	10	5,42	223	
1995Z-1/4	7314150123070	10	1,19	223	
1995Z-1/8	7314150123025	10	0,60	223	
1995Z-3/16	7314150123056	10	0,84	223	
1995Z-3/32	7314150123018	10	0,47	223	
1995Z-3/4	7314150123155	10	16,52	223	
1995Z-3/8	7314150123094	10	2,89	223	
1995Z-5/16	7314150123087	10	2,00	223	
1995Z-5/32	7314150123049	10	0,74	223	
1995Z-5/64	7314150123001	10	0,44	223	
1995Z-5/8	7314150123131	10	9,79	223	
1995Z-7/16	7314150123100	10	4,43	223	
1995Z-7/32	7314150123063	10	0,97	223	
1995Z/10T	7314150215980	1	13,79	224	
1995Z/12T	7314150215997	1	22,45	224	
1996M-1.5	7314150122202	10	1,62	225	
1996M-10	7314150122721	10	9,39	225	
1996M-12	7314150122738	5	10,04	225	
1996M-2	7314150122653	10	1,80	225	
1996M-2.5	7314150122660	10	1,63	225	
1996M-3	7314150122677	10	1,68	225	
1996M-4	7314150122684	10	2,00	225	
1996M-5	7314150122691	10	3,27	225	
1996M-6	7314150122707	10	3,72	225	
1996M-8	7314150122714	10	5,24	225	
1996TORX-T10	7314150122783	5	8,88	227	
1996TORX-T15	7314150122806	5	9,17	227	
1996TORX-T20	7314150122820	5	9,31	227	
1996TORX-T25	7314150122844	5	9,46	227	
1996TORX-T27	7314150122868	5	9,52	227	
1996TORX-T30	7314150122882	5	9,97	227	
1996TORX-T40	7314150122899	5	10,63	227	
1996TORX-T45	7314150122905	5	11,14	227	
1996TORX-T50	7314150122929	5	12,62	227	
1996TORX-T9	7314150122226	5	7,70	227	
1996TORX/5T	7314150123698	1	46,89	227	
1998M-1.5	7314150185719	10	0,60	222	
1998M-10	7314150185801	10	2,94	222	
1998M-12	7314150185818	5	4,32	222	
1998M-14	7314150185825	1	5,84	222	
1998M-17	7314150185832	1	9,24	222	
1998M-19	7314150185849	1	13,86	222	
1998M-2	7314150185726	10	0,62	222	
1998M-2.5	7314150185733	10	0,66	222	
1998M-22	7314150185856	1	20,55	222	
1998M-3	7314150185740	10	0,86	222	
1998M-4	7314150185757	10	0,77	222	
1998M-5	7314150185764	10	1,07	222	
1998M-6	7314150185863	10	1,31	222	
1998M-7	7314150185771	10	1,84	222	
1998M-8	7314150185788	10	2,11	222	
1998M-9	7314150185795	5	2,82	222	
1998M/10T	7314150186228	1	17,89	222	
1998M/11T	7314150186235	1	23,18	222	
1998M/15T	7314150186242	1	75,84	222	
1998M/6T	7314150186204	1	7,29	222	
1998M/8R	7314150186266	1	12,72	222	
1998M/8T	7314150186211	1	11,72	222	
1999M/7H	7314151801076	1	32,77	222	
1999MV-10	7314150121496	3	19,97	502	
1999MV-12	7314150121502	3	22,45	502	
1999MV-3	7314150121427	5	15,40	502	
1999MV-4	7314150121434	5	15,95	502	
1999MV-5	7314150121441	5	15,79	502	
1999MV-6	7314150121458	5	16,10	502	
1999MV-7	7314150121465	5	16,86	502	
1999MV-8	7314150121472	5	17,81	502	
1999MV-9	7314150121489	5	18,42	502	
1RM-10	7314153000576	1	25,75	45	
1RM-11	7314153000583	1	27,33	45	
1RM-12	7314153000590	1	29,35	45	
1RM-13	7314153000606	1	30,40	45	
1RM-14	7314153000613	1	31,72	45	
1RM-15	7314153000620	1	32,61	45	
1RM-16	7314153000637	1	35,55	45	
1RM-17	7314153000644	1	35,86	45	
1RM-18	7314153000651	1	38,80	45	
1RM-19	7314153000668	1	39,13	45	
1RM-21	7314150214495	1	41,79	45	
1RM-22	73141530005915	1	42,15	45	
1RM-24	73141530005922	1	45,54	45	
1RM-27	7314153014177	1	53,16	45	
1RM-30	7314153014184	1	64,30	45	
1RM-32	7314153014191	1	69,96	4	

1RM-7



1RM-7	7314153014153	1	22,55	45
1RM-8	7314153000552	1	23,82	45
1RM-9	7314153000569	1	24,12	45
1RM/S5	7314150225514	10	155,22	46
1RM/SH12	7314150219780	10	387,58	46
1RM/SH6	7314150219773	1	183,46	46
1RM/SH8	7314150223015	1	262,55	46
1RMA-10-1/4-BIT	7314153014634	1	7,63	48
1RMA-10-1/4-SQ	7314153014603	1	9,72	48
1RMA-13-10-BIT	7314150223008	1	12,03	48
1RMA-13-3/8-SQ	7314153014610	1	10,22	48
1RMA-13-5/16-BIT	7314153014641	1	8,37	48
1RMA-19-1/2-SQ	7314153014627	1	11,05	48
1RMA-19-1/4-SQ	7314150190638	1	10,81	48
1RMA/S4	7314153014658	1	38,30	48
1RMA/S8	7314153014665	1	139,75	46
1RZ-1/2	7314153014245	1	33,28	45
1RZ-1/4	7314150153725	1	25,90	45
1RZ-11/16	7314153014269	1	40,71	45
1RZ-11/32	7314150358915	1	22,55	45
1RZ-15/16	7314150358939	1	58,50	45
1RZ-3/4	7314153014276	1	44,22	45
1RZ-3/8	7314153014214	1	27,08	45
1RZ-5/16	7314153014207	1	26,17	45
1RZ-5/8	7314153014252	1	38,27	45
1RZ-7/16	7314153014221	1	29,88	45
1RZ-7/8	7314150358922	1	48,63	45
1RZ-9/16	7314153014238	1	34,58	45
1RZ/SH8	7314150223022	1	282,95	46
1Z-1	7314150375189	10	16,83	41
1Z-1/2	7314150375103	10	6,30	41
1Z-11/16	7314150375134	10	7,81	41
1Z-11/32	7314150375073	10	5,33	41
1Z-13/16	7314150375158	10	10,43	41
1Z-15/16	7314150375172	5	16,59	41
1Z-3/16	7314150375028	20	7,46	41
1Z-3/4	7314150375141	10	9,01	41
1Z-3/8	7314150375080	10	5,33	41
1Z-5/16	7314150375066	10	4,64	41
1Z-5/8	7314150375127	10	7,54	41
1Z-7/16	7314150375097	10	5,70	41
1Z-7/32	7314150375035	20	7,46	41
1Z-7/8	7314150375165	10	10,43	41
1Z-9/16	7314150375110	10	6,67	41
1Z-9/32	7314150375059	20	7,18	41
2-21-51	7315962500011	5	16,35	633
2-300-14-0-0	7311518044138	10	7,73	31
2-300-14-2-0	7311518044145	10	7,73	31
2-300-14-4-0	7311518108786	10	8,15	31
2-300-14-D-1P	7311518189105	10	53,89	34
2-300-16-0-0	7311518020491	10	8,39	31
2-300-16-1-0	7311518020507	10	8,39	31
2-300-16-2-0	7311518020514	10	8,39	31
2-300-16-4-0	7311518020521	10	8,90	31
2-300-16-D-1P	7311518189129	10	72,31	34
2-300-18-0-0	7311518190545	10	9,76	31
2-300-18-2-0	7311518190552	10	9,76	31
2-301-14-0-0	7311518190569	10	8,90	31
2-301-14-2-0	7311518108748	10	8,90	31
2-301-14-D-1P	7311518189136	1	53,89	34
2-301-16-0-0	7311518108755	10	9,76	31
2-301-16-1-0	7311518020538	10	9,76	31
2-301-16-2-0	7311518020545	10	9,76	31
2-302-14-0-0	7311518044152	10	8,90	32
2-302-14-2-0	7311518044169	10	8,90	32
2-302-14-4-0	7311518108793	10	9,28	32
2-302-14-D-1P	7311518189150	10	59,30	34
2-302-16-0-0	7311518108762	10	9,76	32
2-302-16-1-0	7311518020552	10	9,76	32
2-302-16-2-0	7311518020569	10	9,76	32
2-302-16-4-0	7311518108809	10	10,14	32
2-302-16-D-1P	7311518189167	10	79,30	34
2-302-18-0-0	7311518190613	10	11,18	32
2-302-18-2-0	7311518190620	10	11,18	32
2-303-14-2-0	7311518044176	10	8,90	32
2-303-14-D-1P	7311518189174	10	53,89	34
2-303-16-0-0	7311518108779	10	9,76	32
2-303-16-1-0	7311518020576	10	9,76	32
2-303-16-2-0	7311518020583	10	9,76	32
2-303-16-4-0	7311518108830	10	10,14	32
2-303-16-D-1P	7311518189198	1	72,31	34
2-303-18-0-0	7311518190644	10	11,18	32
2-303-18-2-0	7311518190668	10	11,18	32
2-304-14-0-0	7311518044183	10	10,14	32
2-304-14-2-0	7311518044190	10	10,14	32
2-304-14-4-0	7311518108878	10	10,93	32
2-304-14-D-1P	7311518189204	10	59,30	34
2-304-16-0-0	7311518020590	10	11,18	32
2-304-16-1-0	7311518020606	10	11,18	32
2-304-16-2-0	7311518020613	10	11,18	32
2-304-16-4-0	7311518020620	10	11,81	32
2-304-16-D-1P	7311518189211	10	79,30	34
2-304-18-0-0	7311518190712	10	12,92	32
2-304-18-2-0	7311518190736	10	12,92	32
2-305-16-1-0	7311518020637	10	11,18	32
2-305-16-2-0	7311518108908	10	11,18	32



2-306-14-D-1P	7311518189228	1	59,30	35
2-306-16-1-0	7311518020644	10	11,18	32
2-306-16-2-0	7311518108854	10	11,18	32
2-307-14-0-0	7311518044206	10	7,73	32
2-307-14-2-0	7311518044213	10	7,73	32
2-307-14-4-0	7311518108885	10	8,15	32
2-307-14-D-1P	7311518189235	10	53,89	35
2-307-16-0-0	7311518020651	10	8,39	32
2-307-16-1-0	7311518020668	10	8,39	32
2-307-16-2-0	7311518020675	10	8,39	32
2-307-16-4-0	7311518020682	10	8,90	32
2-307-16-D-1P	7311518189242	10	72,31	35
2-307-18-0-0	7311518190965	10	9,76	32
2-307-18-2-0	7311518190972	10	9,76	32
2-308-14-2-0	7311518044220	10	10,14	32
2-308-14-D-1P	7311518189259	1	59,30	35
2-308-16-0-0	7311518108861	10	11,18	32
2-308-16-1-0	7311518020699	10	11,18	32
2-308-16-2-0	7311518020705	10	11,18	32
2-309-16-2-0	7311518108946	10	9,76	32
2-309-16-4-0	7311518191054	10	10,14	32
2-313-16-0-0	7311518191177	10	11,18	32
2-470-14-0-0	7311518191191	10	47,92	33
2-470-14-2-0	7311518109080	10	46,75	33
2-470-14-4-0	7311518191207	10	51,03	33
2-470-16-1-0	7311518010942	10	49,21	33
2-470-16-2-0	7311518109097	10	50,75	33
2-471-16-1-0	7311518010959	5	83,52	33
2-472-14-0-0	7311518191214	5	91,20	34
2-472-14-2-0	7311518109103	5	91,20	34
2-472-16-0-0	7311518191238	5	98,42	34
2-472-16-1-0	7311518010966	5	98,42	34
2-472-16-2-0	7311518108922	5	98,42	34
2010	7314151584610	1	3.208,08	442
202A	7314150476220	5	167,22	652
204030150	8413345400855	12	15,58	550
204030160	8413345400862	12	16,62	550
204030180	8413345400879	12	17,51	550
204050130	8413345097970	6	26,52	550
204530140	8413345097918	12	18,58	551
204550130	8413345097956	6	28,58	551
2045A3000	8413345097932	12	20,25	551
2047-0-8-4	7314151060459	5	6,37	229
2047-1-5-5	7314151060473	5	7,77	229
2047-1-2-8	7314151060480	5	9,95	229
2047-1-6-10	7314151060497	1	13,66	229
2047-2-12	7314151060503	1	19,91	229
2047PR-1-2	7314151060558	5	8,00	229
2047PR-3-4	7314151060565	5	13,22	229
2047PZ-1-2	7314150216390	5	8,19	229
204B	7314150476244	5	167,22	653
2058-BR	7314151849290	1	10,24	84
2058/S26	7314151849276	1	37,76	168
2058/S26-2	7314151849283	1	37,77	168
2058/S26AF	7314150516308	1	24,22	168
208	7311518017545	5	16,53	556
209027040	8413345400947	12	16,20	550
209227060	8413345400961	12	15,73	551
209228100	8413345099233	12	16,62	551
209250100	8413345099585	6	28,16	551
210	7315965100379	10	31,80	556
2100PD-150	7314150205691	5	31,36	234
2101D-125	7314150106387	5	20,07	232
2101D-125IP	7314150106431	5	18,48	232
2101D-140	7314150106394	5	20,07	232
2101D-140IP	7314150106325	5	18,48	232
2101D-160	7314150106400	5	20,41	232
2101D-160IP	7314150106318	5	18,80	232
2101D-180	7314150106417	5	22,20	232
2101D-180IP	7314150106448	5	20,60	232
2101G-125	7314150106462	5	24,00	232
2101G-125IP	7314150106516	5	22,42	232
2101G-125IPD	7314150335039	5	22,42	232
2101G-140	7314150106479	5	24,42	232
2101G-140IP	7314150106288	5	22,83	232
2101G-140IPD	7314150335053	5	22,83	232
2101G-160	7314150106486	5	24,92	232
2101G-160IP	7314150106295	5	23,37	232
2101G-160IPD	7314150335060	5	23,37	232
2101G-180	7314150106493	5	26,66	232
2101G-180IP	7314150106523	5	25,04	232
2101G-180IPD	7314150335077	5	25,04	232
2101GC-125IP	7314150106547	5	22,78	232
2101GC-140IP	7314150106554	5	22,90	232
2101GC-160IP	7314150106561	5	23,85	232
2101GC-180IP	7314150106578	5	25,99	232
2101PG-160	7314150113972	5	53,99	232
2101S-140	7314150106592	3	26,11	498
2101S-160	7314150106608	3	28,14	498
2101S-180	7314150106615	3	31,47	498
2101S-200	7314150106622	3	38,80	499
211035180	8413345000147	5	8,02	551
211042210	8413345000154	5	10,49	551
212027180	8413345000178	5	6,20	551
212033250	8413345129435	8	6,72	551
212202500	8413345110266	10	20,97	552



212302900	8413345110280	10	15,60	552
212502150	8413345110303	10	12,58	552
212602150	8413345110327	10	14,75	552
212602800	8413345129404	1	19,33	552
212704350	8413345122184	6	41,66	551
212A	7314150420827	10	193,56	653
213026140	8413345000185	5	5,14	551
2145020D0	8413345097994	1	13,02	551
2145020L0	8413345098045	1	13,02	551
2145025C0	8413345098083	1	13,59	552
2145025D0	8413345098007	1	13,16	551
2145025L0	8413345098052	1	13,16	551
2145030D0	8413345098014	1	13,33	551
2145030L0	8413345098069	1	13,33	551
2145035D0	8413345098021	1	13,59	551
2145035L0	8413345098076	1	13,59	551
2145039C0	8413345098090	1	13,93	552
2145PD-150	7314150114009	5	50,54	236
215-150	7311518017576	1	7,02	558
215000030	8413345131971	12	4,52	549
215000040	8413345131988	12	4,69	549
215000050	8413345131995	12	4,87	549
215000060	8412243557944	12	5,00	549
215000070	8413345132008	12	5,39	549
215000080	8413345132015	12	5,70	549
215000090	8413345132022	12	6,14	549
215000100	8413345132039	12	6,89	549
215000120	8413345132046	12	8,45	549
215500300	7314150220120	12	7,42	549
215500400	8413345122627	12	8,07	549
215500500	8413345122641	12	8,28	549
215500600	8413345122665	12	8,44	549
215500700	8413345122689	12	8,64	549
215500800	8413345122702	12	9,04	549
215500900	8413345137478	12	9,23	549
215501000	8413345122726	12	9,63	549
216-150-R	7311518017583	1	7,02	558
216-300-R	7311518017798	1	10,34	558
216000300	8413345403658	12	3,84	549
216000400	8413345403665	12	3,95	549
216000500	8413345403672	12	4,15	549
216000600	8413345403689	12	4,26	549
216000700	8413345403696	12	4,59	549
216000800	8413345403702	12	4,82	549
216000900	8413345403719	12	5,09	549
216001000	8413345403726	12	5,84	549
216001200	8413345403740	12	6,84	549
216100040	8413345132053	12	8,35	549
216100060	8413345132091	12	9,79	549
216100080	8413345132060	12	11,00	549
216100100	8413345132077	12	11,64	549
216100120	8413345132084	12	12,58	549
216500300	8413345407274	12	7,32	549
216500500	8413345407281	12	7,75	549
216500750	8413345407298	12	9,79	549
216501000	8413345407304	12	11,00	549
2171G-140	7314150116232	5	18,87	234
2171G-160	7314150116133	5	19,47	234
2171G-180	7314150116140	5	21,49	234
2171V-160	7314150126798	2	41,49	499
2171V-180	7314150126804	2	44,49	499
2171V-200	7314150466009	2	48,05	499
218	7311518017521	10	4,14	557
218-BULK	7311518140946	150	2,88	557
219	7311518140953	120	5,40	557
219001000	8413345029865	5	6,58	549
219001200	8413345029872	5	7,28	549
219001400	8413345029889	5	8,14	549
219001600	8413345029896	5	8,86	549
219002000	8413345029902	5	11,63	549
2190PD-150	7314150114016	5	53,43	237
219201000	8413345029667	5	10,66	549
219201200	8413345029674	5	11,67	549
219201400	8413345029681	5	14,32	549
219201600	8413345029698	5	15,88	549
219202000	8413345029704	5	19,94	549
219302500	8413345129466	10	18,70	549
219303000	8413345129473	10	20,07	549
219303500	8413345129480	10	21,41	549
21HDD-140	7314150231256	5	22,93	233
21HDD-140IP	7314150231263	5	21,34	233
21HDD-160	7314150231270	5	23,53	233
21HDD-160IP	7314150231287	5	21,97	233
21HDD-180	7314150231294	5	25,73	233
21HDD-180IP	7314150231300	5	24,13	233
21HDD-200	7314150231317	5	28,17	233
21HDD-200IP	7314150231324	5	26,57	233
21HDG-140	7314150231331	5	26,99	232
21HDG-140A	7314150237654	5	28,63	233
21HDG-140IP	7314150231348	5	25,40	232
21HDG-160	7314150231355	5	27,70	232
21HDG-160A	7314150237661	5	29,76	233
21HDG-160IP	7314150231362	5	26,11	232
21HDG-180	7314150231379	5	30,36	232
21HDG-180A	7314150237678	5	32,61	233
21HDG-180IP	7314150231386	5	28,77	232



21HDG-200	7314150231409	5	32,29	232
21HDG-200A	7314150238439	5	34,77	233
21HDG-200IP	7314150231416	5	30,71	232
21HDGC-140IP	7314150231423	5	26,58	233
21HDGC-160IP	7314150231430	5	27,66	233
21HDGC-180IP	7314150231447	5	30,04	233
21HDGC-200IP	7314150231454	5	31,59	233
221 D	7314150037070	5	14,72	248
221201200	8413345029711	5	5,50	550
221202000	8413345029728	5	6,71	550
221203000	8413345029735	5	9,80	550
221301200	8413345029742	5	5,50	550
221302000	8413345029759	5	6,53	550
221303000	8413345029766	5	9,80	550
222 D	7314150037087	5	15,22	248
22209004B	8413345401333	1	19,27	348
2223 D-150	7314150033591	5	29,12	252
2223 G-150	7314150113651	5	28,61	251
2223 S-150	7314150032983	3	33,03	500
2223V-160	7314150134113	2	52,01	501
223 D	7314150037094	5	16,22	248
2233 D-160	7314150114023	5	33,36	238
2233 D-200	7314150114030	5	40,98	238
2233 D-240	7314150114047	5	46,23	238
2233D-160IP	7314150114054	5	32,68	238
2233D-200IP	7314150114061	5	40,29	238
2233D-240IP	7314150114078	5	45,55	238
2235-160	7314150179695	1	50,46	238
224 D	7314150037100	5	18,29	248
225 D	7314150037117	5	27,98	248
225-PLUS	7311518029708	5	31,08	556
2250V-170	7314150128730	2	109,12	499
2250V-230	7314150128747	2	127,15	499
227-22	7314150419845	1	201,54	120
227-24	7314150419852	1	207,53	120
227-27	7314150419869	1	213,62	120
227-30	7314150419876	1	222,35	120
227-32	7314150419883	1	226,60	120
227-34	7314150419890	1	250,13	120
227-36	7314150419906	1	256,50	120
227-41	7314150419913	1	278,00	120
227-46	7314150419920	1	333,50	120
228	7311518014995	80	11,49	557
228-15-5P	7311518031442	10	4,14	558
228-22	7314150420070	1	224,50	121
228-24	7314150420087	1	224,50	121
228-27	7314150420094	1	224,50	121
228-30	7314150420100	1	233,43	121
228-32	7314150420117	1	238,02	121
228-32-100P	7311518150990	1	28,68	558
228-32-10P	7311518010867	10	4,90	558
228-32-5P	7311518031459	10	4,14	558
228-34	7314150420124	1	255,96	121
228-36	7314150420131	1	269,40	121
228-41	7314150420148	1	291,83	121
228-46	7314150420155	1	350,20	121
228-BULK	7311518009069	5	10,46	557
228-SD	7311518277048	24	23,68	153
228-SET-SD	7314150217946	1	130,27	154
229-SD	7311518277055	24	32,46	154
22F-3/4	7314150419821	1	250,98	119
22R-3/4	7314150419838	1	256,52	119
23-15	7311518274665	10	2,73	634
23-21	7311518012274	10	4,83	634
23-24	7311518003852	10	5,16	634
23-30	7311518003869	10	5,78	634
23-32	7311518003876	10	6,00	634
23-36	7311518003883	10	6,38	634
230-SD	7311518280956	25	72,93	154
2303B0000	8413345091404	6	18,26	550
2303D0000	8413345091428	6	19,25	550
2304C0000	8413345091565	6	22,80	550
2308A0000	8413345091602	6	18,67	550
2308B0000	8413345091626	6	19,37	550
232-SD	7314150214839	1	124,05	154
233-300	7311518044015	5	18,87	565
233-300-A	7311518044039	5	25,86	565
233-400	7311518044022	5	27,51	565
2339 D	7314150032792	3	20,18	236
2339 DIP	7314150103508	5	19,51	236
2339-220	7314150442461	5	16,09	237
2339-220IP	7314150101061	5	15,50	237
2339-250IP	7314150101078	5	17,43	237
2339-280IP	7314150101948	5	19,83	237
2339-300IP	7314150123865	6	26,50	237
2339D-300	7314150411245	5	24,44	236
2339D-300IP	7314150411238	6	23,85	236
234-A1	7311518013653	1	20,52	565
234-A2	7311518013660	1	21,67	565
234-SD	7314150214846	25	138,79	154
234-W1	7311518013608	10	8,72	565
234-W2	7311518013615	10	10,86	565
234-W3	7311518013622	10	14,04	565
238	7311518011314	60	11,71	557
239	7311518010874	150	5,81	557
2420 G-125	7314150102525	5	26,36	244



2420G-125IP



2420G-125IP	7314150447091	5	21,34	244
2421 D-140IP	7314150101979	5	22,81	245
2421 D-160IP	7314150101986	5	25,14	245
2421 D-180IP	7314150101993	5	29,99	245
2421 G-140	7314150102532	5	27,86	244
2421 G-140IP	7314150102006	5	27,16	244
2421 G-160	7314150102549	5	30,62	244
2421 G-160 IP	7314150100576	5	29,90	244
2421 G-180	7314150102556	5	36,78	244
2421 G-180 IP	7314150100583	5	36,08	244
2421GC-140IP	7314150447107	5	22,78	244
2421GC-160IP	7314150447114	5	25,04	244
2421GC-180IP	7314150233229	5	25,39	244
2421S-140	7314150447121	3	32,60	500
2421S-160	7314150447138	3	32,60	500
2421S-180	7314150447145	3	43,32	500
2421V-160	7314150126774	2	38,70	500
2427 D-160	7314150032846	5	27,01	243
2427 D-200	7314150169030	5	29,20	243
2427 G-160	7314150100408	5	29,47	243
2427 G-160 IP	7314150100743	5	28,77	243
2427 G-200	7314150100415	5	33,70	243
2427 G-200 IP	7314150100750	5	33,03	243
2427 GC-160IP	7314150102051	5	24,56	243
2427 GC-200IP	7314150102075	5	28,14	243
2427 S-200	7314150033027	3	33,98	500
2427S-160	7314150447008	3	33,72	500
2427V-200	7314150126903	2	52,01	500
2430 D-140	7314150032853	5	23,96	241
2430 D-140 IP	7314150100774	5	23,30	241
2430 D-160	7314150032860	5	25,85	241
2430 D-160 IP	7314150100781	5	25,13	241
2430 D-200	7314150032884	5	28,02	241
2430 D-200 IP	7314150100804	5	27,33	241
2430 G-140	7314150102563	5	27,09	241
2430 G-140 IP	7314150102143	5	26,41	241
2430 G-160	7314150024070	5	28,61	241
2430 G-160 IP	7314150100811	5	27,91	241
2430 G-200	7314150100422	5	32,82	241
2430 G-200 IP	7314150100835	5	32,13	241
2430 GC-140 IP	7314150102150	5	22,58	241
2430 GC-160 IP	7314150102167	5	23,61	241
2430 GC-200 IP	7314150102174	5	27,18	241
2430 S-160	7314150206742	3	27,76	500
2430 S-200	7314150033010	3	30,43	500
2430S-140	7314150446995	3	27,11	500
2430V-160	7314150126880	2	46,13	500
2430V-200	7314150126897	2	46,45	500
2431G-125	7314150447015	5	25,58	241
2431G-125IP	7314150447053	5	25,10	241
2431G-140	7314150447022	5	26,11	241
2431G-140IP	7314150447060	5	25,55	241
2431G-160	7314150447039	5	26,58	241
2431G-160IP	7314150447077	5	25,99	241
2431G-180	7314150447046	5	27,55	241
2431G-180IP	7314150447084	5	26,82	241
244-20-U7/8-HP	7311518012519	10	24,44	563
244-22-U7/8-HP	7311518012526	10	25,42	563
2446	7314150128648	15	11,09	583
2446-BL	7314150508242	15	9,37	583
2446-EL	7314150270736	12	9,38	584
2446-EL-HELP	7314150394500	12	10,25	584
2446-ELL	7314150370153	12	9,38	584
2446-ELR	7314150370146	12	9,38	584
2446-LAP	7314150508228	15	8,34	583
2446-LINO	7314150270750	12	8,72	583
2446-OV	7314150313662	15	11,09	584
2446-SAFE	7314150453078	15	9,13	583
2448	7314150136049	12	29,91	572
2449	7314150194056	12	27,49	572
244P-20-U7-HP	7311518235499	4	27,49	565
244P-22-U7-HP	7311518235482	10	28,55	565
2460	7314151063467	1	52,85	251
2461 C19	7314151063498	1	73,95	249
2461 C40	7314151063504	1	85,06	249
2461 C8	7314151063481	1	71,36	249
2463 D19	7314151063511	1	75,85	249
2463 D40	7314151063528	1	87,19	249
2463 D8	7314151588878	1	62,29	249
2464 A10	7314151063535	1	77,10	250
2464 A19	7314151063542	1	83,87	250
2464 A3	7314151406516	1	77,10	250
2464 A40	7314151063559	1	92,02	250
2465D-200	7314150120826	1	58,81	251
2466 B10	7314151063573	1	78,60	250
2466 B19	7314151063580	1	85,90	250
2466 B3	7314151406868	1	78,60	250
2466 B40	7314151063597	1	96,73	250
247-24	7314150367078	1	191,71	117
247-27	7314150367085	1	191,71	117
247-30	7314150367092	1	194,22	117
247-32	7314150367108	1	194,22	117
247-34	7314150367115	1	194,22	117
247-36	7314150367122	1	199,22	117
247-41	7314150367139	1	199,22	117
247-46	7314150367146	1	202,97	117



247-50	7314150367153	1	207,98	117
247-55	7314150367160	1	214,26	117
247-60	7314150367177	1	218,01	117
2470 G-160	7314150116188	5	18,30	242
2470 G-200	7314150116195	5	20,33	242
2471 G-160	7314150116225	5	16,75	245
2477 G-200	7314150116201	5	22,66	244
2477G-160	7314150134977	5	17,88	244
248-24	7314150367818	1	195,46	118
248-27	7314150367825	1	195,46	118
248-30	7314150367832	1	200,47	118
248-32	7314150367849	1	200,47	118
248-34	7314150367856	1	200,47	118
248-36	7314150367863	1	204,23	118
248-41	7314150367870	1	214,26	118
248-46	7314150367887	1	209,25	118
248-50	7314150367894	1	209,25	118
248-55	7314150367900	1	255,59	118
248-60	7314150367917	1	255,59	118
2484-20	7314150233250	1	9,86	370
2484-30	7314150233267	1	12,68	370
2484-45	7314150233274	1	19,71	370
2484-60	7314150233281	1	23,94	370
2484/S4	7311518276553	10	49,30	370
2484T-20	7314150455102	1	13,20	370
2484T-30	7314150455119	1	18,86	370
2484T-45	7314150455126	1	25,76	370
2484T-60	7314150455133	1	30,45	370
2484T/S4	7314150455096	1	79,47	370
2485	7314150242382	1	9,31	348
2487	7311518276058	12	17,36	536
2488	7311518276072	12	19,19	550
2489	7311518276065	12	23,59	550
24A-14	7314150368235	1	111,51	119
24A-27	7314150368242	1	176,67	119
24F-1	7314150366231	1	269,38	116
24F-3/4	7314150366224	1	230,54	116
24R-1	7314150365951	1	300,70	115
24R-3/4	7314150365944	1	181,68	115
24T-1	7314150366156	1	363,36	116
24T-3/4	7314150366149	1	275,64	116
24W	7314150368266	1	68,92	119
2500-16-XT-HP	7311518160159	4	44,19	563
2500-19-XT-HP	7311518160722	4	45,55	563
2500-22-XT-HP	7311518140922	4	46,88	563
2500-24-XT-HP	7311518181338	4	48,72	563
250400010	7314150314430	1	40,88	552
250400020	7314150393008	1	72,11	552
250400030	7314150393015	1	135,47	552
250501800	8413345128964	50	65,87	552
250502450	8413345128957	1	73,38	553
2509	7314151064280	50	77,31	371
2520	7314150023752	1	175,48	238
2521 G-140	7314150100293	5	27,65	246
2521 G-160 IP	7314150100620	5	28,59	246
2521D-140IP	7314150447176	5	19,98	246
2521D-160IP	7314150447183	5	23,54	246
2521G-140IP	7314150447169	5	28,02	246
2521G-160	7314150447152	5	30,47	246
2521S-140	7314150447190	3	32,34	500
2521S-160	7314150447206	3	34,03	500
2521V-160	7314150126781	2	39,32	500
2530	7314150326761	1	6,65	371
2530-40	7314151317294	5	46,82	536
2535F0	7314150402236	1	17,87	371
2535F1	7314151064495	1	39,39	371
2535F2	7314150233854	1	35,69	371
2535F3	7314150180233	1	64,65	371
2535L	7314150125357	12	27,29	371
255-17/34	7314150272372	2	56,84	561
255-34	7314150272365	2	64,84	561
2555	7311518276041	1	8,19	308
256-26	7311518000080	4	69,39	561
2600-16-XT11-HP	7311518239527	4	56,58	562
2600-19-XT-HP	7311518160760	4	58,75	563
2600-22-XT-HP	7311518160777	4	60,55	563
2620-80	7311518200947	1	283,66	238
2628 D-160	7314150123193	5	20,81	240
2628 D-180	7314150042661	5	23,80	240
2628 D-200	7314150123315	5	25,04	240
2628 G-160	7314150042999	5	24,76	239
2628 G-160IP	7314150055357	5	24,06	239
2628 G-180	7314150042678	5	27,17	239
2628 G-180IP	7314150044030	5	26,50	239
2628 G-200	7314150103539	5	28,98	239
2628 GC-160IP	7314150101863	5	19,20	239
2628 GC-180IP	7314150101870	5	20,74	239
2628 GC-200IP	7314150101887	5	22,81	239
2628 S-160	7314150206735	3	29,81	499
2628 S-180	7314150044054	3	33,03	499
2628 S-200	7314150043002	3	36,12	499
2628G-200IP	7314150101085	5	28,30	239
2629G-160	7314150446933	5	24,76	240
2629G-160IP	7314150446964	5	24,06	240
2629G-180	7314150446940	5	27,09	240
2629G-180IP	7314150446971	5	26,50	240

			€	
2629G-200	7314150446957	5	28,98	240
2629G-200IP	7314150446988	5	28,30	240
2630DC-160IP	7314150446896	5	17,89	240
2630DC-180IP	7314150446902	5	19,08	240
2630DC-200IP	7314150446919	5	21,93	240
2630GC-160IP	7314150180165	5	19,79	240
2630GC-180IP	7314150180172	5	19,94	240
2630GC-200IP	7314150180189	5	22,81	240
2630SC-180	7314150446926	3	25,27	499
2632	7314151065706	1	23,03	370
2633/S4	7311518276942	12	25,87	535
2633HD/S6	7314150205783	1	132,85	315
2633HD1	7314150230464	1	43,12	315
2633HD2	7314150230471	1	19,07	315
2633HD3	7314150230488	1	16,54	315
2633HD4	7314150230495	1	12,77	315
2633HD5	7314150230501	1	12,04	315
2633HD6	7314150230518	1	6,95	315
2633L/S4	7311518276959	12	26,36	535
2635	7311518276348	1	60,64	609
2640D-160	7314150123766	10	19,22	240
2640D-180	7314150123773	5	21,78	240
2640D-200	7314150123797	5	24,47	240
2646	7314151304638	1	81,78	235
2646 A	7314151304645	1	93,07	235
2646 AK	7314151396619	1	89,31	235
2646 K	7314151495862	1	92,61	235
2646 M	7314151487928	1	90,63	235
2646 MF	7314151573683	1	70,59	245
2646 MS	7314151573768	1	78,26	246
2646 R	7314151304706	1	76,82	235
2646 RA	7314151834838	1	90,77	235
2646 RK	7314151496678	1	116,15	235
2648	7314151304713	1	77,28	235
2648 A	7314151304720	1	110,33	235
2649	7314150058013	1	87,60	235
2650	7314151065829	1	72,70	248
2650 B	7314151065843	1	6,47	248
2656	7314151304737	1	84,98	237
2656 R	7314151473976	1	81,35	244
2656 S	7314150058044	1	65,15	242
2666	7314150058006	1	81,78	235
2666 FK	7314151066079	1	96,00	235
2674 NB	7314151066321	1	82,39	234
2674 NVDE	7314151498535	1	86,16	499
2676 B	7314151066390	1	85,24	235
2678 B	7314151066468	1	95,22	235
2678 G-160	7314150116157	5	16,08	241
2678 G-180	7314150116164	5	17,10	241
2678 G-200	7314150116171	5	18,48	241
2678V-160	7314150126835	2	41,78	499
2678V-180	7314150126842	2	45,55	499
2678V-200	7314150126859	2	48,99	499
268	7311518017538	5	13,18	557
2681	7311518276706	12	40,48	263
2681-1	7314150116980	1	3,46	264
2688D-250	7314150123520	3	41,56	240
2690	7314150411108	10	58,30	263
26S-1216	7314151830236	8	26,48	59
26S-16	7314150345588	5	7,55	59
26S-610	7314151830229	10	11,34	59
2700-22-XT7-HP	7311518191672	4	61,71	565
2700-24-XT7-HP	7311518191665	4	62,60	565
2704A	7314151066963	1	35,54	579
2705R	7314151821470	1	30,73	579
2720	7314150179701	1	243,06	238
2720-SH	7314150179718	1	185,86	238
2744	7314151809096	6	21,88	579
277-30	7314150367184	1	214,26	117
277-32	7314150367191	1	214,26	117
277-34	7314150367207	1	214,26	117
277-36	7314150367214	1	219,26	117
277-41	7314150367221	1	240,56	117
277-46	7314150367238	1	245,57	117
277-50	7314150367245	1	251,85	117
277-55	7314150367252	1	259,35	117
277-60	7314150367269	1	264,37	117
278-30	7314150367924	1	243,06	118
278-32	7314150367931	1	243,06	118
278-34	7314150367948	1	243,06	118
278-36	7314150367955	1	246,82	118
278-41	7314150367962	1	259,35	118
278-46	7314150367979	1	253,09	118
278-50	7314150367986	1	253,09	118
278-55	7314150367993	1	255,59	118
278-60	7314150368006	1	255,59	118
2784-2.5	7314150215607	1	35,78	214
2784-3.5	7314150215614	1	35,78	214
2784-4.5	7314150215621	1	35,78	214
2787 F	7314151474270	1	120,36	236
2787 G	7314150058020	1	131,42	236
27A-24	7314150368259	1	209,25	119
27F-1	7314150366248	1	319,51	116
27M-10-11	7314150180523	10	14,24	58
27M-12-13	7314150180547	10	16,82	58
27M-13-17	7314150180790	10	22,41	58

			€	
27M-14-15	7314150180554	10	18,80	58
27M-16-17	7314150180561	10	21,81	58
27M-16-18	7314150180806	10	23,19	58
27M-18-19	7314150180578	10	26,05	58
27M-20-22	7314150180585	10	29,72	58
27M-21-23	7314150180592	5	33,05	58
27M-21-24	7314150180813	5	34,52	58
27M-24-26	7314150180608	5	35,30	58
27M-24-27	7314150180820	5	35,92	58
27M-25-28	7314150180622	5	40,60	58
27M-27-29	7314150180639	5	46,37	58
27M-30-32	7314150180646	5	51,96	58
27M-6-7	7314150180509	10	13,27	58
27M-8-9	7314150180516	10	13,41	58
27M/10	7314150180677	1	222,42	59
27M/12	7314150180684	1	315,00	59
27M/12T	7314150180783	1	321,27	58
27M/6	7314150180653	1	98,35	58
27M/8	7314150180660	1	154,09	59
27M/8T	7314150180776	1	158,28	58
27R-1	7314150365968	1	344,56	115
27T-1	7314150366163	1	400,94	116
28-29/S4	7314150179688	1	107,34	251
2800 N	7314151318338	1	69,98	239
2800-140	7314150121632	3	19,69	249
2800-150	7314150034567	3	19,69	249
2800-180	7314150034581	3	22,48	249
2800-225	7314150034604	3	28,30	249
2800-300	7314150122622	1	38,80	249
2801 N	7314151318352	1	86,23	239
2804	7314151692698	1	436,26	238
2805-280	7314151826123	1	510,21	238
2820EF1	7314150122042	12	9,58	585
2820EF2	7314150122059	8	12,32	586
2820EF3	7314150122066	1	15,95	586
2820EF4	7314150122073	1	19,93	586
2820EK	7314150122035	6	7,68	585
2820EK-01	7314150270743	12	6,02	585
2820VBC	7314150121915	1	227,32	499
2820VDE	7314151605476	10	24,33	503
2820VFP	7314150121922	1	122,19	503
2820VG05	7314150121953	1	68,52	503
2820VG10	7314150121960	1	82,41	503
2820VGCOT	7314150121977	1	4,89	503
2820VHELP	7314150121908	1	59,99	503
2820VM	7314150121946	1	227,90	503
2820VP	7314150121885	2	30,08	502
2820VPC	7314150121892	2	32,63	503
2820VTEE	7314150121939	1	32,29	503
2855	7314151825805	1	154,37	264
2855 D	7314151822569	1	195,42	264
2856-10	7314150437214	1	314,51	264
2856-8	7314150437207	1	314,51	264
2890-125	7314150122639	3	17,07	249
2890-140	7314150034550	3	20,00	249
2890-180	7314150034574	3	23,20	249
2890-210	7314150034598	3	29,20	249
2890-300	7314150122646	1	43,62	249
28M-10	7314151834678	5	13,21	56
28M-11	7314151834685	5	13,80	56
28M-12	7314151834692	5	14,63	56
28M-13	7314151834708	5	15,71	56
28M-14	7314151834715	5	18,00	56
28M-15	7314151834722	5	19,07	56
28M-16	7314151834739	5	20,11	56
28M-17	7314151834746	5	20,93	56
28M-18	7314151834753	3	25,25	56
28M-19	7314151834760	3	26,65	56
28M-20	7314150122561	3	28,56	56
28M-21	7314151834777	3	31,05	56
28M-22	7314151834784	3	36,06	56
28M-23	7314150122578	3	37,55	56
28M-24	7314151834791	3	39,80	56
28M-25	7314150122585	3	45,42	56
28M-26	7314150122592	3	49,33	56
28M-27	7314151834807	3	53,87	56
28M-28	7314150122608	1	62,03	56
28M-29	7314150122615	1	70,73	56
28M-30	7314151834814	1	80,27	56
28M-32	7314151834821	1	95,67	56
28M-6	7314151834630	5	14,75	56
28M-7	7314151834647	5	15,36	56
28M-8	7314151834654	5	12,64	56
28M-9	7314151834661	5	12,52	56
28M/11	7314151838126	1	200,05	57
28M/12	7314151838133	1	209,34	57
28M/15	7314151838140	1	316,26	57
28M/8	7314151838119	1	145,69	57
28MV-10	7314150121298	2	36,85	501
28MV-11	7314150121304	2	37,32	501
28MV-12	7314150121311	2	37,65	501
28MV-13	7314150121328	2	37,97	501
28MV-14	7314150121335	2	42,54	501
28MV-15	7314150121342	2	43,03	501
28MV-16	7314150121359	2	44,18	501
28MV-17	7314150121366	2	44,81	501



28MV-18



28MV-18	7314150121373	2	46,07	501
28MV-19	7314150121380	2	46,07	501
28MV-20	7314150121397	2	45,92	501
28MV-21	7314150121403	2	46,24	501
28MV-22	7314150121410	2	48,45	501
28MV-8	7314150121274	2	36,51	501
28MV-9	7314150121281	2	36,51	501
29-B	7311518277703	1	32,32	328
2900-140	7314150121045	3	21,00	250
2900-150	7314150034499	3	21,00	250
2900-180	7314150034512	3	22,92	250
2900-215	7314150034536	3	28,30	250
2900-300	7314150121076	1	44,22	250
2928-1	7314150056583	1	15,38	250
2928-160	7314150056514	1	57,14	250
2928-2	7314150056590	1	15,38	250
2928-200	7314150056521	1	80,66	250
2928-250	7314150056538	1	115,36	250
2928-3	7314150056606	1	15,38	250
2928-4	7314150056613	1	15,38	250
2949-190IP	7314150123926	1	62,31	262
2949-200IP	7314150123940	1	66,10	262
2949-240IP	7314150123957	1	69,28	262
2949-250IP	7314150123971	1	86,07	262
2949-L075	7314150440559	1	5,72	263
2949-L120	7314150440566	1	5,96	263
2949-L200	7314150440573	1	7,33	263
2950-250	7314150124039	1	33,98	261
2951-140	7314150124084	1	18,13	259
2951-180	7314150102204	1	24,78	259
2951-250	7314150102211	1	28,54	259
2951-300	7314150102228	1	48,04	259
2951-S05	7314150447299	1	3,62	262
2951-S07	7314150447305	1	3,62	262
2951-S10	7314150447312	1	3,62	262
2951-S12	7314150447329	1	3,62	262
2952-165	7314150103836	1	21,58	260
2952-235	7314150103843	1	30,82	260
2953-140	7314150124046	1	16,93	259
2953-200	7314150124053	1	22,51	259
2953-250	7314150124060	1	25,69	259
2953-300	7314150124077	1	44,40	259
2955-250	7314150102235	1	32,47	260
2956-290	7314150413690	1	44,71	261
2957-250	7314150102259	1	27,03	260
2958-140	7314150124107	1	17,97	259
2958-200	7314150124114	1	24,78	259
2958-250	7314150102242	1	28,54	259
296	7311518034146	1	151,32	567
2960-280	7314150412808	1	54,25	261
2962-8-150	7314150412815	1	56,87	261
2962-8-230	7314150413706	1	73,09	261
2962-8-300	7314150413713	1	79,28	261
2963-280	7314150102280	1	37,91	261
2963-450	7314150124138	1	62,22	261
2963-630	7314150124145	1	74,83	261
2964-160	7314150124183	1	31,26	261
2964-280	7314150102297	1	41,22	261
2964-450	7314150124190	1	69,61	261
2964-600	7314150124206	1	81,53	261
2965-200	7314150124152	1	32,62	262
2965-280	7314150102266	1	43,20	262
2966-280	7314150102273	1	44,24	262
2967-180	7314150102396	1	39,27	260
2968-190	7314150124091	1	24,78	259
2968-235	7314150103850	1	28,54	259
2970G-200	7314150134946	5	17,24	241
2971G-250	7314150117154	5	15,53	248
2979 D-180	7314150034246	5	41,08	246
2990-125	7314150121250	3	21,51	250
2990-140	7314150034482	3	21,51	250
2990-180	7314150034505	3	24,17	250
2990-200	7314150034529	3	29,20	250
2990-300	7314150121267	1	43,05	250
2997-250	7314150124237	1	67,97	262
2997-300	7314150124244	5	74,89	262
2998-250	7314150124213	1	91,97	260
2998-SHN	7314150447275	1	53,65	260
2999-250	7314150124169	1	48,62	260
2999-SHN	7314150447282	1	14,31	260
29M-10	7314150122318	5	13,21	57
29M-11	7314150122325	5	13,71	57
29M-12	7314150122332	5	14,85	57
29M-13	7314150122349	5	15,40	57
29M-14	7314150122356	5	18,00	57
29M-15	7314150122363	5	19,07	57
29M-16	7314150122370	5	20,11	57
29M-17	7314150122387	5	20,29	57
29M-18	7314150122394	3	25,25	57
29M-19	7314150122400	3	26,65	57
29M-20	7314150122417	3	28,56	57
29M-21	7314150122424	3	31,05	57
29M-22	7314150122431	3	36,06	57
29M-23	7314150122448	3	37,55	57
29M-24	7314150122455	3	39,80	57
29M-25	7314150122462	3	45,42	57



29M-26	7314150122479	3	49,33	57
29M-27	7314150122486	3	53,87	57
29M-28	7314150122493	1	62,03	57
29M-29	7314150122509	1	70,73	57
29M-30	7314150122516	1	80,27	57
29M-32	7314150122523	1	95,67	57
29M-6	7314150122271	5	14,75	57
29M-7	7314150122288	5	15,36	57
29M-8	7314150122295	5	13,22	57
29M-9	7314150122301	5	13,13	57
29M/10	7314150122547	1	178,12	57
29M/14	7314150122554	1	309,50	57
29M/8	7314150122530	1	158,79	57
2M-10-11	7314151001223	5	12,03	52
2M-10-13	7314151001513	5	15,25	52
2M-12-13	7314151001230	5	12,93	52
2M-13-17	7314151343972	5	14,11	52
2M-14-15	7314151001247	5	13,71	52
2M-16-17	7314151001254	5	16,38	52
2M-16-18	7314151001575	5	19,57	52
2M-17-19	7314151000844	5	19,09	52
2M-18-19	7314151001261	5	19,09	52
2M-19-22	7314151000868	5	22,57	52
2M-20-22	7314151001278	5	23,42	52
2M-21-23	7314151001285	5	25,00	52
2M-22-24	7314151001612	5	27,27	52
2M-24-26	7314151001292	5	30,90	52
2M-24-27	7314151000899	5	31,38	52
2M-25-28	7314151001308	5	36,04	52
2M-27-29	7314150205332	5	37,07	52
2M-27-30	7314151001636	5	44,08	52
2M-27-32	7314151001322	5	44,08	52
2M-30-32	7314151000929	5	43,95	52
2M-32-36	7314151001667	1	64,57	52
2M-36-41	7314151001681	1	76,69	52
2M-41-46	7314151001704	1	101,37	52
2M-46-50	7314151001711	1	125,12	52
2M-6-7	7314151001209	5	10,38	52
2M-8-10	7314151001506	5	13,18	52
2M-8-9	7314151001216	5	11,37	52
2M/10T	7314150212996	1	180,51	52
2M/12T	7314151001414	1	259,43	53
2M/8T	7314151001391	1	122,05	52
2M/S8	7314151827335	1	117,86	52
2MV-10	7314150121113	5	30,73	501
2MV-11	7314150121120	5	31,01	501
2MV-12	7314150121137	5	31,01	501
2MV-13	7314150121144	5	33,26	501
2MV-14	7314150121151	5	34,19	501
2MV-15	7314150121168	5	35,46	501
2MV-16	7314150121175	5	35,95	501
2MV-17	7314150121182	3	37,05	501
2MV-18	7314150121199	3	37,71	501
2MV-19	7314150121205	3	38,97	501
2MV-21	7314150121212	3	41,01	501
2MV-22	7314150121229	3	41,32	501
2MV-23	7314150121236	3	44,02	501
2MV-24	7314150121243	3	45,44	501
2MV-6	7314150121069	5	28,70	501
2MV-7	7314150121083	5	28,70	501
2MV-8	7314150121090	5	30,22	501
2MV-9	7314150121106	5	30,82	501
2Z-1-1.1/8	7314151001827	1	36,83	52
2Z-1.1/16-1.1/4	7314151001834	1	40,75	52
2Z-1/2-9/16	7314151001445	1	13,15	52
2Z-1/4-5/16	7314151001421	1	11,85	52
2Z-13/16-7/8	7314151001797	1	22,57	52
2Z-15/16-1	7314151001810	1	31,08	52
2Z-3/4-7/8	7314151001773	1	22,57	52
2Z-3/8-7/16	7314151001438	1	13,25	52
2Z-5/16-3/8	7314151001728	1	11,58	52
2Z-5/8-11/16	7314151001452	1	16,81	52
2Z-9/16-5/8	7314151001735	1	14,11	52
2Z/7T	7314150217373	1	108,23	53
3-24-51	7315962500028	5	18,45	633
3-330-12-1-0	7311518020712	5	26,59	31
3-330-12-2-0	7311518020729	5	28,39	31
3-330-14-1-0	7311518020736	5	28,57	31
3-330-14-2-0	7311518020743	5	32,80	31
3-331-14-1-0	7311518020750	5	29,11	31
300-14-F15/16-HP	7311518005955	4	20,02	561
301	7311518001384	50	18,81	567
301-16	7314150456048	12	27,36	269
301-22	7311518293673	12	26,12	269
302	7311518013349	30	18,37	566
302-15-95	7314150486632	100	6,36	269
302-35	7311518293680	6	41,52	269
302-511W-12P	7311518207786	1	4,56	567
302-51W-12P	7311518013356	1	3,14	567
302-53W-12P	7311518013363	1	3,14	567
302-55W-12P	7311518013370	1	3,14	567
302-57W-12P	7311518013387	1	3,71	567
302-59W-12P	7311518207779	1	4,21	567
302-6X4P	7311518017590	1	10,01	567
302-71M-12P	7311518013394	1	5,22	567
302-73M-12P	7311518013400	1	5,23	567

			€	
302-75M-12P	7311518013417	1	6,29	567
302-76-95	7314150188345	1	6,12	269
302-76N	7314150456307	6	94,54	269
302-77M-12P	7311518207793	1	6,80	567
302-81S-12P	7311518013677	1	4,44	567
302-83S-12P	7311518013684	1	4,44	567
302-85S-12P	7311518207809	1	5,02	567
302-95-SET	7314150456321	1	24,87	269
303-5P	7311518031435	10	5,05	567
304	7311518265533	10	7,89	556
3045/1VDE	7314151783815	1	443,51	504
3045V-1	7314150128785	1	303,63	504
3045V-2	7314150128792	1	759,63	504
3046-OP	7311518276980	12	40,04	361
3046-REF	7311518276966	1	133,31	309
3049-2	7314151848118	1	538,96	464
306	7311518265540	10	15,14	556
306-10	7314150120246	1	31,36	268
306-12	7314150120253	1	33,14	268
306-15	7311518297107	12	34,89	268
306-15-95	7311518297329	1	12,06	269
306-22	7311518297114	12	38,37	268
306601500	8413345098700	5	22,08	588
306602000	8413345098717	5	23,74	588
306603000	8413345217033	5	26,71	588
306604000	8413345217095	5	29,38	588
306703000	8413345217194	5	28,78	588
306704000	8413345098755	5	31,16	588
306705000	8413345098762	5	33,97	588
306706000	8413345098779	5	36,20	588
306708000	8413345098786	5	41,53	588
306710000	8413345098793	5	47,19	588
306712000	8413345123334	2	53,11	588
306715000	8413345123341	2	60,82	588
306803000	8413345098809	5	51,48	588
306804000	8413345098816	5	54,90	588
306805000	8413345098823	2	58,04	588
306806000	8413345098830	2	60,74	588
306808000	8413345098847	2	66,59	588
306810000	8413345098854	2	71,71	588
306812000	8413345098861	2	76,09	588
306815000	8413345098878	1	82,73	588
306820000	8413345098885	1	90,85	588
306903000	8413345123402	2	82,77	588
306904000	8413345123419	2	85,88	588
306905000	8413345123426	2	88,99	588
306906000	8413345123433	2	91,98	588
306908000	8413345123457	2	98,06	588
306910000	8413345123471	2	103,99	588
307401B	7314150254958	1	34,16	268
307411B	7314150254965	1	51,07	268
307421B	7314150254972	1	82,35	268
307431B	7314150254989	1	136,83	268
307441	7314150235933	1	186,59	268
307451	7314150235940	1	273,66	268
308504000	8413345035156	1	19,08	544
308505000	8413345035194	1	20,94	544
308506000	8413345035163	1	24,19	544
308508000	8413345035170	1	29,43	544
308510000	8413345035187	1	33,04	544
3090-20-XT11-HP	7311518181369	4	55,49	563
31	7314150004942	5	37,25	40
31 IP	7314150004959	50	35,87	40
31-T	7314150483709	5	35,87	40
31-T IP	7314150483723	50	35,87	40
3100TB	7314150125364	1	61,13	466
310M-24	7314151829612	1	56,13	56
310M-27	7314151829629	1	56,13	56
310M-30	7314151829636	1	56,13	56
310M-32	7314151829643	1	59,59	56
310M-36	7314151829650	1	68,16	56
310M-38	7314151829667	1	82,01	56
310M-41	7314151829674	1	83,76	56
310M-46	7314151829681	1	93,39	56
310M-50	7314151829698	1	112,45	56
310M-55	7314151829704	1	125,86	56
310M-60	7314151829711	1	154,83	56
310M-65	7314151829728	1	175,07	56
310M-70	7314151829735	1	190,84	56
310M-75	7314151829742	1	208,17	56
310M-80	7314151829759	1	228,69	56
310M-85	7314151829766	1	246,05	56
310M-90	7314151829773	1	488,93	56
310M-95	7314151829780	1	529,93	56
311-32	7314150120215	6	21,63	270
3115	7314150055326	1	357,63	364
3149-OR	7311518292249	1	45,14	461
3149-ORFF1	7314150292479	1	561,43	460
3149-ORTS1	7314150292066	1	372,38	461
3150-12-XT9-HP	7311518181406	4	35,66	560
315M-27	7314150133291	1	75,44	56
315M-30	7314150133307	1	76,87	56
315M-32	7314150133314	1	75,44	56
315M-36	7314150133321	1	104,43	56
315M-41	7314150133345	1	107,36	56
315M-46	7314150133352	1	139,28	56

			€	
315M-50	7314150133369	1	156,67	56
315M-55	7314150133376	1	179,89	56
315M-60	7314150133383	1	232,10	56
315M-65	7314150133390	1	264,01	56
315M-70	7314150133406	1	307,54	56
315M-75	7314150133413	1	319,16	56
315M-80	7314150133420	1	368,46	56
315Z-1.1/16	7314150133437	1	69,63	56
315Z-1.1/2	7314150133505	1	94,21	56
315Z-1.1/4	7314150133468	1	75,44	56
315Z-1.1/8	7314150133444	1	69,63	56
315Z-1.11/16	7314150133529	1	113,17	56
315Z-1.13/16	7314150133543	1	124,75	56
315Z-1.15/16	7314150133567	1	136,34	56
315Z-1.3/16	7314150133451	1	72,54	56
315Z-1.3/4	7314150133536	1	121,86	56
315Z-1.3/8	7314150133482	1	98,63	56
315Z-1.5/16	7314150133475	1	78,34	56
315Z-1.5/8	7314150133512	1	110,26	56
315Z-1.7/16	7314150133499	1	92,59	56
315Z-1.7/8	7314150133550	1	133,46	56
315Z-2	7314150133574	1	136,34	56
315Z-2.1/16	7314150133581	1	139,28	56
315Z-2.1/2	7314150133642	1	205,99	56
315Z-2.1/4	7314150133611	1	159,57	56
315Z-2.1/8	7314150133598	1	140,63	56
315Z-2.15/16	7314150133697	1	258,21	56
315Z-2.3/16	7314150133604	1	152,36	56
315Z-2.3/4	7314150133673	1	214,71	56
315Z-2.3/8	7314150133635	1	168,29	56
315Z-2.5/16	7314150133628	1	162,47	56
315Z-2.5/8	7314150133666	1	214,71	56
315Z-2.7/8	7314150133680	1	255,32	56
315Z-2.9/16	7314150133659	1	211,80	56
315Z-3	7314150133703	1	264,01	56
315Z-3.1/8	7314150133840	1	269,82	56
316-1	7311518296216	12	13,38	271
316-2	7311518296223	12	20,05	271
316-2-95	7311518296278	1	10,56	271
317	7311518240936	10	19,50	556
317-40	7311518296230	12	13,48	271
318-38	7311518296247	1	84,17	271
318-54	7311518296254	1	134,86	271
3180-14-XT11-HP	7311518181390	4	50,20	562
319	7311518240943	5	26,91	556
320	7311518265557	10	22,40	556
321	7311518001841	5	35,64	556
321-18-SB	7311518129125	10	18,99	558
321-24-SB	7311518129132	10	19,30	558
321-7-SB	7311518129149	10	17,81	558
322500300	8413345012829	1	44,04	535
322500500	8413345012836	1	46,67	535
322500800	8413345012843	1	49,64	535
322510300	8413345015899	1	8,61	535
322510400	8413345137386	1	8,61	535
322510500	8413345015905	1	8,61	535
322510600	8413345137393	1	8,61	535
322510700	8413345137409	1	8,61	535
322510800	8413345015912	1	8,61	535
3240-14-XT11-HP	7311518243005	4	42,34	562
325	7311518214852	5	48,23	556
325001000	8413345000505	1	83,42	535
3250010SH	8413345137492	1	4,68	535
326000200	8413345000529	1	51,25	535
326000300	8413345012881	1	55,58	535
326010200	8413345016100	1	7,49	535
326020200	8413345016117	1	7,55	535
326030200	8413345016124	1	7,55	535
327020500	7314150330584	1	105,91	535
327020500-SH1	7314150361021	1	8,02	535
327020500-SH2	7314150361038	1	8,02	535
327020500-SH3	7314150361045	1	8,02	535
327020500-SH4	7314150361052	1	8,02	535
3280M	7314151071318	1	16,96	50
329000330	8413345000741	1	4,52	535
329000500	8413345000758	1	5,58	535
331-15-23	7311518274658	5	14,48	633
331-21-51-KP	7311518003814	5	15,49	633
332-21-51	7311518229337	5	18,34	633
333	7311518005832	5	29,45	633
333-5	7311518005849	10	7,29	634
339-6T	7311518128371	4	17,63	629
33H	7314150266791	5	66,38	40
340-6T	7311518002008	4	18,81	629
341	7314150113729	1	52,86	266
341 A	7314150216260	6	44,09	252
3416 A SH	7314150410941	1	16,68	252
3416 B	7314150411160	10	152,71	252
3416 B SH	7314150411191	10	59,49	252
3417 A	7314150216277	12	29,15	253
3418 A	7314150216284	1	35,19	252
3419 B	7314151812416	1	119,31	254
3419 B SH	7314150504381	1	36,18	254
341A	7314150476268	5	167,22	653
342	7314150113736	1	59,48	266
343	7314150113743	1	80,00	266





344	7314150113750	1	119,73	266
349	7311518018924	4	18,67	634
3517 A	7314150410910	1	34,89	253
3518 A	7314150216376	1	24,33	253
3518 A SH	7314150216383	1	5,70	253
3518 B	7314150410927	1	44,35	253
3520 A	7314150410934	1	33,74	252
3520 A SH	7314150410958	1	5,67	252
3520 B	7314150411177	10	103,61	252
3520 B SH	7314150411207	10	29,69	252
3524	7314151073336	1	34,88	536
3524L-K	7314151339807	1	16,75	536
3525HB	7314151073350	5	27,03	536
36	7314150223381	5	45,63	593
361-10	7311518295202	1	33,17	267
361-12	7311518295219	1	38,69	267
361-14	7311518295226	1	41,48	267
361-18	7311518295233	1	58,04	267
361-24	7311518295240	1	96,46	267
361-36	7311518295257	1	185,69	267
361-8	7311518295196	1	29,83	267
3619 A	7314150411184	10	52,34	253
3619 A SH	7314150411214	10	14,19	253
3625AR-35	7314150214723	34	34,29	596
3625AR-50	7314150214730	18	56,64	596
3625AR-60	7314150214747	12	73,69	596
3625ARL-35	7314150214754	6	1,40	596
3625ARL-50	7314150214761	6	5,54	596
3625ARL-60	7314150214778	6	9,27	596
3625ARLH-35	7314150218677	80	4,60	597
3625ARLH-50	7314150218684	50	4,86	597
3625ARLH-60	7314150218691	16	5,12	597
3625N-22	7314151073602	6	44,91	597
3625N-32	7314151073640	6	48,51	597
3625N-40	7314151073688	6	81,63	597
3625N-50	7314151073701	6	98,91	597
3625NL-22	7314151073831	20	12,59	598
3625NL-32	7314151073855	20	21,46	598
3625NL-40	7314151073879	20	37,29	598
3625NL-50	7314151073886	20	62,26	598
3625PU-105	7314150170098	4	250,37	597
3625PU-30	7311518276119	12	30,65	597
3625PU-50	7311518276126	6	50,59	597
3625PU-60	7311518276133	6	76,31	597
3625RM-55	7314150120758	50	10,91	598
3625RM-65	7314150120765	40	11,78	598
3625RM-75	7314153019820	30	14,12	598
3625RM-90	7314150120390	20	17,15	598
3625S-28	7314150183906	50	23,50	598
3625S-35	7314150183913	30	31,34	598
3625S-44	7314150183920	18	44,37	598
3625W-22	7314150120406	120	11,01	598
3625W-28	7314150120413	1	15,74	598
3625W-35	7314150120420	1	19,83	598
3625W-44	7314150120437	1	28,94	598
3625W-55	7314150120444	12	55,66	598
3625WL-22	7314150120451	10	4,19	598
3625WL-28	7314150120468	10	4,65	598
3625WL-35	7314150120475	10	5,66	598
3625WL-44	7314150120482	10	6,19	598
3625WL-55	7314150120499	6	8,19	598
3625WLH-22	7314150219025	50	3,39	598
3625WLH-28	7314150218981	50	3,57	598
3625WLH-35	7314150218998	80	3,83	598
3625WLH-44	7314150219001	50	4,48	598
3625WLH-55	7314150219018	16	4,74	598
3625Y-22	7314151074074	6	42,22	597
3625Y-32	7314151074098	6	60,56	597
3625Y-40	7314151074111	6	83,69	597
3625Y-50	7314151074128	6	117,95	597
3625YL-22	7314151074159	20	17,04	597
3625YL-32	7314151074173	20	29,59	597
3625YL-40	7314151074197	20	52,67	597
3625YL-50	7314151074203	20	87,32	597
363-32	7311518295578	1	47,03	268
3640-150-C	7314150180691	25	16,44	604
3640-200-C	7314150180714	25	18,94	604
3640-250-C	7314150180721	20	22,48	604
3640-300-C	7314150180738	25	28,80	604
3643-100	7314151074654	50	17,89	606
3643-120	7314151074678	50	20,14	606
3643-150	7314151074685	50	25,75	606
3644-120	7314151074708	50	15,00	606
3644-125	7314151074722	50	17,70	606
3644-130	7314151074746	50	21,40	606
3644-150	7314151074760	50	23,01	606
3644-165	7314151074777	50	23,72	606
3644-180	7314151074791	50	31,70	606
3644-200	7314151074807	50	35,93	606
3646-115	7314151074937	250	17,89	607
3646-125	7314151074944	250	17,89	607
3646-150	7314151074951	125	17,97	607
3646-165	7314151074968	125	18,14	607
3646-180	7314151074975	50	20,75	607
3646-200	7314151074982	50	24,92	607
3646/6	7314151074999	25	142,82	607



3649-125	7314150472413	50	9,59	604
3654BMS/7	7314150220816	1	99,95	610
3654R	7314151075132	1	158,47	607
3656-125	7314150472352	50	9,59	604
3656-150	7314150472376	50	13,54	604
3656-175	7314150472390	1	9,59	604
3656/10	7314151075279	1	262,02	608
3658A-2	7314151075293	125	18,17	607
3658A-3	7314151075309	125	18,36	607
3658A-4	7314151075316	125	18,36	607
3658A-5	7314151075323	125	18,43	607
3658A-6	7314151075330	125	18,43	607
3658A-8	7314151075347	50	18,43	607
3658A/6	7314151075354	30	135,80	608
3659-0.9	7314151075507	5	12,13	607
3659-1.4	7314151075514	5	12,35	607
3659-1.8	7314151597351	5	12,70	607
3659-2.4	7314151075538	5	13,65	607
3659-2.8	7314151597436	5	14,39	607
3659-3.4	7314151075552	5	14,69	607
3659-3.9	7314151075569	5	13,54	607
3659-6.0	7314151075576	5	14,96	607
3659/8	7314151075583	1	113,78	608
3659/8T	7314151472573	1	108,85	608
3680	7314151075835	1	64,33	370
3681-11	7314150132980	1	31,92	371
3681-16	7314150132997	1	38,32	371
3681-20	7314150133000	1	47,89	371
3683	7314151075866	1	53,27	370
3684-16	7314150133017	1	24,53	370
3684-18	7314150133024	1	33,71	370
3684-24	7314150133031	1	43,75	370
3684-30	7314150133048	1	73,52	370
369-BLADE	7311518016531	20	19,55	561
370-4	7311518296193	1	47,03	268
3717 A	7314150489916	1	27,56	253
3718 A	7314150489930	12	51,18	254
3719 A	7314150489954	12	39,37	254
372-1.1/2	7314150133239	1	113,33	267
372-12	7314150133284	1	1.069,31	267
372-2.1/2	7314150133246	1	209,68	267
372-4	7314150133253	1	267,31	267
372-6	7314150133260	1	459,27	267
372-8	7314150133277	1	621,59	267
3733-2	7314151834371	50	5,05	607
3733-3	7314151834388	50	5,05	607
3733-4	7314151834395	50	4,95	607
3733-5	7314151834401	50	4,95	607
3733-6	7314151834418	50	4,95	607
3733S/5	7314150220809	25	26,81	608
3734-2	7314151834296	50	8,54	607
3734-3	7314151834319	50	8,54	607
3734-4	7314151834326	50	8,54	607
3734-5	7314151834333	50	8,54	607
3734-6	7314151834340	50	8,54	607
3734-8	7314151834357	50	8,73	607
3734BMS/7	7314150220755	1	97,41	610
3734N-10-150	7314150218110	10	7,57	607
3734N-2-150	7314150218042	10	6,14	607
3734N-3-150	7314150218059	10	6,14	607
3734N-4-150	7314150218066	10	6,34	607
3734N-5-150	7314150218073	10	6,34	607
3734N-6-150	7314150218080	10	7,57	607
3734N-7-150	7314150218097	10	7,57	607
3734N-8-150	7314150218103	10	7,57	607
3734N-9-150	7314150218127	10	7,57	607
3734NS/9	7314150218134	10	62,16	608
3734S/6	7314151834470	5	67,22	608
3735-4-120	7314151834265	50	5,32	606
3735-5-120	7314151834272	50	6,56	606
3735-5-150	7314151834289	50	8,73	606
3735N-2-100	7314150217953	10	5,54	606
3735N-4-120	7314150217960	10	6,16	606
3735N-5-120	7314150217977	10	6,96	606
3735N-6-150	7314150217984	10	7,57	606
3735N-8-150	7314150217991	10	7,57	606
3735NS/4	7314150218004	25	27,62	606
3736M-200	7314150220878	30	15,78	605
3736M-250	7314151834142	25	20,74	605
3736M-300	7314151834159	10	27,49	605
3736M-400	7314151834166	10	36,25	605
3736MH-250	7314151834173	10	28,58	605
3736MH-300	7314151834180	10	35,13	605
3736MH-400	7314151834197	5	43,96	605
3736S/6	7314151834463	5	60,37	605
3739-250	7314151834203	25	20,84	605
3739-300	7314151834210	10	27,60	605
3739-400	7314151834227	10	36,45	605
3739H-250	7314151834234	15	28,74	605
3739H-300	7314151834241	10	35,32	605
3739H-400	7314151834258	10	44,18	605
3740-100	7314151834005	50	9,17	604
3740-125	7314151834012	50	11,05	604
3740-150	7314151834029	50	12,63	604
3740-175	7314151834036	25	13,37	604
3740-200	7314151834043	25	14,50	604



3740-250	7314151834050	10	15,26	604
3740-300	7314151834067	10	16,32	604
3745-150	7314151834081	50	13,64	604
3745-175	7314151834098	25	17,43	604
3745-200	7314151834104	20	18,49	604
3745-250	7314151834111	10	26,05	604
3749-125	7314150457915	50	6,85	604
375-8	7311518296209	1	47,03	268
3750	7314151834128	25	18,07	604
3750H	7314151834135	25	26,32	605
3756-125	7314150457892	50	6,85	604
3756-150	7314150457908	50	8,50	604
38-12	7314151831264	5	20,20	331
38-16	7314151831271	5	25,59	331
38-20	7314151831288	2	32,32	331
38-24	7314151831295	1	40,39	331
38-8	7314151831257	5	16,15	331
380-10	7314150133178	1	45,14	267
380-14	7314150133185	1	60,00	267
380-18	7314150133192	1	85,71	267
380-24	7314150133208	1	142,80	267
380-36	7314150133215	1	276,19	267
380-48	7314150133222	1	406,67	267
3802-300-25-1.25-10	7311518111229	10	11,89	19
3802-300-25-1.25-14	7311518111236	10	11,94	19
3802-300-25-1.25-6	7311518143299	10	11,89	19
3802-300-32-1.60-10	7311518111274	10	17,40	19
3802-300-32-1.60-6	7311518111298	10	17,15	19
3802-350-25-1.25-10	7311518111335	10	13,97	19
3802-350-25-1.25-14	7311518111342	10	13,97	19
3802-350-25-1.25-6	7311518111359	10	13,97	19
3802-350-32-1.60-10	7311518111397	10	18,42	19
3802-350-32-1.60-14	7311518111403	10	18,42	19
3802-350-32-1.60-4	7311518111410	10	18,42	19
3802-350-32-1.60-6	7311518111427	10	18,42	19
3802-350-32-1.60-8	7311518140908	10	18,42	19
3802-400-25-1.25-10	7311518111496	10	17,81	19
3802-400-25-1.25-14	7311518111502	10	17,81	19
3802-400-25-1.25-6	7311518111519	10	17,81	19
3802-400-32-1.60-10	7311518111557	10	23,25	19
3802-400-32-1.60-14	7311518111564	10	23,25	19
3802-400-32-1.60-4	7311518111571	10	23,25	19
3802-400-32-1.60-6	7311518111588	10	23,25	19
3802-400-32-1.60-8	7311518111595	10	23,25	19
3802-400-38-2.00-10	7311518111649	10	31,05	19
3802-400-38-2.00-4	7311518111656	10	31,05	19
3802-400-38-2.00-6	7311518111663	10	31,05	19
3802-425-32-1.60-10	7311518111694	10	28,08	19
3802-425-32-1.60-6	7311518111700	10	27,59	19
3802-450-32-1.60-10	7311518111731	10	29,06	19
3802-450-32-1.60-14	7311518111748	10	29,06	19
3802-450-32-1.60-4	7311518111755	10	29,06	19
3802-450-32-1.60-6	7311518111762	10	29,06	19
3802-450-38-2.00-10	7311518111816	10	38,98	19
3802-450-38-2.00-10-KA	7311518111823	10	38,98	19
3802-450-38-2.00-4	7311518111830	10	38,98	19
3802-450-38-2.00-4-KA	7311518111847	10	38,98	19
3802-450-38-2.00-6	7311518111854	10	38,98	19
3802-450-38-2.00-6-KA	7311518111861	10	38,98	19
3802-450-38-2.00-8	7311518111878	10	38,98	19
3802-450-38-2.00-8-KA	7311518111885	10	38,98	19
3802-475-38-2.00-8	7311518113117	10	41,71	19
3802-500-38-2.00-10	7311518111953	10	45,78	19
3802-500-38-2.00-4	7311518111960	10	45,78	19
3802-500-38-2.00-6	7311518111977	10	45,78	19
3802-500-38-2.00-8	7311518113070	10	45,78	19
3802-500-45-2.25-10	7311518111984	10	64,49	19
3802-500-50-2.50-4	7311518112028	10	69,05	19
3802-500-50-2.50-4-KA	7311518112035	10	69,05	19
3802-500-50-2.50-6	7311518112042	10	69,05	19
3802-500-50-2.50-6-KA	7311518112059	10	69,05	19
3802-525-38-2.00-10	7311518112073	10	48,09	19
3802-525-38-2.00-6	7311518112097	10	47,63	19
3802-525-38-2.00-8	7311518112103	10	42,64	19
3802-550-38-2.00-6	7311518112158	10	44,81	19
3802-550-50-2.50-10	7311518112196	10	77,84	19
3802-550-50-2.50-4	7311518112202	10	75,93	19
3802-550-50-2.50-4-KA	7311518112219	10	76,31	19
3802-550-50-2.50-6	7311518112226	10	76,31	19
3802-550-50-2.50-8	7311518112240	5	77,84	19
3802-550-50-2.50-8-KA	7311518113315	10	76,31	19
3802-575-50-2.50-3-KA	7311518112301	10	79,78	19
3802-575-50-2.50-4	7311518112318	10	79,78	19
3802-575-50-2.50-4-KA	7311518112325	10	79,78	19
3802-575-50-2.50-6	7311518112332	10	79,78	19
3802-575-50-2.50-6-KA	7311518112349	10	79,78	19
3802-600-50-2.50-4	7311518112417	10	84,98	19
3802-600-50-2.50-6	7311518112431	10	84,98	19
3802-600-50-2.50-8	7311518112455	10	84,98	19
3802-650-50-2.50-4	7311518112509	5	94,50	19
3802-650-50-2.50-4-KA	7311518112523	5	94,50	19
3802-650-50-2.50-6	7311518112530	5	94,50	19
3802-650-50-2.50-6-KA	7311518112554	5	86,26	19
3802-700-50-2.50-2-KA	7311518112578	5	102,87	19
3802-700-50-2.50-3	7311518112585	5	90,79	19
3802-700-50-2.50-4	7311518112608	5	103,30	19



3802-700-50-2.50-4-KA	7311518112615	5	103,30	19
3802-700-50-2.50-6	7311518112622	5	103,30	19
3802-700-50-2.50-6-KA	7311518112639	5	103,30	19
3802-750-50-2.50-4	7311518112660	5	120,49	19
3802-750-50-2.50-6	7311518112677	5	110,04	19
3806-600-32	7311518018092	10	26,16	557
3809-300-25-1.25-10	7311518113711	10	10,71	18
3809-300-25-1.25-14	7311518113728	10	10,77	18
3809-300-32-1.60-10	7311518113735	10	15,44	18
3809-300-32-1.60-6	7311518113742	10	15,32	18
3809-350-25-1.25-10	7311518113759	10	12,50	18
3809-350-25-1.25-14	7311518113766	10	12,50	18
3809-350-25-1.25-6	7311518113773	10	12,50	18
3809-350-32-1.60-10	7311518113780	10	16,48	18
3809-350-32-1.60-14	7311518113797	10	16,48	18
3809-350-32-1.60-4	7311518113803	10	16,48	18
3809-350-32-1.60-6	7311518113810	10	16,48	18
3809-350-32-1.60-8	7311518113827	10	16,48	18
3809-350-32-2.00-10	7311518113834	10	22,08	18
3809-350-32-2.00-4	7311518113841	10	22,08	18
3809-350-38-2.00-10	7311518113858	10	22,08	18
3809-350-38-2.00-10	7311518113865	10	27,66	18
3809-350-38-2.00-6	7311518113889	10	27,66	18
3809-400-25-1.25-10	7311518178666	10	15,91	18
3809-400-32-1.60-10	7311518113896	10	20,94	18
3809-400-32-1.60-14	7311518113902	10	20,94	18
3809-400-32-1.60-4	7311518113919	10	20,94	18
3809-400-32-1.60-6	7311518113933	10	20,94	18
3809-400-32-1.60-8	7311518113940	10	20,94	18
3809-400-32-2.00-10	7311518113957	10	24,56	18
3809-400-32-2.00-4	7311518113964	10	24,56	18
3809-400-32-2.00-6	7311518113971	10	24,56	18
3809-400-32-2.00-6-KA	7311518158248	10	24,59	19
3809-400-32-2.00-8	7311518114152	10	25,05	18
3809-400-38-2.00-10	7311518113988	10	28,00	18
3809-400-38-2.00-4	7311518113995	10	28,00	18
3809-400-38-2.00-6	7311518114008	10	28,00	18
3809-425-32-1.60-10	7311518114015	10	28,00	18
3809-425-32-1.60-6	7311518197759	10	24,73	18
3809-450-32-1.60-10	7311518114022	10	26,16	18
3809-450-32-1.60-14	7311518114039	10	26,16	18
3809-450-32-1.60-4	7311518114046	10	26,16	18
3809-450-32-1.60-6	7311518114053	10	26,16	18
3809-450-32-2.00-10	7311518114060	10	30,83	18
3809-450-32-2.00-4	7311518114077	10	30,83	18
3809-450-32-2.00-6	7311518114084	10	30,83	18
3809-450-38-2.00-10	7311518114091	10	35,06	18
3809-450-38-2.00-10-KA	7311518114107	10	35,06	19
3809-450-38-2.00-4	7311518114114	10	35,06	18
3809-450-38-2.00-4-KA	7311518114121	10	35,06	19
3809-450-38-2.00-6	7311518114138	10	35,06	18
3809-450-38-2.00-6-KA	7311518114145	10	35,06	18
3809-450-38-2.00-8	7311518114176	10	35,06	18
3809-450-45-2.25-4	7311518114206	10	43,92	18
3809-450-45-2.25-6	7311518114213	10	43,92	18
3809-475-45-2.25-6	7311518114237	10	50,75	18
3809-500-38-2.00-10	7311518114244	10	40,96	18
3809-500-38-2.00-4	7311518114251	10	40,96	18
3809-500-38-2.00-6	7311518114268	10	40,96	18
3809-500-45-2.25-4	7311518114275	10	52,47	18
3809-500-45-2.25-6	7311518114299	10	52,47	18
3809-500-45-2.25-6-KA	7311518114305	10	52,47	19
3809-500-50-2.50-4	7311518114312	10	62,01	18
3809-500-50-2.50-4-KA	7311518114329	10	62,01	19
3809-500-50-2.50-6	7311518114336	10	62,01	18
3809-500-50-2.50-6-KA	7311518114343	10	62,01	19
3809-500-50-2.50-8	7311518114350	10	62,93	18
3809-525-38-2.00-10	7311518114367	10	42,81	18
3809-525-38-2.00-6	7311518114374	10	42,81	18
3809-525-45-2.25-4	7311518114381	10	54,85	18
3809-525-45-2.25-6	7311518114398	10	54,85	18
3809-550-45-2.25-4	7311518114411	10	57,69	18
3809-550-45-2.25-6	7311518114428	10	57,69	18
3809-550-50-2.50-4	7311518114435	10	68,75	18
3809-550-50-2.50-4-KA	7311518114442	10	68,75	19
3809-550-50-2.50-6	7311518114459	10	68,75	18
3809-550-50-2.50-6-KA	7311518114466	10	68,75	19
3809-575-45-2.25-4	7311518114473	10	62,84	18
3809-575-50-2.50-10-KA	7311518114497	10	71,69	18
3809-575-50-2.50-3	7311518114602	10	71,6	

3809-650-50-2.50-6



3809-650-50-2.50-6	7311518114671	5	84,90	18
3809-650-50-2.50-6-KA	7311518114688	5	84,90	19
3809-700-50-2.50-3-KA	7311518114695	5	92,76	19
3809-700-50-2.50-4	7311518114701	5	92,76	18
3809-700-50-2.50-4-KA	7311518114718	5	92,76	19
3809-700-50-2.50-6	7311518114725	5	92,76	18
3809-700-50-2.50-6-KA	7311518114732	5	92,76	19
3809-750-50-2.50-4	7311518114749	5	108,25	18
3809-750-50-2.50-6	7311518234409	5	108,25	18
3815-200-2,0-32-1-03BW	7311518160258	1	82,95	17
3815-200-2,0-32-1-04BW	7311518160241	1	103,69	17
3815-225-2,0-32-1-03BW	7311518160319	1	125,59	17
3815-225-2,0-32-1-04BW	7311518158347	1	125,59	17
3815-225-2,0-32-1-05BW	7311518160302	1	125,59	17
3815-225-2,0-32-1-06C	7311518160296	1	125,59	17
3815-250-2,0-32-1-03BW	7311518160586	1	137,78	17
3815-250-2,0-32-1-04BW	7311518160579	1	137,78	17
3815-250-2,0-32-1-05BW	7311518158354	1	137,78	17
3815-250-2,0-32-1-06C	7311518160562	1	137,78	17
3815-250-2,0-40-2-03BW	7311518160340	1	137,78	18
3815-250-2,0-40-2-04BW	7311518174446	1	137,78	18
3815-250-2,0-40-2-05BW	7311518160333	1	137,78	18
3815-275-2,5-32-1-04BW	7311518160593	1	190,83	17
3815-275-2,5-32-1-05BW	7311518158361	1	190,83	17
3815-275-2,5-32-1-06C	7311518174590	1	190,83	17
3815-275-2,5-32-1-08C	7311518174583	1	190,83	17
3815-275-2,5-40-2-03BW	7311518176433	1	190,83	18
3815-275-2,5-40-2-04BW	7311518160623	1	190,83	18
3815-275-2,5-40-2-05BW	7311518158378	1	190,83	18
3815-275-2,5-40-2-06C	7311518160616	1	190,83	18
3815-275-2,5-40-2-08C	7311518160609	1	190,83	18
3815-300-2,5-32-1-04BW	7311518160630	1	235,28	17
3815-300-2,5-32-1-05BW	7311518158385	1	235,28	17
3815-300-2,5-32-1-05C	7311518174699	1	235,28	17
3815-300-2,5-32-1-06C	7311518174705	1	235,28	17
3815-300-2,5-32-1-08C	7311518174712	1	235,28	17
3815-315-2,5-32-1-04BW	7311518160210	1	283,90	17
3815-315-2,5-32-1-05BW	7311518160203	1	283,90	17
3815-315-2,5-32-1-06C	7311518160197	1	283,90	17
3815-315-2,5-32-1-08C	7311518160401	1	283,90	17
3815-315-2,5-40-2-04BW	7311518160456	1	283,90	18
3815-315-2,5-40-2-05BW	7311518160449	1	283,90	18
3815-315-3,0-40-2-06C	7311518174842	1	302,96	17
3815-350-2,5-32-1-04BW	7311518197605	1	397,76	18
3815-350-2,5-32-1-06C	7311518197612	1	397,76	17
3815-370-3,0-50-4-08C	7311518174989	1	397,76	18
3815-370-3,0-50-4-10C	7311518174996	1	397,76	18
3815-400-3,5-50-4-10C	7311518160494	1	522,87	18
3816-300	7311518015749	50	12,83	558
3818-300-PROG-100	7311518288105	100	2,30	557
3818-300-PROG-5P	7314150265589	10	14,44	557
383-6T	7311518128876	4	19,98	630
3830-102-C	7311518225612	1	34,74	124
3830-102-VIP	7311518042035	4	34,74	124
3830-105-C	7311518225629	1	36,63	124
3830-105-VIP	7311518042042	4	36,63	124
3830-108-C	7311518228521	1	42,82	124
3830-108-VIP	7311518042059	4	42,82	124
3830-111-C	7311518228538	1	49,89	124
3830-111-VIP	7311518042066	4	49,89	124
3830-114-C	7311518225636	1	55,58	124
3830-114-VIP	7311518042073	4	55,58	124
3830-121-C	7311518225643	1	61,89	124
3830-121-VIP	7311518042080	1	61,89	124
3830-127-C	7311518225650	1	67,57	124
3830-127-VIP	7311518042097	1	67,57	124
3830-133-C	7311518228545	1	72,62	124
3830-133-VIP	7311518042103	1	72,62	124
3830-14-C	7311518228347	1	11,87	124
3830-14-VIP	7311518041618	6	11,87	124
3830-140-C	7311518228552	1	77,67	124
3830-140-VIP	7311518042110	1	77,67	124
3830-146-C	7311518228569	1	80,83	124
3830-146-VIP	7311518042127	1	80,83	124
3830-152-C	7311518225667	1	88,41	124
3830-152-VIP	7311518042134	1	88,41	124
3830-16-C	7311518225353	1	11,87	124
3830-16-VIP	7311518041625	6	11,87	124
3830-168	7311518040659	1	114,84	124
3830-17-C	7311518228354	1	11,87	124
3830-17-VIP	7311518041632	6	11,87	124
3830-177-HIGH	7311518101329	1	158,10	124
3830-19-4P	7314150428557	1	17,52	124
3830-19-C	7311518225360	1	11,87	124
3830-19-VIP	7311518041649	6	11,87	124
3830-20-4P	7314150428601	1	18,67	124
3830-20-C	7311518225377	1	11,87	124
3830-20-VIP	7311518041656	6	11,87	124
3830-21-C	7311518228361	1	11,87	124
3830-21-VIP	7311518041663	6	11,87	124
3830-210	7311518040666	1	172,27	124
3830-22-4P	7314150428649	1	30,97	124
3830-22-C	7311518225384	1	11,87	124
3830-22-VIP	7311518041670	6	11,87	124
3830-24-C	7311518228378	1	11,87	124
3830-24-VIP	7311518041687	6	11,87	124



3830-25-4P	7314150428663	1	34,13	124
3830-25-C	7311518225391	1	11,99	124
3830-25-VIP	7311518041694	6	11,99	124
3830-27-4P	7314150428670	1	32,45	124
3830-27-C	7311518225407	1	12,63	124
3830-27-VIP	7311518041700	6	12,63	124
3830-29-4P	7314150428922	1	32,72	124
3830-29-C	7311518225414	1	12,63	124
3830-29-VIP	7311518041717	6	12,63	124
3830-30-4P	7314150433483	1	33,00	124
3830-30-C	7311518225421	1	12,63	124
3830-30-VIP	7311518041724	6	12,63	124
3830-32-4P	7314150428687	1	35,04	124
3830-32-C	7311518225438	1	12,63	124
3830-32-VIP	7311518041731	6	12,63	124
3830-33-C	7311518228385	1	12,63	124
3830-33-VIP	7311518041748	6	12,63	124
3830-35-4P	7314150428700	1	35,82	124
3830-35-C	7311518225445	1	14,28	124
3830-35-VIP	7311518041755	6	14,28	124
3830-37-C	7311518228392	1	14,28	124
3830-37-VIP	7311518041762	6	14,28	124
3830-38-C	7311518225452	1	14,28	124
3830-38-VIP	7311518041779	6	14,28	124
3830-40-C	7311518228408	1	14,28	124
3830-40-VIP	7311518041786	6	14,28	124
3830-41-C	7311518225469	1	14,28	124
3830-41-VIP	7311518041793	6	14,28	124
3830-43-C	7311518228415	1	14,28	124
3830-43-VIP	7311518041809	6	14,28	124
3830-44-C	7311518225476	1	16,30	124
3830-44-VIP	7311518041816	6	16,30	124
3830-46-C	7311518228422	1	16,30	124
3830-46-VIP	7311518041823	6	16,30	124
3830-48-C	7311518225483	1	16,30	124
3830-48-VIP	7311518041830	6	16,30	124
3830-50-C	7311518260873	1	16,30	124
3830-50-VIP	7311518260866	6	16,30	124
3830-51-C	7311518225490	1	16,30	124
3830-51-VIP	7311518041847	6	16,30	124
3830-52-C	7311518228439	1	19,70	124
3830-52-VIP	7311518041854	4	19,70	124
3830-54-C	7311518225506	1	19,70	124
3830-54-VIP	7311518041861	4	19,70	124
3830-55-C	7311518270919	1	19,70	124
3830-55-VIP	7311518270902	4	19,70	124
3830-56-C	7311518228446	1	19,70	124
3830-56-VIP	7311518152703	4	19,70	124
3830-57-C	7311518225513	1	19,70	124
3830-57-VIP	7311518041878	4	19,70	124
3830-59-C	7311518228453	1	19,70	124
3830-59-VIP	7311518041885	4	19,70	124
3830-60-C	7311518225520	1	19,70	124
3830-60-VIP	7311518041892	4	19,70	124
3830-62-VIP	73115182234645	4	21,45	124
3830-64-C	7311518225537	1	21,73	124
3830-64-VIP	7311518041908	4	21,73	124
3830-65-C	7311518228460	1	21,73	124
3830-65-VIP	7311518041915	4	21,73	124
3830-67-C	7311518225544	1	21,73	124
3830-67-VIP	7311518041922	4	21,73	124
3830-68-C	7311518228477	1	21,73	124
3830-68-VIP	7311518196530	4	21,73	124
3830-70-C	7311518225551	1	21,73	124
3830-70-VIP	7311518041939	4	21,73	124
3830-73-C	7311518228484	1	21,73	124
3830-73-VIP	7311518041946	4	21,73	124
3830-76-C	7311518225568	1	24,63	124
3830-76-VIP	7311518041953	4	24,63	124
3830-79-C	7311518228491	1	24,63	124
3830-79-VIP	7311518041960	4	24,63	124
3830-83-C	7311518225575	1	24,63	124
3830-83-VIP	7311518041977	4	24,63	124
3830-86-C	7311518228507	1	24,63	124
3830-86-VIP	7311518041984	4	24,63	124
3830-89-C	7311518225582	1	24,63	124
3830-89-VIP	7311518041991	4	24,63	124
3830-92-C	7311518225599	1	28,54	124
3830-92-VIP	7311518042004	4	28,54	124
3830-95-C	7311518225605	1	30,94	124
3830-95-VIP	7311518042011	4	30,94	124
3830-98-C	7311518228514	1	32,34	124
3830-98-VIP	7311518042028	4	32,34	124
3832-102	7311518558567	4	61,07	131
3832-102-C	7314150474394	1	71,54	132
3832-105	7311518558581	4	65,43	131
3832-108	7311518558604	4	76,72	131
3832-111	7311518558611	4	88,73	131
3832-114	7311518558628	4	98,54	131
3832-114-C	7314150474424	1	115,41	132
3832-121	7311518558642	1	109,46	131
3832-127	7311518558666	1	120,37	131
3832-127-C	7314150474431	1	127,79	132
3832-133	7311518558673	1	130,55	131
3832-14	7			



3832-146	7311518558697	1	148,71	131
3832-152	7311518558703	1	161,80	131
3832-16	7311518557768	6	20,00	131
3832-16-C	7314150474448	1	20,00	132
3832-17	7311518557782	6	20,00	131
3832-19	7311518557805	6	20,00	131
3832-19-C	7314150474455	1	20,00	132
3832-20	7311518557812	6	20,00	131
3832-20-C	7314150474462	1	20,00	132
3832-21	7311518557829	6	20,00	131
3832-22	7311518557843	6	20,00	131
3832-22-C	7314150474479	1	20,00	132
3832-24	7311518557867	6	20,00	131
3832-24-C	7314150479054	1	20,00	132
3832-25	7311518557881	6	21,09	131
3832-25-C	7314150474486	1	21,10	132
3832-27	7311518557904	6	22,54	131
3832-29	7311518557928	6	22,54	131
3832-29-C	7314150474493	1	22,54	132
3832-30	7311518557942	6	22,54	131
3832-30-C	7314150479061	1	22,54	132
3832-32	7311518557966	6	22,54	131
3832-32-C	7314150474509	1	22,54	132
3832-33	7311518557980	6	22,54	131
3832-35	7311518558000	6	25,08	131
3832-35-C	7314150474516	1	25,08	132
3832-37	7311518558024	6	25,08	131
3832-38	7311518558048	6	25,08	131
3832-38-C	7314150474523	1	25,08	132
3832-40	7311518558062	6	25,08	131
3832-41	7311518558086	6	25,08	131
3832-41-C	7314150474530	1	25,08	132
3832-43	7311518558109	6	25,08	131
3832-44	7311518558123	6	29,09	131
3832-44-C	7314150474547	1	29,09	132
3832-46	7311518558147	6	29,09	131
3832-46-C	7314150479078	1	29,09	132
3832-48	7311518558161	6	29,09	131
3832-48-C	7314150474554	1	29,09	132
3832-51	7311518558185	6	29,09	131
3832-51-C	7314150474561	1	29,09	132
3832-52	7311518558208	4	35,28	131
3832-54	7311518558222	4	35,28	131
3832-54-C	7314150474578	1	35,28	132
3832-56	7311518558239	4	35,28	131
3832-57	7311518558246	4	35,28	131
3832-57-C	7314150474585	1	35,28	132
3832-59	7311518558260	4	35,28	131
3832-60	7311518558284	4	35,28	131
3832-60-C	7314150474615	1	35,28	132
3832-64	7311518558307	4	38,90	131
3832-64-C	7314150474622	1	38,91	132
3832-65	7311518558321	4	38,90	131
3832-67	7311518558345	4	38,90	131
3832-68	7311518558352	4	38,90	131
3832-70	7311518558369	4	38,90	131
3832-73	7311518558383	4	38,90	131
3832-73-C	7314150474639	1	38,91	132
3832-76	7311518558406	4	43,28	131
3832-76-C	7314150474646	1	43,28	132
3832-79	7311518558420	4	43,28	131
3832-83	7311518558444	4	43,28	131
3832-83-C	7314150474653	1	43,28	132
3832-86	7311518558468	4	43,28	131
3832-86-C	7314150474660	1	43,28	132
3832-89	7311518558482	4	43,28	131
3832-92	7311518558505	4	50,17	131
3832-92-C	7314150474677	1	50,17	132
3832-95	7311518558529	4	54,91	131
3832-98	7311518558543	4	58,18	131
3832-SET-164-ES	7314150487349	1	383,37	132
3832-SET-84-ES	7314150498932	1	231,75	132
3833-102-C	7314150263899	1	32,10	129
3833-105-C	7314150263905	1	32,40	129
3833-108-C	7314150263912	1	32,54	129
3833-109-C	7314150263929	1	35,44	129
3833-111-C	7314150263936	1	32,78	129
3833-114-C	7314150263943	1	35,52	129
3833-121-C	7314150263950	1	35,96	129
3833-127-C	7314150263967	1	37,91	129
3833-133-C	7314150401581	1	38,82	129
3833-140-C	7314150263974	1	39,44	129
3833-152-C	7314150263981	1	42,41	129
3833-159-C	7314150263998	1	48,61	129
3833-168	7314150413546	1	54,35	129
3833-177	7314150413539	1	58,23	129
3833-19-C	7314150263561	1	13,22	129
3833-20-C	7314150263578	1	13,06	129
3833-210	7314150413522	1	67,54	129
3833-22-C	7314150263585	1	13,19	129
3833-225	7314150413515	1	70,98	129
3833-25-C	7314150263592	1	13,61	129
3833-27-C	7314150263608	1	14,20	129
3833-29-C	7314150263615	1	15,01	129
3833-30-C	7314150263622	1	14,83	129
3833-32-C	7314150263639	1	15,12	129



3833-35-C	7314150263646	1	16,97	129
3833-38-C	7314150263653	1	16,97	129
3833-40-C	7314150263660	1	17,27	129
3833-41-C	7314150263677	1	17,27	129
3833-44-C	7314150263684	1	20,31	129
3833-48-C	7314150263691	1	20,31	129
3833-51-C	7314150263707	1	20,81	129
3833-54-C	7314150263714	1	22,54	129
3833-56-C	7314150314676	1	23,48	129
3833-57-C	7314150263721	1	23,48	129
3833-60-C	7314150263738	1	23,48	129
3833-62-C	7314150314683	1	23,48	129
3833-64-C	7314150263745	1	23,61	129
3833-65-C	7314150263752	1	23,61	129
3833-67-C	7314150263769	1	23,61	129
3833-68-C	7314150263776	1	23,86	129
3833-70-C	7314150263783	1	24,05	129
3833-71-C	7314150314690	1	24,05	129
3833-73-C	7314150263790	1	24,05	129
3833-74-C	7314150314706	1	24,05	129
3833-76-C	7314150263806	1	24,94	129
3833-77-C	7314150263813	1	27,38	129
3833-78-C	7314150314713	1	27,38	129
3833-79-C	7314150263820	1	27,38	129
3833-83-C	7314150263837	1	27,91	129
3833-86-C	7314150263844	1	28,11	129
3833-89-C	7314150263851	1	28,24	129
3833-92-C	7314150263868	1	29,05	129
3833-95-C	7314150263875	1	29,88	129
3833-98-C	7314150263882	1	30,39	129
3833-PROMO-42	7314150464951	1	136,04	129
3833-SET-101	7314150315383	1	311,52	129
3833-SET-201	7314150315406	1	353,86	129
3833-SET-202	7314150315420	1	348,92	129
3833-SET-203	7314150315444	1	348,92	130
3833-SET-204	7314150315468	1	314,44	130
3833-SET-205	7314150330874	1	263,46	130
3833-SET-207	7314150330898	1	353,28	130
3833-SET-208	7314150330904	1	360,52	130
3833-SET-301	7314150315376	1	334,19	130
3833-SET-302	7314150315390	1	218,39	131
3833-SET-303	7314150315413	1	280,43	131
3833-SET-304	7314150315437	1	347,22	131
3834-ADP	7311518454425	1	6,42	134
3834-ARBR-11152	7311518015596	1	24,73	133
3834-ARBR-11152-C	7311518225698	1	25,98	133
3834-ARBR-11152QC	7311518167967	1	21,09	133
3834-ARBR-11152QC-C	7311518225711	1	22,16	133
3834-ARBR-1130	7311518015572	4	13,63	133
3834-ARBR-1130-C	7311518228583	1	14,31	133
3834-ARBR-16152	7311518015602	1	24,73	133
3834-ARBR-16152QC	7311518453152	1	23,11	133
3834-ARBR-630	7311518015558	1	11,81	133
3834-ARBR-630-C	7311518228576	1	12,39	133
3834-ARBR-730	7311518167974	1	9,44	133
3834-ARBR-730-C	7311518225674	1	9,93	133
3834-ARBR-9100	7311518015589	1	24,73	133
3834-ARBR-9100-C	7311518228590	1	25,98	133
3834-ARBR-9100EL	7314150265077	1	42,59	132
3834-ARBR-9100ESM	7314150390458	1	43,25	132
3834-ARBR-9100QC	7311518249830	1	21,09	133
3834-ARBR-9100QC-C	7311518225704	1	22,38	133
3834-ARBR-930	7311518015565	1	11,81	133
3834-ARBR-930-C	7311518225681	1	12,39	133
3834-ARBR-930EL	7314150265053	1	41,86	132
3834-ARBR-930ESM	7314150390465	1	41,26	132
3834-ARBR-SD152QC	7311518203825	1	26,19	133
3834-ARBR-SD30	7311518203818	1	14,54	133
3834-CP-20/25	7314150312092	1	62,88	124
3834-DRL	7311518234638	1	5,65	133
3834-DRL-CT	7311518953201	1	16,38	133
3834-DRL-EL	7314150265114	1	9,40	132
3834-DRL-ES	7314150265091	1	9,01	133
3834-DRL-HSS-ES	7314150339396	1	15,88	133
3834-DRL-L	7314150265138	1	9,14	133
3834-ES	7311518454418	1	2,14	133
3834-EXT-1	7311518040673	1	20,80	133
3834-EXT-2	7311518168070	1	20,80	133
3834-M6X29-SET	7314150383450	1	2,67	134
3834-M8X10-SET	7314150383429	1	1,88	134
3834-M8X5-SET	7314150383443	1	1,67	134
3834-M8X6-SET	7314150383436	1	1,77	134
3834-PROMO-122	7314150432059	1	110,00	125
3834-PROMO-122-76	7314150459193	1	120,08	125
3834-PROMO-82	7314150432042	1	91,19	125
3834-SET-103	7314150134908	1	144,11	128
3834-SET-152	7314150255658	1	256,76	128
3834-SET-42	7311518241988	1	149,90	125
3834-SET-53	7314150127153	1	218,37	125
3834-SET-61	7311518266431	1	183,16	126
3834-SET-62	7311518228040	1	122,46	126
3834-SET-62-16/50	7311518258887	1	117,04	126
3834-SET-65-16/51	7311518159900	1	136,54	126
3834-SET-65-22/64	7311518159917	1	151,95	126
3834-SET-72	7311518044992	1	163,24	126
3834-SET-72-35/83	7314150444229	1	125,18	125



3834-SET-73



3834-SET-73	7311518254339	1	202,95	127
3834-SET-73-22/68	7314150134809	1	151,43	127
3834-SET-77	7314150235919	1	200,30	127
3834-SET-84-ES	7314150470587	1	122,61	127
3834-SET-86	7311518224295	1	268,80	127
3834-SET-87	7311518181772	1	187,87	127
3834-SET-92	7311518044985	1	187,88	128
3834-SET-93	7314150414741	1	163,11	128
3834-SET-94	7311518166458	1	174,23	128
3834-SET-95	7311518159894	1	184,21	128
3834-UPSIZO	7314150344567	1	4,43	133
3835-SET-64	7314150423309	1	252,92	132
3835-SET-711	7314150465835	1	265,55	132
384-5T	7311518159795	4	18,81	630
384-6T	7311518002039	4	18,81	630
3845-18-10P	7311518101602	1	40,61	135
3845-24-10P	7311518101619	1	40,61	135
3845-32-10P	7311518101626	1	40,61	135
385-6T	7311518002053	4	19,98	630
3851-10-0.6-10/14	7311518182717	1	8,98	12
3851-10-0.6-H-4	7311518282776	1	8,98	12
3851-10-0.6-H-6	7311518282806	1	8,98	12
3851-10-0.6-HA-4	7314150139309	1	8,98	12
3851-10-0.9-10/14	7311518182823	1	8,98	12
3851-10-0.9-H-4	7311518282851	1	8,98	12
3851-10-0.9-H-6	7311518282868	1	8,98	12
3851-10-0.9-R-14	7314150312399	1	8,98	12
3851-13-0.5-10/14	7311518282813	1	8,98	12
3851-13-0.5-14/18	7311518282790	1	8,98	12
3851-13-0.5-H-4	7311518292072	1	8,98	12
3851-13-0.5-R-10	7311518331306	1	8,98	12
3851-13-0.5-R-14	7311518331320	1	8,98	12
3851-13-0.5-R-18	7311518331344	1	8,98	12
3851-13-0.5-R-24	7311518282820	1	8,98	12
3851-13-0.6-10/14	7311518183271	1	8,98	12
3851-13-0.6-5/8	7311518183233	1	8,98	12
3851-13-0.6-6/10	7311518183240	1	8,98	12
3851-13-0.6-8/12	7311518185572	1	8,98	12
3851-13-0.6-H-3	7311518282769	1	8,98	12
3851-13-0.6-H-4	7311518282745	1	8,98	12
3851-13-0.6-H-6	7311518282738	1	8,98	12
3851-13-0.6-HA-4	7311518282752	1	8,98	12
3851-13-0.6-HA-6	7311518282561	1	8,98	12
3851-13-0.6-R-10	7311518183110	1	8,98	12
3851-13-0.6-R-14	7311518183158	1	8,98	12
3851-13-0.6-R-18	7311518183196	1	8,98	12
3851-13-0.9-10/14	7311518183868	1	8,98	12
3851-13-0.9-6/10	7311518183585	1	8,98	12
3851-13-0.9-H-3	7311518282936	1	8,98	12
3851-13-0.9-H-4	7311518282943	1	8,98	12
3851-13-0.9-H-6	7311518286125	1	8,98	12
3851-13-0.9-HA-4	7311518281052	1	8,98	12
3851-13-0.9-R-14	7311518182359	1	8,98	12
3851-13-0.9-R-6	7311518183301	1	8,98	12
3851-20-0.9-10/14	7311518282585	1	9,15	12
3851-20-0.9-4/6	7311518183905	1	9,15	12
3851-20-0.9-5/8	7311518183929	1	9,15	12
3851-20-0.9-6/10	7311518183936	1	9,15	12
3851-20-0.9-8/12	7311518282578	1	9,15	12
3851-20-0.9-H-3	7314150398515	1	9,15	12
3851-20-0.9-H-4	7314150398294	1	9,15	12
3851-20-0.9-HA-3	7311518282646	1	9,15	12
3851-20-0.9-HA-4	7311518282653	1	9,15	12
3851-20-0.9-R-18	7311518332587	1	9,15	12
3851-27-0.9-10/14	7311518165475	1	9,30	13
3851-27-0.9-2/3	7311518126377	1	9,30	13
3851-27-0.9-3/4	7311518126384	1	9,30	13
3851-27-0.9-4/6	7311518126391	1	9,30	13
3851-27-0.9-5/8	7311518126407	1	9,30	13
3851-27-0.9-6/10	7311518126414	1	9,30	13
3851-27-0.9-8/12	7311518160692	1	9,30	13
3851-27-0.9-HA-3	7311518282684	1	9,30	12
3851-27-0.9-HA-4	7314150398317	1	9,30	12
3851-27-0.9-P-3	7311518157135	1	9,30	12
3851-27-0.9-P-4	7311518157661	1	9,30	12
3851-27-0.9-R-6	7311518126353	1	9,30	12
3851-34-1.1-2/3	7311518126476	1	13,67	13
3851-34-1.1-3/4	7311518126483	1	13,67	13
3851-34-1.1-4/6	7311518126490	1	13,67	13
3851-34-1.1-5/8	7311518126506	1	13,67	13
3851-34-1.1-6/10	7311518165505	1	13,67	13
3851-34-1.1-P-2	7311518157715	1	13,67	12
3851-34-1.1-P-3	7311518157753	1	13,67	12
3851-41-1.3-1.4/2	7311518211837	1	17,71	13
3851-41-1.3-2/3	7311518126568	1	17,71	13
3851-41-1.3-3/4	7311518126575	1	17,71	13
3851-41-1.3-4/6	7311518126582	1	17,71	13
3851-41-1.3-5/8	7311518262488	1	17,71	13
3851-54-1.3-1.4/2	7314150459360	1	20,23	13
3851-54-1.3-2/3	7311518163716	1	20,25	13
3851-54-1.3-3/4	7311518163723	1	22,73	13
3851-54-1.3-4/6	7311518168025	1	20,25	13
3851-54-1.6-1.4/2	7311518211431	1	20,25	13
3851-54-1.6-1/1.4	7311518188542	1	20,25	13
3851-54-1.6-2/3	7311518126636	1	20,25	13
3851-54-1.6-3/4	7311518126643	1	20,25	13



3851-54-1.6-4/6	7314150398539	1	20,25	13
3851-54-1.6-P-1.25	7311518158026	1	20,25	13
3851-6-0.6-10/14	7311518180652	1	8,66	12
3851-6-0.6-H-6	7311518282707	1	8,66	12
3851-6-0.9-10/14	7311518180768	1	8,66	12
3851-6-0.9-H-6	7311518282714	1	8,66	12
3851-67-1.6-7/1	7311518200909	1	35,08	13
3851-67-1.6-1.4/2	7314150273317	1	35,08	13
3851-67-1.6-1/1.4	7311518178840	1	35,08	13
3851-67-1.6-2/3	7311518335243	1	35,08	13
3851-67-1.6-3/4	7311518328597	1	35,08	13
3851-67-1.6-4/6	7311518194963	1	35,08	13
3851-80-1.6-7/1	7311518255367	1	52,69	13
3851-80-1.6-1.4/2	7311518255350	1	52,69	13
3851-80-1.6-1/1.4	7311518197377	1	52,69	13
3852-27-0.9-INS-3	7311518358204	1	13,39	17
3852-34-1.1-INS-3	7311518359188	1	14,42	17
3853-20-0.9-5/7-VS	7311518331689	1	10,04	14
3853-20-0.9-8/11-VS	7311518331702	1	10,04	14
3853-27-0.9-3/4	7311518285395	1	10,43	14
3853-27-0.9-4/6	7311518183998	1	10,43	14
3853-27-0.9-5/7-VS	7311518331115	1	10,43	14
3853-27-0.9-5/8	7311518202118	1	10,43	14
3853-27-0.9-8/11-VS	7311518331122	1	10,43	14
3853-34-1.1-2/3	7311518282875	1	12,91	14
3853-34-1.1-3/4	7311518184094	1	12,91	14
3853-34-1.1-4/6	7311518184087	1	12,91	14
3853-34-1.1-5/7-VS	7311518331726	1	12,91	14
3853-34-1.1-5/8	7311518202149	1	12,91	14
3853-34-1.1-8/11-VS	7311518331719	1	12,91	14
3853-41-1.3-2/3	7311518282882	1	20,00	14
3853-41-1.3-2/3-W	7314150370115	1	20,00	14
3853-41-1.3-2/3-WS	7314150415113	1	51,85	14
3853-41-1.3-3/4	7311518185770	1	20,00	14
3853-41-1.3-3/4-W	7311518338053	1	20,00	14
3853-41-1.3-3/4-WS	7314150415120	1	48,87	14
3853-41-1.3-4/6	7311518184100	1	20,00	14
3853-41-1.3-5/7-VS	7311518331733	1	20,00	14
3853-41-1.3-5/8	7311518202286	1	20,00	14
3853-54-1.3-3/4	7311518184124	1	24,56	14
3853-54-1.3-3/4-W	7314150352876	1	24,56	14
3853-54-1.3-5/8	7311518197568	1	24,56	14
3853-54-1.6-2/3	7311518282899	1	24,56	14
3853-54-1.6-2/3-W	7311518338077	1	24,56	14
3853-54-1.6-2/3-WS	7314150415151	1	57,14	14
3853-54-1.6-3/4	7311518216757	1	24,56	14
3853-54-1.6-3/4-W	7311518338091	1	24,56	14
3853-54-1.6-3/4-WS	7314150415168	1	53,47	14
3853-54-1.6-4/6	7311518222055	1	24,56	14
3853-67-1.6-2/3	7311518282905	1	34,90	14
3853-67-1.6-2/3-W	7311518338114	1	34,90	14
3853-67-1.6-2/3-WS	7314150415175	1	63,70	14
3853-67-1.6-3/4	7311518282912	1	34,90	14
3853-67-1.6-3/4-W	7311518338138	1	34,90	14
3853-67-1.6-3/4-WS	7314150415182	1	62,01	14
3853-67-1.6-5/8-W	7311518338152	1	34,90	14
3854-27-0.9-PHX-2/3	7314150440603	1	10,45	13
3854-27-0.9-PHX-3/4	7314150440610	1	10,45	13
3854-27-0.9-PHX-4/6	7314150440627	1	10,45	13
3854-27-0.9-PQ-3/4	7314150137480	1	14,57	13
3854-27-0.9-PQ-4/6	7314150197828	1	14,57	13
3854-34-1.1-PHX-1.4/2	7314150440634	1	14,63	13
3854-34-1.1-PHX-2/3	7314150440641	1	14,63	13
3854-34-1.1-PHX-3/4	7314150440658	1	14,63	13
3854-34-1.1-PHX-4/6	7314150440665	1	14,63	13
3854-34-1.1-PQ-2/3	7311518287276	1	16,59	13
3854-34-1.1-PQ-3/4	7314150135813	1	16,59	13
3854-34-1.1-PQ-4/6	7314150197835	1	16,59	13
3854-41-1.3-PHX-1.4/2	7314150440672	1	18,95	13
3854-41-1.3-PHX-2/3	7314150440689	1	18,95	13
3854-41-1.3-PHX-3/4	7314150440696	1	18,95	13
3854-41-1.3-PHX-4/6	7314150440702	1	18,95	13
3854-41-1.3-PQ-1.4/2	7314150129355	1	19,75	13
3854-41-1.3-PQ-2/3	7311518280604	1	19,75	13
3854-41-1.3-PQ-3/4	7311518282950	1	19,75	13
3854-41-1.3-PQ-4/6	7314150197842	1	19,75	13
3854-54-1.3-PHX-1.4/2	7314150440719	1	26,39	13
3854-54-1.3-PHX-2/3	7314150440730	1	26,39	13
3854-54-1.3-PHX-3/4	7314150440740	1	26,39	13
3854-54-1.6-PHX-7/1	7314150440757	1	29,89	13
3854-54-1.6-PHX-1.4/2	7314150440771	1	29,89	13
3854-54-1.6-PHX-1/1.4	7314150440764	1	29,89	13
3854-54-1.6-PHX-2/3	7314150440788	1	29,89	13
3854-54-1.6-PHX-3/4	7314150440795	1	29,89	13
3854-54-1.6-PQ-9/1.2	7314150133857	1	30,14	13
3854-54-1.6-PQ-1.4/2	7314150127092	1	30,14	13
3854-54-1.6-PQ-2/3	7311518265137	1	30,14	13
3854-54-1.6-PQ-3/4	7311518282929	1	30,14	13
3854-54-1.6-PQ-4/6				

			€	
3854-80-1.6-PHX-7/1	7314150440849	1	56,38	13
3854-80-1.6-PHX-1.4/2	7314150440863	1	56,38	13
3854-80-1.6-PHX-1/1.4	7314150440856	1	56,38	13
3854-80-1.6-PQ-9/1.2	7314150133895	1	57,86	13
3854-80-1.6-PQ-1.4/2	7314150215966	1	56,38	13
3857-13-0.6-EZ-L	7311518264789	1	9,81	12
3857-13-0.6-EZ-M	7311518264772	1	9,81	12
3857-13-0.6-EZ-M-3P1140	7314150321100	1	27,79	143
3857-13-0.6-EZ-M-3P690	7314150325641	1	27,79	143
3857-13-0.6-EZ-M-3P730	7314150325658	1	27,79	143
3857-13-0.6-EZ-M-3P835	7314150325665	1	27,79	143
3857-13-0.6-EZ-M-3P900	7314150321094	1	27,79	143
3857-13-0.6-EZ-S	7311518264765	1	9,81	12
3857-13-0.6-EZ-S-3P1140	7314150345731	1	27,79	143
3857-13-0.6-EZ-S-3P690	7314150345694	1	27,79	143
3857-13-0.6-EZ-S-3P730	7314150345700	1	27,79	143
3857-13-0.6-EZ-S-3P835	7314150345717	1	27,79	143
3857-13-0.6-EZ-S-3P900	7314150345724	1	27,79	143
3857-20-0.9-EZ-L	7311518264819	1	10,91	12
3857-20-0.9-EZ-M	7311518264802	1	10,91	12
3857-20-0.9-EZ-S	7311518264796	1	10,91	12
3857-27-0.9-EZ-L	7311518264840	1	12,43	12
3857-27-0.9-EZ-M	7311518264833	1	12,43	12
3857-27-0.9-EZ-S	7311518264826	1	12,43	12
3857-34-1.1-EZ-L	7311518264871	1	15,26	12
3857-34-1.1-EZ-M	7311518264864	1	15,26	12
3857-34-1.1-EZ-S	7311518264857	1	15,26	12
3858-34-1.1-PHX-1.4/2	7314150441198	1	15,50	14
3858-34-1.1-PHX-2/3	7314150441204	1	15,50	14
3858-34-1.1-PHX-3/4	7314150441211	1	15,50	14
3858-41-1.3-PHX-1.4/2	7314150441013	1	20,75	14
3858-41-1.3-PHX-2/3	7314150441020	1	20,75	14
3858-41-1.3-PHX-3/4	7314150441037	1	20,75	14
3858-41-1.3-PQ-1.4/2	7314150395583	1	25,63	14
3858-41-1.3-PQ-2/3	7314150395590	1	25,63	14
3858-41-1.3-PQ-3/4	7314150395606	1	25,63	14
3858-54-1.3-PHX-1.4/2	7314150441068	1	26,85	14
3858-54-1.3-PHX-2/3	7314150441044	1	26,85	14
3858-54-1.3-PHX-3/4	7314150441051	1	26,85	14
3858-54-1.6-PHX-7/1	7314150441075	1	26,85	14
3858-54-1.6-PHX-1.4/2	7314150441099	1	26,85	14
3858-54-1.6-PHX-1/1.4	7314150441082	1	26,85	14
3858-54-1.6-PHX-2/3	7314150441105	1	26,85	14
3858-54-1.6-PHX-3/4	7314150441112	1	26,85	14
3858-54-1.6-PQ-9/1.2	7314150395613	1	39,06	14
3858-54-1.6-PQ-1.4/2	7314150395620	1	39,06	14
3858-54-1.6-PQ-2/3	7314150395637	1	39,06	14
3858-67-1.6-PHX-7/1	7314150441129	1	36,62	14
3858-67-1.6-PHX-1.4/2	7314150441143	1	36,62	14
3858-67-1.6-PHX-1/1.4	7314150441136	1	36,62	14
3858-67-1.6-PHX-2/3	7314150441150	1	36,62	14
3858-67-1.6-PQ-9/1.2	7314150395644	1	51,26	14
3858-67-1.6-PQ-1.4/2	7314150395651	1	51,26	14
3858-80-1.6-PHX-7/1	7314150441167	1	43,21	14
3858-80-1.6-PHX-1.4/2	7314150441181	1	43,21	14
3858-80-1.6-PHX-1/1.4	7314150441174	1	43,21	14
3858-80-1.6-PQ-9/1.2	7314150395668	1	73,24	14
3859-27-0.9-EZX-3/4	7314150517558	1	32,14	15
3859-27-0.9-EZX-4/6	7314150517565	1	42,02	15
3859-34-1.1-EZX-2/3	7314150517572	1	31,72	15
3859-34-1.1-EZX-3/4	7314150517589	1	40,38	15
3859-34-1.1-EZX-4/6	7314150517596	1	43,67	15
3859-41-1.3-EZX-1.4/2	7314150517602	1	30,39	15
3859-41-1.3-EZX-2/3	7314150517619	1	34,30	15
3859-41-1.3-EZX-3/4	7314150517626	1	44,19	15
3859-41-1.3-EZX-4/6	7314150517633	1	46,25	15
3859-54-1.6-EZX-1.4/2	7314150517640	1	43,16	15
3859-54-1.6-EZX-1/1.25	7314150517657	1	39,24	15
3859-54-1.6-EZX-2/3	7314150517664	1	44,70	15
3859-54-1.6-EZX-3/4	7314150517671	1	48,00	15
3859-54-1.6-EZX-4/6	7314150517688	1	56,75	15
3859-67-1.6-EZX-7/1	7314150517695	1	39,45	15
3859-67-1.6-EZX-1.4/2	7314150517701	1	46,66	15
3859-67-1.6-EZX-1/1.25	7314150517718	1	42,75	15
3859-67-1.6-EZX-2/3	7314150517725	1	57,17	15
3859-80-1.6-EZX-7/1	7314150517732	1	41,51	15
3859-80-1.6-EZX-1.4/2	7314150517749	1	49,23	15
3859-80-1.6-EZX-1/1.25	7314150517756	1	77,25	15
386-6T	7311518152017	4	21,15	630
3860-100-1.1-TMC-1.4/2	7314150336968	1	116,93	16
3860-27-0.9-TC-D-3	7314150413010	1	96,46	16
3860-27-0.9-TC-D-3/4	7314150413027	1	91,44	16
3860-27-0.9-TC-Z-3/4	7314150263493	1	89,46	16
3860-34-1.1-TC-D-2/3	7314150413034	1	70,73	16
3860-34-1.1-TC-D-3/4	7314150413041	1	100,96	16
3860-34-1.1-TC-D-3/4-W	7314150413058	1	100,96	16
3860-34-1.1-TC-Z-2/3	7311518330880	1	70,76	16
3860-34-1.1-TC-Z-3/4	7311518330897	1	100,95	16
3860-41-1.3-TC-D-1.4/2	7314150413065	1	63,92	16
3860-41-1.3-TC-D-1.9/2.1	7314150413072	1	68,50	16
3860-41-1.3-TC-D-2/3	7314150413089	1	71,35	16
3860-41-1.3-TC-D-3/4	7314150413096	1	106,61	16
3860-41-1.3-TC-Z-2/3	7311518330903	1	69,66	16
3860-41-1.3-TC-Z-3/4	7311518330910	1	106,61	16
3860-41-1.3-TMC-1.4/2	7314150129379	1	97,11	16
3860-41-1.3-TMC-2/3	7311518330224	1	113,62	16

			€	
3860-54-1.3-TMC-1.4/2	7314150288748	1	114,97	16
3860-54-1.3-TMC-2/3	7311518335267	1	133,05	16
3860-54-1.6-TC-D-1.4/2	7314150413119	1	81,39	16
3860-54-1.6-TC-D-1.9/2.1	7314150413133	1	66,41	16
3860-54-1.6-TC-D-2/3	7314150413140	1	97,71	16
3860-54-1.6-TC-D-3/4	7314150413157	1	135,68	16
3860-54-1.6-TMC-7/1	7314150263431	1	90,00	16
3860-54-1.6-TMC-1.4/2	7314150137978	1	106,82	16
3860-54-1.6-TMC-1.4/2S	7314150395316	1	118,67	17
3860-54-1.6-TMC-1/1.25	7314150154340	1	114,11	16
3860-54-1.6-TMC-1/1.25S	7314150395309	1	115,28	17
3860-54-1.6-TMC-2/3	7314150189366	1	146,66	16
3860-54-1.6-TMC-2/3S	7314150395323	1	129,97	17
3860-67-1.6-TC-D-1.4/2	7314150413164	1	87,03	16
3860-67-1.6-TC-D-1/1.25	7314150413171	1	61,43	16
3860-67-1.6-TMC-1.4/2	7314150137985	1	121,39	16
3860-67-1.6-TMC-1.4/2S	7314150395347	1	129,97	17
3860-67-1.6-TMC-1/1.25	7314150154364	1	126,24	16
3860-67-1.6-TMC-1/1.25S	7314150395330	1	124,32	17
3860-67-1.6-TMC-2/3	7314150189359	1	149,72	16
3860-80-1.1-TMC-1.4/2	7314150382767	1	113,27	16
3860-80-1.6-TC-D-5/0.8	7314150413188	1	93,86	16
3860-80-1.6-TMC-7/1	7314150154371	1	135,96	16
3860-80-1.6-TMC-1.4/2	7314150182992	1	149,31	16
3860-80-1.6-TMC-1/1.25	7314150182336	1	142,62	16
3860-80-1.6-TMC-2/3	7314150215959	1	151,11	16
3861-20-0.6-H-4	7311518331351	1	2,88	17
3861-27-0.9-H-1.33	7311518329716	1	3,83	17
3861-34-0.9-H-1.15	7311518258894	1	8,72	17
3861-34-1.1-H-1.15	7311518258900	1	8,72	17
3861-41-1.1-H-1.15	7314150129294	1	11,57	17
3861-54-1.1-H-1.15	7314150129270	1	13,08	17
3862-33-0.9-H-1.15	7314150320325	1	14,12	17
3862-33-1.1-H-1.15	7311518331269	1	14,12	17
3862-40-1.1-H-1.15	7311518331283	1	15,09	17
3868-27-0.9-TSS-3/4	7314150447633	1	87,49	15
3868-27-0.9-TSX-3/4	7311518329693	1	87,49	15
3868-34-1.1-TSS-2/3	7311518329266	1	71,21	15
3868-34-1.1-TSS-3/4	7314150447640	1	8,81	15
3868-34-1.1-TSX-2	7311518203016	1	57,33	15
3868-34-1.1-TSX-2/3	7311518255343	1	69,82	15
3868-34-1.1-TSX-3/4	7311518232375	1	86,09	15
3868-41-1.3-TSS-1.4/2	7311518243142	1	77,62	15
3868-41-1.3-TSS-2/3	7311518270643	1	76,80	15
3868-41-1.3-TSX-1.4/2	7311518214210	1	70,50	15
3868-41-1.3-TSX-1.6	7311518203092	1	61,27	15
3868-41-1.3-TSX-2	7311518203085	1	60,20	15
3868-41-1.3-TSX-2/3	7311518232382	1	74,87	15
3868-41-1.3-TSX-3/4	7311518232399	1	92,13	15
3868-54-1.3-TSX-1.4/2	7311518214876	1	91,48	15
3868-54-1.3-TSX-2/3	7314150416394	1	93,01	15
3868-54-1.6-TSS-1.4/2	7311518243166	1	111,95	15
3868-54-1.6-TSS-1/1.25	7311518243173	1	113,99	15
3868-54-1.6-TSS-2/3	7311518280383	1	118,10	15
3868-54-1.6-TSX-1.4/2	7311518214869	1	101,86	15
3868-54-1.6-TSX-1.6	7311518203108	1	88,57	15
3868-54-1.6-TSX-1/1.25	7311518213114	1	93,16	15
3868-54-1.6-TSX-2/3	7311518232405	1	93,28	15
3868-54-1.6-TSX-3/4	7311518270360	1	93,28	15
3868-67-1.6-TSS-7/1	7311518274115	1	122,43	15
3868-67-1.6-TSS-1.4/2	7311518243197	1	130,30	15
3868-67-1.6-TSS-1/1.25	7311518243180	1	130,30	15
3868-67-1.6-TSS-2/3	7311518328825	1	130,30	15
3868-67-1.6-TSX-7/1	7311518212865	1	122,43	15
3868-67-1.6-TSX-1.4/2	7311518265496	1	130,30	15
3868-67-1.6-TSX-1/1.25	7311518213084	1	127,43	15
3868-67-1.6-TSX-2/3	7314150203536	1	130,30	15
3868-80-1.1-TSX-3/4	7311518330200	1	205,05	15
3868-80-1.6-TSS-7/1	7314150216253	1	130,30	15
3868-80-1.6-TSS-1.4/2	7314150203529	1	156,23	15
3868-80-1.6-TSS-2/3	7314150398553	1	180,64	15
3868-80-1.6-TSX-7/1	7311518212872	1	130,30	15
3868-80-1.6-TSX-1.4/2	7314150342167	1	129,40	15
3868-80-1.6-TSX-1/1.25	7314150277278	1	139,15	15
3868-80-1.6-TSX-2/3	7314150203543	1	180,64	15
3869-13-0.9-TS-3	7311518200589	1	53,99	15
3869-20-0.9-TS-3	7311518177300	1	55,83	15
3869-20-0.9-TS-4	7311518197742	1	81,45	15
3869-27-0.9-TS-3	7311518177348	1	55,83	15
3869-27-0.9-TS-4	7311518182595	1	81,45	15
3869-34-1.1-TS-2	73141			

3875-GLOVE



3875-GLOVE	7314150353330	5	15,87	490
3875-HB10	7314150349777	1	8,88	473
3875-HB100	7314150289783	1	184,46	474
3875-HB30	7314150187720	1	91,26	474
3875-HB60	7314150187713	6	114,12	474
3875-LY1	7314150191253	8	39,25	472
3875-LY10	7314150315062	1	68,32	473
3875-LY2	7314150191260	8	39,25	472
3875-LY3	7314150191284	8	39,25	472
3875-LY4	7314150262878	8	40,77	472
3875-LY60	7314150436521	1	19,82	472
3875-LY70	7314150442751	1	24,87	472
3875-LY8	7314150309689	1	57,38	473
3875-MHP6	7314150187812	1	90,80	474
3875-QL1	7314150191307	8	15,01	472
3875-QRL1	7314150194797	1	19,56	472
3875-RL1	7314150194780	1	68,07	472
3875-RL2	7314150312948	1	68,32	472
3875-SB70	7314150326839	1	252,78	474
3875-SL1	7314150220106	1	0,68	473
3875-WL1	7314150191291	8	25,62	472
3881-100-1.6-THS-7/1	7311518329617	1	75,80	16
3881-34-1.1-THQ-2/3	7311518265793	1	80,12	16
3881-41-1.3-THQ-1.4/2	7314150129447	1	81,17	16
3881-41-1.3-THQ-2/3	7314150129454	1	86,09	16
3881-41-1.3-THS-1.4/2	7311518273712	1	89,27	16
3881-54-1.6-THQ-1.4/2	7314150128860	1	107,24	16
3881-54-1.6-THQ-1/1.25	7314150342181	1	107,37	16
3881-54-1.6-THQ-2/3	7314150138739	1	107,26	16
3881-54-1.6-THS-1.4/2	7314150138784	1	117,95	16
3881-54-1.6-THS-1/1.25	7311518269050	1	117,95	16
3881-67-1.6-THQ-1.4/2	7314150120369	1	133,53	16
3881-67-1.6-THQ-1/1.25	7314150180097	1	133,53	16
3881-67-1.6-THQ-2/3	7311518328832	1	83,20	16
3881-67-1.6-THS-1.4/2	7314150138791	1	145,67	16
3881-67-1.6-THS-1/1.25	7311518269043	1	145,67	16
3881-67-1.6-THS-2/3	7311518328849	1	146,23	16
3881-80-1.6-THQ-7/1	7311518332938	1	139,15	16
3881-80-1.6-THQ-1.4/2	7311518328856	1	139,15	16
3881-80-1.6-THQ-1/1.25	7314150133918	1	145,67	16
3881-80-1.6-THQ-2/3	7311518328863	1	192,85	16
3881-80-1.6-THS-7/1	7311518279202	1	151,36	16
3881-80-1.6-THS-1.4/2	7314150195312	1	151,36	16
3881-80-1.6-THS-2/3	7314150215942	1	192,85	16
38A-08	7314150433469	25	6,45	331
38A-10	7314150431564	25	7,13	331
38A-12	7314150237944	1	8,08	331
38A-15	7314150237951	25	9,43	331
38A-21	7314150237968	1	18,86	331
38A-26	7314150237975	1	21,54	331
38C-26	7314150237982	1	24,24	331
39-24	7314151831301	1	26,95	331
3905-250-24-100	7311518299255	100	2,20	558
3905-300-14-100	7311518292201	100	2,30	558
3905-300-18-100	7311518292218	100	2,30	558
3905-300-24-100	7311518292225	100	2,30	558
3905-300-24-2P	7311518299248	10	5,99	558
3905-300-32-100	7311518292232	100	2,15	558
3906-250-18-100	7311518250997	100	1,93	557
3906-250-18-5P	7314150265534	10	10,17	557
3906-250-24-100	7311518251000	100	1,93	557
3906-250-24-5P	7314150265541	10	10,17	557
3906-250-32-100	7311518251017	100	1,93	557
3906-250-32-5P	7314150265558	10	10,17	557
3906-300-14-100	7311518233563	100	2,17	557
3906-300-14-10P	7311518233693	10	33,86	557
3906-300-14-5P	7314150265565	10	11,45	557
3906-300-18-100	7311518233570	100	2,17	557
3906-300-18-10P	7311518233723	10	21,68	557
3906-300-18-2P	7311518233617	10	5,99	557
3906-300-18-5P	7314150265572	10	14,05	557
3906-300-24-100	7311518233587	100	2,17	557
3906-300-24-10P	7311518233730	10	27,59	557
3906-300-24-2P	7311518233624	10	5,99	557
3906-300-24-5P	7311518237417	10	14,05	557
3906-300-32-100	7311518233594	100	2,17	557
3906-300-32-10P	7311518233747	10	27,59	557
3906-300-32-2P	7311518233631	10	5,99	557
3906-300-32-5P	7311518237424	10	14,05	557
3906-300-3P	7311518233754	10	8,70	557
3911-115-IM-10P	7314150485703	10	12,01	142
3911-115-T41-AL	7314150485642	25	0,98	142
3911-115-T41-I	7314150454570	25	0,98	142
3911-115-T41-IM	7314150454587	50	0,93	142
3911-115-T42-M	7314150454679	25	0,88	142
3911-115T41-IM	7314150460595	50	0,93	142
3911-125-IM-10P	7314150485680	10	12,50	142
3911-125-T41-AL	7314150485666	25	0,98	142
3911-125-T41-I	7314150454594	25	1,13	142
3911-125-T41-IM	7314150454600	50	1,13	142
3911-125-T42-M	7314150454686	25	0,98	142
3911-125T41-IM	7314150485444	25	0,98	142
3911-150-T41-I	7314150454624	50	2,05	142
3911-150-T42-M	7314150454709	25	1,65	142
3911-180-T41-I	7314150454631	50	2,42	142
3911-180-T41-IM	7314150454655	50	2,16	142



3911-180-T42-M	7314150454693	25	2,16	142
3911-180T41-IM	7314150485468	50	1,69	142
3911-230-T41-I	7314150454648	50	3,08	142
3911-230-T41-IM	7314150454662	50	3,08	142
3911-230-T42-M	7314150454716	50	3,08	142
3911-2301922XDT	7314150522439	50	2,56	142
3911-2301T41-IM	7314150485482	50	2,33	142
3911-2302522XDT	7314150522415	50	2,44	142
3911-2303T41-IM	7314150485628	50	2,78	142
3911-350-X2TM	7314150486366	35	5,67	142
3911-400-F2TM	7314150485963	15	11,69	142
3911-400-X2TM	7314150502967	15	12,25	142
3911-751010XTM	7314150522392	10	1,12	142
3912-115-T41-IM	7314150454808	25	0,82	142
3912-115-T42-ST	7314150454723	25	1,03	142
3912-125-T41-IM	7314150454815	25	0,88	142
3912-125-T42-ST	7314150454730	25	1,24	142
3912-180-T42-ST	7314150454747	25	1,34	142
3912-230-T42-ST	7314150454754	50	2,16	142
3916-115-10P-CE	7314150455348	100	17,00	143
3916-115-10S-UE	7314150455270	100	11,64	143
3916-125-10P-CE	7314150455355	100	21,01	143
3916-125-10S-UE	7314150455287	100	14,32	143
3916-150-10S-UE	7314150455294	50	17,05	143
3916-180-10S-UE	7314150455300	50	18,08	143
3916-230-10L-RC	7314150455232	25	45,01	143
3916-230-10S-UE	7314150455317	25	25,39	143
3917-115-7S-C	7314150455324	100	6,15	143
3917-115-7S-U	7314150455249	100	6,28	143
3917-125-7S-C	7314150455331	100	8,14	143
3917-125-7S-U	7314150455256	100	8,34	143
3917-230-7S-U	7314150455263	25	18,54	143
3921-115-T27-IM	7314150454617	25	1,39	142
3921-125-T27-IM	7314150454761	25	1,75	142
3921-150-T27-IM	7314150454778	25	2,42	142
3921-180-T27-IM	7314150454785	25	2,78	142
3921-230-T27-IM	7314150454792	25	4,22	142
3926-115IM-C120	7314150454860	20	3,30	143
3926-115IM-C40	7314150454839	20	3,30	143
3926-115IM-C60	7314150454846	20	3,30	143
3926-115IM-C80	7314150454853	20	3,30	143
3926-125IM-C120	7314150454914	20	3,91	143
3926-125IM-C40	7314150454884	20	3,91	143
3926-125IM-C60	7314150454891	20	3,91	143
3926-125IM-C80	7314150454907	20	3,91	143
3927-115IM-P120	7314150454952	20	2,27	143
3927-115IM-P40	7314150454921	20	2,27	143
3927-115IM-P60	7314150454938	20	2,27	143
3927-115IM-P80	7314150454945	20	2,27	143
3927-125-120-3P	7314150499007	12	8,06	143
3927-125-40-3P	7314150498949	12	8,06	143
3927-125-60-3P	7314150498963	12	8,06	143
3927-125-80-3P	7314150498987	12	8,06	143
3927-125IM-P120	7314150455010	20	2,63	143
3927-125IM-P40	7314150454976	20	2,63	143
3927-125IM-P60	7314150454983	20	2,63	143
3927-125IM-P80	7314150455003	20	2,63	143
3940-100-14-SC-2P	7314150364466	10	5,39	134
3940-100-14-SC-5P	7314150364473	5	13,46	134
3940-100-14-ST-10P	7314150364336	1	25,73	134
3940-100-14-ST-2P	7314150364312	10	5,39	134
3940-100-14-ST-5P	7314150364329	5	13,46	134
3940-100-18-SC-2P	7314150364442	10	5,39	134
3940-100-18-SC-5P	7314150364459	5	13,46	134
3940-100-18-ST-10P	7314150364367	1	25,73	134
3940-100-18-ST-2P	7314150364343	10	5,39	134
3940-100-18-ST-5P	7314150364350	5	13,46	134
3940-100-24-SC-2P	7314150364558	10	5,39	134
3940-100-24-SC-5P	7314150364565	5	13,46	134
3940-100-24-ST-10P	7314150364435	1	25,73	134
3940-100-24-ST-2P	7314150364411	10	5,39	134
3940-100-24-ST-5P	7314150364428	5	13,46	134
3940-150-10-HST-10P	7314150364039	1	36,30	134
3940-150-10-HST-2P	7314150364015	10	8,01	134
3940-150-10-HST-5P	7314150364022	5	20,04	134
3940-150-10-ST-100P	7314150362196	1	319,99	134
3940-150-10-ST-10P	7314150362189	1	33,73	134
3940-150-10-ST-2P	7314150362165	10	7,08	134
3940-150-10-ST-5P	7314150362172	5	17,70	134
3940-150-14-HST-10P	7314150362370	1	36,70	134
3940-150-14-HST-2P	7314150362325	10	8,13	134
3940-150-14-HST-5P	7314150362363	5	20,33	134
3940-150-14-ST-100P	7314150364183	1	319,99	134
3940-150-14-ST-10P	7314150364176	1	33,73	134
3940-150-14-ST-2P	7314150364152	5	7,08	134
3940-150-14-ST-5P	7314150364169	5	17,70	134
3940-150-18-HST-10P	7314150364060	1	36,70	134
3940-150-18-HST-2P	7314150364046	10	8,13	134
3940-150-18-HST-5P	7314150364053	5	20,33	134
3940				



3940-150-24-ST-5P	7314150364381	5	17,70	134
3940-150-4/6-SC-10P	7314150361847	1	33,73	135
3940-150-4/6-SC-2P	7314150361823	10	9,27	135
3940-150-4/6-SC-5P	7314150361830	5	17,70	135
3940-150-5/8-DSL-10P	7314150361991	1	35,30	135
3940-150-5/8-DSL-2P	7314150361977	5	10,73	135
3940-150-5/8-DSL-5P	7314150361984	5	18,54	135
3940-150-5/8-SL-100P	7314150361724	1	319,99	135
3940-150-5/8-SL-10P	7314150361717	1	33,73	135
3940-150-5/8-SL-2P	7314150361687	10	9,27	135
3940-150-5/8-SL-5P	7314150361700	5	17,70	135
3940-150-6-ST-10P	7314150361786	1	33,73	135
3940-150-6-ST-2P	7314150361762	10	9,27	135
3940-150-6-ST-5P	7314150361779	5	17,70	135
3940-150-8/12-ST-100P	7314150362158	1	319,99	134
3940-150-8/12-ST-10P	7314150362141	1	33,73	134
3940-150-8/12-ST-2P	7314150362127	10	7,08	134
3940-150-8/12-ST-5P	7314150362134	5	17,70	134
3940-228-10-DSL-100P	7314150362035	1	609,48	135
3940-228-10-DSL-10P	7314150362028	1	60,94	135
3940-228-10-DSL-2P	7314150362004	10	13,52	135
3940-228-10-DSL-5P	7314150362011	5	33,78	135
3940-228-10-HST-100P	7314150362417	1	625,49	134
3940-228-10-HST-10P	7314150362400	1	46,04	134
3940-228-10-HST-2P	7314150362387	10	9,18	134
3940-228-10-HST-5P	7314150362394	5	24,98	134
3940-228-10-PR09-100P	7314150361625	1	414,29	135
3940-228-10-ST-100P	7314150362110	1	412,60	134
3940-228-10-ST-10P	7314150362103	1	43,32	134
3940-228-10-ST-2P	7314150362080	10	12,78	134
3940-228-10-ST-5P	7314150362097	5	22,95	134
3940-228-10/14-PR09-100P	7314150361526	1	311,77	135
3940-228-10/14-PR09-10P	7314150361519	1	31,19	135
3940-228-10/14-PR13-100P	7314150361649	1	429,06	135
3940-228-10/14-PR13-10P	7314150451265	1	42,90	135
3940-228-14-HST-10P	7314150362226	1	47,02	134
3940-228-14-HST-2P	7314150362202	10	10,23	134
3940-228-14-HST-5P	7314150362219	5	25,60	134
3940-228-14-ST-100P	7314150364145	1	412,60	134
3940-228-14-ST-10P	7314150364138	1	43,32	134
3940-228-14-ST-2P	7314150364114	5	9,18	134
3940-228-14-ST-5P	7314150364121	5	22,95	134
3940-228-18-HST-10P	7314150362271	1	50,40	134
3940-228-18-HST-2P	7314150362233	10	10,08	134
3940-228-18-HST-5P	7314150362264	5	25,19	134
3940-228-18-ST-100P	7314150364220	1	412,60	134
3940-228-18-ST-10P	7314150364213	1	43,32	134
3940-228-18-ST-2P	7314150364190	10	9,18	134
3940-228-18-ST-5P	7314150364206	5	22,95	134
3940-228-5/8-DSL-10P	7314150361939	1	45,68	135
3940-228-5/8-DSL-2P	7314150361915	10	10,73	135
3940-228-5/8-DSL-5P	7314150361922	5	23,87	135
3940-228-6-SL-10P	7314150361755	1	43,32	135
3940-228-6-SL-2P	7314150361731	10	10,73	135
3940-228-6-SL-5P	7314150361748	5	22,95	135
3940-228-8/12-PR13-100P	7314150361601	1	396,67	135
3940-228-8/12-ST-100P	7314150362073	1	412,60	134
3940-228-8/12-ST-10P	7314150362066	1	43,32	134
3940-228-8/12-ST-2P	7314150362042	5	9,18	134
3940-228-8/12-ST-5P	7314150362059	5	22,95	134
3940-300-10-HST-10P	7314150362448	1	54,04	134
3940-300-10-HST-2P	7314150362424	10	12,13	134
3940-300-10-HST-5P	7314150362431	5	30,35	134
3940-300-14-HST-10P	7314150362301	1	54,04	134
3940-300-14-HST-2P	7314150362288	10	12,18	134
3940-300-14-HST-5P	7314150362295	5	30,43	134
3940-300-14-ST-100P	7314150364268	1	513,43	134
3940-300-14-ST-10P	7314150364251	1	54,01	134
3940-300-14-ST-2P	7314150364237	5	11,31	134
3940-300-14-ST-5P	7314150364244	5	28,29	134
3940-300-18-HST-10P	7314150364008	1	52,96	134
3940-300-18-HST-2P	7314150363988	10	11,97	134
3940-300-18-HST-5P	7314150363995	5	29,96	134
3940-300-18-ST-100P	7314150364305	1	512,41	134
3940-300-18-ST-10P	7314150364299	1	54,01	134
3940-300-18-ST-2P	7314150364275	10	11,31	134
3940-300-18-ST-5P	7314150364282	5	28,29	134
3940-300-5/8-DSL-10P	7314150361960	1	56,69	135
3940-300-5/8-DSL-2P	7314150361946	10	11,91	135
3940-300-5/8-DSL-5P	7314150361953	5	29,73	135
3940-300-6-SL-10P	7314150361816	1	54,01	135
3940-300-6-SL-2P	7314150361793	10	10,73	135
3940-300-6-SL-5P	7314150361809	5	28,29	135
3940-300-8/12-SL-100P	7314150361908	1	502,13	135
3940-300-8/12-SL-10P	7314150361892	1	54,01	135
3940-300-8/12-SL-2P	7314150361878	5	10,73	135
3940-300-8/12-SL-5P	7314150361885	5	28,29	135
3940-HDD-SET-5P	7314150401703	5	33,52	137
3940-METAL-SET-12P	7314150511488	6	52,80	137
3940-METAL-SET-5P	7314150401673	5	22,00	137
3940-MIX-SET-10P	7314150401666	4	45,04	137
3940-MIX-SET-12P	7314150511501	6	54,04	137
3940-MIX-SET-5P	7314150401659	5	25,13	137
3942-150-7-SL-10P	7314150364534	1	35,80	136
3942-150-7-SL-2P	7314150364510	10	19,24	136
3942-150-7-SL-5P	7314150364527	5	19,24	136



3942-228-11-HSL-10P	7314150364831	1	30,84	136
3942-228-11-HSL-2P	7314150364817	10	8,74	136
3942-228-11-HSL-5P	7314150364824	5	18,44	136
3942-228-5-HSL-10P	7314150364657	1	46,05	136
3942-228-5-HSL-2P	7314150364633	10	12,26	136
3942-228-5-HSL-5P	7314150364640	5	25,00	136
3942-228-7-HSL-10P	7314150364749	1	43,32	136
3942-228-7-HSL-2P	7314150364725	10	12,05	136
3942-228-7-HSL-5P	7314150364732	5	23,46	136
3942-228-7-SL-10P	7314150364503	1	43,52	136
3942-228-7-SL-2P	7314150364480	10	9,31	136
3942-228-7-SL-5P	7314150364497	5	23,27	136
3942-300-5-HSL-10P	7314150364688	1	51,73	136
3942-300-5-HSL-2P	7314150364664	10	15,26	136
3942-300-5-HSL-5P	7314150364671	5	29,71	136
3942-300-7-HSL-10P	7314150364770	1	49,61	136
3942-300-7-HSL-2P	7314150364756	10	20,17	136
3942-300-7-HSL-5P	7314150364763	5	26,64	136
3942-300-7-SL-10P	7314150364619	1	48,20	136
3942-300-7-SL-2P	7314150364596	10	14,54	136
3942-300-7-SL-5P	7314150364602	5	27,94	136
3942-WOOD-SET-12P	7314150511525	6	70,40	137
3942-WOOD-SET-5P	7314150401680	5	29,33	137
3943-C30-JT-F	7314150422869	10	19,12	136
3943-C30-JT-M	7314150422876	10	19,12	136
3943-C35-JT-C	7314150422937	10	20,70	136
3943-C35-JT-M	7314150422883	10	21,37	136
3943-R28-UT-C-2P	7314150422951	10	16,87	137
3943-S20-JT-F	7314150422944	10	15,75	136
3944-300-3-MEAT-1P	7314150364862	10	11,43	138
3946-100-DG-ST-2P	7314150478644	10	9,13	135
3946-150-10-HST-1P	7314150478156	10	9,13	135
3946-150-6-DSL-1P	7314150478101	10	9,13	136
3946-150-6-SL-1P	7314150364916	5	24,50	138
3946-150-8-HST-1P	7314150478132	10	22,25	135
3946-150-DG-ST-2P	7314150478668	10	15,97	135
3946-228-10-HST-1P	7314150478255	10	35,38	135
3946-228-3-ST-1P	7314150364886	5	23,87	138
3946-228-6-DSL-1P	7314150478217	10	28,24	136
3946-228-8-HST-1P	7314150478231	10	30,81	135
3946-300-10-HST-1P	7314150478323	10	47,92	135
3946-300-2-CB-1P	7314150478354	10	34,23	138
3946-300-6-DSL-1P	7314150478286	10	31,95	136
3946-300-8-HST-10P	7314150539741	1	370,80	135
3946-300-8-HST-1P	7314150478309	10	39,82	135
3946-457-2-CB-1P	7314150478378	10	45,64	138
396-BLADE	7311518299057	100	15,88	634
396-BLADE-1P	7311518330613	1	14,52	634
396-HP	7311518152284	4	19,98	635
396-HP-BLADE	7311518156404	300	12,92	636
396-INS	7314150422708	10	25,96	561
396-JS	7311518223250	4	23,50	634
396-JS-BLADE	7311518223267	300	21,15	635
396-JT	7311518168056	4	23,50	635
396-JT-BLADE	7311518168063	300	21,15	636
396-LAP	7311518172367	10	38,44	634
4-138-06-1-0	7311518020927	10	7,60	27
4-138-06-1-2	7311518000592	5	10,79	27
4-138-08-1-0	7311518020934	10	9,78	27
4-138-08-1-2	7311518000615	5	13,01	27
4-138-10-1-0	7311518020958	10	12,04	27
4-138-10-1-2	7311518000646	5	15,09	27
4-138-12-1-0	7311518020965	5	16,82	27
4-138-12-1-2	7311518194734	5	19,48	27
4-140-06-1-0	7311518020989	10	7,95	27
4-140-08-1-0	7311518020996	10	9,92	27
4-140-08-1-2	7311518028169	5	13,01	27
4-140-10-1-2	7311518022488	10	12,18	27
4-140-10-1-2	7311518194741	5	15,34	27
4-142-06-1-0	7311518021016	10	7,33	27
4-142-08-1-0	7311518021023	10	8,48	27
4-142-10-1-0	7311518021030	10	11,09	27
4-144-08-2-0	7311518021054	10	10,25	28
4-144-08-2-2	7311518021319	5	13,39	28
4-152-08-2-2	7311518000691	5	16,44	28
4-153-08-1-2	7311518000707	5	16,44	28
4-154-08-2-2	7311518000714	10	31,18	28
4-155-08-2-0	7311518116194	10	12,22	28
4-155-10-2-0	7311518116200	5	16,18	28
4-183-04-2-0	7311518021108	10	4,40	28
4-183-04-2-2	7311518021401	5	6,19	28
4-183-05-2-0	7311518021122	10	5,09	28
4-183-05-2-2	7311518021418	5	7,59	28
4-183-06-2-0	7311518021139	10	6,06	28
4-183-06-2-2	7311518000769	5	7,78	28
4-183-07-2-0	7311518			



4-186-07-2-0	7311518021238	10	7,27	28
4-186-08-2-0	7311518021245	10	8,21	28
4-187-04-2-0	7311518021269	10	5,43	29
4-187-05-2-0	7311518021283	10	5,86	29
4-187-05-2-2	7311518201449	5	7,93	29
4-187-06-2-0	7311518021290	10	6,20	29
4-187-06-2-2	7311518022464	5	9,47	29
4-187-07-2-0	7311518021306	10	8,83	29
4-187-45-2-0	7311518021276	10	5,86	29
4-188-05-2-0	7311518021337	10	7,12	29
4-188-05-2-2	7311518201456	5	9,10	29
4-188-06-2-0	7311518021344	10	7,95	29
4-190-06-2-2	7311518000899	5	7,80	29
4-190-07-2-0	7311518021375	10	7,19	29
4-190-07-2-2	7311518000905	5	9,38	29
4-190-08-2-0	7311518021382	10	7,68	29
4-190-08-2-2	7311518000912	5	8,66	29
4-192-06-2-0	7311518021412	10	8,41	29
4-192-06-2-2	7311518201463	5	11,64	29
4-192-07-2-0	7311518021429	10	9,58	29
4-192-08-2-0	7311518021436	10	10,25	29
4-192-08-2-2	7311518201487	5	13,39	29
4-202-85-2-0	7311518021474	10	10,47	30
4-204-85-2-0	7311518021498	10	13,35	30
4-272-05-3-2	7311518201500	5	11,64	30
4-272-06-3-0	7311518021597	10	8,48	30
4-272-06-3-2	7311518001025	5	11,64	30
400.002.050	7314150249848	1	494,20	609
400.003.020	8412814403205	1	87,06	609
400.003.030	8412814403304	1	214,41	609
401-16	7314150400270	12	31,08	268
401-28	7314150384082	12	31,08	268
402-15-95	7314150485604	1	9,45	269
402-35	7314150384099	6	55,83	268
402-76	7314150384105	6	114,20	268
402-95-SET	7314150400997	1	36,79	269
4020L-M-3.2	7314151405038	5	19,59	43
4020L-M-3.5	7314151077709	5	19,59	43
4020L-M-4	7314151077716	5	18,50	43
4020L-M-4.5	7314151077723	5	18,50	43
4020L-M-5	7314151077730	5	18,50	43
4020L-M-5.5	7314151077747	5	18,50	43
4040M-10-11	7314151078287	1	40,76	59
4040M-10-13	7314153000750	1	45,27	59
4040M-12-13	7314151078294	1	42,45	59
4040M-13-17	7314151804565	1	44,25	59
4040M-14-15	7314151078300	1	44,50	59
4040M-16-17	7314151078317	1	48,56	59
4040M-16-18	7314151839635	1	50,02	59
4040M-18-19	7314151078324	1	55,34	59
4040M-20-22	7314151078331	1	65,74	59
4040M-21-23	7314151078348	1	68,49	59
4040M-6-7	7314151831967	1	38,95	59
4040M-8-9	7314151078270	1	39,89	59
4040M/6T	7314150112197	1	267,07	59
4040M/S6	7314150112180	1	283,48	59
4040Z-1/2-9/16	7314151831998	1	43,70	59
4040Z-13/16-7/8	7314150355099	1	57,12	59
4040Z-3/8-7/16	7314151831981	1	39,35	59
4040Z-5/8-11/16	7314151832001	1	46,58	59
4040Z-5/8-3/4	7314153001023	1	49,72	59
405-1000	7314150399758	5	60,82	540
405-1000-M	7314150399765	5	64,59	540
405-400	7314150399673	5	29,76	540
405-400-M	7314150399680	5	33,53	540
405-600	7314150399697	5	35,59	540
405-600-M	7314150399703	5	39,47	540
405-800	7314150399710	10	45,29	540
405-800-M	7314150399741	5	49,06	540
405L-400	7314150400461	10	27,18	540
405L-400-M	7314150400492	5	30,41	540
405L-600	7314150400478	10	33,01	540
405L-600-M	7314150400485	5	36,89	540
406-300	7314150183678	1	35,56	540
406-300-M	7314150183658	5	48,86	540
406-400	7314150183685	5	40,29	540
406-400-M	7314150183838	5	53,72	540
406-500	7314150183692	5	48,61	540
406-500-M	7314150186365	5	58,90	540
406-600	7314150245819	5	47,65	540
406-600-M	7314150245840	5	57,74	540
406-800	7314150245826	5	56,36	540
406P-400	7314150302574	10	10,20	540
406P-600	7314150302581	10	12,91	540
406T-225	7314150315130	10	6,80	541
407-1000	7314150369928	6	17,11	595
407-1400	7314150373703	6	19,13	595
407-700	7314150369911	5	15,41	595
407F-1000	7314150383801	6	19,76	595
407F-1400	7314150383818	6	22,56	595
407F-700	7314150383795	6	17,91	595
40B-115-165	7314153011879	25	60,81	60
40B-115-165-SP	7314153024459	1	4,27	60
40B-150-230	7314153024534	10	61,83	60
40B-19-50	7314153011848	25	24,23	60
40B-19-50-SP	7314153024473	1	3,61	60



40B-32-75	7314153011855	25	35,47	60
40B-32-75-SP	7314153024497	1	3,61	60
40B-50-120	7314153011862	20	44,73	60
40B-50-120-SP	7314153024510	1	4,27	60
4106-115-165	7314153024572	25	39,42	60
4106-150-230	7314153024596	10	88,11	60
4106-19-50	7314153011886	10	27,36	60
4106-32-75	7314153011893	25	39,88	60
4106-50-120	7314153024558	25	40,80	60
411-26	7314150412068	4	45,63	270
411-26-95	7314150412259	50	16,94	270
411-35	7314150412082	4	59,69	270
411-35-95	7314150412266	50	26,56	270
411-42	7314150412112	6	78,27	270
411-42-95	7314150412273	50	31,40	270
411-63	7314150412136	5	115,15	270
411-63-95	7314150412280	30	59,39	270
412-26-MULTI	7314150412174	5	85,57	270
412-26-MULTI-95	7314150412303	150	20,32	270
412-28-PEX	7314150412150	5	58,51	270
412-28-PEX-95	7314150412297	30	20,22	270
4124-JT-H	7311518267803	4	23,50	635
4128-JT-H	7311518267810	4	28,21	635
4130	7314150100019	3	47,87	233
413005000	8413345011860	12	63,78	598
413010000	8413345011877	12	105,08	598
413015000	8413345011884	12	138,00	598
413020000	8413345011891	6	180,83	598
413030000	8413345119986	1	183,55	598
413040000	8413345119993	1	243,68	598
4131	7314150100026	3	47,87	233
414-10	7311518238148	4	15,42	571
414-12	7311518238155	4	16,44	571
414-14	7311518238162	4	16,77	571
414-15	7311518238179	4	16,91	571
414-16	7311518238186	4	17,10	571
414-18	7311518238193	4	17,56	571
414-20	7311518238209	4	17,89	571
414-22	7311518238216	4	18,35	571
414-25	7311518238223	4	18,84	571
414-28	7311518238230	4	19,48	571
414-30	7311518238247	4	19,79	571
414-32	7311518238254	4	20,12	571
414-35	7311518238261	4	20,75	571
414-38	7311518238278	4	21,23	571
414-6	7311518238117	4	15,25	571
414-8	7311518238131	4	15,60	571
414-S3-EUR	7311518249205	1	52,83	571
416-1000	7314150314027	10	26,69	540
416-1200	7314150308798	10	30,26	540
416-1500	7314150314034	10	34,20	540
416-1800	7314150308804	10	39,77	540
416-2000	7314150308811	10	47,38	540
416-400	7314150314003	10	15,97	540
416-600	7314150308781	10	18,73	540
416-800	7314150314010	10	21,60	540
416-SET-1	7314150308828	5	68,26	541
416-SET-2	7314150308835	5	71,12	541
416-SET+BAG	7314150365470	1	101,07	540
41RM-10	7314153014429	1	24,04	45
41RM-11	7314153014436	1	25,27	45
41RM-12	7314153014443	1	27,28	45
41RM-13	7314153014450	1	28,07	45
41RM-14	7314153014467	1	29,43	45
41RM-17	7314153014474	1	33,27	45
41RM-19	7314153014481	1	37,59	45
41RM-21	7314150219742	1	39,20	45
41RM-8	7314153014412	1	22,07	45
41RM/SH8	7314150220656	10	234,58	46
41RZ-1/2	7314150359011	1	23,68	45
41RZ-11/16	7314150359042	1	30,08	45
41RZ-13/16	7314150359066	1	45,30	45
41RZ-3/4	7314150359059	1	31,32	45
41RZ-3/8	7314150358991	1	20,95	45
41RZ-5/16	7314150358984	1	19,80	45
41RZ-5/8	7314150359035	1	28,08	45
41RZ-7/16	7314150359004	1	21,66	45
41RZ-7/8	7314150359073	1	45,30	45
41RZ-9/16	7314150359028	1	25,01	45
420SC-25	7314150169825	10	5,72	589
420SC-50	7314150169832	5	8,53	589
420SH-100-200	7314150359691	10	36,97	588
420SH-120-1000	7314150359790	6	67,07	588
420SH-120-1250	7314150359806	6	76,20	588
420SH-120-1500	7314150359813	6	79,99	588
420SH-120-250	7314150359707	8	43,82	588
420SH-120-300	7314150359745	8	47,56	588
420SH-120-400	7314150359752	6	49,95	588
420SH-120-500	7314150359769	6	53,32	588
420SH-120-600	7314150359776	6	57,64	588
420SH-120-800	7314150359783	6	63,41	588
420SH-140-400	7314150359820	6	63,41	588
420SH-175-400	7314150359837	6	67,62	588
420SH-50-100	7314150359646	10	14,47	588
420SH-50-200	7314150359653	10	16,02	588
420SH-60-120	7314150359660	12	23,74	588



420SH-60-300	7314150359677	12	28,29	588
420SH-80-160	7314150359684	12	31,47	588
4211-11-6T	7311518152000	4	17,63	635
4211-14-6T	7311518128883	4	19,98	635
4212-11-6T	7311518002060	4	17,63	635
4212-14-6T	7311518002077	4	19,98	635
422P-10	7311518248369	4	36,86	572
422P-12	7311518248376	4	36,86	572
422P-16	7311518248383	4	36,86	572
422P-20	7311518248390	4	39,06	572
422P-25	7311518248406	4	46,40	572
422P-6	7311518248352	4	36,41	572
4231	7314150100033	3	65,81	235
4239	7314150100088	3	64,54	235
424P-10	7311518238315	4	19,10	570
424P-12	7311518238322	4	19,55	570
424P-14	7311518238339	4	20,01	570
424P-15	7311518238346	4	20,22	570
424P-16	7311518238353	4	20,46	570
424P-18	7311518238360	4	20,91	570
424P-20	7311518238377	4	21,36	570
424P-22	7311518238384	4	21,80	570
424P-24	7311518238391	4	22,26	570
424P-25	7311518238407	4	22,46	570
424P-26	7311518238414	4	22,71	570
424P-28	7311518238421	4	23,17	570
424P-30	7311518238438	4	23,62	570
424P-32	7311518238445	4	24,06	570
424P-35	7311518238452	4	24,74	570
424P-38	7311518238469	4	25,42	570
424P-4	7311518238285	4	17,75	570
424P-40	7311518238476	4	25,87	570
424P-6	7311518238292	4	18,20	570
424P-8	7311518238308	4	18,65	570
424P-S3-EUR	7311518249199	1	62,95	570
424P-S6-EUR	7311518269968	1	144,69	571
424P-S6-GER	7311518280086	1	134,56	571
424P-S6-LR	7314150423804	1	137,66	570
424P-S6-PP	7314150326662	1	97,98	571
424P-S8-EUR	7311518276393	1	197,31	571
425-081	7311518010669	1	47,95	572
425-082	7311518010676	1	76,39	572
425-083	7311518010683	1	100,87	572
425-10	7311518004613	4	14,54	572
425-12	7311518004620	4	14,89	572
425-14	7311518004637	4	15,23	572
425-15	7311518017767	4	15,41	572
425-16	7311518004644	4	15,58	572
425-18	7311518004651	4	15,94	572
425-20	7311518004668	4	16,27	572
425-22	7311518004675	4	16,60	572
425-24	7311518005993	4	16,97	572
425-25	7311518004682	4	17,13	572
425-26	7311518006006	4	17,30	572
425-28	7311518004699	4	17,64	572
425-30	7311518004705	4	18,01	572
425-32	7311518004712	4	18,32	572
425-35	7311518017774	4	18,86	572
425-38	7311518004729	4	19,40	572
425-4	7311518030810	4	13,51	572
425-40	7311518017781	4	19,69	572
425-6	7311518004590	4	14,01	572
425-8	7311518004606	4	14,21	572
426-1000	7311518004309	1	47,26	539
426-1200	7311518004316	1	55,59	539
426-400	7311518004255	1	31,61	539
426-600	7311518004279	1	35,65	539
426-800	7311518004293	1	39,82	539
426TOR9	7314150125319	10	23,03	541
427-13	7314150403578	4	21,09	592
427-16	7311518025410	4	29,09	592
427-20	7311518025427	4	30,08	592
427-24	7314150402878	4	32,60	592
427-700	7314150338092	6	24,02	592
427-8	7314150402854	4	19,15	592
427S-16	7314150404247	4	22,45	592
427S-20	7314150404261	4	24,76	592
428-16	7311518012380	4	27,36	592
428-700	7314150338108	6	31,10	593
428F-13	7314150436392	4	27,52	592
428F-16	7314150436408	4	30,65	592
428F-20	7314150436422	4	32,62	592
428F-24	7314150436439	4	44,67	592
428F-8	7314150436378	4	24,74	592
428S-16	7314150424030	4	30,65	592
428S-20	7314150424047	4	32,62	592
429-13	7311518012250	4	26,85	592
429-16	7311518012403	4	29,27	592
429-20	7311518012410	4	30,12	592
429-8	7311518040703	4	18,45	592
42RMS/12	7314150384785	1	342,97	46
4307	7314151079444	1	76,55	60
4310	7314151079451	1	103,45	60
434-10	7311518238506	4	23,94	570
434-12	7311518238513	4	24,51	570
434-14	7311518238520	4	25,08	570



434-15	7311518238537	4	25,34	570
434-16	7311518238544	4	25,77	570
434-18	7311518238551	4	26,19	570
434-20	7311518238568	4	26,73	570
434-22	7311518238575	4	27,43	570
434-25	7311518238582	4	28,13	570
434-28	7311518238599	4	29,14	570
434-30	7311518238605	4	29,56	570
434-32	7311518238612	4	30,12	570
434-35	7311518238629	4	30,94	570
434-38	7311518238636	4	31,93	570
434-50	7311518285388	4	36,65	570
434-6	7311518238483	4	22,84	570
434-8	7311518238490	4	23,56	570
434-S3-EUR	7311518249212	1	78,84	570
434-S6-EUR	7311518267544	1	156,01	570
434-S6-LR	7314150423811	1	175,73	570
434-S6-PP	7314150326655	1	158,05	570
434-S8-EUR	7311518295110	1	178,18	570
439000000	8413345129282	1	12,76	473
439000001	7314150268788	1	12,91	473
439000002	7314150309702	1	20,51	473
439000003	7314150309719	1	23,42	473
439000004	7314150427666	1	7,11	473
4400-11	7311518200596	10	11,45	636
4400-11-BULK	7311518200633	10	9,99	636
4400-14	7311518200602	10	12,92	636
4400-14-BULK	7311518200640	10	11,16	636
440102500	8413345098977	10	6,03	595
440103000	8413345098991	10	6,34	595
4411-1.00	7314150372744	1	4,72	151
4411-1.50	7314150372768	1	4,40	151
4411-10.00	7314150372973	1	9,54	151
4411-10.20	7314150372980	1	13,52	151
4411-10.50	7314150470488	1	14,17	151
4411-11.00	7314150372997	1	14,87	151
4411-11.50	7314150470495	1	16,95	151
4411-12.00	7314150373000	1	19,07	151
4411-12.50	7314150470501	1	21,38	151
4411-13.00	7314150373017	1	23,78	151
4411-2.00	7314150372775	1	4,61	151
4411-2.50	7314150372782	1	4,14	151
4411-3.00	7314150372799	1	3,98	151
4411-3.25	7314150372805	1	4,82	151
4411-3.30	7314150372812	1	4,82	151
4411-3.50	7314150372829	1	4,72	151
4411-4.00	7314150372836	1	5,14	151
4411-4.20	7314150372843	1	2,83	151
4411-4.25	7314150372850	1	2,83	151
4411-4.50	7314150372867	1	2,93	151
4411-5.00	7314150372874	1	3,04	151
4411-5.50	7314150372881	1	3,82	151
4411-6.00	7314150372898	1	3,98	151
4411-6.50	7314150372904	1	4,72	151
4411-6.80	7314150372911	1	4,51	151
4411-7.00	7314150372928	1	5,14	151
4411-7.50	7314150372935	1	5,56	151
4411-8.00	7314150372942	1	6,49	151
4411-8.50	7314150372959	1	6,81	151
4411-9.00	7314150372966	1	8,59	151
4411-9.50	7314150394463	1	8,70	151
4413-1.00	7314150371754	1	3,45	152
4413-1.50	7314150371761	1	2,73	152
4413-10.00	7314150372034	1	5,95	152
4413-10.20	7314150372041	1	7,64	152
4413-10.50	7314150470556	25	7,95	152
4413-11.00	7314150372058	1	8,75	152
4413-11.50	7314150470563	25	9,48	152
4413-12.00	7314150372065	1	10,34	152
4413-12.50	7314150470570	25	11,28	152
4413-13.00	7314150372072	1	11,83	152
4413-2.00	7314150371785	1	2,73	152
4413-2.50	7314150371792	1	2,73	152
4413-3.00	7314150371815	1	2,77	152
4413-3.25	7314150371822	1	2,77	152
4413-3.30	7314150371877	1	2,77	152
4413-3.50	7314150371884	1	2,77	152
4413-4.00	7314150371891	1	2,97	152
4413-4.20	7314150371907	1	1,85	152
4413-4.25	7314150371914	1	1,85	152
4413-4.50	7314150371921	1	1,95	152
4413-5.00	7314150371938	1	2,11	152
4413-5.50	7314150371945	1	2,90	152
4413-6.00	7314150371952	1	2,90	152
4413-6.50	7314150371969	1	3,39	152
4413-6.80	7314150371976	1	3,82	152
4413-7.00	7314150371983	1	3,98	152
4413-7.50	7314150371990	1	4,27	152
4413-8.00	7314150372003	1	4,54	152
4413-8.50	7314150372010	1	4,93	152
4413-9.00	7314150372027	1	6,27	152
4413-9.50	7314150394456	1	5,82	152
4415-1.00	7314150394210	1	0,91	153
4415-1.50	7314150394227	1	0,91	153
4415-10.00	7314150394401	1	2,21	153
4415-10.50	7314150470525	1	2,40	153





4415-11.00	7314150394418	1	2,93	153
4415-11.50	7314150470532	1	3,15	153
4415-12.00	7314150394425	1	3,46	153
4415-12.50	7314150470549	1	3,68	153
4415-13.00	7314150394432	1	3,88	153
4415-13.50	7314150441495	1	5,18	153
4415-14.00	7314150441501	1	5,55	153
4415-14.50	7314150441518	1	6,28	153
4415-15.00	7314150441525	1	6,78	153
4415-15.50	7314150441532	1	7,52	153
4415-16.00	7314150441549	1	8,06	153
4415-16.50	7314150441556	1	8,61	153
4415-17.00	7314150441563	1	9,11	153
4415-17.50	7314150441570	1	10,06	153
4415-18.00	7314150441587	1	10,41	153
4415-18.50	7314150441594	1	11,33	153
4415-19.00	7314150441600	1	11,83	153
4415-19.50	7314150441617	1	12,31	153
4415-2.00	7314150394234	1	0,91	153
4415-2.50	7314150394241	1	0,91	153
4415-20.00	7314150441624	1	12,93	153
4415-3.00	7314150394258	1	0,91	153
4415-3.25	7314150394265	1	1,04	153
4415-3.50	7314150394272	1	1,12	153
4415-4.00	7314150394289	1	1,12	153
4415-4.25	7314150394296	1	0,76	153
4415-4.50	7314150394302	1	0,83	153
4415-5.00	7314150394319	1	0,83	153
4415-5.50	7314150394326	1	0,91	153
4415-6.00	7314150394333	1	0,95	153
4415-6.50	7314150394340	1	1,04	153
4415-7.00	7314150394357	1	1,12	153
4415-7.50	7314150394364	1	1,31	153
4415-8.00	7314150394371	1	1,58	153
4415-8.50	7314150394388	1	1,78	153
4415-9.00	7314150394395	1	1,88	153
442	7311518002848	10	14,10	548
442 B	7314150008957	1	67,87	266
442-3P	7314150309610	10	22,85	548
4420-11	7311518200619	10	11,45	636
4420-11-BULK	7311518200657	10	9,99	636
4420-14	7311518200626	10	12,92	636
4420-14-BULK	7311518200664	10	11,16	636
443 B	7314150008971	1	80,23	266
4430	7314150100040	3	41,08	245
4435-12.4	7314150465163	1	7,61	154
444 B	7314150009008	1	107,96	266
4480/2-ZD	7311518276911	1	155,68	271
4480IM	7314150263165	1	59,70	271
4480MM	7314150263158	1	59,70	271
449	7311518005337	10	13,30	548
44Z-1/2-9/16	7314150375233	10	33,89	53
44Z-1/4-5/16	7314150375196	10	21,36	53
44Z-11/16-13/16	7314150375264	5	52,62	53
44Z-11/16-3/4	7314150375257	5	41,94	53
44Z-3/8-7/16	7314150375219	10	24,61	53
44Z-5/16-3/8	7314150375202	10	21,36	53
44Z-5/8-3/4	7314150375240	5	41,94	53
44Z-7/16-1/2	7314150375226	10	28,55	53
451	7311518014506	10	15,52	548
4511-0.50-10P	7314150373079	1	26,60	151
4511-0.75-10P	7314150373062	1	24,04	151
4511-1.00-10P	7314150373055	1	19,48	151
4511-1.50-10P	7314150373086	1	18,55	151
4511-1.75-10P	7314150373093	1	23,25	151
4511-10.00-5P	7314150373444	1	44,53	151
4511-10.20-5P	7314150373468	1	62,85	151
4511-10.30-5P	7314150373475	1	74,89	151
4511-10.50-5P	7314150373482	1	63,05	151
4511-10.80-5P	7314150373499	1	87,15	151
4511-11.00-5P	7314150373505	1	69,66	151
4511-11.50-5P	7314150373512	1	83,28	151
4511-12.00-5P	7314150373529	1	89,25	151
4511-12.50-5P	7314150373536	1	108,67	151
4511-12.80-5P	7314150373543	1	124,12	151
4511-13.00-5P	7314150373550	1	111,03	151
4511-13.50-1P	7314150373567	1	24,51	151
4511-14.00-1P	7314150373574	1	24,20	151
4511-14.50-1P	7314150373581	1	34,36	151
4511-15.00-1P	7314150373598	1	34,89	151
4511-15.50-1P	7314150373604	1	40,43	151
4511-16.00-1P	7314150373611	1	41,80	151
4511-16.50-1P	7314150373628	1	47,76	151
4511-17.00-1P	7314150373635	1	47,76	151
4511-17.50-1P	7314150373642	1	53,00	151
4511-18.00-1P	7314150373659	1	57,72	151
4511-18.50-1P	7314150373673	1	63,68	151
4511-19.00-1P	7314150373680	1	63,80	151
4511-19.50-1P	7314150373697	1	70,71	151
4511-2.00-10P	7314150373109	1	19,48	151
4511-2.50-10P	7314150373116	1	17,70	151
4511-2.70-10P	7314150373123	1	21,94	151
4511-2.90-10P	7314150373130	1	21,94	151
4511-20.00-1P	7314150373666	1	75,74	151
4511-3.00-10P	7314150373147	1	17,29	151
4511-3.10-10P	7314150373185	1	21,15	151



4511-3.25-10P	7314150373192	1	21,15	151
4511-3.30-10P	7314150373208	1	21,15	151
4511-3.50-10P	7314150373215	1	21,15	151
4511-3.80-10P	7314150373222	1	26,60	151
4511-4.00-10P	7314150373239	1	22,42	151
4511-4.20-10P	7314150373246	1	24,93	151
4511-4.50-10P	7314150373253	1	25,13	151
4511-4.80-10P	7314150373260	1	29,54	151
4511-5.00-10P	7314150373277	1	26,60	151
4511-5.20-10P	7314150373284	1	32,16	151
4511-5.50-10P	7314150373291	1	33,73	151
4511-6.00-10P	7314150373307	1	35,82	151
4511-6.20-10P	7314150373314	1	44,83	151
4511-6.50-10P	7314150373321	1	43,05	151
4511-6.80-10P	7314150373338	1	50,18	151
4511-7.00-10P	7314150373345	1	47,24	151
4511-7.20-10P	7314150373352	1	68,34	151
4511-7.50-10P	7314150373369	1	50,18	151
4511-7.80-10P	7314150373376	1	82,23	151
4511-8.00-10P	7314150373383	1	59,07	151
4511-8.50-10P	7314150373390	1	61,17	151
4511-8.60-10P	7314150373406	1	100,04	151
4511-8.80-10P	7314150373413	1	100,04	151
4511-9.00-10P	7314150373420	1	78,56	151
4511-9.20-10P	7314150373437	1	110,93	151
4511-9.50-10P	7311518339081	1	81,18	151
4511-9.60-10P	7314150373451	1	130,41	151
4511-SET-19	7314150373031	1	82,65	151
4511-SET-25	7314150373048	1	193,77	152
4511-SET-6	7314150373024	1	20,33	151
4513-1.00-10P	7314150372119	1	17,29	152
4513-1.50-10P	7314150372126	1	12,89	152
4513-1.75-10P	7314150372133	1	14,35	152
4513-10.00-5P	7314150391998	1	30,13	152
4513-10.20-5P	7314150392001	1	37,90	152
4513-10.30-5P	7314150392018	1	48,06	152
4513-10.50-5P	7314150392025	1	39,43	152
4513-10.80-5P	7314150392032	1	59,28	152
4513-11.00-5P	7314150392049	1	43,07	152
4513-11.50-5P	7314150392056	1	47,13	152
4513-12.00-5P	7314150392063	1	51,45	152
4513-12.50-5P	7314150392070	1	56,31	152
4513-12.80-5P	7314150392087	1	98,58	152
4513-13.00-5P	7314150392094	1	58,84	152
4513-13.50-1P	7314150392100	1	20,32	152
4513-14.00-1P	7314150392117	1	21,87	152
4513-14.50-1P	7314150392124	1	23,46	152
4513-15.00-1P	7314150392131	1	23,76	152
4513-15.50-1P	7314150392148	1	27,15	152
4513-16.00-1P	7314150392155	1	28,94	152
4513-16.50-1P	7314150392162	1	32,01	152
4513-17.00-1P	7314150392179	1	32,01	152
4513-17.50-1P	7314150392186	1	36,84	152
4513-18.00-1P	7314150392193	1	38,97	152
4513-18.50-1P	7314150392200	1	43,24	152
4513-19.00-1P	7314150392216	1	43,24	152
4513-19.50-1P	7314150392223	1	46,39	152
4513-2.00-10P	7314150372140	1	12,15	152
4513-2.50-10P	7314150372157	1	12,47	152
4513-2.70-10P	7314150372164	1	15,09	152
4513-2.90-10P	7314150372171	1	15,09	152
4513-20.00-1P	7314150392230	1	52,79	152
4513-3.00-10P	7314150372188	1	11,00	152
4513-3.10-10P	7314150372195	1	12,89	152
4513-3.25-10P	7314150372201	1	12,89	152
4513-3.30-10P	7314150372218	1	12,89	152
4513-3.50-10P	7314150372225	1	12,89	152
4513-3.80-10P	7314150372232	1	18,33	152
4513-4.00-10P	7314150372249	1	16,34	152
4513-4.20-10P	7314150372256	1	18,02	152
4513-4.50-10P	7314150372263	1	18,85	152
4513-4.80-10P	7314150372270	1	20,64	152
4513-5.00-10P	7314150372287	1	20,69	152
4513-5.20-10P	7314150372294	1	23,05	152
4513-5.50-10P	7314150372300	1	26,81	152
4513-6.00-10P	7314150372317	1	27,65	152
4513-6.20-10P	7314150372324	1	31,42	152
4513-6.50-10P	7314150372331	1	32,26	152
4513-6.80-10P	7314150372348	1	36,87	152
4513-7.00-10P	7314150372355	1	38,97	152
4513-7.20-10P	7314150372362	1	49,23	152
4513-7.50-10P	7314150372379	1	41,48	152
4513-7.80-10P	7314150372386	1	60,26	152
4513-8.00-10P	7314150372393	1	46,93	152
4513-8.50-10P	7314150372409	1	51,11	152
4513-8.60-10P	7314150372416	1	80,96	152
4513-8.80-10P	7314150372423	1	82,68	152
4513-9.00-10P	7314150372430	1	62,00	152
4513-9.20-10P	7314150372447	1	84,04	152
4513-9.50-10P	7314150372454	1	59,76	152
4513-9.60-10P	7314150372461	1	95,01	152
4513-SET-19	7314150372096	1	57,11	152
4513-SET-25	7314150372102	1	121,82	153
4513-SET-6	7314150372089	1	15,89	152
4515-1.00-10P	7314150441228	1	3,66	153
4515-1.50-10P	7314150441235</			



4515-10.00-10P	7314150441426	1	23,05	153
4515-10.50-5P	7314150441433	1	12,70	153
4515-11.00-5P	7314150441440	1	14,82	153
4515-11.50-5P	7314150441457	1	15,77	153
4515-12.00-5P	7314150441464	1	16,23	153
4515-12.50-5P	7314150441471	1	17,38	153
4515-13.00-5P	7314150441488	1	18,53	153
4515-2.00-10P	7314150441242	1	3,66	153
4515-2.50-10P	7314150441259	1	3,66	153
4515-3.00-10P	7314150441266	1	3,66	153
4515-3.25-10P	7314150441273	1	5,03	153
4515-3.50-10P	7314150441280	1	5,48	153
4515-4.00-10P	7314150441297	1	5,48	153
4515-4.25-10P	7314150441303	1	6,77	153
4515-4.50-10P	7314150441310	1	6,77	153
4515-5.00-10P	7314150441327	1	7,25	153
4515-5.50-10P	7314150441334	1	8,22	153
4515-6.00-10P	7314150441341	1	8,70	153
4515-6.50-10P	7314150441358	1	9,18	153
4515-7.00-10P	7314150441365	1	12,70	153
4515-7.50-10P	7314150441372	1	14,01	153
4515-8.00-10P	7314150441389	1	14,99	153
4515-8.50-10P	7314150441396	1	18,33	153
4515-9.00-10P	7314150441402	1	20,58	153
4515-9.50-10P	7314150441419	1	22,86	153
4515-SET-19	7314150394449	1	22,62	153
4515-SET-25	7314150441709	1	44,21	153
4518-3	7314151716547	1	254,45	367
4518-4	7314151716622	1	310,89	367
4518-5	7314151716899	1	321,49	367
4519-1	7314151716974	1	270,35	366
4519-1/S	7314151843762	1	61,51	365
4519-2	7314151717193	1	354,97	366
4519-3	7314151717278	1	405,06	366
4521N-0	7314151837723	1	75,62	367
4521N-00	7314151837716	1	75,63	367
4521N-A	7314151837730	1	72,08	367
4521N-B	7314151837747	1	72,08	367
4521N-C	7314151837754	1	74,31	367
4521N-D	7314151837761	1	74,31	367
4521N-E	7314151837778	1	74,31	367
4521N-F	7314151837785	1	84,52	367
4521N-G	7314151837792	1	84,52	367
4521N-H	7314151837808	1	86,95	367
4521N-I	7314151837815	1	96,55	367
4521N-K	7314151837822	1	118,97	367
4521N-L	7314151837839	1	118,97	367
4521N-M	7314151837846	1	148,43	367
4521N-S	7314151839789	1	356,01	367
4521N-T	7314151839796	1	424,78	367
4521N/7	7314151839802	1	1.196,54	367
4522-1	7314151081591	1	64,56	367
4522-2	7314151081614	1	102,02	367
4523G	7314151846695	1	76,44	367
4524G	7314151718596	1	108,61	367
4528-1	7314151718671	1	1.168,83	365
4528M1	7314151718916	1	123,96	365
4528M2	7314151719050	1	220,66	365
4528M3	7314151719135	1	328,83	365
4528M4	7314151719210	1	397,08	365
4528M5	7314151719487	1	407,22	365
4529-15	7314151719647	1	267,36	364
4529-8	7314151719562	1	222,01	364
4530	7314150100095	3	43,35	246
4532-0	7314151719722	1	122,51	364
4532-A	7314151082109	1	108,82	364
4532-AL	7314150221912	1	116,99	364
4532-B	7314151082116	1	113,69	364
4532-BL	7314150221929	1	123,93	364
4532-C	7314151082123	1	188,42	364
4532-CD/S	7314151818067	1	49,89	364
4532-CL	7314150221936	1	208,03	364
4532-D	7314151082130	1	194,89	364
4532-E	7314151082147	1	304,40	364
4532-EFG/S	7314151838386	1	89,23	364
4532-F	7314151082154	1	337,81	364
4532-G	7314151082161	1	564,50	364
4532-G-SO	7314151841003	1	653,40	364
4532-H	7314151719999	1	1.033,37	364
4532-H/S	7314151838393	1	139,82	364
4532-OAB/S	7314151818050	1	26,35	364
4532K1	7314151082185	1	58,88	364
4532K2	7314151082192	1	99,65	364
4532K3	7314151082208	1	165,43	364
4532K4	7314151720148	1	289,57	364
4532LK1	7314151082215	1	79,59	364
4532LK2	7314151082222	1	133,04	364
4532LK3	7314151082239	1	223,02	364
4532LK4	7314151082246	1	267,75	364
4532LK5	7314151720223	1	280,38	364
4532ST/5	7314151720490	1	920,85	364
4533HP	7314151793043	1	2.711,70	364
4533HP/S	7314150224487	1	585,90	364
4533HPK	7314150224500	1	638,91	364
4533M	7314151793050	1	2.474,61	364
4533M/S	7314150224494	1	194,70	364



4533MK	7314150224517	1	459,36	364
4537-1	7314151720650	1	98,05	365
4537-2	7314151720735	1	175,44	365
4537-3	7314151720810	1	253,81	365
4537-4	7314151721039	1	299,04	365
4540-17	7314150125005	1	258,62	366
4540-17/S	7314150225248	1	39,50	366
4540-25	7314150125012	1	382,24	366
4540-25/S	7314150225286	1	49,35	366
4541-A	7314151082413	1	109,87	365
4541-B	7314151082420	1	184,42	365
4542-A	7314151082451	1	142,07	365
4542-B	7314151082468	1	234,86	365
4543-1	7314151082499	1	35,64	365
4543-1/S	7314151818623	1	15,06	365
4543-10	7314151721466	1	49,32	365
4543-2	7314151082505	1	37,64	365
4543-2/S	7314151818661	1	15,07	365
4543-20	7314151721541	1	53,31	365
4543-3	7314151721381	1	65,63	365
4543-3/S	7314151818708	1	18,03	365
4543-30	7314151721626	1	75,48	365
4544-1	7314151844004	1	81,03	365
4544-10	7314151844042	1	116,74	365
4544-110/S	7314150224777	1	19,51	365
4544-2	7314151844011	1	128,25	365
4544-20	7314151844059	1	174,49	365
4544-220/S	7314150224784	1	38,45	365
4544-3	7314151844028	1	192,28	365
4544-30	7314151844066	1	256,56	365
4544-4	7314151844035	1	262,43	365
4544-440/S	7314150224791	1	46,73	365
4545-1	7314151082543	1	58,58	368
4545-2	7314151082550	1	79,64	368
4545-3	7314151082567	1	103,55	368
4545-4	7314151722272	1	136,30	368
4545-5	7314151722357	1	166,49	368
4545-N1	7314151722432	1	119,81	367
4545-N11	7314150249169	1	281,45	367
4545-N2	7314151804947	1	164,62	367
4545-N21	7314150249176	1	206,15	367
4551-A	7314151082628	1	90,32	366
4551-B	7314151722784	1	114,73	366
4551-C	7314151082642	1	187,07	366
4551-D	7314151082659	1	292,44	366
4552-1	7314151722944	1	142,96	366
4552-2	7314151723088	1	206,56	366
4552-3	7314151723163	1	318,65	366
4553	7314151830649	1	64,31	368
4559-12	7314150113132	1	87,34	239
4559-12A JC	7314150223909	1	53,77	239
4559-18	7314150024513	8	108,60	239
4559-18B JC	7314150113880	1	69,51	239
4559-24	7314150024520	6	129,39	239
4559-24B JC	7314150113897	1	82,81	239
4559-30	7314150024537	5	155,58	239
4559-30B JC	7314150113903	1	99,57	239
4559-36	7314150024544	3	204,21	239
4559-36B JC	7314150113910	1	130,70	239
4559-42	7314150024551	2	286,15	239
4559-42A JC	7314150208876	1	126,49	239
4560-210	7314150178995	1	55,73	239
4574	7314151799014	1	1.153,30	366
4577	7314151838348	1	1.482,71	368
4578	7314150222308	1	597,74	367
4579	7314150222018	1	237,80	368
4580N/7	7314151301361	1	1.527,27	366
4581N-1	7314151724139	1	62,07	366
4581NA	7314151301200	1	82,41	366
4581NB	7314151301217	1	88,76	366
4581NB2	7314151724726	1	94,95	366
4581NC	7314151301224	1	95,17	366
4582N-1	7314151724214	1	62,07	366
4582N-2	7314151724481	1	77,81	366
4582NA	7314151301248	1	101,73	366
4582NB	7314151301255	1	106,16	366
4583N-1	7314151724566	1	98,05	366
4583N-2	7314151724641	1	117,24	366
4583NA	7314151301279	1	162,35	366
4583NB	7314151301286	1	266,15	366
4590SHS5	7314150384822	4	200,60	368
4591	7314151804039	1	65,27	368
4592	7314151804046	1	76,11	368
4593	7314151804053	1	93,36	368
4594VWT4	7314150403639	5	355,90	335
45S/H1.5	7314150218530	1	17,56	165
45S/H1.5-2P	7314150261505	1	7,02	165
45S/H2	7314150218547	1	17,56	165
45S/H2-2P	7314150261512	1	7,02	165
45S/H2.5	7314150218554	1	17,56	165
45S/H2.5-2P	7314150261529	1	7,02	165
45S/H3	7314150218561	1	17,56	165
45S/H3-2P	7314150261536	1	7,02	165
45S/PH1	7314150218516	1	16,89	165
45S/PH1-2P	7314150261482	1	6,75	165
45S/PH2	7314150218523	1	18,93	165



45S/PH2-2P



45S/PH2-2P	7314150261499	1	7,57	165
4610-1	7314151724993	1	236,47	368
4611-2	7314151725372	1	79,11	368
4611-3	7314150125043	1	154,96	368
4614-1	7314151725457	1	154,87	366
4614-2	7314151725532	1	189,27	366
4626-10.0	7314150457670	1	9,25	156
4626-4.0	7314150457632	1	5,54	156
4626-5.0	7314150457649	1	6,10	156
4626-6.0	7314150457656	1	6,40	156
4626-8.0	7314150457663	1	7,64	156
4629-10.0	7314150465385	1	8,25	156
4629-4.0	7314150465347	1	5,30	156
4629-5.0	7314150465354	1	5,55	156
4629-6.0	7314150465361	1	6,16	156
4629-8.0	7314150465378	1	7,40	156
4629-SET-5	7314150467204	10	35,55	156
4630	7314150216154	1	23,60	610
4641-10-120	7314150383085	1	5,49	150
4641-10-200	7314150383115	1	8,49	150
4641-10-400	7314150383207	1	13,95	150
4641-10-600	7314150383221	1	15,45	150
4641-11-150	7314150383122	1	6,35	150
4641-12-150	7314150383139	1	7,46	150
4641-12-200	7314150383146	1	10,53	150
4641-12-400	7314150383238	1	14,82	150
4641-12-600	7314150383245	1	16,81	150
4641-13-150	7314150383153	1	10,53	150
4641-14-150	7314150383160	1	12,26	150
4641-14-400	7314150383252	1	18,20	150
4641-14-600	7314150383269	1	20,39	150
4641-16-150	7314150383177	1	13,55	150
4641-16-400	7314150383276	1	20,22	150
4641-16-600	7314150383283	1	26,02	150
4641-18-400	7314150383290	1	29,52	150
4641-18-600	7314150383306	1	35,03	150
4641-20-400	7314150383313	1	31,29	150
4641-20-600	7314150383320	1	40,59	150
4641-22-400	7314150383337	1	35,96	150
4641-24-400	7314150383344	1	37,28	150
4641-25-400	7314150383351	1	42,58	150
4641-3-60	7314150382859	1	3,27	150
4641-4-75	7314150382866	1	3,44	150
4641-5-150	7314150382880	1	4,75	150
4641-5-85	7314150382873	1	3,60	150
4641-5-5-85	7314150382897	1	3,60	150
4641-6-100	7314150383016	1	3,71	150
4641-6-150	7314150383023	1	4,93	150
4641-6-400	7314150383184	1	12,32	150
4641-6-5-100	7314150383030	1	3,71	150
4641-7-100	7314150383047	1	4,19	150
4641-8-120	7314150383054	1	4,86	150
4641-8-200	7314150383061	1	7,15	150
4641-8-400	7314150383191	1	13,06	150
4641-9-120	7314150383078	1	4,86	150
4641-PB	7314150383368	1	21,50	150
4643-PB	7314150441679	1	12,63	150
4651-10-1000	7314150386413	1	100,34	149
4651-10-110	7314150386345	1	11,73	149
4651-10-160	7314150386352	1	12,47	149
4651-10-160-10P	7314150475483	1	124,71	149
4651-10-210	7314150386369	1	14,87	149
4651-10-210-10P	7314150475513	1	156,49	149
4651-10-260	7314150386376	1	19,27	149
4651-10-310	7314150386383	1	24,51	149
4651-10-450	7314150386390	1	33,52	149
4651-10-600	7314150386406	1	42,73	149
4651-12-1000	7314150386581	1	100,76	149
4651-12-160	7314150386529	1	15,62	149
4651-12-160-10P	7314150475490	1	156,13	149
4651-12-210	7314150386536	1	18,65	149
4651-12-210-10P	7314150475520	1	186,44	149
4651-12-260	7314150386543	1	22,53	149
4651-12-310	7314150386550	1	29,23	149
4651-12-450	7314150386567	1	36,57	149
4651-12-600	7314150386574	1	43,90	149
4651-14-1000	7314150386659	1	135,12	149
4651-14-160	7314150386598	1	18,02	149
4651-14-210	7314150386604	1	24,10	149
4651-14-260	7314150386611	1	26,71	149
4651-14-310	7314150386628	1	34,47	149
4651-14-450	7314150386635	1	43,37	149
4651-14-600	7314150386642	1	60,54	149
4651-15-160	7314150386666	1	27,76	149
4651-15-260	7314150386673	1	36,14	149
4651-15-450	7314150386680	1	46,83	149
4651-16-1000	7314150386765	1	160,26	149
4651-16-160	7314150386697	1	34,47	149
4651-16-210	7314150386710	1	38,65	149
4651-16-260	7314150386727	1	44,73	149
4651-16-310	7314150386734	1	46,61	149
4651-16-450	7314150386741	1	58,55	149
4651-16-600	7314150386758	1	78,56	149
4651-18-250	7314150386789	1	59,92	149
4651-18-450	7314150386796	1	70,38	149
4651-20-250	7314150386802	1	68,08	149



4651-20-450	7314150386819	1	80,55	149
4651-22-250	7314150386826	1	81,60	149
4651-22-450	7314150386833	1	97,10	149
4651-24-250	7314150386840	1	82,92	149
4651-24-450	7314150386857	1	102,75	149
4651-25-250	7314150386864	1	85,19	149
4651-25-450	7314150386871	1	104,22	149
4651-28-250	7314150386888	1	98,46	149
4651-28-450	7314150386895	1	119,41	149
4651-30-250	7314150386901	1	125,93	149
4651-30-450	7314150386918	1	130,93	149
4651-32-450	7314150386925	1	169,69	149
4651-5-110	7314150385683	1	7,86	149
4651-5-110-10P	7314150475407	1	78,61	149
4651-5-160	7314150385690	1	8,80	149
4651-5-160-10P	7314150475438	1	87,98	149
4651-5-260	7314150385713	1	16,34	149
4651-5-5-110	7314150385720	1	10,69	149
4651-5-5-110-10P	7314150475414	10	106,84	149
4651-5-5-160	7314150385737	1	11,11	149
4651-5-5-160-10P	7314150475445	1	111,03	149
4651-6-110	7314150385744	1	7,86	149
4651-6-110-10P	7314150475421	1	78,61	149
4651-6-160	7314150385751	1	8,59	149
4651-6-160-10P	7314150475452	1	75,16	149
4651-6-210	7314150385768	1	11,64	149
4651-6-260	7314150385775	1	13,82	149
4651-6-310	7314150385782	1	20,43	149
4651-6-5-110	7314150475391	50	11,09	149
4651-6-5-160	7314150385799	1	11,22	149
4651-6-5-160-10P	7314150475469	1	111,03	149
4651-6-5-210	7314150385805	1	15,09	149
4651-6-5-260	7314150385812	1	20,12	149
4651-6-5-310	7314150385829	1	24,51	149
4651-7-110	7314150385836	1	10,59	149
4651-7-160	7314150386253	1	11,22	149
4651-8-110	7314150386277	1	10,26	149
4651-8-160	7314150386284	1	10,37	149
4651-8-160-10P	7314150475476	1	103,76	149
4651-8-210	7314150386291	1	12,89	149
4651-8-210-10P	7314150475506	1	128,89	149
4651-8-260	7314150386307	1	14,15	149
4651-8-310	7314150386314	1	18,13	149
4651-8-460	7314150386321	1	29,96	149
4651-SET-5	7314150475537	1	43,75	149
4651-SET-7	7314150475544	1	66,41	149
4652-10-110	7314150385119	1	6,19	149
4652-10-160	7314150385126	1	6,91	149
4652-10-160-10P	7314150475322	1	69,13	149
4652-10-210	7314150385133	1	8,28	149
4652-10-210-10P	7314150475353	1	82,81	149
4652-10-260	7314150385140	1	12,15	149
4652-10-310	7314150385164	1	14,15	149
4652-10-450	7314150385171	1	22,95	149
4652-10-600	7314150385188	1	32,06	149
4652-11-160	7314150385195	1	9,12	149
4652-11-260	7314150385218	1	14,15	149
4652-12-1000	7314150385287	1	79,30	150
4652-12-160	7314150385225	1	7,32	149
4652-12-160-10P	7314150475339	1	73,20	149
4652-12-210	7314150385232	1	9,33	149
4652-12-210-10P	7314150475360	1	93,28	149
4652-12-260	7314150385249	1	13,31	149
4652-12-310	7314150385256	1	17,70	149
4652-12-450	7314150385263	1	20,85	150
4652-12-600	7314150385270	1	33,21	150
4652-13-310	7314150385300	1	17,17	150
4652-14-1000	7314150385379	1	86,21	150
4652-14-160	7314150385317	1	10,06	150
4652-14-210	7314150385324	1	14,71	150
4652-14-260	7314150385331	1	17,70	150
4652-14-310	7314150385348	1	18,65	150
4652-14-450	7314150385355	1	24,51	150
4652-14-600	7314150385362	1	36,35	150
4652-15-260	7314150385393	1	18,33	150
4652-16-1000	7314150385478	1	97,94	150
4652-16-210	7314150385416	1	17,08	150
4652-16-260	7314150385423	1	18,44	150
4652-16-310	7314150385430	1	19,69	150
4652-16-450	7314150385447	1	29,11	150
4652-16-600	7314150385454	1	39,17	150
4652-18-1000	7314150385515	1	100,67	150
4652-18-200	7314150385485	1	21,90	150
4652-18-300	7314150385492	1	29,23	150
4652-18-450	7314150385508	1	33,31	150
4652-20-1000	7314150385560	1	101,60	150
4652-20-200	7314150385522	1	30,49	150
4652-20-300	7314150385539	1	34,26	150
4652-20-450	7314150385546	1	43,15	150
4652-20-600	7314150385553	1	63,90	150
4652-22-1000	7314150385607	1	102,65	150
4652-22-250	7314150385577	1	39,17	150
4652-22-450	7314150385584	1	54,46	150
4652-22-600	7314150385591	1	65,26	150
4652-24-250	7314150385614	1	45,57	150
4652-24-450	7314150385621	1	59,29	150

			€	
4652-25-1000	7314150385652	1	114,17	150
4652-25-250	7314150385638	1	49,44	150
4652-25-450	7314150385645	1	63,47	150
4652-26-250	7314150385669	1	61,80	150
4652-26-450	7314150385676	1	70,18	150
4652-3-110	7314150475216	50	8,38	149
4652-3,5-110	7314150475223	50	8,38	149
4652-4-110	7314150384365	1	5,76	149
4652-4-160	7314150384372	1	6,91	149
4652-5-110	7314150384815	1	4,17	149
4652-5-110-10P	7314150475247	1	41,78	149
4652-5-160	7314150384839	1	5,45	149
4652-5-160-10P	7314150475278	1	54,46	149
4652-5-210	7314150384846	1	8,59	149
4652-5,5-110	7314150384853	1	4,93	149
4652-5,5-110-10P	7314150475254	10	49,29	149
4652-5,5-160	7314150384860	1	6,19	149
4652-5,5-160-10P	7314150475285	1	61,86	149
4652-5,5-210	7314150475230	50	8,38	149
4652-6-110	7314150384877	1	4,30	149
4652-6-110-10P	7314150475261	1	43,01	149
4652-6-160	7314150384891	50	5,03	149
4652-6-160-10P	7314150475292	1	50,28	149
4652-6-210	7314150384907	1	8,17	149
4652-6-260	7314150384969	1	10,46	149
4652-6,5-110	7314150384976	1	4,93	149
4652-6,5-160	7314150384990	1	5,76	149
4652-6,5-160-10P	7314150475308	1	57,67	149
4652-7-110	7314150385003	1	6,19	149
4652-7-160	7314150391981	1	6,61	149
4652-8-110	7314150385034	1	5,14	149
4652-8-160	7314150385058	1	5,45	149
4652-8-160-10P	7314150475315	1	54,46	149
4652-8-210	7314150385065	1	7,32	149
4652-8-210-10P	7314150475346	1	73,20	149
4652-8-260	7314150385072	1	10,37	149
4652-8-460	7314150385089	1	21,90	149
4652-9-160	7314150385096	1	8,28	149
4652-9-210	7314150385102	1	9,01	149
4652-SET-5	7314150475377	1	18,48	150
4652-SET-7	7314150475384	1	28,83	150
4655-FLAT-250	7314150387823	1	11,11	151
4655-HOLLOW-240	7314150387847	1	22,83	151
4655-POINT-250	7314150387816	1	11,11	151
4655-SLOT-25032	7314150387885	1	146,64	151
4655-TILE-20040	7314150387861	1	21,58	151
4655-WIDE-20040	7314150387830	1	18,85	151
4655-WING-C-250	7314150387854	1	54,99	151
4656-12-340	7314150386932	1	63,38	148
4656-12-540	7314150387021	1	74,36	148
4656-14-340	7314150387069	1	68,08	148
4656-14-540	7314150387076	1	78,04	148
4656-15-340	7314150387083	1	78,56	148
4656-16-1320	7314150387137	1	272,33	148
4656-16-340	7314150387106	1	81,18	148
4656-16-540	7314150387113	1	84,84	148
4656-16-940	7314150387120	1	157,11	148
4656-18-1320	7314150387175	1	288,04	148
4656-18-340	7314150387144	1	83,28	148
4656-18-540	7314150387151	1	99,51	148
4656-18-940	7314150387168	1	151,88	148
4656-20-1320	7314150387212	1	340,41	148
4656-20-320	7314150387182	1	78,56	148
4656-20-520	7314150387199	1	101,60	148
4656-20-920	7314150387205	1	144,54	148
4656-22-1320	7314150387250	1	366,60	148
4656-22-320	7314150387229	1	96,36	148
4656-22-520	7314150387236	1	115,21	148
4656-22-920	7314150387243	1	157,11	148
4656-24-320	7314150387267	1	93,23	148
4656-24-520	7314150387274	1	115,21	148
4656-25-1320	7314150387311	1	396,98	148
4656-25-320	7314150387281	1	102,65	148
4656-25-520	7314150387298	1	125,69	148
4656-25-920	7314150387304	1	186,44	148
4656-26-520	7314150387328	1	125,69	148
4656-28-370	7314150387434	1	123,59	148
4656-28-570	7314150387458	1	135,12	148
4656-28-670	7314150387489	1	170,73	148
4656-28-920	7314150387526	1	204,25	148
4656-30-370	7314150387540	1	135,12	148
4656-30-570	7314150387571	1	144,54	148
4656-32-1320	7314150387649	1	408,49	148
4656-32-370	7314150387595	1	141,41	148
4656-32-570	7314150387618	1	175,97	148
4656-32-920	7314150387632	1	239,86	148
4656-35-370	7314150387656	1	156,07	148
4656-35-570	7314150387663	1	187,49	148
4656-35-670	7314150387670	1	219,96	148
4656-37-370	7314150387687	1	157,11	148
4656-37-570	7314150387694	1	187,49	148
4656-37-920	7314150387700	1	282,80	148
4656-38-370	7314150387717	1	272,33	148
4656-38-570	7314150387724	1	187,49	148
4656-40-1320	7314150387762	1	492,29	148
4656-40-370	7314150387731	1	183,30	148

			€	
4656-40-570	7314150387748	1	225,20	148
4656-40-920	7314150387755	1	293,28	148
4656-45-570	7314150387779	1	303,75	148
4656-45-920	7314150387786	1	417,92	148
4656-50-570	7314150387793	1	366,60	148
4656-52-570	7314150387809	1	429,44	148
4659-FLAT -28	7314150387922	1	17,29	151
4659-FLAT -40	7314150387939	1	20,01	151
4659-FLAT -60	7314150387946	1	25,98	151
4659-POINT-28	7314150387892	1	16,76	151
4659-POINT-40	7314150387908	1	20,01	151
4659-POINT-60	7314150387915	1	27,03	151
4659-TILE-30-5	7314150388042	1	47,35	151
4659-TILE-30-8	7314150388059	1	49,76	151
4659-WIDE-30-8	7314150387953	1	44,83	151
4659-WIDE-36-5	7314150387984	1	29,86	151
466-1000	7314150128327	4	48,11	539
466-1000-M	7314150186105	4	59,61	539
466-1200	7314150128334	4	58,24	539
466-1200-M	7314150186129	4	70,94	539
466-1800	7314150128341	4	75,11	539
466-2000	7314150129836	4	91,62	539
466-250	7314150128655	10	29,24	541
466-400	7314150128297	4	32,59	539
466-400-M	7314150128358	4	40,96	539
466-600	7314150128303	4	39,67	539
466-600-M	7314150128365	4	48,12	539
466-800	7314150128310	4	43,03	539
466-800-M	7314150186082	4	52,00	539
466-BE1	7314150215218	12	6,43	541
466-LINE	7314150215249	12	5,34	541
466-POST	7314150215232	6	9,02	541
4724-JT	7311518265847	1	17,63	635
4728-JT	7311518265854	1	18,21	635
474-125-0-60	7311518029050	10	9,86	549
474-125-0-80	7311518029869	10	10,01	549
474-150-0-60	7311518029876	10	10,35	549
474-150-0-80	7311518029883	10	10,52	549
4750-2PP-1	7314153014733	1	45,05	469
4750-3PB-2	7314150187782	1	129,33	474
4750-BWC-1	7314153018809	1	29,08	469
4750-DHO-3	7314150289530	1	34,27	469
4750-EP-1	7314153014726	1	56,64	469
4750-FOLTC-1	7314153019271	1	171,29	467
4750-HDB-2	7314150289486	1	51,11	468
4750-HDBS-2	7314150289479	1	162,30	468
4750-HDLB-1	7314153014757	1	32,02	468
4750-HDLB-TAH	7314150303892	1	61,58	474
4750-HHO-2	7314153014863	1	21,47	474
4750-JU3PB-1	7314153015747	1	35,63	468
4750-KNHO-1	7314153015839	1	18,21	469
4750-KP-1	7314153014771	1	44,43	469
4750-LV-1	7314150358052	1	10,86	467
4750-LV-2	7314150393800	1	10,87	467
4750-MPH-1	7314150291625	1	28,03	469
4750-QRFB-1	7314150289455	1	21,25	468
4750-ROCO-1	7314153015273	1	20,70	469
4750-TOCST-1	7314153018779	1	64,74	467
4750-UP-2	7314150187768	1	60,79	474
4750-VDEC	7314150222377	1	252,79	468
4750-VMPH-1	7314153014818	1	22,40	469
4750ALC01FF1	7314150508884	1	808,55	440
4750BMC10	7314150264032	1	22,43	463
4750BMC10FF1	7314150500673	1	494,40	462
4750BMC3	7314150359639	1	5,06	463
4750BMC4	7314150426256	1	9,11	463
4750BMC5	7314150264001	1	12,39	463
4750BMC5,5	7314150326167	1	13,75	463
4750BMC6	7314150264018	1	15,93	463
4750BMC7	7314150277605	1	16,41	463
4750BMC9	7314150264025	1	16,76	463
4750BMC9,5	7314150326174	1	21,13	463
4750BMC1	7314150541294	1	30,80	421
4750FB1-19A	7314150277612	1	78,60	466
4750FB1-19B	7314150277629	4	107,25	466
4750FB2-19A	7314150277636	4	64,91	466
4750FB2-19TS001	7314150302772	1	560,68	463
4750FB2-24A	7314150277643	2	97,51	466
4750FB2W-24A	7314150277650	1	192,45	466
4750FB2W-TS001	7314150302765	1	670,28	463
4750FB3-12	7314150277667	1	79,72	466
4750FB4-18	7314150277674	4	109,64	466
4750FB4-18TS001	7314150302758	1	745,29	464
4750FB5-FG1	7314150401796	1	19,11	467
4750FB5-FG2	7314150401819	1	22,10	467
4750FB5A	7314150277704	1	10,63	467
4750FB5ATS001	7314150302727	1	131,76	465
4750FB5B	7314150277698	1	18,67	467
4750FB5BFF1	7314150302734	1	194,78	465
4750FB5C	7314150277681	8	24,36	467
4750FB6-13	7314150393091	1	19,20	466
4750FB6-19	7314150393114	1	26,09	467
4750FB7-01	7314150465668	60	22,23	468
4750FB7-02	7314150465675	60	26,29	468
4750FB7ORBG	7314150465682	120	8,99	468
4750FB7ORLT	7314150465699	120	7,85	468



4750FB8



4750FB8	7314150465651	4	100,73	465
4750PTB50	7314150275007	3	48,15	463
4750PTB60	7314150275014	3	55,38	463
4750PTB65	7314150345809	2	62,17	463
4750PTB65TS5	7314150456260	1	223,43	462
4750PTBW47	7314150275021	1	78,26	462
4750PTBW67	7314150289189	1	98,73	462
4750RC01	7314150220151	1	216,87	443
4750RC02	7314150220168	1	257,53	443
4750RC021	7314150226641	1	292,82	443
4750RCHD-AC1	7314150229857	1	37,97	444
4750RCHD00	7314150271603	1	222,13	443
4750RCHD01	7314150227426	1	281,55	442
4750RCHD011	7314150229802	1	458,35	443
4750RCHD01AC1	7314150229819	1	52,38	444
4750RCHD01AC2	7314150229826	1	124,42	444
4750RCHD01FF1	7314150247578	1	2.749,85	440
4750RCHDW01	7314150227433	1	325,43	442
4750RCHDW01AC1	7314150229833	1	52,38	444
4750RCHDW01AC2	7314150229840	1	124,42	444
4750RCHDW01FF1	7314150247561	1	4.150,39	439
4750RCHDW01FF2	7314150249183	1	2.999,37	439
4750RCHDW01FF3	7314150249190	1	2.671,03	439
4750RCHDW01FF4	7314150309580	1	1.876,90	440
4750RCHDW01FF9	7314150345533	1	2.834,84	440
4750RCHDW01RED	7314150407538	1	325,43	442
4750RCHDW02	7314150227440	1	510,75	442
4750RCHDW02FF1	7314150267422	1	2.492,05	437
4750RCHDW02FF15	7314150347698	1	3.661,68	439
4750RCHDW02FF2	7314150306787	1	2.807,14	438
4750RCHDW02FF4	7314150309559	1	3.959,33	438
4750RCHDW02RED	7314150407545	1	510,75	442
4750RCHDW02RF1V	7314150422081	1	3.036,30	437
4750RCHDW10	7314150425587	1	687,46	442
4750RCW01	7314150220182	1	515,07	443
4750RCW011	7314150226627	1	554,61	443
4750RCWD-AC1	7314150277179	1	80,21	443
4750RCWD-AC2	7314150277186	1	74,04	443
4750RCWD-AC3	7314150277193	1	74,04	443
4750RCWD-AC4	7314150277209	1	55,54	443
4750RCWD4	7314150277124	1	777,48	442
4750RCWD4-OR	7314150409501	1	777,48	442
4750RCWD4FF1	7314150302413	1	2.183,69	436
479-08	7311518025441	6	18,34	593
479-12	7311518025458	6	19,56	593
479-16	7311518025465	6	22,40	593
479-20	7314150319862	6	23,98	593
479-24	7311518025472	6	25,65	593
479-32	7311518025489	6	27,70	593
479F-08	7314150441952	6	21,22	593
479F-12	7314150441976	6	22,51	593
479F-16	7314150441983	6	25,76	593
479F-20	7314150441990	6	27,58	593
479F-24	7314150442003	6	29,50	593
479F-32	7314150442010	6	31,85	593
480-08	7311518025496	4	23,05	594
480-10	7311518025502	6	24,92	594
480-12	7311518025519	6	26,93	594
480-14	7311518025526	4	36,80	594
480-20	7314150319763	4	30,29	594
481-100	7311518005030	6	12,38	593
481-1000	7311518005092	6	30,52	593
481-1500	7311518025533	6	41,67	593
481-200	7311518005047	6	13,89	593
481-2000	7314150319855	6	61,34	593
481-300	7311518005054	6	16,38	593
481-400	7311518005061	6	18,10	593
481-500	7311518005078	6	20,82	593
481-800	7311518025540	6	27,77	593
481F-100	7314150442072	6	14,24	593
481F-1000	7314150442133	6	35,09	593
481F-1500	7314150442140	4	47,92	593
481F-200	7314150442089	4	15,97	593
481F-2000	7314150442157	4	70,55	593
481F-300	7314150442096	6	18,84	593
481F-400	7314150442102	6	20,82	593
481F-500	7314150442119	6	23,94	593
481F-800	7314150442126	6	31,94	593
482-25	7311518025557	6	16,08	593
482-28	7311518025564	6	17,51	593
482-30	7311518025571	6	20,35	593
482-35	7311518025595	6	23,90	593
482-40	7311518025601	6	26,50	593
482-45	7311518027551	6	27,74	593
482F-25	7314150442225	4	18,50	593
482F-28	7314150442232	4	20,14	593
482F-30	7314150442249	6	23,41	593
482F-35	7314150442256	4	27,49	593
482F-40	7314150442263	2	30,47	593
482F-45	7314150442270	4	31,89	593
483-16	7311518024314	6	9,93	594
483-20	7311518024321	6	11,05	594
483-22	7311518005108	6	11,96	594
483-25	7311518005115	6	13,48	594
483-28	7311518024284	6	14,98	594
4830	7314150100057	3	42,75	242



4831	7314150103393	3	45,46	242
4833	7314150100064	3	47,00	243
483F-16	7314150442164	6	11,42	594
483F-20	7314150442171	6	12,71	594
483F-22	7314150442188	6	13,76	594
483F-25	7314150442195	6	15,50	594
483F-28	7314150442201	6	17,22	594
483F-30	7314150442218	4	18,81	594
484-1000	7311518005122	6	30,48	594
484-1250	7311518005139	6	34,48	594
484-1500	7311518005146	6	39,01	594
484-2000	7311518024338	4	42,98	594
484F-1000	7314150442027	6	35,05	594
484F-1250	7314150442034	6	39,65	594
484F-1500	7314150442041	6	44,86	594
484F-2000	7314150442058	4	49,42	594
485	7311518005153	6	31,37	594
485W-650	7314150319770	6	28,74	594
485W-750	7314150319787	6	30,48	594
486	7311518005160	4	30,26	595
486-1800	7314150315307	5	58,84	541
486-1800WH	7314150315338	5	58,84	541
486-2000	7314150315314	5	64,52	541
486-2000WH	7314150315345	5	64,52	541
486-2400	7314150315321	5	75,73	541
486-2400WH	7314150315352	5	75,73	541
486-700	7314150338078	6	22,92	595
486F-700	7314150338085	6	29,37	595
486W-500	7314150319794	4	23,05	595
486W-600	7314150319800	4	23,75	595
488-2000	7314150337972	2	35,22	595
488-3000	7314150337989	2	42,58	595
488-4000	7314150337996	2	49,35	595
488-5000	7314150338009	2	59,03	595
488-6000	7314150338016	1	64,87	595
488F-2000	7314150338023	2	39,67	595
488F-3000	7314150338030	2	46,29	595
488F-4000	7314150338047	2	52,40	595
488F-5000	7314150338054	4	62,21	595
488F-6000	7314150338061	2	67,52	595
489-1100	7314150133055	8	111,08	597
489-1800	7314150133062	8	111,43	597
489-2700	7314150133079	4	209,03	597
489-3600	7314150133086	4	249,00	597
489-4500	7314150133093	4	269,65	597
489-5400	7314150133109	4	299,95	597
490-3.5	7311518025373	4	22,22	594
491-3000	7314150345199	4	36,89	597
491-4000	7314150345205	4	41,08	597
491-5000	7314150345212	4	48,55	597
491-6000	7314150345229	4	53,67	597
492-3.5	7311518025380	6	28,49	594
493-500	7314150338139	6	22,88	596
493-600	7314150338146	6	24,54	596
493F-500	7314150338153	6	27,44	596
493F-600	7314150338160	1	29,85	596
494-600	7311518025397	4	31,21	596
495-500	7314150338191	6	23,35	596
495-600	7314150338207	6	24,34	596
495F-500	7314150338184	6	26,72	596
495F-600	7314150338177	1	29,37	596
496-1500	7314150315147	5	73,42	541
496-1800	7314150315154	5	85,67	541
496-SPARE	7314150329304	1	7,46	542
4M-10-11	7314151829438	10	11,19	53
4M-12-13	7314151829445	10	12,23	53
4M-14-15	7314151829476	10	13,41	53
4M-16-17	7314151829490	10	14,42	53
4M-17-19	7314151829506	10	14,99	53
4M-18-19	7314151829513	10	14,99	53
4M-20-22	7314151829520	10	17,31	53
4M-21-23	7314150205363	5	18,96	53
4M-24-26	7314150205370	1	21,27	53
4M-24-27	7314151829551	1	21,27	53
4M-25-28	7314150205387	1	24,03	53
4M-27-29	7314150205394	1	28,83	53
4M-30-32	7314151829575	1	30,30	53
4M-6-7	7314151829407	10	9,75	53
4M-8-9	7314151829414	10	10,07	53
4M/10C	7314150212972	1	161,00	53
4M/10T	7314151829605	1	178,83	53
4M/12C	7314150212989	1	216,17	54
4M/8	7314150180493	1	120,17	54
5-600-21-D-1P	7311518189341	10	136,96	35
5-610-21-D-1P	7311518189358	5	135,88	35
5-630-21-D-1P	7311518189365	1	97,03	35
5-670-21-D-1P	7311518189389	1	144,08	35
500-12	7314150390977	1	120,53	270
500-14	7314150414505	1	129,22	270
500-15	7314150390984	1	133,23	270
500-16	7314150414512	1	139,57	270
500-18	7314150414543	1	164,33	270
500-22	7314150414567	1	188,31	270
502	7311518130589	25	10,03	566
502-SET2	7311518130664	35	5,82	566
502-SET6	7311518130633	10	26,06	566

			€	
5050	7314151083359	1	101,06	360
51-12	7311518044565	10	3,58	634
51-21	7311518003906	10	4,83	634
51-24	7311518003913	10	5,16	634
51-30	7311518003920	10	5,78	634
51-32	7311518003937	10	6,00	634
51-36	7311518003944	10	6,23	634
510031	7314150216338	5	37,03	215
510033	7314150216345	5	24,41	215
510034	7314150216314	10	17,37	214
5124-JS-H	7311518219352	4	51,03	635
5128-JS-H	7311518219369	4	57,25	635
52	7311518276027	12	4,33	308
5226 DC	7314150120352	1	54,75	248
527 D-160	7314150032723	5	26,42	236
527 D-200	7314150032730	5	31,56	236
527 GC-160	7314150205653	3	32,93	236
527 GC-200	7314150205660	3	39,32	236
527V-160	7314150126811	2	48,74	499
527V-200	7314150126828	2	53,47	499
528-700	7311518188993	1	48,52	573
528-COM	7311518188986	1	40,60	573
529-16-L	7314150198139	4	38,64	592
529-16-XL	7314150198146	4	40,72	592
529-20-L	7314150198160	4	40,72	592
529-20-XL	7314150198153	4	42,78	592
529S-16-XL	7314150340330	4	39,73	592
529S-20-XL	7314150340347	4	41,74	592
541 D-150	7314150032754	5	16,62	237
541 D-200	7314150032761	5	18,89	237
541 D-250	7314150032778	5	24,77	237
5418	7314151084370	1	46,79	536
5419/6T	7314151821562	1	54,70	536
541D-180	7314150127160	5	17,81	237
541D-225	7314150127290	5	21,77	237
5463 R	7314151085063	5	56,96	534
5463-120	7314151085001	5	34,03	534
54640	7314150215720	1	19,58	169
5465 AMT	7314151085148	5	56,96	532
5465 R	7314151085162	5	54,08	534
5468-112	7314151085247	5	26,06	532
5469 B	7314151085322	5	24,46	532
5469 BI	7314151085346	5	26,18	532
5469 I	7314151085407	5	28,45	532
5469 R	7314151085421	5	39,43	532
5469-127	7314151085285	5	25,32	532
5470-120	7314151085452	5	21,66	534
5471 F-120	7314151085681	5	20,91	532
5471 F-145	7314151085704	5	22,66	532
5471 F-200	7314151085728	5	46,01	532
5471 F-250	7314151085742	5	58,83	532
5471 F-300	7314151085766	5	80,87	532
5471 FI-120	7314151085780	5	22,02	532
5471 FI-200	7314151085827	5	44,29	532
5471 FR-120	7314151085889	5	36,01	532
5471 FR-145	7314151085902	5	40,85	532
5475 K	7314151086244	5	27,25	532
5475 R	7314151086268	5	49,47	532
5476 H	7314151086305	5	63,96	534
5479-130	7314151086398	5	18,88	532
5488 AM	7314151821166	5	41,77	533
5489 AM	7314151821173	5	41,77	533
5490 AM	7314151821180	5	41,77	533
5493-115	7314151821234	5	66,50	534
5515B	7314151086978	25	25,74	361
5515FL	7314150504077	10	38,05	361
5515FUV	7314150540143	1	50,55	361
5515GV	7314151481483	1	35,72	360
5515L	7314151481568	1	27,16	361
5515M	7314151086985	1	35,59	361
5515T	7314151589172	25	31,44	361
5515T-52	7314153021939	25	13,37	360
5516	7314151086992	5	24,03	532
5516 I	7314151087029	5	26,36	532
5517	7314151573843	5	27,78	532
5517 I	7314151573928	5	27,23	532
5518	7314151087043	5	30,35	532
5521	7314150215713	1	53,14	169
5540 AM	7314151821319	5	41,77	532
5541 AM	7314151821326	5	41,77	533
5544 AM	7314151821357	5	41,77	533
5545 AM	7314151821364	5	41,77	533
5546 AM	7314151821371	5	41,77	533
5547 AM	7314151821388	5	41,77	533
5549 AM	7314151821401	5	41,77	533
5550-3.2	7314151475673	10	18,16	536
5550-4.5	7314151475758	10	21,13	536
5551	7314151378479	1	19,62	536
5552	7314151378554	1	19,62	536
5553	7314151378639	1	19,62	536
5554	7314151378714	1	19,62	536
5568/5	7314151821210	1	222,68	534
5573-145	7314151473112	5	63,67	533
5577-145	7314151574062	5	64,38	534
5578-115	7314151547769	5	45,20	533
5579-115	7314151547844	5	45,20	533

			€	
5588 AM	7314151821432	5	41,77	534
5589 AM	7314151821449	5	41,77	534
5590 AM	7314151821456	5	41,77	534
5600/4	7314151436773	1	91,66	536
5724-JS	7311518216085	1	34,24	635
5728-JS	7311518216092	1	39,31	635
5750	7311518280949	1	18,30	343
5770	7314150504466	12	73,81	343
583D	7314150023721	4	87,80	577
584D	7314150023745	4	84,63	577
585D	7314150104185	4	84,55	577
586D	7314150104208	4	82,17	577
59/S100BC	7314150337637	1	45,25	167
59/S100BC-IP	7314150337644	8	45,25	167
59/S100C	7314150413003	1	4,52	165
59/S28-4	7314151847173	1	117,33	166
59/S31B	7314150325788	1	15,71	166
59/S31B-IP	7314150325795	12	15,40	166
59/S35BC	7314150412990	1	64,35	167
59/S36BCR	7314150413232	6	54,53	211
59/S54BC	7314150337613	1	34,56	167
59/S54BC-IP	7314150337620	8	34,56	167
59S/0.5-3.0	7314150199815	1	12,68	160
59S/0.5-3.0-3P	7314150259205	1	3,81	160
59S/0.5-4.0	7314150199822	1	12,68	160
59S/0.5-4.0-3P	7314150259212	1	3,81	160
59S/0.6-3.5	7314150199839	1	12,68	160
59S/0.6-3.5-3P	7314150259229	1	3,81	160
59S/0.6-4.5	7314150198801	1	12,68	160
59S/0.6-4.5-3P	7314150201600	1	3,81	160
59S/0.8-5.5	7314150198849	1	12,68	160
59S/0.8-5.5-3P	7314150201624	1	3,81	160
59S/1.0-5.5	7314150198863	1	12,68	160
59S/1.0-5.5-3P	7314150259963	1	3,81	160
59S/1.2-6.5	7314150198887	1	12,68	160
59S/1.2-6.5-3P	7314150259970	1	3,81	160
59S/1.2-8.0	7314150198900	1	20,60	160
59S/1.2-8.0-3P	7314150259987	1	6,19	160
59S/1.6-1.0	7314150199846	1	20,60	160
59S/1.6-1.0-3P	7314150259236	1	6,19	160
59S/1.6-9.0	7314150199853	1	20,60	160
59S/1.6-9.0-3P	7314150259243	1	6,19	160
59S/125PH1	7314150206834	1	34,36	164
59S/125PH1-2P	7314150260553	1	13,74	164
59S/125PH2	7314150204298	1	34,36	164
59S/125PH2-2P	7314150260560	1	13,74	164
59S/125PH2-IP	7314150342433	100	2,58	164
59S/125PH3	7314150204304	1	34,36	164
59S/125PH3-2P	7314150260577	1	13,74	164
59S/125PZ1	7314150200733	1	34,36	164
59S/125PZ1-2P	7314150260522	1	13,74	164
59S/125PZ2	7314150200740	1	34,36	164
59S/125PZ2-2P	7314150260539	1	13,74	164
59S/125PZ3	7314150200757	1	34,36	164
59S/125PZ3-2P	7314150260546	1	13,74	164
59S/150T15	7314150200764	1	51,53	164
59S/150T15-2P	7314150260584	1	20,61	164
59S/150T20	7314150200771	1	51,53	164
59S/150T20-2P	7314150260591	1	20,61	164
59S/150T25	7314150200788	1	51,53	164
59S/150T25-2P	7314150260607	1	20,61	164
59S/150T30	7314150200795	1	51,53	164
59S/150T30-2P	7314150260614	1	20,61	164
59S/17-1	7314150191499	1	21,69	165
59S/17-2	7314150191505	1	22,67	166
59S/17-3	7314150191512	1	21,99	166
59S/22-1	7314150204229	1	30,77	166
59S/22-2	7314150204236	1	30,77	166
59S/31-1	7314150191451	1	24,04	166
59S/31-2	7314150191468	1	24,72	167
59S/31-3	7314150191475	1	28,88	167
59S/50/0.6-3.5	7314150199976	1	17,17	162
59S/50/0.8-4.0	7314150200009	1	17,17	162
59S/50/0.8-5.5	7314150200023	1	17,17	162
59S/50/1.0-6.0	7314150200047	1	17,17	162
59S/50/1.2-6.5	7314150200061	1	17,17	162
59S/50/3.5-2P	7314150260027	1	6,87	162
59S/50/4.0-2P	7314150260041	1	6,87	162
59S/50/5.5-2P	7314150260065	1	6,87	162
59S/50/6.0-2P	7314150260089	1	6,87	162
59S/50/6.5-2P	7314150260102	1	6,87	162
59S/50H1/16	7314150248926	1	20,48	163
59S/50H1/4	7314150249015	1	20,48	163
59S/50H1/8	7314150248964	1	20,48	163
59S/50H2	7314150200160	1	21,14	163
59S/50H2-2P	7314150259298	1	5,28	163
59S/50H2.5-5P	7314150531653	1	8,75	163
59S/50H2.5-2P	7314150259304	1	5,28	163
59S/50H3	7314150200184	1	21,14	163
59S/50H3-2P	7314150259335	1	5,28	163
59S/50H3/16	7314150248995	1	20,48	163
59S/50H3/32	7314150248940	1	20,48	163
59S/50H3/8	7314150249039	1	20,48	163
59S/50H4-5P	7314150531691	1	8,75	163
59S/50H4-2P	7314150259359	1	5,28	163
59S/50H5-5P	7314150531714	1	8,75	163



59S/50H5-2P



59S/50H5-2P	7314150259373	1	5,28	163
59S/50H5/16	7314150249022	1	20,48	163
59S/50H5/32	7314150248988	1	20,48	163
59S/50H5/64	7314150248933	1	20,48	163
59S/50H6	7314150200214	1	21,14	163
59S/50H6-2P	7314150259397	1	5,28	163
59S/50H7/32	7314150249008	1	20,48	163
59S/50H7/64	7314150248957	1	20,48	163
59S/50H8-2P	7314150259410	1	5,28	163
59S/50H8-5P	7314150531752	1	21,14	163
59S/50H9/64	7314150248971	1	20,48	163
59S/50PH1	7314150199860	1	13,88	162
59S/50PH1-2P	7314150203642	1	6,88	162
59S/50PH2-5P	7314150531790	1	8,75	162
59S/50PH2-2P	7314150203758	1	6,88	162
59S/50PH3-2P	7314150203802	1	6,88	162
59S/50PH3-5P	7314150531813	1	13,88	162
59S/50PZ1-2P	7314150204007	1	6,88	163
59S/50PZ2-2P	7314150204014	1	6,88	163
59S/50PZ2-5P	7314150531851	1	13,88	163
59S/50PZ3-2P	7314150204021	1	6,88	163
59S/50PZ3-5P	7314150531875	1	13,88	163
59S/50R1	7314150200238	1	27,74	163
59S/50R1-2P	7314150259441	1	11,11	163
59S/50R2	7314150200245	1	27,74	163
59S/50R2-2P	7314150259472	1	11,11	163
59S/50R3	7314150200252	1	27,74	163
59S/50R3-2P	7314150259502	1	11,11	163
59S/50T10	7314150200092	1	18,49	163
59S/50T10-2P	7314150201723	1	9,78	163
59S/50T15	7314150200108	1	18,49	163
59S/50T15-2P	7314150201730	1	9,78	163
59S/50T20-5P	7314150531936	1	9,30	163
59S/50T20-2P	7314150201747	1	9,78	163
59S/50T25	7314150200122	1	18,49	163
59S/50T25-2P	7314150201754	1	9,78	163
59S/50T27	7314150200139	1	18,49	163
59S/50T30	7314150200146	1	18,49	163
59S/50T30-2P	7314150201761	1	9,78	163
59S/50T40	7314150200153	1	18,49	163
59S/50T40-2P	7314150259281	1	9,78	163
59S/50T8	7314150200085	1	18,49	163
59S/50T8-2P	7314150262809	1	9,78	163
59S/60PEN/DISP	7314150459032	1	184,31	168
59S/7-1	7314150191536	1	12,39	165
59S/7-2	7314150191543	1	13,08	165
59S/7-3	7314150191550	1	23,19	165
59S/7-4	7314150191567	1	13,54	165
59S/70PH1-2P	7314150259526	1	9,25	163
59S/70PH2-2P	7314150259557	1	9,25	163
59S/70PH2-5P	7314150532032	1	23,12	163
59S/70PZ1	7314150200283	1	23,12	163
59S/70PZ1-2P	7314150259564	1	9,25	163
59S/70PZ2	7314150200290	1	23,12	163
59S/70PZ2-2P	7314150260331	1	9,25	163
59S/70PZ3	7314150200306	1	23,12	163
59S/70PZ3-2P	7314150260348	1	9,25	163
59S/70T10	7314150200313	1	27,74	163
59S/70T10-2P	7314150260355	1	11,11	163
59S/70T15	7314150200566	1	27,74	163
59S/70T15-2P	7314150260362	1	11,11	163
59S/70T20-2P	7314150201839	1	11,11	163
59S/70T20-5P	7314150532131	1	27,74	163
59S/70T25-2P	7314150260379	1	11,11	163
59S/70T25-5P	7314150532155	1	27,74	163
59S/70T27	7314150200597	1	27,74	163
59S/70T27-2P	7314150260386	1	11,11	163
59S/70T30-2P	7314150260393	1	11,11	163
59S/70T30-5P	7314150532179	1	27,74	163
59S/70T40	7314150200610	1	27,74	163
59S/70T40-2P	7314150260409	1	11,11	163
59S/70TR15	7314150200627	1	40,95	164
59S/70TR15-2P	7314150260416	1	16,37	164
59S/70TR20	7314150200634	1	40,95	164
59S/70TR20-2P	7314150260423	1	16,37	164
59S/70TR25	7314150200641	1	40,95	164
59S/70TR25-2P	7314150260430	1	16,37	164
59S/70TR27	7314150200658	1	40,95	164
59S/70TR27-2P	7314150260447	1	16,37	164
59S/70TR30	7314150200665	1	40,95	164
59S/70TR30-2P	7314150260454	1	16,37	164
59S/70TR40	7314150200672	1	40,95	164
59S/70TR40-2P	7314150260461	1	16,37	164
59S/H1.5	7314150198924	1	13,19	161
59S/H1.5-3P	7314150258994	1	7,93	161
59S/H1/16-3P	7314150259021	1	7,93	162
59S/H1/4	7314150199266	1	13,19	162
59S/H1/4-3P	7314150259120	1	7,93	162
59S/H1/8-3P	7314150259069	1	7,93	162
59S/H1/8-5P	7314150532254	1	13,19	162
59S/H10	7314150199075	1	17,17	161
59S/H10-3P	7311518333638	1	10,31	161
59S/H2	7314150198955	1	13,19	161
59S/H2-3P	7314150259007	1	7,93	161
59S/H2.5	7314150198962	1	13,19	161
59S/H2.5-3P	7314150259014	1	7,93	161



59S/H3	7314150198986	1	13,19	161
59S/H3-3P	7314150201662	1	9,53	161
59S/H3/16-3P	7314150259090	1	7,93	162
59S/H3/16-5P	7314150532353	1	13,19	162
59S/H3/32-3P	7314150259045	1	7,93	162
59S/H3/32-5P	7314150532377	1	13,19	162
59S/H3/8	7314150204212	1	7,93	162
59S/H3/8-3P	7314150259144	1	10,31	162
59S/H3BALL	7314150200689	1	40,95	164
59S/H3BALL-2P	7314150260478	1	16,37	164
59S/H4	7314150198993	1	13,19	161
59S/H4-3P	7314150201679	1	9,53	161
59S/H4-IPB	7314150225767	500	0,62	161
59S/H4BALL	7314150200696	1	40,95	164
59S/H4BALL-2P	7314150260485	1	16,37	164
59S/H5	7314150199013	1	13,19	161
59S/H5-3P	7314150201686	1	9,53	161
59S/H5/16-3P	7314150259137	1	7,93	162
59S/H5/16-5P	7314150532438	1	13,19	162
59S/H5/32-3P	7314150259083	1	7,93	162
59S/H5/32-5P	7314150532452	1	13,19	162
59S/H5/64-3P	7314150259038	1	7,93	162
59S/H5/64-5P	7314150532476	1	13,19	162
59S/H5BALL	7314150200702	1	40,95	164
59S/H5BALL-2P	7314150260492	1	16,37	164
59S/H6	7314150199037	1	13,19	161
59S/H6-3P	7314150201693	1	9,53	161
59S/H6BALL	7314150200719	1	40,95	164
59S/H6BALL-2P	7314150260508	1	16,37	164
59S/H7/32-3P	7314150259113	1	7,93	162
59S/H7/32-5P	7314150532513	1	13,19	162
59S/H7/64-3P	7314150259052	1	7,93	162
59S/H7/64-5P	7314150532537	1	13,19	162
59S/H8-3P	7314150201709	1	10,31	161
59S/H8-5P	7314150532551	1	17,17	161
59S/H8BALL	7314150200726	1	40,95	164
59S/H8BALL-2P	7314150260515	1	16,37	164
59S/H9/64-3P	7314150259076	1	7,93	162
59S/HBALL-3P	7314150201716	1	24,51	164
59S/M3	7314150199730	1	34,36	162
59S/M3-3P	7314150259151	1	10,31	162
59S/M4	7314150199754	1	34,36	162
59S/M4-3P	7314150259168	1	10,31	162
59S/M5	7314150199778	1	34,36	162
59S/M5-3P	7314150259175	1	10,31	162
59S/M6	7314150199792	1	34,36	162
59S/M6-3P	7314150259182	1	10,31	162
59S/M8	7314150199808	1	38,31	162
59S/M8-3P	7314150259199	1	11,49	162
59S/PH0	7314150198177	1	6,62	160
59S/PH0-3P	7314150258819	1	2,54	160
59S/PH1-30P	7314150200801	1	18,56	160
59S/PH1-3P	7314150201396	1	3,31	160
59S/PH1-IP	7314150206780	100	0,52	160
59S/PH1-IPB	7314150225743	500	0,47	160
59S/PH1COMBI-2P	7314150215669	1	16,37	164
59S/PH2	7314150198320	1	6,62	160
59S/PH2-30P	7314150200818	1	18,56	160
59S/PH2-3P	7314150201402	1	3,31	160
59S/PH2-IP	7314150206797	100	0,52	160
59S/PH2-IPB	7314150204038	500	0,47	160
59S/PH2COMBI-2P	7314150203604	1	16,37	164
59S/PH2G-30P	7314150200832	1	35,44	160
59S/PH2G-3P	7314150259250	1	3,88	160
59S/PH2PEN	7314150458950	1	3,07	168
59S/PH3-30P	7314150200825	1	18,56	160
59S/PH3-3P	7314150201419	1	3,31	160
59S/PH3-IPB	7314150225750	500	0,47	160
59S/PH3COMBI-2P	7314150203611	1	16,37	164
59S/PH4	7314150198368	1	13,45	160
59S/PH4-3P	7314150258826	1	4,34	160
59S/PZ0	7314150198375	1	8,46	161
59S/PZ0-3P	7314150258833	1	2,54	161
59S/PZ1	7314150198382	1	6,62	161
59S/PZ1-30P	7314150200849	1	18,56	161
59S/PZ1-3P	7314150201426	1	3,31	161
59S/PZ1-IP	7314150206803	100	0,61	161
59S/PZ1-IPB	7314150204373	500	0,47	161
59S/PZ2-30P	7314150200856	1	18,56	161
59S/PZ2-3P	7314150201433	1	3,31	161
59S/PZ2-IP	7314150206810	100	0,52	161
59S/PZ2-IPB	7314150204380	500	0,47	161
59S/PZ2PEN	7314150458974	1	3,07	168
59S/PZ3	7314150198429	1	6,62	161
59S/PZ3-30P	7314150200863	1	18,56	161
59S/PZ3-3P	7314150201440	1	3,31	161
59S/PZ3-IPB	7314150225736	500	0,47	161
59S/PZ4	7314150198436	1	13,45	161
59S/R1	7314150199310	1	29,07	162
59S/R1-3P	7314150201631	1	11,64	162
59S/R2	7314150199341	1	29,07	162
59S/R2-3P	7314150201648	1	11,64	162
59S/R3	7314150199365	1	29,07	162
59S/R3-3P	7314150201655	1	11,64	162
59S/R4	7314150232109	1	29,07	162
59S/T10	7314150198528	1	11,11	161

			€	
59S/T10-30P	7314150200870	1	30,91	161
59S/T10-3P	7314150201457	1	5,55	161
59S/T10CS	7314150444014	1	9,00	161
59S/T15-10P	7314150532759	1	10,00	161
59S/T15-30P	7314150200887	1	30,91	161
59S/T15-3P	7314150201464	1	5,55	161
59S/T15CS	7314150444021	1	9,00	161
59S/T15PEN	7314150458929	1	3,58	168
59S/T20-30P	7314150200894	1	30,91	161
59S/T20-3P	7314150201471	1	5,55	161
59S/T20CS	7314150444038	1	9,00	161
59S/T20PEN	7314150458936	1	3,58	168
59S/T25	7314150198566	1	11,11	161
59S/T25-30P	7314150200900	1	30,91	161
59S/T25-3P	7314150201488	1	5,55	161
59S/T25CS	7314150444045	1	9,00	161
59S/T25PEN	7314150458943	1	3,58	168
59S/T27	7314150198580	1	11,11	161
59S/T27-3P	7314150201495	1	5,55	161
59S/T27CS	7314150444052	1	9,00	161
59S/T3	7314150198443	1	9,26	161
59S/T3-3P	7314150258840	1	5,55	161
59S/T30-10P	7314150251988	1	10,00	161
59S/T30-30P	7314150200924	1	34,49	161
59S/T30-3P	7314150201501	1	7,43	161
59S/T30CS	7314150444069	1	29,72	161
59S/T4	7314150198450	1	9,26	161
59S/T4-3P	7314150258857	1	5,55	161
59S/T40	7314150198610	1	12,38	161
59S/T40-30P	7314150200931	1	34,48	161
59S/T40-3P	7314150201518	1	7,43	161
59S/T40CS	7314150444076	1	29,72	161
59S/T45-3P	7314150258918	1	10,31	161
59S/T45-5P	7314150532971	1	17,17	161
59S/T5	7314150198467	1	9,26	161
59S/T5-3P	7314150258864	1	5,55	161
59S/T50	7314150198658	1	17,17	161
59S/T50-3P	7314150258925	1	10,31	161
59S/T6	7314150198474	1	11,11	161
59S/T6-3P	7314150258871	1	5,55	161
59S/T7	7314150198498	1	11,11	161
59S/T7-3P	7314150258888	1	5,55	161
59S/T8	7314150198504	1	11,11	161
59S/T8-3P	7314150258895	1	5,55	161
59S/T9	7314150198511	1	11,11	161
59S/T9-3P	7314150258901	1	5,55	161
59S/TCS11-1	7314150444083	1	18,48	165
59S/TR10	7314150198702	1	13,62	161
59S/TR10-3P	7314150201525	1	8,17	161
59S/TR15	7314150198719	1	13,62	161
59S/TR15-3P	7314150201532	1	8,17	161
59S/TR20	7314150198726	1	13,62	161
59S/TR20-3P	7314150201549	1	8,17	161
59S/TR25	7314150198740	1	13,62	161
59S/TR25-3P	7314150201556	1	8,17	161
59S/TR27	7314150198757	1	13,62	161
59S/TR27-3P	7314150201570	1	8,17	161
59S/TR30	7314150198771	1	13,62	161
59S/TR30-3P	7314150201587	1	8,17	161
59S/TR40	7314150198795	1	13,62	161
59S/TR40-3P	7314150201594	1	8,17	161
59S/TR7	7314150198672	1	13,62	161
59S/TR7-3P	7314150258932	1	8,17	161
59S/TR8	7314150198689	1	13,62	161
59S/TR8-3P	7314150258949	1	8,17	161
59S/TR9	7314150198696	1	13,62	161
59S/TR9-3P	7314150258956	1	8,17	161
59S/TS-0	7314150199389	1	36,33	162
59S/TS-1	7314150199396	1	36,33	162
59S/TS-1/4	7314150199594	1	36,33	162
59S/TS-10-5P	7314150533138	1	36,33	162
59S/TS-2	7314150199419	1	36,33	162
59S/TS-3	7314150199433	1	36,33	162
59S/TS-4-5P	7314150533152	1	36,33	162
59S/TS-5-5P	7314150533176	1	10,00	162
59S/TS-6-5P	7314150533190	1	36,33	162
59S/TS-8-5P	7314150533220	1	36,33	162
59S/TW0	7314150199617	1	33,03	162
59S/TW1	7314150199631	1	33,03	162
59S/TW2	7314150199655	1	33,03	162
59S/TW3	7314150199679	1	33,03	162
59S/TW4	7314150199693	1	33,03	162
59S/TW5	7314150199716	1	33,03	162
6	8412814220048	1	17,61	218
6-342-06-2-0	7311518021719	10	8,67	30
6-342-06-2-2	7311518244170	5	12,06	30
6-342-08-1-0	7311518021726	10	10,01	30
6-342-08-1-2	7311518028282	5	13,53	30
6-342-08-2-0	7311518021733	10	11,64	30
6-342-08-2-2	7311518005375	5	16,25	30
6-342-10-1-0	7311518021757	10	13,67	30
6-342-10-1-2	7311518005382	5	16,80	30
6-342-10-2-0	7311518021764	10	14,75	30
6-342-10-2-2	7311518005399	5	19,91	30
6-343-08-2-0	7311518021801	10	15,42	30
6-343-08-2-2	7311518001070	5	17,95	30

			€	
6-343-08-3-0	7311518021818	10	17,60	30
6-343-10-2-0	7311518021825	10	19,63	30
6-343-10-2-2	7311518001094	5	21,94	30
6-343-10-3-0	7311518021832	10	22,48	30
6-344-08-2-0	7311518021887	10	10,47	30
6-344-08-2-2	7311518005344	5	14,48	30
6-344-10-2-0	7311518021900	10	11,86	30
6-344-10-2-2	7311518005351	5	17,60	30
6-345-08-1-2	7311518028312	5	10,91	31
6-345-08-2-0	7311518021948	10	9,59	31
6-345-08-2-2	7311518005412	5	11,13	31
6-345-10-1-2	7311518005429	5	13,81	31
6-345-10-2-0	7311518021955	10	11,60	31
6-470-08-2-2	7311518242008	5	53,47	31
600-3	7314150124787	1	12,84	208
600.003.010	8412814600000	1	30,35	372
600.005.012	8412814600017	1	39,20	372
601000800	8413345202299	1	239,10	589
601001000	8413345202305	1	318,78	589
601001250	8413345202312	1	439,07	589
601001500	8413345202329	1	624,07	589
6010H0800	8413345015769	1	48,68	590
6010H1000	8413345015776	1	57,91	590
6010H1250	8413345015783	1	78,95	590
6010H1500	8413345015790	1	134,26	590
6010M0800	8413345015806	1	24,82	589
6010M1000	8413345116619	1	25,42	589
6010M1250	8413345015820	1	37,59	589
6010M1500	8413345015837	1	46,01	589
601A	7314150476282	5	193,56	654
602-4-LA	7314150224357	1	18,10	208
604-5	7314150124800	1	24,05	208
6040M0630	8413345124126	1	20,76	590
605-10-PC-AU	7314150186334	1	56,12	209
605-6	7314150153770	1	29,23	209
606-6	7314150124824	1	28,28	209
6070H1000	8413345030656	1	43,74	589
6070H1250	8413345084833	1	62,25	589
6070H1500	8413345030663	1	111,28	589
6070H1750	8413345030670	1	143,14	589
607201000	8413345030533	1	248,11	589
607201250	8413345030540	1	347,35	589
607201500	8413345030557	1	446,59	589
607201750	8413345030564	1	595,46	589
6072M1000	8413345015813	1	29,63	589
6072M1500	8413345137454	1	45,95	589
6072M1750	8413345030687	1	56,70	589
60T/17-1	7314150191529	1	28,88	158
60T/31-1	7314150191482	1	37,78	158
60T/7-1	7314150191574	1	17,59	158
60T/PH1	7314150199488	1	10,86	158
60T/PH2	7314150199495	1	10,86	158
60T/PH3	7314150199501	1	10,86	158
60T/PZ1	7314150199525	1	10,86	158
60T/PZ2	7314150199549	1	10,86	158
60T/PZ3	7314150199563	1	10,86	158
60T/T15	7314150199662	1	16,88	158
60T/T20	7314150199686	1	16,88	158
60T/T25	7314150199709	1	16,88	158
60T/T27	7314150199723	1	16,88	158
60T/T40	7314150199761	1	16,88	158
60T/T7	7314150199587	1	16,88	158
60T/T9	7314150199624	1	16,88	158
610-6	7314150124848	1	29,09	209
611-10-200	7314150124428	10	10,25	210
611-3.5-100	7314150124336	10	3,26	210
611-3.5-75	7314150124329	10	3,11	210
611-4-100	7314150124350	10	4,15	210
611-4-75	7314150124343	10	3,72	210
611-5.5-100	7314150124367	10	4,95	210
611-5.5-125	7314150124381	10	5,22	210
611-6.5-125	7314150124374	10	6,31	210
611-6.5-150	7314150124398	10	6,61	210
611-6.5-25	7314150124602	10	6,29	210
611-8-150	7314150124404	10	8,02	210
611-8-175	7314150124411	10	8,49	210
612-5	7314150124817	1	28,87	208
613-3-100	7314150124442	10	3,16	210
613-3-75	7314150124435	10	3,10	210
613-3.5-100	7314150124459	10	3,27	210
613-4-100	7314150124466	10	3,67	210
613-4-125	7314150124473	10	4,05	210
613-5.5-150	7314150124497	10	5,42	210
613-6.5-150	7314150124503	10	6,86	210
614A	7314150476305	5	167,22	654
615-0-75	7314150124558	10	3,40	210
615-1-100	7314150124565	10	4,97	210
615-2-125	7314150124572	10	6,41	210
615-2-25	7314150124596	10	6,29	210
615-3-150	7314150124589	10	9,74	210
6151	7314150539185	10	22,99	652
6152	7314150539192	10	23,90	652
6152SS	7314150539215	10	27,90	652
6159	7314150539208	10	27,90	653
616-0-75	7314150124510	10	4,42	210
616-1-100	7314150124527	10	5,35	210





616-2-125	7314150124534	10	6,88	210
616-3-150	7314150124541	10	10,32	210
618-10-75	7314150124619	10	5,15	210
618-15-100	7314150124626	10	5,42	210
618-20-100	7314150124633	10	5,42	210
618-25-125	7314150124640	10	6,29	210
618-27-125	7314150124657	10	6,29	210
618-30-150	7314150124664	10	7,74	210
618-40-150	7314150124671	10	8,79	210
61H/50PH1	7314150200382	1	14,72	159
61H/50PZ1	7314150200412	1	14,72	159
61H/50PZ2	7314150200429	1	14,72	159
61H/50PZ3	7314150200436	1	14,72	159
61H/50T10	7314150200443	1	18,68	159
61H/50T15	7314150200450	1	18,68	159
61H/50T25	7314150200474	1	18,68	159
61H/50T30	7314150200481	1	18,68	159
61H/PH1	7314150199006	1	11,58	158
61H/PH2	7314150199020	1	11,58	158
61H/PH3	7314150199044	1	5,79	159
61H/PZ3	7314150199105	1	5,79	159
61H/T10	7314150199129	1	17,83	159
61H/T15	7314150199143	1	17,83	159
61H/T20	7314150199167	1	17,83	159
61H/T25	7314150199181	1	17,83	159
61H/T40	7314150199235	1	8,93	159
620-6	7314150128594	1	49,54	497
622-3P	7314150427727	1	91,68	248
6221D	7314150421596	10	20,86	248
6221D IP	7314150440368	10	20,50	248
6222D	7314150421589	10	22,17	248
6222D IP	7314150437702	10	21,78	248
6223D	7314150421558	8	22,66	248
6223D IP	7314150421794	8	22,30	248
6224	7314150421619	4	32,19	247
6224D	7314150421565	5	20,27	248
6224D IP	7314150421800	5	19,88	248
6225D	7314150421572	10	35,79	248
6225D IP	7314150421817	5	35,38	248
623-3-100	7314150128518	10	5,90	497
623-3.5-100	7314150128525	10	6,42	497
623-4-100	7314150128532	10	6,70	497
623-5-5-125	7314150128549	10	9,30	497
623-6.5-150	7314150128556	10	11,08	497
625	7311518221614	5	30,10	548
625-0-100	7314150128563	10	4,12	497
625-1-150	7314150128570	10	7,67	497
625-2-175	7314150128587	10	10,68	497
625-DROP	7311518221638	10	13,30	548
625-PEAR	7311518221621	10	13,30	548
625-ROUND	7311518221645	10	13,30	548
6258	7314150539222	10	27,90	653
62TIN/50PH1	7314150200504	1	22,30	157
62TIN/50PH3	7314150200528	1	22,30	157
62TIN/50PZ1	7314150200535	1	22,30	157
62TIN/50PZ2	7314150200542	1	22,30	157
62TIN/50PZ3	7314150200559	1	22,30	157
62TIN/7-1	7314150203505	1	22,95	157
62TIN/PH1	7314150199259	1	20,51	157
62TIN/PZ1	7314150199327	1	20,51	157
62TIN/PZ2	7314150199334	1	20,51	157
62TIN/PZ3	7314150199358	1	20,51	157
62TIN/T15	7314150199402	1	25,32	157
62TIN/T20	7314150199426	1	25,32	157
62TIN/T25	7314150199440	1	25,32	157
62TIN/T30	7314150199464	1	25,32	157
63D/50PZ1	7314150200320	1	26,53	157
63D/50PZ2	7314150200337	1	26,53	157
63D/50PZ3	7314150200344	1	26,53	157
63D/7-1	7314150191604	1	28,85	157
63D/PH2G	7314150198979	1	19,90	156
63D/PH3	7314150198948	1	16,88	156
63D/PZ1	7314150198856	1	16,88	156
63D/PZ2	7314150198870	1	16,88	156
63D/T10	7314150198665	1	19,30	156
63D/T15	7314150198733	1	19,30	156
63D/T40	7314150198832	1	19,30	156
64A/PH1	7314150198481	1	14,95	157
64A/PH3	7314150198573	1	14,95	157
64A/PZ1	7314150198603	1	14,95	158
64A/PZ3	7314150198634	1	14,95	158
650	7311518221591	5	29,42	548
65I/7-1	7314150204113	1	26,36	529
65I/PH1	7314150199785	1	28,05	529
65I/PH1-2P	7314150207985	1	6,62	529
65I/PH2	7314150199884	1	28,05	529
65I/PH2-2P	7314150201259	1	6,62	529
65I/PH3	7314150199907	1	28,05	529
65I/PH3-2P	7314150201266	1	6,62	529
65I/PZ1	7314150199921	1	28,05	529
65I/PZ1-2P	7314150201273	1	6,62	529
65I/PZ2	7314150199945	1	28,05	529
65I/PZ2-2P	7314150201280	1	6,62	529
65I/PZ3	7314150199969	1	28,05	529
65I/PZ3-2P	7314150201297	1	6,62	529
65I/T15	7314150199990	1	16,04	529



65I/T25	7314150200030	1	15,27	529
65I/T30	7314150200054	1	15,27	529
65I/T40	7314150200078	1	16,04	529
65I/T40-2P	7314150201358	1	7,29	529
665	7311518221607	5	42,59	548
66M/10C-1	7314150450732	1	22,11	160
66M/11C-1	7314150450718	1	17,68	160
66M/50PH1-2P	7314150446056	1	3,88	159
66M/50PH2-2P	7314150446063	1	3,88	159
66M/50PH3-2P	7314150446087	1	3,88	159
66M/50PZ1-2P	7314150446094	1	3,88	160
66M/50PZ2-2P	7314150446100	1	3,88	160
66M/50PZ3-2P	7314150446117	1	3,88	160
66M/50T10C-2P	7314150446131	1	3,93	160
66M/50T15C-2P	7314150446148	1	3,93	160
66M/50T20C-2P	7314150446155	1	3,93	160
66M/50T25C-2P	7314150446162	1	3,93	160
66M/50T27C-2P	7314150446179	1	3,93	160
66M/50T30C-2P	7314150446186	1	3,93	160
66M/50T40C-2P	7314150446193	1	3,93	160
66M/PH1-2P	7314150445929	1	3,05	159
66M/PH2-2P	7314150445936	1	3,05	159
66M/PH3-2P	7314150445943	1	3,05	159
66M/PZ1-2P	7314150445950	1	3,05	159
66M/PZ2-2P	7314150445967	1	3,05	159
66M/PZ3-2P	7314150445974	1	3,05	159
66M/T10C-2P	7314150445981	1	3,14	159
66M/T15C-2P	7314150445998	1	3,14	159
66M/T20C-2P	7314150446001	1	3,14	159
66M/T25C-2P	7314150446018	1	3,14	159
66M/T27C-2P	7314150446025	1	3,14	159
66M/T30C-2P	7314150446032	1	3,14	159
66M/T40C-2P	7314150446049	1	3,14	159
6700SM-10	7314151088026	5	5,13	78
6700SM-11	7314151088033	5	5,13	78
6700SM-12	7314151088040	5	5,13	78
6700SM-13	7314151088057	5	5,13	78
6700SM-14	7314151088064	5	5,13	78
6700SM-4	7314151087944	5	5,13	78
6700SM-4.5	7314151087951	5	5,13	78
6700SM-5	7314151087968	5	5,13	78
6700SM-5.5	7314151087975	5	5,13	78
6700SM-6	7314151087982	5	5,13	78
6700SM-7	7314151087999	5	5,13	78
6700SM-8	7314151088002	5	5,13	78
6700SM-9	7314151088019	5	5,13	78
6700SZ-1/2	7314151088194	5	5,21	78
6700SZ-1/4	7314151088132	5	5,21	78
6700SZ-1/8	7314150346349	5	5,21	78
6700SZ-11/32	7314151088163	5	5,21	78
6700SZ-3/16	7314151088118	5	5,21	78
6700SZ-3/8	7314151088170	5	5,21	78
6700SZ-5/16	7314151088156	5	5,21	78
6700SZ-5/32	7314151808556	5	5,21	78
6700SZ-7/16	7314151088187	5	5,21	78
6700SZ-7/32	7314151088125	5	5,21	78
6700SZ-9/16	7314151088200	5	5,21	78
6700SZ-9/32	7314151088149	5	5,21	78
6700TORX-E10	7314153011725	5	6,87	78
6700TORX-E4	7314153011671	5	6,87	78
6700TORX-E5	7314153011688	5	6,87	78
6700TORX-E6	7314153011695	5	6,87	78
6700TORX-E7	7314153011701	5	6,87	78
6700TORX-E8	7314153011718	5	6,87	78
6706TE	7314150220199	1	47,00	69
6708DMB	7314150220205	1	94,59	69
6709-IP10	7314150354498	1	8,77	83
6709-IP15	7314150354504	1	8,77	83
6709-IP20	7314150354511	1	8,77	83
6709-IP25	7314150354528	1	9,10	83
6709-IP27	7314150354535	1	8,77	83
6709-IP30	7314150354542	1	8,39	83
6709-IP40	7314150354559	1	10,46	83
6709-IP45	7314150354566	1	10,46	83
6709-IP6	7314150460373	1	8,39	83
6709-IP7	7314150460366	1	8,39	83
6709-IP8	7314150460359	1	8,71	83
6709-IP9	7314150460342	1	8,71	83
6709F-4.5	7314151830762	5	6,81	82
6709F-5.5	7314151830779	5	6,81	82
6709F-6.5	7314150220397	5	6,81	82
6709F-8	7314151830786	5	6,81	82
6709HL	7314150128457	1	9,70	81
6709M-10	7314150430833	5	6,73	83
6709M-3	7314151830656	5	6,74	83
6709M-4	7314151830663	5	6,74	83
6709M-5	7314151830670	5	6,74	83
6709M-6	7314151830687	5	6,74	83
6709M-8	7314151830694	5	6,74	83
6709PH-1	7314151830700	5	7,45	82
6709PH-2	7314151830717	5	7,45	82
6709PH-3	7314151830724	5	7,45	82
6709PZ-1	7314151830731	5	7,91	82
6709PZ-2	7314151830748	5	7,91	82
6709PZ-3	7314151830755	5	7,91	82
6709TORX-R-T10	7314153002471	1	8,79	83



6709TORX-R-T15	7314153002488	1	8,79	83
6709TORX-R-T20	7314153002495	1	8,79	83
6709TORX-R-T25	7314153002501	1	9,11	83
6709TORX-R-T8	7314153002464	1	8,79	83
6709TORX-T10	7314151811679	5	8,39	83
6709TORX-T15	7314151811686	5	8,39	83
6709TORX-T20	7314151811693	5	8,39	83
6709TORX-T25	7314151811709	5	8,67	83
6709TORX-T27	7314151811716	5	8,67	83
6709TORX-T30	7314151811723	5	8,67	83
6709TORX-T40	7314153002457	5	8,67	83
6709TORX-T6	7314150460540	5	8,09	83
6709TORX-T7	7314150460557	5	8,09	83
6709TORX-T8	7314153002440	5	8,39	83
6709TORX-T9	7314151811662	5	8,39	83
671002600	8413345128971	50	148,67	553
671002850	8413345128988	1	113,57	553
6711MB	7314150220298	1	59,75	69
6712R	7314151838225	1	125,40	65
6712RN	7314151838232	1	120,37	65
6713MH	7314150220212	1	68,64	68
6715GE	7314151831370	1	223,49	67
6715GJ	7314151831363	1	256,16	67
6715MG	7314151831349	1	205,49	66
6715MGS	7314151831332	1	166,88	65
6715MZ	7314153003218	1	206,86	68
6715PZ	7314151837525	1	255,22	67
6717MBP	7314150218806	1	173,99	66
6719MHR	7314150218783	1	179,64	65
6719SM	7314151820817	1	170,20	66
6720NM	7314151088262	1	311,37	67
6721NM	7314151088309	1	278,06	66
6722M	7314151594411	1	226,83	67
6729MHP	7314150218752	1	193,09	66
6729MHR	7314150218769	1	189,76	65
6729SM	7314153003225	1	79,67	68
6729SZ	7314153003232	1	53,26	68
6730MBP	7314150218776	1	197,59	66
677-10	7314150362486	1	32,63	51
677-13	7314150362493	1	32,63	51
677-3/8	7314150362509	1	32,28	51
677-7	7314150362455	1	32,63	51
677-8	7314150362462	1	32,63	51
677-9	7314150362479	1	32,63	51
679-1/2	7314150363384	1	42,86	54
679-10	7314150357345	1	50,06	54
679-11	7314150357352	1	45,02	54
679-12	7314150357369	1	50,47	54
679-13	7314150357376	1	50,71	54
679-14	7314150357383	1	54,60	54
679-3/8	7314150363360	1	42,86	54
679-7	7314150357536	1	45,02	54
679-7/16	7314150363377	1	42,86	54
679-8	7314150357079	1	45,02	54
679-9	7314150357338	1	45,97	54
679-9/16	7314150363391	1	42,86	54
6821NZ	7314151089269	1	269,96	68
6852-5	7314150125463	1	271,19	111
6852-5/S17	7314150135875	1	297,67	112
6852P-5	7314150416585	1	305,38	112
6876N	7314151845575	1	273,57	112
6878N	7314151845582	1	280,40	112
6880N	7314151845599	1	310,60	112
690000160	8413345008068	1	60,64	610
690000200	8413345008082	1	76,02	610
690000220	8413345008099	1	76,02	610
690000250	8413345008105	1	86,33	610
690000300	8413345008129	1	93,45	610
690000320	8413345087476	1	93,45	610
690000350	8413345008136	1	119,67	610
690000400	8413345008143	1	128,29	610
690000500	8413345008167	1	157,43	610
690000630	8413345111065	1	364,89	610
69079019P	8413345111089	1	986,68	610
690900080	8413345016209	4	12,66	610
690900100	8413345016216	4	18,69	610
690900120	8413345016223	2	18,69	610
690900140	8413345016230	2	27,88	610
690900200	8413345016247	1	55,09	610
6950	7314151089641	1	40,82	84
6950-SPARE	7314150187867	1	18,13	85
6950RN	7314151831189	1	36,99	84
6950RN-SPARE	7314150209149	1	17,41	85
6950SL	7314150197668	1	41,21	84
6950SL-SPARE	7314150210251	1	17,63	85
6951	7314151089764	1	80,43	84
6954	7314151089795	1	11,63	80
6956	7314151089825	10	12,02	80
6958-6	7314150476329	1	21,58	80
6960	7314151089856	1	8,98	81
6960-3	7314150489381	10	9,27	81
6960F-6	7314150489206	20	9,86	81
6960W-2	7314150470860	10	11,02	81
6960W-4	7314150470877	1	12,86	81
6960W-6	7314150470884	10	14,70	81
6961	7314151089870	1	10,43	81



6962	7314151089894	1	12,46	81
6962L	7314151089917	1	29,85	81
6966	7314151089986	10	23,63	81
6968	7314150128426	1	30,09	81
6969	7314150489268	1	1,34	82
696EX-01	7314150386192	1	7,71	81
696EX-06	7314150386239	1	9,30	81
696EX-08	7314150386246	1	12,82	81
696EX-11	7314150386208	1	14,14	81
6972H	7314151215934	5	22,59	81
6973A	7314150339495	10	7,29	82
6973M	7314150339501	1	6,69	81
6973N	7314151845605	1	297,00	111
6976N	7314151845612	1	303,90	111
6978N	7314151845629	1	310,61	111
6M-10-11	7314151832094	10	5,96	48
6M-10-13	7314151832117	10	7,32	48
6M-12-13	7314151832131	10	7,25	48
6M-12-14	7314151832148	10	7,76	48
6M-13-14	7314151832155	10	7,69	48
6M-13-15	7314151832162	10	8,53	48
6M-13-16	7314151832179	10	9,24	48
6M-13-17	7314151832186	10	9,07	48
6M-14-15	7314151832193	10	7,69	48
6M-14-17	7314151832209	10	8,92	48
6M-16-17	7314151832216	10	8,92	48
6M-16-18	7314151832223	10	9,76	48
6M-17-19	7314151832230	10	10,05	48
6M-18-19	7314151832247	10	10,05	48
6M-19-22	7314151832261	10	12,16	48
6M-19-24	7314151832278	10	12,90	48
6M-20-22	7314151832285	10	11,91	48
6M-21-23	7314151832292	10	12,98	48
6M-21-24	7314151838072	10	14,33	48
6M-22-24	7314151832308	10	12,96	48
6M-24-26	7314151832315	10	15,08	48
6M-24-27	7314151832322	10	15,37	48
6M-24-30	7314151832339	5	17,79	48
6M-25-28	7314151832353	5	17,52	48
6M-27-29	7314150189861	5	20,86	48
6M-27-30	7314151832360	5	21,77	48
6M-27-32	7314151832377	5	23,82	48
6M-30-32	7314151832384	5	23,52	48
6M-30-36	7314151832407	5	39,16	48
6M-32-36	7314151832414	5	41,17	48
6M-34-36	7314151832421	1	43,22	48
6M-36-41	7314151832438	1	46,93	48
6M-38-42	7314151832445	1	55,80	48
6M-4-5	7314151832018	10	5,44	48
6M-4-5-5-5	7314151832025	10	6,97	48
6M-41-46	7314151832452	1	66,05	48
6M-46-50	7314151832469	1	86,11	48
6M-5-5-5	7314151832032	10	7,04	48
6M-5-5-7	7314151832049	10	5,45	48
6M-6-7	7314151832056	10	5,45	48
6M-7-8	7314151832063	10	5,78	48
6M-8-10	7314151832087	10	5,89	48
6M-8-9	7314151832070	10	5,48	48
6M/10C	7314150212934	1	93,07	50
6M/12C	7314150212941	1	135,38	50
6M/6C	7314150212910	1	41,81	50
6M/8C	7314150212927	1	64,30	50
6M/S8	7314151832483	1	63,08	49
6M/SH12	7314153013439	1	144,95	49
6M/SH8	7314150201365	1	78,45	49
6MV-10	7314150120871	5	23,48	501
6MV-11	7314150120888	5	23,63	501
6MV-12	7314150120895	5	24,81	501
6MV-13	7314150120901	5	26,07	501
6MV-14	7314150120918	5	26,07	501
6MV-15	7314150120925	5	25,96	501
6MV-16	7314150120932	5	27,35	501
6MV-17	7314150120949	3	27,86	501
6MV-18	7314150120956	3	28,50	501
6MV-19	7314150120963	3	29,57	501
6MV-20	7314150120970	3	31,01	501
6MV-21	7314150120987	3	33,43	501
6MV-22	7314150120994	3	34,88	501
6MV-23	7314150121007	3	38,87	501
6MV-24	7314150121014	3	40,35	501
6MV-27	7314150121021	2	46,52	501
6MV-30	7314150121038	2	51,87	501
6MV-32	7314150121052	2	53,14	501
6MV-6	7314150120833	5	24,09	501
6MV-7	7314150120840	5	24,41	501
6MV-8	7314150120857	5	22,18	501
6MV-9	7314150120864	5	23,21	501
6MV/10T	7314150213023	1	282,64	504
6MV/8T	7314150122141	1	210,84	504
6Z-1-1-1/8	7314151832674	1	17,99	49
6Z-1.1/16-1.1/4	7314151832681	1	23,83	49
6Z-1.1/4-1.3/8	7314151832698	1	41,36	49
6Z-1/2-9/16	7314151832568	5	7,91	49
6Z-1/4-5/16	7314151832520	5	5,59	49
6Z-11/16-3/4	7314151832612	5	10,30	49
6Z-13/16-7/8	7314151832643	5	12,28	49





6Z-15/16-1	7314151832667	5	15,53	49
6Z-19/32-11/16	7314151832582	5	9,92	49
6Z-25/32-13/16	7314151832636	5	14,18	49
6Z-3/4-7/8	7314151832629	5	12,28	49
6Z-3/8-7/16	7314151832544	5	6,25	49
6Z-5/16-11/32	7314151832537	5	5,59	49
6Z-5/8-3/4	7314151832605	5	10,30	49
6Z-7/16-1/2	7314151832551	5	7,47	49
6Z-7/8-15/16	7314151832650	5	15,88	49
6Z-9/16-5/8	7314151832575	5	7,91	49
6Z/8C	7314150212958	1	74,83	50
700-1-50	7314153017673	5	7,67	213
700-1.2-50	7314153017680	5	7,67	213
700-1.5-50	7314153017697	5	7,67	213
700-1.8-50	7314153017703	5	7,67	213
700-2-50	7314153017710	5	6,71	213
700-2.5-50	7314153017741	5	6,71	213
700-3-100	7314153017772	5	6,42	213
700-3-200	7314153017789	5	7,38	213
700-3-50	7314153017765	5	6,42	213
700-3.5-75	7314153017796	5	6,71	213
700-4-250	7314153017819	5	8,66	213
700-4-75	7314153017802	5	6,95	213
701-0-200	7314153017857	5	8,44	214
701-0-50	7314153017840	5	6,71	214
701-00-50	7314153017833	5	7,96	214
701-1-250	7314153017871	5	7,97	214
701-1-75	7314153017864	5	7,51	214
702-0-50	7314153017888	5	7,56	214
702-1-75	7314153017895	5	8,04	214
703-10-50	7314153017963	5	7,35	214
703-15-75	7314153017970	5	7,35	214
703-20-75	7314153017987	5	7,35	214
703-4-50	7314153017901	5	9,18	214
703-5-50	7314153017918	5	9,18	214
703-6-50	7314153017925	5	7,35	214
703-7-50	7314153017932	5	7,35	214
703-8-50	7314153017949	5	7,35	214
703-9-50	7314153017956	5	7,35	214
704-1.5-50	7314153017994	5	8,44	214
704-2-50	7314153018007	5	8,44	214
704-2.5-50	7314153018014	5	8,44	214
704-3-75	7314153018021	5	8,44	214
704Z-3/32	7314150137428	5	8,43	214
706-1	7314153018045	1	45,66	212
706-2	7314153018052	1	47,60	212
706-3	7314153018069	1	47,60	213
706-4	7314153018076	1	53,63	213
706-5	7314153018083	1	181,59	213
70S/1.2-8.0-2P	7314150262823	1	8,38	168
70S/1.6-10.0	7314150218394	1	29,75	168
70S/1.6-10.0-2P	7314150261017	1	11,90	168
70S/1.6-9.0	7314150218400	1	20,95	168
70S/1.6-9.0-2P	7314150261024	1	8,38	168
70S/2.0-12.0	7314150218417	1	32,51	169
70S/2.0-12.0-2P	7314150261086	1	13,00	169
70S/2.5-14.0	7314150218424	1	36,68	169
70S/2.5-14.0-2P	7314150261147	1	14,68	169
70S/H10	7314150218486	1	22,26	169
70S/H10-2P	7314150261451	1	8,90	169
70S/H12	7314150218493	1	23,71	169
70S/H12-2P	7314150261468	1	9,47	169
70S/H14	7314150218509	1	23,71	169
70S/H14-2P	7314150261475	1	9,47	169
70S/H4	7314150218431	1	18,41	169
70S/H4-2P	7314150261352	1	7,37	169
70S/H5	7314150218448	1	18,41	169
70S/H5-2P	7314150261406	1	7,37	169
70S/H6	7314150218455	1	18,41	169
70S/H6-2P	7314150261437	1	7,37	169
70S/H7	7314150218462	1	18,41	169
70S/H7-2P	7314150261444	1	7,37	169
70S/H8-5P	7314150538782	1	8,72	169
70S/H8-2P	7314150262847	1	7,37	169
70S/PH1	7314150217557	1	18,41	169
70S/PH1-2P	7314150260621	1	7,37	169
70S/PH2	7314150217564	1	18,41	169
70S/PH2-2P	7314150260638	1	7,37	169
70S/PH3	7314150217571	1	18,41	169
70S/PH3-2P	7314150260645	1	7,37	169
70S/PH4	7314150217588	1	18,41	169
70S/PH4-2P	7314150260652	1	7,37	169
70S/PZ1	7314150217595	1	18,41	169
70S/PZ1-2P	7314150260683	1	7,37	169
70S/PZ2	7314150217601	1	18,41	169
70S/PZ2-2P	7314150260706	1	7,37	169
70S/PZ3	7314150217724	1	18,41	169
70S/PZ3-2P	7314150260720	1	7,37	169
70S/PZ4	7314150217731	1	18,41	169
70S/PZ4-2P	7314150260737	1	7,37	169
70S/T20	7314150217748	1	23,08	169
70S/T20-2P	7314150260744	1	9,23	169
70S/T25-2P	7314150260812	1	9,23	169
70S/T25-5P	7314150538508	1	23,08	169
70S/T27-5P	7314150538522	1	10,75	169
70S/T27-2P	7314150260867	1	9,23	169



70S/T30	7314150217779	1	23,08	169
70S/T30-2P	7314150260881	1	9,23	169
70S/T40-2P	7314150260898	1	9,23	169
70S/T45	7314150217793	1	23,08	169
70S/T45-2P	7314150260904	1	9,23	169
70S/T50	7314150217809	1	23,08	169
70S/T50-2P	7314150260911	1	9,23	169
70S/T55	7314150217816	1	31,94	169
70S/T55-2P	7314150260928	1	12,76	169
70S/TS1/4	7314150218349	1	38,46	169
70S/TS1/4-2P	7314150260935	1	15,38	169
70S/TS10	7314150218356	1	43,13	169
70S/TS10-2P	7314150260942	1	17,25	169
70S/TS5/16	7314150218363	1	43,13	169
70S/TS5/16-2P	7314150260959	1	17,25	169
70S/TS8	7314150218370	1	43,13	169
70S/TS8-2P	7314150260966	1	17,25	169
7106J	7314150339518	1	8,53	88
7154TC	7314150475148	10	226,53	649
7190	7314150052479	10	61,47	644
7190 CO	7314150052790	10	67,82	644
7191	7314150052509	10	59,47	644
7191 CO	7314150052806	10	72,90	644
7223	7314150237722	4	33,32	247
7223D	7314150421527	8	32,19	247
7223D IP	7314150440306	8	31,00	247
7223IP	7314150421855	8	31,59	247
7224	7311518274733	4	34,43	247
7224-622XD-3P	7314150426973	1	88,03	249
7224IP	7314150421831	4	32,79	247
7224S	7314150421657	4	39,34	501
7225	7314150237739	8	43,35	247
7225D	7314150421541	4	42,33	247
7225D IP	7314150440320	4	41,37	247
7225IP	7314150421848	4	41,72	247
7280	7314150052523	10	74,93	647
7285	7314150052530	10	82,28	647
7290	7314150052547	10	68,21	645
7291	7314150052554	10	71,83	645
7292	7314150052578	10	45,06	646
7292G	7314150434701	10	125,54	648
7293	7314150052592	10	81,83	646
7372I-2-63	7314151398668	10	13,17	218
7372I-2.5-75	7314151399047	10	13,17	218
7372I-3-80	7314151341602	10	13,17	218
7400SM-10	7314151092955	5	6,12	85
7400SM-11	7314151092962	5	6,20	85
7400SM-12	7314151092979	5	6,29	85
7400SM-13	7314151092986	5	6,45	85
7400SM-14	7314151092993	5	6,89	85
7400SM-15	7314151093006	5	7,16	85
7400SM-16	7314151831127	5	7,56	85
7400SM-17	7314151093020	5	7,74	85
7400SM-18	7314151831134	5	7,92	85
7400SM-19	7314151093044	5	8,24	85
7400SM-20	7314153002570	5	8,46	85
7400SM-21	7314153002587	5	8,71	85
7400SM-22	7314153002594	5	8,85	85
7400SM-6	7314151092917	5	5,58	85
7400SM-7	7314151092924	5	5,58	85
7400SM-8	7314151092931	5	5,68	85
7400SM-9	7314151092948	5	5,90	85
7400SR/S12	7314153003294	1	82,22	71
7400SZ-1/2	7314150385942	1	7,34	85
7400SZ-1/4	7314150385959	1	7,22	85
7400SZ-11/16	7314150385966	1	7,45	85
7400SZ-11/32	7314150385973	1	7,45	85
7400SZ-13/16	7314150385980	1	7,45	85
7400SZ-3/4	7314150385997	1	7,45	85
7400SZ-3/8	7314150386000	1	7,22	85
7400SZ-5/16	7314150386017	1	7,22	85
7400SZ-5/8	7314150386024	1	7,45	85
7400SZ-7/16	7314150386031	1	7,34	85
7400SZ-7/8	7314150386048	1	7,45	85
7400SZ-9/16	7314150386055	1	7,34	85
7400TORX-E10	7314153003058	5	10,88	86
7400TORX-E11	7314153003065	5	10,88	86
7400TORX-E12	7314153003072	5	10,88	86
7400TORX-E14	7314153003089	5	11,89	86
7400TORX-E16	7314153003096	5	11,89	86
7400TORX-E18	7314153003102	5	12,48	86
7400TORX-E8	7314150118243	5	10,88	86
7400TORX-ER/S7	7314153003300	1	80,21	71
7402GPR-16	7314150503087	120	2,94	307
7402GPR-18	7314150503094	120	5,05	307
7402GPR-21	7314150503100	100	3,46	307
7406ZZ-16	7314153011992	1	31,97	307
7406ZZ-21	7314153012005	1	31,97	307
7407H	7314151218249	1	25,23	173
7408H	7314151218300	1	25,23	173
7408MD	7314150220328	1	118,13	71
7409BH-10	7314153002112	5	14,01	90
7409BH-4	7314153002075	5	11,40	90
7409BH-5	7314153002082	1	11,40	90
7409BH-6	7314153002099	5	11,40	90
7409BH-8	7314153002105	5	12,36	90

			€	
7409F-10	7314153002143	5	6,54	89
7409F-6.5	7314153002129	5	6,54	89
7409F-8	7314153002136	5	6,54	89
7409H	7314151218355	1	29,24	173
7409M-10	7314153001962	5	11,63	90
7409M-3	7314153002235	5	10,62	90
7409M-4	7314153001900	5	10,62	90
7409M-5	7314153001917	5	10,62	90
7409M-6	7314153001924	5	10,62	90
7409M-7	7314153001931	5	10,62	90
7409M-8	7314153001948	5	11,63	90
7409MB	7314150220236	1	69,49	71
7409MR/S7	7314153003256	1	77,17	90
7409PH-1	7314153002150	5	6,89	89
7409PH-2	7314153002167	5	6,89	89
7409PH-3	7314153002174	5	6,89	89
7409TORX-R-T27	7314153001856	5	13,00	89
7409TORX-R-T30	7314153001863	5	13,00	89
7409TORX-R-T40	7314153001870	5	15,29	89
7409TORX-R-T45	7314153001887	5	15,60	89
7409TORX-R-T50	7314153001894	5	16,23	89
7409TORX-T20	7314150220403	5	11,72	89
7409TORX-T25	7314153001771	5	11,72	89
7409TORX-T25-L	7314153011237	5	19,05	90
7409TORX-T27	7314153001788	5	11,72	89
7409TORX-T30	7314153001795	5	11,72	89
7409TORX-T30-L	7314153011244	5	19,05	90
7409TORX-T40	7314153001801	5	14,21	89
7409TORX-T40-L	7314153011251	5	22,28	90
7409TORX-T45	7314153001818	5	14,21	89
7409TORX-T45-L	7314153011268	5	22,28	90
7409TORX-T50	7314153001825	5	14,21	89
7409TORX-T50-L	7314153011275	5	22,28	90
7409TORX-TRR/S5	7314153003263	1	70,25	89
7409Z-1/4	7314150386062	1	9,57	90
7409Z-1/8	7314150386079	1	9,57	90
7409Z-3/16	7314150386086	1	9,57	90
7409Z-3/8	7314150386093	1	10,48	90
7409Z-5/32	7314150386109	1	9,57	90
7409Z-7/32	7314150386116	1	9,57	90
7422MBR	7314150218844	1	248,73	71
7422MHR	7314150218868	1	241,85	71
7444SG-M-100	7314151830014	1	474,87	55
7444SG-M-105	7314151830021	1	535,71	55
7444SG-M-110	7314151830038	1	590,67	55
7444SG-M-115	7314151830045	1	679,84	55
7444SG-M-120	7314151830052	1	989,69	55
7444SG-M-125	7314151830069	1	1.280,31	55
7444SG-M-130	7314151830076	1	1.392,43	55
7444SG-M-135	7314151830083	1	1.436,30	55
7444SG-M-140	7314151830090	1	1.628,91	55
7444SG-M-145	7314151830106	1	2.261,60	55
7444SG-M-150	7314151830113	1	2.380,87	55
7444SG-M-155	7314151830120	1	2.585,00	55
7444SG-M-160	7314150132508	1	2.739,29	55
7444SG-M-165	7314150132515	1	2.909,95	55
7444SG-M-170	7314150132522	1	3.198,45	55
7444SG-M-175	7314150132539	1	3.431,08	55
7444SG-M-24	7314150205400	1	36,28	55
7444SG-M-27	7314151829834	1	39,46	55
7444SG-M-30	7314151829841	1	40,66	55
7444SG-M-32	7314151829858	1	40,66	55
7444SG-M-34	7314151838560	1	59,56	55
7444SG-M-36	7314151829865	1	51,91	55
7444SG-M-38	7314150180936	1	61,09	55
7444SG-M-41	7314151829872	1	66,28	55
7444SG-M-42	7314151829889	1	66,28	55
7444SG-M-46	7314151829896	1	72,64	55
7444SG-M-50	7314151829919	1	81,67	55
7444SG-M-55	7314151829926	1	93,40	55
7444SG-M-60	7314151829933	1	98,45	55
7444SG-M-65	7314151829940	1	131,94	55
7444SG-M-70	7314151829957	1	152,58	55
7444SG-M-75	7314151829964	1	163,84	55
7444SG-M-80	7314151829971	1	217,98	55
7444SG-M-85	7314151829988	1	291,91	55
7444SG-M-90	7314151829995	1	381,65	55
7444SG-M-95	7314151830007	1	421,68	55
7444SG-Z-1.1/16	7314150132546	1	43,41	55
7444SG-Z-1.1/2	7314150132614	1	67,19	55
7444SG-Z-1.1/4	7314150132577	1	44,73	55
7444SG-Z-1.1/8	7314150132553	1	44,73	55
7444SG-Z-1.11/16	7314150132638	1	72,90	55
7444SG-Z-1.13/16	7314150132652	1	79,91	55
7444SG-Z-1.3/16	7314150132560	1	44,73	55
7444SG-Z-1.3/4	7314150132645	1	79,91	55
7444SG-Z-1.3/8	7314150132591	1	65,54	55
7444SG-Z-1.5/16	7314150132584	1	65,54	55
7444SG-Z-1.5/8	7314150132621	1	72,90	55
7444SG-Z-1.7/16	7314150132607	1	65,54	55
7444SG-Z-1.7/8	7314150132669	1	89,83	55
7444SG-Z-2	7314150132676	1	89,83	55
7444SG-Z-2.1/16	7314150132683	1	102,75	55
7444SG-Z-2.1/4	7314150132713	1	108,32	55
7444SG-Z-2.1/8	7314150132690	1	108,32	55
7444SG-Z-2.3/16	7314150132706	1	108,32	55

			€	
7444SG-Z-2.3/4	7314150132768	1	167,85	55
7444SG-Z-2.3/8	7314150132720	1	133,79	55
7444SG-Z-2.5/8	7314150132751	1	167,85	55
7444SG-Z-2.9/16	7314150132744	1	167,85	55
7444SG-Z-3	7314150132775	1	180,23	55
7444SG-Z-3.1/2	7314150132805	1	419,82	55
7444SG-Z-3.1/8	7314150132782	1	285,36	55
7444SG-Z-3.3/4	7314150132812	1	463,86	55
7444SG-Z-3.3/8	7314150132799	1	321,10	55
7444SG-Z-3.7/8	7314150132829	1	522,38	55
7444SG-Z-4	7314150132836	1	589,27	55
7444SG-Z-4.1/2	7314150132850	1	747,83	55
7444SG-Z-4.1/8	7314150132843	1	589,27	55
7454-1400	7314150119592	1	2.340,84	109
7454-1400E	7314150119615	1	3.814,89	109
7454-140A	7314150509515	1	465,56	108
7454-17	7314150509492	1	326,51	108
7454-230	7314150509522	1	473,80	108
7454-3.5	7314150509478	1	326,51	108
7454-32	7314150509508	1	244,30	108
7454-480	7314150119578	1	1.027,67	109
7454-70A	7314150509577	1	347,11	108
7454-8.4	7314150509485	1	326,51	108
7454-800A	7314150509584	1	834,30	108
7454-800E	7314150119608	1	1.712,80	109
7455-100	7314150125111	1	251,89	106
7455-1000	7314150368303	1	1.090,07	106
7455-100A	73141501340156	1	238,05	106
7455-15	7314150119646	1	251,88	106
7455-1500	7314150125166	1	1.390,00	107
7455-20	7314150125074	1	251,88	106
7455-200	7314150125128	1	277,07	106
7455-25	7314150125081	1	251,88	106
7455-2500	7314150125173	1	5.642,17	107
7455-300	7314150125104	1	311,00	106
7455-340	7314150125135	1	311,00	106
7455-5	7314150119639	1	251,88	106
7455-500	7314150125142	1	629,71	106
7455-60	7314150125098	1	251,89	106
7455-800	7314150125159	1	818,64	106
7456-80LB	7314150119783	1	314,87	107
7465-100	7314150340200	1	238,05	107
7465-15	7314150340170	1	225,53	107
7465-1500	7314150340248	1	1.741,58	107
7465-200	7314150340217	1	269,38	107
7465-30	7314150340187	1	231,80	107
7465-340	7314150340224	1	294,44	107
7465-5	7314150340163	1	220,51	107
7465-60	7314150340194	1	238,05	107
7465-800	7314150340231	1	751,76	107
747-1	7314150362899	1	48,70	51
747-1.1/16	7314150362905	1	48,70	51
747-1.1/2	7314150362974	1	60,14	51
747-1.1/4	7314150362936	1	48,70	51
747-1.1/8	7314150362912	1	46,92	51
747-1.11/16	7314150363001	1	85,15	51
747-1.13/16	7314150363025	1	97,64	51
747-1.15/16	7314150363049	1	97,13	51
747-1.3/16	7314150362929	1	48,70	51
747-1.3/4	7314150363018	1	89,91	51
747-1.3/8	7314150362950	1	48,70	51
747-1.5/16	7314150362943	1	49,90	51
747-1.5/8	7314150362998	1	80,97	51
747-1.7/16	7314150362967	1	60,14	51
747-1.7/8	7314150363032	1	97,64	51
747-1.9/16	7314150362981	1	61,94	51
747-1/2	7314150362813	1	32,28	51
747-10	7314150362516	1	32,81	51
747-11	7314150362523	1	34,30	51
747-11/16	7314150362844	1	38,47	51
747-12	7314150362530	1	31,79	51
747-13	7314150362547	1	31,79	51
747-13/16	7314150362868	1	41,91	51
747-14	7314150362554	1	29,53	51
747-15	7314150362561	1	37,87	51
747-15/16	7314150362882	1	48,70	51
747-16	7314150362578	1	38,57	51
747-17	7314150362585	1	35,61	51
747-18	7314150362592	1	41,91	51
747-19	7314150362608	1	35,61	51
747-2	7314150363056	1	100,62	51
747-2.1/16	7314150363063	1	102,18	51
747-2.1/2	7314150363131	1	149,81	51
747-2.1/4	7314150363094	1	133,36	51
747-2.1/8	7314150363070	1	129,79	51
747-2.3/16	7314150364893	1	133,36	51
747-2.3/4	7314150363162	1	156,11	51
747-2.3/8	7314150363117	1	140,17	51
747-2.5/16	7314150363100	1	133,36	51
747-2.5/8	7314150363155	1	156,11	51
747-2.7/8	7314150363124	1	149,81	51
747-2.7/16	7314150363179	1	195,77	51
747-2.9/16	7314150363148	1	149,81	51
747-20	7314150362615	1	48,12	51
747-21	7314150362622	1	48,12	51
747-22	7314150362639	1	48,12	51





747-23	7314150362646	1	48,70	51
747-24	7314150362653	1	49,18	51
747-25	7314150362660	1	49,48	51
747-26	7314150362677	1	49,90	51
747-27	7314150362684	1	48,70	51
747-28	7314150362691	1	52,75	51
747-3/4	7314150362851	1	38,47	51
747-3/8	7314150362790	1	31,57	51
747-30	7314150362707	1	48,70	51
747-32	7314150362714	1	48,70	51
747-34	7314150362721	1	53,12	51
747-36	7314150362738	1	60,14	51
747-40	7314150362745	1	74,43	51
747-41	7314150362752	1	86,93	51
747-42	7314150362769	1	86,93	51
747-46	7314150362776	1	103,00	51
747-5/8	7314150362837	1	38,47	51
747-50	7314150362783	1	103,00	51
747-7/16	7314150362806	1	32,97	51
747-7/8	7314150362875	1	48,70	51
747-9/16	7314150362820	1	32,29	51
749-1	7314150363506	1	54,78	54
749-1.1/16	7314150363513	1	54,78	54
749-1.1/2	7314150363582	1	100,50	54
749-1.1/4	7314150363544	1	63,21	54
749-1.1/8	7314150363520	1	54,78	54
749-1.11/16	7314150363612	1	106,71	54
749-1.13/16	7314150363636	1	123,63	54
749-1.15/16	7314150363650	1	132,68	54
749-1.3/16	7314150363537	1	59,87	54
749-1.3/4	7314150363629	1	120,52	54
749-1.3/8	7314150363568	1	84,70	54
749-1.5/16	7314150363551	1	81,86	54
749-1.5/8	7314150363605	1	106,71	54
749-1.7/16	7314150363575	1	86,37	54
749-1.7/8	7314150363643	1	123,63	54
749-1.9/16	7314150363599	1	102,49	54
749-1/2	7314150363421	1	50,91	54
749-10	7314150538386	10	15,66	54
749-11	7314150538362	10	15,66	54
749-11/16	7314150363452	1	53,95	54
749-13	7314150538348	10	4,53	54
749-13/16	7314150363476	1	53,95	54
749-14	7314150538324	10	17,00	54
749-15	7314150357543	1	57,76	54
749-15/16	7314150363490	1	54,78	54
749-16	7314150357550	1	51,20	54
749-17	7314150357567	1	64,45	54
749-18	7314150357574	1	51,20	54
749-19	7314150357581	1	64,45	54
749-2	7314150363667	1	137,20	54
749-2.1/4	7314150363698	1	143,40	54
749-2.1/8	7314150363674	1	143,40	54
749-2.3/16	7314150363681	1	143,40	54
749-2.3/4	7314150363728	1	167,69	54
749-2.3/8	7314150363704	1	150,20	54
749-2.5/8	7314150363711	1	167,69	54
749-20	7314150357598	1	53,58	54
749-21	7314150357604	1	65,78	54
749-22	7314150357611	1	65,78	54
749-23	7314150357628	1	58,95	54
749-24	7314150357635	1	59,72	54
749-25	7314150357642	1	60,14	54
749-26	7314150357659	1	74,51	54
749-27	7314150357666	1	73,51	54
749-3.1/8	7314150363735	1	239,94	54
749-3/4	7314150363469	1	53,95	54
749-3/8	7314150363407	1	50,00	54
749-5/8	7314150363445	1	53,95	54
749-7/16	7314150363414	1	50,00	54
749-7/8	7314150363483	1	53,46	54
749-9/16	7314150363438	1	53,73	54
7490	7314150052646	10	52,08	650
7490 CO	7314150052875	10	62,78	650
74P14-200	7314150416318	1	189,34	110
74P14-300	7314150416325	1	293,17	110
74P14-400	7314150416332	1	305,38	110
74P9-100	7314150416301	1	189,34	110
74P9-20	7314150416288	1	195,45	110
74P9-60	7314150416295	1	195,45	110
74PR-100	7314150416189	1	210,10	109
74PR-100A	7314150416196	1	210,10	109
74PR-20	7314150416158	1	195,45	109
74PR-200	7314150416202	1	213,77	109
74PR-300	7314150416219	1	256,52	109
74PR-400	7314150416226	1	299,27	109
74PR-60	7314150416165	1	205,21	109
74PR-60A	7314150416172	1	205,21	109
74PS-100	7314150416257	1	189,34	110
74PS-20	7314150416233	1	195,45	110
74PS-200	7314150416264	1	189,34	110
74PS-300	7314150416271	1	293,17	110
74PS-60	7314150416240	1	195,45	110
74S/H10	7314150218622	1	42,45	164
74S/H10-2P	7314150261635	1	16,98	164
74S/H12	7314150218639	1	56,56	164



74S/H12-2P	7314150261659	1	22,62	164
74S/H14	7314150218646	1	56,56	164
74S/H14-2P	7314150261666	1	22,62	164
74S/H17	7314150218653	1	56,56	164
74S/H17-2P	7314150261673	1	22,62	164
74S/H4	7314150218578	1	42,45	164
74S/H4-2P	7314150261543	1	16,98	164
74S/H5	7314150218585	1	42,45	164
74S/H5-2P	7314150261550	1	16,98	164
74S/H6	7314150218592	1	42,45	164
74S/H6-2P	7314150261567	1	16,98	164
74S/H7	7314150218608	1	42,45	164
74S/H7-2P	7314150261574	1	16,98	164
74S/H8	7314150218615	1	42,45	164
74S/H8-2P	7314150261611	1	16,98	164
74W14-200	7314150415700	1	293,17	106
74W14-300	7314150415717	1	329,81	106
74W14-400	7314150415724	1	390,89	106
74W9-100	7314150415687	1	230,87	106
74W9-15	7314150415656	1	244,31	106
74W9-200	7314150415694	1	293,17	106
74W9-25	7314150415663	1	243,09	106
74W9-50	7314150415670	1	230,87	106
74WR-100	7314150415540	1	244,06	106
74WR-100B	7314150469871	1	244,06	106
74WR-15	7314150415519	1	256,52	106
74WR-200	7314150415557	1	244,06	106
74WR-25	7314150415526	1	256,52	106
74WR-300	7314150415564	1	256,52	106
74WR-340	7314150415571	1	280,95	106
74WR-400	7314150415588	1	339,59	106
74WR-50	7314150415533	1	239,42	106
74WS-100	7314150415625	1	230,87	106
74WS-15	7314150415595	1	244,31	106
74WS-200	7314150415632	1	293,17	106
74WS-25	7314150415601	1	243,09	106
74WS-300	7314150415649	1	329,81	106
74WS-50	7314150415618	1	230,87	106
7590	7314150052660	10	52,25	650
7590 CO	7314150052882	10	68,41	650
7591	7314150197491	1	26,99	650
75EXT	7314150415311	1	238,20	111
75P1-1500	7314150415298	1	1.575,78	110
75P3-1000	7314150415281	1	1.453,62	110
75P3-650	7314150415267	1	1.087,17	110
75P3-800	7314150415274	1	1.191,00	110
75PS-650	7314150415328	1	1.062,74	110
75R1-1500	7314150415236	1	1.360,00	107
75R3-1000	7314150415229	1	1.453,62	107
75R3-650	7314150415205	1	1.087,17	107
75R3-800	7314150415212	1	1.215,43	107
75S-650	7314150415243	1	1.074,96	108
76R1-2000	7314150522378	1	2.050,00	108
76R3-1000	7314150422128	1	726,81	108
76R3-1500	7314150422135	1	1.535,32	108
76R3-600	7314150423118	1	671,85	108
76R3-800	7314150422111	1	696,28	108
76S-600	7314150423125	1	684,06	108
7710	7314151551445	1	76,83	89
7750	7314151096427	1	55,34	88
7750-SPARE	7314150187874	1	20,43	91
7750RN	7314151831240	1	52,45	88
7750RN-SPARE	7314150209361	1	17,62	91
7750SL	7314150197675	1	58,52	88
7750SL-SPARE	7314150210268	1	18,58	90
7751	7314150386949	10	43,97	90
7752	7314151096533	1	46,86	86
7754	7314151096557	1	18,09	87
7756	7314150489152	6	18,36	87
7758-10	7314150470891	1	29,03	87
7759	7314151096601	1	40,59	87
7760	7314151096618	1	12,84	87
7760W-3	7314150470907	10	11,19	87
7760W-6	7314150470914	10	12,44	87
7761	7314151096632	1	15,37	87
7762	7314151096649	1	19,01	87
7764	7314151096670	1	12,29	88
7765	7314151096687	1	10,24	81
7766	7314151096694	1	29,34	87
7767	7314153003577	1	24,17	82
7768	7314150128433	1	41,54	87
776EX-01	7314150386130	1	12,20	87
776EX-03	7314150386154	1	12,20	87
776EX-04	7314150386161	1	14,05	87
776EX-06	7314150386178	1	15,22	87
776EX-08	7314150386185	1	15,90	87
776EX-11	7314150386147	1	16,91	87
7772H	7314150476336	10	3,11	93
7773A	7314150512270	20	2,99	88
7800DM-10	7314151096991	10	6,40	92
7800DM-11	7314151097011	10	6,52	92
7800DM-12	7314151097035	10	6,90	92
7800DM-13	7314151097059	10	7,20	92
7800DM-14	7314151097073	10	7,58	92
7800DM-15	7314151097097	10	7,85	92
7800DM-16	7314151097110	10	8,00	92

		€			
7800DM-17	7314151097134	10	8,32	92	
7800DM-18	7314151097158	10	8,32	92	
7800DM-19	7314151097172	10	8,64	92	
7800DM-20	7314151097196	10	8,88	92	
7800DM-21	7314151097219	10	9,12	92	
7800DM-22	7314151097233	10	9,45	92	
7800DM-23	7314151097257	10	9,93	92	
7800DM-24	7314151097271	10	10,65	92	
7800DM-25	7314151097295	10	10,82	92	
7800DM-26	7314151097318	10	11,04	92	
7800DM-27	7314151097332	10	11,34	92	
7800DM-28	7314151097356	10	12,17	92	
7800DM-29	7314151097363	10	12,49	92	
7800DM-30	7314151097370	10	12,64	92	
7800DM-31	7314150464548	10	12,85	92	
7800DM-32	7314151097387	10	13,14	92	
7800DM-33	7314150169351	10	11,57	92	
7800DM-34	7314150169405	10	16,49	92	
7800DM-36	7314151097400	10	24,89	92	
7800DM-8	7314151830854	10	6,40	92	
7800DM-9	7314151830861	10	6,40	92	
7800DMV-10	7314150121656	10	24,68	502	
7800DMV-11	7314150121663	10	24,68	502	
7800DMV-12	7314150121670	10	24,68	502	
7800DMV-13	7314150121687	10	24,68	502	
7800DMV-14	7314150121694	10	24,54	502	
7800DMV-15	7314150121700	10	24,54	502	
7800DMV-16	7314150121717	10	25,23	502	
7800DMV-17	7314150121724	10	25,39	502	
7800DMV-18	7314150121731	10	25,00	502	
7800DMV-19	7314150121748	10	25,72	502	
7800DMV-20	7314150121755	10	26,10	502	
7800DMV-21	7314150121762	10	25,71	502	
7800DMV-22	7314150121779	10	25,87	502	
7800DMV-24	7314150121786	5	27,24	502	
7800DMV-27	7314150121793	5	28,08	502	
7800DMV-30	7314150121809	5	30,58	502	
7800DMV-32	7314150121816	5	31,73	502	
7800DMV-8	7314150121649	10	23,98	502	
7800DZ-1	7314151097561	10	11,04	92	
7800DZ-1.1/16	7314151097578	10	11,68	92	
7800DZ-1.1/2	7314150464562	10	11,22	92	
7800DZ-1.1/4	7314151097608	10	13,29	92	
7800DZ-1.1/8	7314151097585	10	12,42	92	
7800DZ-1.3/16	7314151097592	10	13,13	92	
7800DZ-1.3/8	7314150464586	10	11,65	92	
7800DZ-1.5/16	7314150166077	10	11,65	92	
7800DZ-1.7/16	7314150464609	1	12,12	92	
7800DZ-1/2	7314151097455	10	7,39	92	
7800DZ-11/16	7314151097493	10	8,55	92	
7800DZ-11/32	7314150465712	10	8,09	92	
7800DZ-13/16	7314151097523	10	9,45	92	
7800DZ-13/32	7314150464623	10	8,09	92	
7800DZ-15/16	7314151097554	10	10,96	92	
7800DZ-19/32	7314151097479	10	8,09	92	
7800DZ-25/32	7314151097516	10	9,12	92	
7800DZ-3/4	7314151097509	10	8,97	92	
7800DZ-3/8	7314151097431	10	6,55	92	
7800DZ-5/16	7314150464647	10	8,09	92	
7800DZ-5/8	7314151097486	10	8,32	92	
7800DZ-7/16	7314151097448	10	6,73	92	
7800DZ-7/8	7314151097530	10	9,77	92	
7800DZ-9/16	7314151097462	10	7,87	92	
7800SM-10	7314151097851	10	6,52	91	
7800SM-11	7314151097868	10	6,52	91	
7800SM-12	7314151097875	10	6,90	91	
7800SM-13	7314151097882	10	7,20	91	
7800SM-14	7314151097899	10	7,58	91	
7800SM-15	7314151097905	10	7,85	91	
7800SM-16	7314151097912	10	8,00	91	
7800SM-17	7314151097929	10	8,32	91	
7800SM-18	7314151097936	10	8,32	91	
7800SM-19	7314151097943	10	8,64	91	
7800SM-20	7314150166206	10	9,07	91	
7800SM-21	7314151097967	10	9,12	91	
7800SM-22	7314151097974	10	9,45	91	
7800SM-23	7314151097981	10	9,93	91	
7800SM-24	7314151097998	10	10,65	91	
7800SM-25	7314151098001	10	10,82	91	
7800SM-26	7314151830823	10	11,04	91	
7800SM-27	7314151098025	10	11,34	91	
7800SM-28	7314151830830	10	12,17	91	
7800SM-29	7314150166213	10	12,64	91	
7800SM-30	7314151098056	10	12,64	91	
7800SM-32	7314151098063	10	12,89	91	
7800SM-33	7314150167319	10	11,57	91	
7800SM-34	7314153011305	10	17,25	91	
7800SM-36	7314151098087	10	24,44	91	
7800SM-8	7314151830793	10	6,40	91	
7800SM-9	7314151830809	10	6,52	91	
7800SZ-1.3/16	7314150528387	10	7,79	92	
7800SZ-1/2	7314150528400	10	7,39	92	
7800SZ-11/16	7314150528424	10	5,41	92	
7800SZ-13/16	7314150528448	10	5,71	92	
7800SZ-3/4	7314150528462	10	5,61	92	
7800SZ-3/8	7314150528486	10	4,41	92	

		€			
7800SZ-7/16	7314150528509	10	4,58	92	
7800SZ-7/8	7314150528523	10	6,05	92	
7800SZ-9/16	7314150528547	10	4,64	92	
7800TORX-E10	7314150166084	1	10,40	93	
7800TORX-E11	7314150220359	1	10,40	93	
7800TORX-E12	7314153011800	1	10,40	93	
7800TORX-E14	7314153011756	1	10,40	93	
7800TORX-E16	7314153011763	1	10,56	93	
7800TORX-E18	7314153011770	1	10,56	93	
7800TORX-E20	7314153011787	1	11,13	93	
7800TORX-E24	7314153011794	1	12,23	93	
7800TORX-E8	7314150166091	1	9,25	93	
7800TORX/9	7314150469741	1	93,01	96	
7805DM-10	7314151822101	10	17,14	92	
7805DM-12	7314151098452	10	17,14	92	
7805DM-13	7314151098469	10	17,14	92	
7805DM-14	7314151098476	10	17,92	92	
7805DM-15	7314151098483	10	18,83	92	
7805DM-16	7314151098490	10	19,37	92	
7805DM-17	7314151098506	10	19,37	92	
7805DM-18	7314151098513	10	19,37	92	
7805DM-19	7314151098520	10	19,37	92	
7805DM-21	7314151098544	10	21,52	92	
7805DM-22	7314151098551	10	21,73	92	
7805DM-23	7314150313532	10	21,80	92	
7805DM-24	7314151098568	10	22,38	92	
7805DM-26	7314151098582	10	22,38	92	
7805DM-27	7314151098599	10	24,80	92	
7805DM-30	7314151098605	10	26,52	92	
7805DM-32	7314150220281	10	27,18	92	
7805DM-34	7314150488537	10	27,18	92	
7805DZ-1	7314150357758	10	20,34	93	
7805DZ-1.1/16	7314150357765	10	21,50	93	
7805DZ-1.1/2	7314150357833	10	44,78	93	
7805DZ-1.1/4	7314150357796	10	24,39	93	
7805DZ-1.1/8	7314150357772	10	24,11	93	
7805DZ-1.3/16	7314150357789	10	22,99	93	
7805DZ-1.3/8	7314150357819	10	28,04	93	
7805DZ-1.5/16	7314150357802	10	26,33	93	
7805DZ-1.7/16	7314150357826	10	44,78	93	
7805DZ-11/16	7314150357703	10	16,77	93	
7805DZ-13/16	7314150357727	10	18,65	93	
7805DZ-15/16	7314150357741	10	19,41	93	
7805DZ-3/4	7314150357710	10	16,77	93	
7805DZ-5/8	7314150357697	10	16,77	93	
7805DZ-7/8	7314150357734	10	18,82	93	
7805GPR-16	7314150503117	120	4,87	307	
7805GPR-21	7314150503124	100	5,30	307	
7805SM-10	7314153011312	10	17,47	91	
7805SM-11	7314150475926	10	17,47	91	
7805SM-12	7314153011329	10	17,47	91	
7805SM-13	7314153011336	10	17,47	91	
7805SM-14	7314153011343	10	18,20	91	
7805SM-15	7314153011350	10	19,16	91	
7805SM-16	7314153011367	10	19,66	91	
7805SM-17	7314153011374	10	19,66	91	
7805SM-18	7314153011381	10	19,66	91	
7805SM-19	7314153011398	10	19,66	91	
7805SM-20	7314153011404	10	20,11	91	
7805SM-21	7314153011411	10	21,91	91	
7805SM-22	7314153011428	10	22,08	91	
7805SM-23	7314153011435	10	22,78	91	
7805SM-24	7314153011442	10	22,78	91	
7805SM-25	7314153011459	10	22,00	91	
7805SM-26	7314153011466	10	22,78	91	
7805SM-27	7314153011473	10	25,24	91	
7805SM-28	7314153011480	10	23,54	91	
7805SM-29	7314153011497	10	25,12	91	
7805SM-30	7314153011503	10	26,99	91	
7805SM-32	7314153011527	10	29,20	91	
7805SM-34	7314153024251	10	29,20	91	
7805SZ-1.1/2	7314150357987	1	44,78	91	
7805SZ-1.1/4	7314150357949	1	24,39	91	
7805SZ-1.3/16	7314150357932	1	22,99	91	
7805SZ-1.3/8	7314150357963	1	28,04	91	
7805SZ-1.5/16	7314150357956	1	26,33	91	
7805SZ-1.7/16	7314150357970	1	44,78	91	
7806MD	7314150220335	1	103,61	76	
7807H	7314151232764	1	34,05	177	
7807TE	7314150313792	1	72,98	76	
7808H	7314151232771	1	34,05	177	
7808HM	7314150220434	1	110,36	96	
7809F-10	7314151830892	5	14,59	95	
7809F-8	7314151830885	5	14,31	95	
7809H	7314151232788	1	32,27	177	
7809HL	7314150128464	1	12,74	96	
7809M-10	7314151815608	1	14,08	96	
7809M-10-120	7314150509669	1	11,60	96	
7809M-12	7314151815615	1	14,39	96	
7809M-12-120	7314150509683	1	11,60	96	
7809M-14	7314151815622	1	14,42	96	
7809M-14-120	7314150509706	10	11,60	96	
7809M-17					

7809M-4



7809M-4	7314150214600	10	12,98	96
7809M-4-120	7314150509591	1	11,60	96
7809M-5	7314151815561	1	12,98	96
7809M-5-120	7314150509607	1	11,60	96
7809M-5-180	7314151830922	1	21,46	96
7809M-6	7314151815578	1	12,98	96
7809M-6-120	7314150509621	1	11,60	96
7809M-7	7314151815585	1	12,98	96
7809M-7-100	7314151830960	1	17,07	96
7809M-8	7314151815592	1	14,08	96
7809M-8-120	7314151830984	1	19,64	96
7809M-9	7314151830991	1	14,08	96
7809M/10	7314151831448	1	147,00	73
7809PH-2	7314151830908	1	12,46	95
7809PH-3	7314151830915	1	12,85	95
7809PH-4	7314153003423	1	12,85	95
7809PZ-2	7314153003430	1	12,23	95
7809PZ-3	7314153003447	1	12,91	95
7809TO	7314150220465	1	151,67	96
7809TORX-T20	7314151811730	1	14,73	95
7809TORX-T20-120	7314150509768	1	20,09	96
7809TORX-T25	7314151811747	1	14,73	95
7809TORX-T25-120	7314150509799	1	20,09	96
7809TORX-T27	7314151811754	1	14,73	95
7809TORX-T27-120	7314150509812	1	20,09	96
7809TORX-T30	7314151811761	1	14,73	95
7809TORX-T30-120	7314150509836	1	20,09	96
7809TORX-T40	7314151811778	1	17,19	95
7809TORX-T40-120	7314150220564	1	21,97	96
7809TORX-T45	7314151811785	1	17,19	95
7809TORX-T45-120	7314150220557	1	21,97	96
7809TORX-T50	7314151811792	1	17,19	95
7809TORX-T50-100	7314150220540	1	21,97	96
7809TORX-T55	7314151811808	1	21,52	95
7809TORX-T55-120	7314150509874	1	25,44	96
7809TORX-T60	7314151811815	1	21,52	95
7809TORX-T60-120	7314150509898	1	25,44	96
7809TORX-T70	7314150509744	10	21,53	95
7809TORX-T70-140	7314150220526	5	31,08	96
7809TORX/10	7314151831455	1	160,82	73
7809XZN-10	7314151831080	1	19,10	97
7809XZN-10-100	7314151831097	1	23,61	97
7809XZN-12	7314151831103	1	23,61	97
7809XZN-12-100	7314151831110	1	25,79	97
7809XZN-14	7314153004574	1	25,23	97
7809XZN-14-100	7314153004567	1	29,51	97
7809XZN-16	7314150220458	1	27,65	97
7809XZN-18	7314150314058	1	29,46	97
7809XZN-6	7314150214617	1	18,08	97
7809XZN-8	7314151831066	1	18,20	97
7809XZN-8-100	7314151831073	1	19,91	97
7809Z-1/2	7314153003515	1	13,84	96
7809Z-1/4	7314153003478	1	12,75	96
7809Z-17/32	7314150313785	1	14,31	96
7809Z-19/32	7314153003546	1	14,56	96
7809Z-3/16	7314153003461	1	12,75	96
7809Z-3/8	7314153003492	1	12,75	96
7809Z-5/16	7314153003485	1	12,75	96
7809Z-5/8	7314153003553	1	14,56	96
7809Z-7/16	7314153003508	1	13,11	96
7809Z-9/16	7314153003539	1	14,20	96
7809Z/10	7314153003560	1	142,09	73
7810MB	7314150220380	1	75,77	76
7810MH	7314150220373	1	75,77	76
7811DMV	7314150122134	1	534,04	504
7812	7314150502028	100	13,53	318
7814DS	7314150318964	1	225,13	73
7817DZS	7314150319008	1	264,01	74
7817DZS1	7314150389902	1	212,56	75
7818DS	7314150318971	1	273,56	73
7818DST	7314150319039	1	243,83	75
7818MHR	7314150218912	1	274,78	73
7818SST	7314150319046	1	254,94	75
7819DRN	7314151831547	1	359,36	74
782-U	7311518276447	1	6,69	308
7823	7314150218141	1	75,46	170
7823DZS	7314150319015	1	310,93	75
7825DST	7314150319060	1	307,42	75
7825MBP	7314150218929	1	328,87	74
7825MHP	7314150218943	1	328,80	74
7825SST	7314150319053	1	307,42	75
7827DST	7314150319077	1	370,65	76
783	7311518276034	1	13,58	326
7835 G-160	7314150050253	5	44,50	245
7847SS	7314150318995	1	565,69	74
7851-G	7314150124909	1	172,89	115
7851-M	7314150124893	1	154,49	115
7865	7311518276720	1	43,82	170
787-1.1/16	7314150363186	1	48,70	51
787-1.1/2	7314150363254	1	61,20	51
787-1.1/4	7314150363216	1	54,63	51
787-1.1/8	7314150363193	1	48,70	51
787-1.11/16	7314150363278	1	136,67	51
787-1.13/16	7314150363292	1	136,67	51
787-1.3/16	7314150363209	1	54,63	51
787-1.3/4	7314150363285	1	136,67	51



787-1.3/8	7314150363230	1	59,40	51
787-1.5/16	7314150363223	1	54,63	51
787-1.5/8	7314150363261	1	67,13	51
787-1.7/16	7314150363247	1	60,59	51
787-1.7/8	7314150363308	1	148,54	51
787-2	7314150363315	1	148,54	51
787-2.1/4	7314150363346	1	178,16	51
787-2.1/8	7314150363322	1	166,31	51
787-2.3/16	7314150363339	1	166,31	51
787-2.3/8	7314150363353	1	190,11	51
7888DM	7314151820923	1	368,78	74
789-1.1/2	7314150363896	1	68,47	55
789-1.1/4	7314150363858	1	59,54	55
789-1.1/8	7314150363841	1	54,78	55
789-1.13/16	7314150363933	1	91,08	55
789-1.3/4	7314150363926	1	91,08	55
789-1.3/8	7314150363872	1	63,12	55
789-1.5/16	7314150363865	1	63,12	55
789-1.5/8	7314150363919	1	78,58	55
789-1.7/16	7314150363889	1	68,47	55
789-1.9/16	7314150363902	1	78,58	55
789-2	7314150363940	1	98,83	55
789-2.1/4	7314150363957	1	110,75	55
789-2.3/8	7314150363971	1	138,13	55
789-2.5/16	7314150363964	1	133,36	55
789-2.8	7314150363742	1	63,12	55
789-30	7314150363759	1	80,13	55
789-32	7314150357673	1	84,14	55
789-34	7314150363766	1	67,87	55
789-36	7314150363773	1	90,84	55
789-38	7314150363780	1	75,02	55
789-40	7314150363797	1	84,55	55
789-41	7314150363803	1	111,02	55
789-42	7314150363810	1	84,55	55
789-46	7314150363827	1	123,58	55
789-50	7314150363834	1	110,15	55
7890	7314150052691	10	55,62	651
7890 CO	7314150052899	10	68,41	651
7891	7314150052714	10	54,77	651
7891 CO	7314150052905	10	62,48	651
7892	7314150052738	10	65,32	651
7892 CO	7314150291687	10	57,10	651
7893	7314150052769	10	53,55	652
7893K	7314150351428	10	53,65	652
7894	7314150197484	10	26,06	652
790450A	7314150214716	1	65,98	264
790455A	7314150214709	1	56,03	264
7992	7314150470921	5	150,02	654
7993M0170	8413345115353	1	106,91	182
7993M0190	8413345115377	1	106,91	182
7993M0220	8413345115391	1	121,65	182
7993M0270	8413345115414	1	123,41	182
7993S0050	8413345115070	1	44,05	177
7993S0060	8413345115094	1	40,23	177
7993S0080	8413345115117	1	40,23	177
7993S0100	8413345115131	1	42,69	177
7993S0120	8413345115155	1	42,69	177
7993S0140	8413345115179	1	44,05	177
7993S0170	8413345115193	1	44,05	177
7993S0180	7314150476855	1	44,05	177
7993S0190	8413345115216	1	44,05	177
7993T0120	8413345115230	1	53,60	180
7993T0140	8413345115254	1	58,91	180
7993T0170	8413345115278	1	58,91	180
7993T0190	8413345115292	1	58,91	180
7993T0220	8413345115315	1	70,48	180
7993T0240	8413345115339	1	70,48	180
7994S0200	7314150492954	1	21,12	177
7994S0250	7314150492947	1	21,78	177
7994S0270	7314150492930	1	22,45	177
7994S0300	8413345129305	1	23,07	177
7994S0400	8413345129312	1	23,07	177
7994S0450	8413345129329	1	23,07	177
7994S0500	8413345129336	1	23,07	177
7994S0550	8413345129343	1	24,40	177
7994S0600	8413345129350	1	26,99	177
7994S0700	7314150522583	1	27,00	177
800-1.5-50ESD	8412243589327	10	3,89	653
800-2-50ESD	8412243589341	10	5,92	653
800-2.5-50ESD	8412243589365	10	3,38	653
800-3-50ESD	8412243589389	10	3,21	653
801-0-50ESD	8412243589426	10	4,11	653
801-00-50ESD	8412243589402	10	4,79	653
801-1-75ESD	8412243589440	10	4,50	653
801-7ESD	8412243589280	1	39,86	653
8010SL-2P	7314150243853	1	13,04	498
801C	7314150402151	10	173,65	652
8020-2P	7314150246601	1	8,78	195
803-10-50ESD	8412243589648	10	7,58	653
803-15-75ESD	8412243589549	10	7,67	653
803-20-75ESD	8412243589563	10	7,73	653
803-6-50ESD	8412243589464	10	5,62	653
803-7-50ESD	8412243589488	10	5,86	653
803-7ESD	8412243589303	1	41,10	653
803-8-50ESD	8412243589501	10	5,93	653
803-9-50ESD	8412243589525	10	7,58	653

			€	
8030-2P	7314150246618	1	8,78	195
8040-2P	7314150246625	1	8,78	195
8040L-2P	7314150246670	1	12,53	196
8040SL-2P	7314150243877	1	13,70	498
8045LVDE	7314151509163	10	20,96	219
8045VDE	73141515137256	10	17,12	219
805-TS1-50ESD	8412243589587	10	8,35	653
805-TS4-50ESD	8412243589600	10	6,33	653
805-TS5-50ESD	8412243589624	10	8,90	653
8050SL-2P	7314150243884	1	13,70	498
8052	7314151318406	5	28,73	218
806-1-1	7311518003760	6	4,56	219
806-1-2	7314150183258	6	5,96	219
806-1-3	7314150183265	6	6,04	219
8060B0080	8413345018104	1	13,05	267
8060B0100	8413345018111	1	18,12	267
8060B0120	8413345018128	1	20,01	267
8060B0140	8413345018135	1	20,15	267
8060B0180	8413345018142	1	28,42	267
8060B0240	8413345018159	1	48,42	267
8060B0360	8413345018166	1	71,05	267
8060T0080	8413345018173	1	9,80	267
8060T0100	8413345018180	1	9,21	267
8060T0140	8413345018203	1	9,50	267
8060T0180	8413345018210	1	9,94	267
8060T0240	8413345018227	1	15,81	267
8060T0360	8413345018234	1	24,50	267
8069	7314150007028	5	22,33	39
8069 C	7314150007035	5	16,40	39
8069 C IP	7314150101634	5	15,90	39
8069 IP	7314150007042	50	21,62	39
8069-1	7314150239511	1	4,88	39
8069-2	7314150238590	1	2,97	39
8070	7314150007110	5	23,45	39
8070 C	7314150007127	5	16,83	39
8070 C IP	7314150101641	5	16,31	39
8070 IP	7314150007134	40	22,81	39
8070-1	7314150239528	1	5,65	39
8070-2	7314150238606	1	3,10	39
8070V	7314150121519	2	39,14	501
8070VL	7314150213511	1	47,79	501
8071	7314150007202	5	25,44	39
8071 C	7314150007219	5	19,13	39
8071 C IP	7314150101658	5	18,65	39
8071 IP	7314150007226	50	24,80	39
8071-1	7314150239535	1	5,24	39
8071-2	7314150238613	1	3,13	39
8071V	7314150121526	2	47,59	501
8071VL	7314150213535	1	55,77	501
8071VLT	7314150121564	1	157,67	501
8072	7314150007288	5	33,16	39
8072 C	7314150007295	5	23,20	39
8072 C IP	7314150101665	5	22,71	39
8072 IP	7314150007301	30	32,51	39
8072-1	7314150239542	1	5,44	39
8072-2	7314150238620	1	3,43	39
8072V	7314150121533	2	53,05	501
8072VL	7314150213542	1	65,75	501
8072VLT	7314150121571	1	176,30	501
8073	7314150007363	5	48,19	39
8073 C	7314150007370	5	30,54	39
8073 C IP	7314150101672	5	30,04	39
8073 IP	7314150007387	20	47,55	39
8073-1	7314150239559	1	6,28	39
8073-2	7314150238637	1	3,77	39
8073V	7314150121540	2	70,38	501
8073VL	7314150213559	1	86,29	501
8073VLT	7314150121588	1	192,08	501
8074	7314150007448	3	78,75	39
8074 C	7314150007455	3	51,31	39
8074 C IP	7314150101689	3	50,80	39
8074 IP	7314150007462	20	78,12	39
8074-1	7314150239566	1	10,20	39
8074-2	7314150238644	1	4,43	39
8074V	7314150121557	2	113,80	501
8075	7314150007523	3	123,74	39
8075 C	7314150007530	3	79,61	39
8075 C IP	7314150101696	3	79,13	39
8075 IP	7314150007547	10	123,08	39
8075-1	7314150239573	1	13,53	39
8075-2	7314150238651	1	4,95	39
808050	7314153017642	50	41,83	211
808050A	7314150127306	1	26,73	217
808050L	7314150128075	25	40,34	211
808050L-SP1	7314150129218	1	10,25	211
808050P	7314150128105	50	40,34	211
808050P-25	7314150165179	10	127,62	211
808050S	7314150128082	25	21,43	212
808050S-18	7314150128921	30	37,78	212
808050S-22	7314150128938	30	37,78	212
808050TORX	7314150127313	50	26,11	217
808050TS	7314150128099	1	21,43	211
808060	7314150243822	1	39,96	498
808061	7314150243839	5	100,89	498
808062	7314150243846	5	100,89	498
8100B0140	7314150263028	1	30,74	267

			€	
8100B0180	7314150263042	1	40,80	267
8100B0240	8413345018296	1	54,23	267
8100B0360	8413345099660	1	100,78	267
8100F0180	7314150263059	1	17,84	267
8100F0240	7314150263066	1	20,75	267
8100T0100	7314150263073	1	6,56	267
8100T0140	8413345018333	1	7,84	267
8100T0180	7314150263080	1	10,53	267
8100T0240	7314150263097	1	14,67	267
8100T0360	7314150263103	1	25,98	267
8100T0480	7314150263127	1	17,13	267
8110H-1/2	7314153015860	1	99,97	97
8120-1/2	7314150384884	12	60,28	97
8120-1/4	7314150384921	20	38,34	84
8120-3/8	7314150384914	10	46,69	89
813	7314150055852	1	6,00	649
8130	7314150050918	10	49,23	644
8130-50/SUPR SPRING	7314150111572	1	3,52	649
8131	7314150050925	10	26,21	644
8131 CO	7314150051519	10	71,50	644
8132	7314150050932	10	65,11	644
8133	7314150470945	10	49,81	644
8134	7314150470952	10	49,81	644
8135	7314150470969	10	49,81	644
8136	7314150470976	10	49,81	645
8137	7314150459728	10	49,81	645
8138	7314150361540	10	49,81	645
814	7314150055845	1	4,52	649
8140	7314150050949	10	51,44	644
8140 CO	7314150051533	10	72,45	644
8140M2	7314150470983	10	45,40	649
8140PS	7314150358472	10	36,70	649
8141	7314150050987	10	50,35	644
8141 CO	7314150051557	10	52,69	644
8141PS	7314150349425	10	84,11	649
8142	7314150051007	10	57,57	644
8142 CO	7314150051564	10	77,68	644
8143	7314150051021	10	52,17	644
8144	7314150051045	10	49,23	644
8144 CO	7314150051601	10	75,58	644
8145	7314150051052	10	71,75	644
8146	7314150051076	10	47,27	645
8147	7314150051083	10	66,11	645
8148	7314150051090	10	71,10	645
8148 CO	7314150051656	10	86,32	645
8149	7314150051106	10	132,53	648
8150	7314150051113	10	64,12	644
8150 CO	7314150051670	10	74,53	644
8150 J	7314150051137	10	106,66	654
8150 SK	7314150112814	10	71,02	654
8150-1/2	7314151105006	1	64,90	97
8150-1/2-SPARE	7314150187881	1	30,58	98
8150-1/2V	7314150121601	1	195,16	502
8150M2	7314150470990	10	56,07	649
8150PS	7314150358489	10	43,39	649
8150RN-1/2	7314151831202	1	62,68	97
8150RN-1/2-SPARE	7314150209378	1	18,94	98
8150SL	7314150197682	1	66,06	97
8150SL-SPARE	7314150210275	1	20,55	98
8151	7314150051199	10	54,72	644
8151 CO	7314150051694	10	52,31	644
8151-1/2	7314151105112	1	85,37	98
8152	7314150052097	10	70,17	644
8152-1/2	7314151105129	1	47,45	93
8153	7314150051205	10	27,76	644
8154	7314150052103	10	68,58	644
8154 CO	7314150052233	10	73,96	644
8154-1/2V	7314150121595	1	62,24	502
8154-11	7314150469161	10	19,02	93
8154PSP	7314150347704	10	55,68	650
8155	7314150052110	10	83,57	644
8156	7314150051212	10	70,35	645
8157	7314150052127	10	72,61	645
8157-10	7314150467273	1	94,59	93
8157-15	7314150469222	1	55,01	93
8157-24	7314150469246	1	86,50	93
8157-36	7314150469260	10	132,68	93
8158	7314150052134	10	80,45	645
8158-10	7314150471003	1	30,39	93
8158-15	7314150471010	1	32,45	93
816	7314150428182	1	9,70	649
8160	7314150051229	10	61,61	644
8160 CO	7314150051724	10	77,30	644
8160 J	7314150051250	10	125,97	654
8160 M2	7314150381906	10	74,40	649
8160-1/2V	7314150121618	1	46,61	502
8160-10	7314150469185	10	18,57	93
8160-3	7314150469208	10	12,50	93
8160-5	7314150469284	10	14,74	93
8160-B	7314150182565	1	27,68	94
8160/SPRING	7314150229888	1	3,96	649
8160PS	7314150358496	10	53,93	649
8160W-10	7314150471027	10	21,29	94
8160W-3	7314150471041	10	16,16	94
8160W-5	7314150471065	10	16,96	94
8161	7314150051328	10	65,15	644





8161 CO	7314150051748	10	83,74	644
8161PS	7314150361533	10	52,90	649
8162	7314150051335	10	75,68	644
8162-1/2V	7314150121625	1	49,91	502
8163	7314150051342	10	53,34	644
8163 CO	7314150051762	10	70,77	644
8164	7314150052141	10	85,62	644
8164-1/2	7314151105266	1	12,29	88
8165	7314150052158	10	100,61	644
8165 CO	7314150052288	10	115,10	644
8166	7314150459377	10	32,96	94
8166L	7314150476350	10	149,97	645
8167	7314153003584	1	28,35	88
8167L	7314150476367	10	173,60	645
8168	7314150128440	1	38,32	94
8168L	7314150347711	10	173,60	645
8171	7314150469307	10	16,97	94
8172	7314150469321	10	20,18	94
8174A	7314150476374	10	9,74	94
8178	7314150512065	10	15,66	93
8194-1/2	7314151831226	1	6,23	98
8195-KEY	7314150389810	50	21,39	94
8195-R	7314150389780	1	52,93	97
8195-SET	7314150389797	5	64,47	97
8195-SQ	7314150389803	25	5,68	98
8211	7314150101030	10	80,57	646
8220SL-2P	7314150243860	1	13,04	498
8223	7314150112685	4	47,00	247
8223 IP	7314150113149	4	46,33	247
8224	7314150000012	4	55,34	247
8224 IP	7314150101757	4	54,67	247
8224CIP	7314150103607	4	34,93	247
8225	7314150000029	4	75,65	247
8225 IP	7314150101764	4	74,98	247
8225CIP	7314150103614	4	46,61	247
8226	7314150115853	1	84,27	247
8231	7311518266509	4	49,64	247
8231 IP	7311518270285	4	48,97	247
8242-2P	7314150243686	1	8,87	195
8242L-2P	7314150246687	1	12,53	196
8247	7314150051397	10	84,26	646
8247 CO	7314150051809	10	124,81	646
8248	7314150051427	10	97,85	647
8248 CO	7314150051823	10	133,10	647
8248Q	7314150349364	10	86,40	648
8249	7314150349401	10	33,12	647
8252-2P	7314150243693	1	8,87	195
8252L-2P	7314150246694	1	12,53	196
8252XL-1P	7314150265985	1	11,22	197
833AJ-4	7311518286927	1	36,92	590
833AJ-5	7311518286934	1	38,34	590
833AJ-6	7311518286941	1	39,91	590
833FJ-4	7311518286965	1	42,15	590
833FJ-5	7311518286972	1	43,41	590
833FJ-6	7311518286989	1	45,13	590
833PJ-4	7311518286897	1	33,25	589
833PJ-5	7311518286903	1	41,32	589
833PJ-67	7311518286910	1	41,32	589
833SB-4	7311518286859	1	61,80	590
833SB-5	7311518286866	1	94,31	590
833SB-6	7311518286873	1	108,96	590
833SB-7	7311518286880	1	141,46	590
834V-2	7314150124992	1	126,25	589
834V-4	7311518286811	1	291,57	589
834V-5	7311518286828	1	391,80	589
834V-6	7311518286835	1	495,07	589
834V-7	7311518286842	1	643,88	589
84-PODGER	7314150307494	1	37,11	40
850-1	7311518292737	10	17,59	548
8501-10	7311518004828	1	31,99	141
8501-10F	7311518220945	1	34,26	141
8501-12	7311518004842	1	33,48	141
8501-12F	7311518220952	1	39,39	141
8501-13	7311518004859	1	36,49	141
8501-136-10-24C	7314150371471	1	22,18	141
8501-136-20-24C	7314150371488	1	24,65	141
8501-13F	7311518220969	1	38,83	141
8501-15	7311518004873	1	38,47	141
8501-150-10-24C	7314150403004	1	27,11	141
8501-15F	7311518220976	1	42,09	141
8501-16	7311518004880	1	46,93	141
8501-160-20-24C	7314150403011	1	28,35	141
8501-160-20-48XF	7314150402892	1	28,35	141
8501-165-20-24C	7314150403028	1	28,35	141
8501-165-20-48XF	7314150402908	1	29,58	141
8501-16F	7311518220983	1	51,30	141
8501-16SW	7314150258642	1	49,45	141
8501-17	7311518004897	1	46,67	141
8501-17F	7311518220990	1	53,07	141
8501-17S	7311518221027	1	52,94	142
8501-184-16-24	7314150402946	1	32,03	141
8501-184-16-40	7314150402953	1	33,88	141
8501-184-20-24C	7314150403042	1	30,81	141
8501-18S	7311518221034	1	56,21	142
8501-18SW	7311518221058	1	52,72	141
8501-190-30-24C	7314150403059	1	36,97	141



8501-190-30-60XF	7314150402960	1	40,05	141
8501-2	7311518004743	1	25,52	141
8501-210-30-48SW	7314150403066	1	78,86	141
8501-210-30-60XF	7314150402977	1	46,83	141
8501-216-60SW	7314150359448	1	54,70	141
8501-22	7311518178888	1	47,48	141
8501-22F	7311518221003	1	54,70	141
8501-23	7311518004958	1	48,02	141
8501-230-30-60XF	7314150402984	1	51,75	141
8501-235-30-60XF	7314150402991	1	52,98	141
8501-23F	7311518018887	1	55,39	141
8501-260-24SW	7314150359479	1	72,48	141
8501-260-30-80S	7314150403097	1	80,10	142
8501-260-40SW	7314150359462	1	67,78	141
8501-260-60SW	7314150359455	1	71,48	141
8501-28	7311518018894	1	60,97	141
8501-28F	7311518221010	1	63,51	141
8501-28S	7311518221041	1	83,97	142
8501-28SW	7311518221065	1	70,20	141
8501-28XF	7311518281946	1	70,27	141
8501-3	7311518004750	1	24,84	141
8501-30	7311518237479	1	80,24	141
8501-305-30-40SW	7314150403073	1	41,78	141
8501-305-30-60SW	7314150403080	1	45,60	141
8501-305-30-96S	7314150403103	1	53,73	142
8501-30F	7311518237462	1	82,59	141
8501-30S	7311518282240	1	108,12	142
8501-30SW	7311518282196	1	91,42	141
8501-30XF	7311518281984	1	91,15	141
8501-31	7311518237455	1	82,27	141
8501-31F	7311518237448	1	90,79	141
8501-4	7311518008079	1	25,64	141
8501-40	7311518282042	1	108,31	141
8501-4F	7311518220914	1	26,89	141
8501-4XF	7311518281786	1	28,29	141
8501-5	7311518004774	1	29,75	141
8501-5F	7311518220921	1	31,99	141
8501-7	7311518004798	1	29,47	141
8501-7F	7311518220938	1	31,53	141
8510SL-2P	7314150245758	1	20,31	498
8520SL-2P	7314150245765	1	20,31	498
86	7314150005376	1	277,02	39
86-1	7314150254996	1	8,06	39
86-2	7314150255009	1	6,78	39
8600-2P	7314150246564	1	8,72	195
8610-2P	7314150243648	1	8,72	195
8610L-2P	7314150246700	1	12,34	196
8610SL-2P	7314150243891	1	13,70	498
8620-2P	7314150243662	1	8,78	195
8620L-2P	7314150246717	1	12,34	196
8620SL-2P	7314150243907	1	13,70	498
8620XL-1P	7314150265947	1	11,22	197
8630-2P	7314150246571	1	8,78	195
8630XL-1P	7314150265961	1	11,22	197
864000010	8413345137638	1	20,40	553
864000020	7314150330171	1	11,63	553
864002450	8413345129022	50	66,34	553
864100010	8413345137621	1	11,73	553
864102400	8413345129015	1	63,72	553
865-1	7311518292744	10	19,40	548
869102500	8413345083669	6	31,58	578
869103000	8413345116640	6	39,62	578
869203000	8413345137508	6	30,35	578
87	7314150005406	3	282,88	39
87-1	7314150255016	1	10,12	39
87-2	7314150255023	1	7,11	39
8703-2P	7314150246632	1	8,99	196
8704-2P	7314150246649	1	8,99	196
8705-2P	7314150246656	1	8,99	196
8706-2P	7314150246663	1	8,99	196
8710SL-2P	7314150245772	1	20,31	498
8720SL-2P	7314150245789	1	20,31	498
874002000	8413345024938	5	9,96	605
874002500	8413345024945	5	10,91	605
874003000	8413345024952	5	12,31	605
874003500	8413345024969	5	13,64	605
874004000	8413345024976	5	17,15	605
874005000	8413345024983	5	20,45	605
874102000	8413345080989	6	15,96	605
874102500	8413345081009	5	16,80	605
874103000	8413345081023	5	17,95	605
874103500	8413345081047	4	19,20	605
874104000	8413345081061	5	21,97	605
874602000	8413345024990	5	8,34	605
874602500	8413345025003	5	9,26	605
874603000	8413345025065	5	10,41	605
874603500	8413345025072	5	11,84	605
874604000	8413345025089	5	14,17	605
874916X16	7314150489787	1	5,31	606
874918X18	7314150489800	1	5,31	606
874923X13	7314150489763	1	5,31	606
874926X7	7314150489749	1	5,31	606
876002000	8413345025119	10	8,98	606
876002500	8413345025126	5	9,37	606
877002000	8413345025140	25	16,37	606
8800-2P	7314150246588	1	8,72	195



8810-2P	7314150243655	1	8,72	195
8810L-2P	7314150246724	1	12,34	196
8810SL-2P	7314150243914	1	13,70	498
8820-2P	7314150243679	1	8,78	195
8820L-2P	7314150246731	1	12,34	196
8820SL-2P	7314150243921	1	13,70	498
8820XL-1P	7314150265954	1	11,22	197
8821MB	7314150220571	1	828,15	77
8830-2P	7314150246595	1	8,78	195
8830XL-1P	7314150265978	1	11,22	197
8840M	7314151105495	1	1.204,85	77
8845DM	7314151105525	1	574,59	77
8845NM	7314151810955	1	583,74	77
8900DM-19	7314151105730	1	17,79	99
8900DM-21	7314150166367	5	15,36	99
8900DM-22	7314151105754	1	18,31	99
8900DM-23	7314150166374	1	17,34	99
8900DM-24	7314151105778	1	19,61	99
8900DM-25	7314151105785	1	19,05	99
8900DM-26	7314150219797	1	17,19	99
8900DM-27	7314151105822	1	19,99	99
8900DM-28	7314151105846	1	20,97	99
8900DM-29	7314150219803	1	19,72	99
8900DM-30	7314151105884	5	22,40	99
8900DM-32	7314151105891	1	23,36	99
8900DM-33	7314150166398	1	22,99	99
8900DM-34	7314151838478	1	24,85	99
8900DM-35	7314150219810	1	22,99	99
8900DM-36	7314151105914	1	27,02	99
8900DM-37	7314150166404	1	27,70	99
8900DM-38	7314150219827	1	31,72	99
8900DM-40	7314150166411	1	34,12	99
8900DM-41	7314151105938	5	31,68	99
8900DM-42	7314150166428	1	34,11	99
8900DM-46	7314151105952	1	37,38	99
8900DM-47	7314150166435	1	35,06	99
8900DM-50	7314151105969	5	42,59	99
8900DM-52	7314150166442	1	44,66	99
8900DM-54	7314150166459	3	44,66	99
8900DM-55	7314151105983	1	51,26	99
8900DM-56	7314150166466	1	52,29	99
8900DM-60	7314151106003	5	56,98	99
8900DZ-1	7314151106058	1	19,74	99
8900DZ-1.1/16	7314151106065	1	20,39	99
8900DZ-1.1/2	7314151106133	1	28,97	99
8900DZ-1.1/4	7314151106096	1	23,63	99
8900DZ-1.1/8	7314151106072	1	21,38	99
8900DZ-1.11/16	7314150166282	1	33,86	99
8900DZ-1.13/16	7314151106188	1	37,86	99
8900DZ-1.3/4	7314151106171	1	37,86	99
8900DZ-1.3/8	7314151106119	1	25,63	99
8900DZ-1.5/16	7314151106102	5	25,63	99
8900DZ-1.5/8	7314151106157	1	32,63	99
8900DZ-1.7/8	7314151106195	1	43,12	99
8900DZ-1.9/16	7314150166299	1	33,47	99
8900DZ-13/16	7314150166305	1	16,33	99
8900DZ-15/16	7314151106034	1	19,58	99
8900DZ-2	7314151106201	1	43,12	99
8900DZ-2.1/16	7314150166312	1	43,01	99
8900DZ-2.1/4	7314150166329	1	44,90	99
8900DZ-2.1/8	7314150166336	1	43,02	99
8900DZ-2.3/16	7314150358670	1	48,95	99
8900DZ-2.3/8	7314150166350	1	54,09	99
8900DZ-3/4	7314150166381	1	12,52	99
8900DZ-31/32	7314150358663	1	22,56	99
8900DZ-7/8	7314150166473	1	19,83	99
8900SM-19	7314150166633	1	18,03	98
8900SM-22	7314151810795	1	18,03	98
8900SM-23	7314150219834	1	18,03	98
8900SM-24	7314151810801	5	19,35	98
8900SM-26	7314150219841	5	19,61	98
8900SM-27	7314151810818	5	19,99	98
8900SM-28	7314150166657	1	19,99	98
8900SM-29	7314150219858	1	22,40	98
8900SM-30	7314151810825	5	22,40	98
8900SM-32	7314151810832	5	23,36	98
8900SM-33	7314150166671	1	23,36	98
8900SM-34	7314151838461	1	24,85	98
8900SM-35	7314150166688	1	24,85	98
8900SM-36	7314151810849	5	27,02	98
8900SM-38	7314151810856	1	28,75	98
8900SM-41	7314151810863	5	31,68	98
8900SM-42	7314150219865	1	31,68	98
8900SM-46	7314151810870	1	37,38	98
8900SM-50	7314151810887	1	42,60	98
8900SM-55	7314151810894	1	51,25	98
8900SM-60	7314151810900	1	56,98	98
8900SZ-1	7314150166480	1	24,01	98
8900SZ-1.7/16	7314150166589	1	30,15	98
8900SZ-1.7/8	7314150166596	1	41,76	98
8900SZ-1.9/16	7314150166602	1	31,41	98
8900SZ-13/16	7314150166619	1	21,90	98
8900SZ-2	7314150166640	1	45,50	98
8900SZ-3/4	7314150166664	1	15,87	98
89049TM-1000	7314150415403	1	1.575,78	113
8905-TM	7314150125470	1	1.493,67	114



8910-2P	7314150243709	1	8,72	196
8910SL-2P	7314150243938	1	15,23	498
8915-2P	7314150243716	1	8,72	196
8915L-2P	7314150258765	1	13,35	196
8915SL-2P	7314150243945	1	15,23	498
8920-2P	7314150243723	1	8,78	196
8920L-2P	7314150258772	1	13,35	196
8920SL-2P	7314150243952	1	15,23	498
89222CR-1000	7314150415441	1	3.053,84	114
8925-2P	7314150243730	1	8,78	196
8925L-2P	7314150258789	1	13,35	196
8925SL-2P	7314150243968	1	15,23	498
8927-2P	7314150243747	1	8,78	196
8927L-2P	7314150263516	1	13,35	196
8930-2P	7314150243754	1	8,87	196
8930L-2P	7314150258796	1	13,35	196
8930SL-2P	7314150243976	1	15,23	498
8940-2P	7314150243761	1	8,87	196
894M-10	7314151833039	10	3,43	51
894M-100	7314151833305	1	319,36	51
894M-105	7314151833312	1	417,14	51
894M-11	7314151833046	10	3,52	51
894M-110	7314151833329	1	466,12	51
894M-115	7314151833336	1	528,69	51
894M-12	7314151833053	10	3,52	51
894M-120	7314151833343	1	556,07	51
894M-125	7314150132478	1	641,65	51
894M-13	7314151833060	10	3,52	51
894M-130	7314150132485	1	664,74	51
894M-135	7314150132492	1	745,28	51
894M-14	7314151833077	10	4,12	51
894M-15	7314151833084	10	4,27	51
894M-16	7314150139569	10	4,56	51
894M-17	7314151833091	10	3,52	51
894M-19	7314151833107	10	4,78	51
894M-21	7314150223220	5	5,14	51
894M-22	7314151833114	5	5,95	51
894M-24	7314151833121	5	7,17	51
894M-27	7314151833138	5	8,19	51
894M-30	7314151833145	5	9,65	51
894M-32	7314151833152	5	10,88	51
894M-34	7314150139583	1	18,09	51
894M-36	7314151833169	5	14,15	51
894M-38	7314151833176	1	22,06	51
894M-41	7314151833183	1	22,45	51
894M-46	7314151833190	1	25,40	51
894M-50	7314151833206	1	31,81	51
894M-55	7314151833213	1	37,58	51
894M-60	7314151833220	1	52,96	51
894M-65	7314151833237	1	63,53	51
894M-70	7314151833008	10	3,43	51
894M-75	7314151833244	1	74,20	51
894M-8	7314151833251	1	127,79	51
894M-80	7314151833015	10	3,43	51
894M-85	7314151833268	1	150,86	51
894M-9	7314151833275	1	184,14	51
894M-90	7314151833022	10	3,52	51
894M-95	7314151833282	1	205,94	51
8950NA-SO/2	7314151833299	1	313,27	51
8950RN/A	7314150521258	1	99,70	100
8951	7314151106782	1	129,06	100
8951-M	7314150124916	1	113,30	100
8952N/B	7314150180219	1	346,92	101
8953E-32	7314150509447	1	237,90	115
8954-15	7314150522774	1	23,43	99
8954A	7314151106812	1	77,97	99
8955N	7314150434114	1	69,22	99
8955N-SPARE	7314150434121	1	36,66	99
8955N/A	7314150434053	1	117,09	100
8955N/B	7314150434176	5	49,29	101
8957-19	7314150522781	1	92,44	100
8957A	7314150510580	1	32,96	100
8958A	7314151106836	1	94,25	99
895M-10-11	7314151832742	10	76,50	99
895M-10-13	7314151832759	10	92,95	99
895M-13-17	7314151832803	10	3,43	49
895M-17-19	7314151832827	10	3,43	49
895M-19-22	7314151832834	10	4,12	49
895M-19-24	7314151832841	5	5,08	49
895M-22-24	7314151832858	5	6,22	49
895M-24-27	7314151832865	5	7,12	49
895M-24-30	7314151832872	5	7,46	49
895M-27-32	7314151832889	5	9,89	49
895M-30-32	7314151832896	5	11,74	49
895M-30-36	7314151832902	1	14,20	49
895M-32-36	7314151832919	1	19,45	49
895M-36-41	7314151832926	1	20,02	49
895M-41-46	7314151832933	1	20,02	49
895M-46-50	7314151832940	1	27,73	49
895M-50-55	7314151832957	1	33,74	49
895M-55-60	7314151832964	1	40,54	49
895M-6-7	7314151832711	10	53,45	49
895M-65-70	7314151832971	1	67,42	49
895M-8-10	7314151832735	10	3,47	49
			132,69	49
			3,14	49



895M-8-9



895M-8-9	7314151832728	10	3,14	49
8960-16	7314150492855	12	48,62	100
8960-8	7314150492862	1	39,03	100
8963	7314150181087	1	39,56	99
8966	7314151106898	1	94,65	100
8967	7314153003591	1	32,65	94
8967/S3	7314153003607	1	85,14	82
8971	7314150492879	1	26,68	100
8972	7314150492886	1	29,82	100
9-12-51/3806-KP	7311518044558	5	18,52	634
9-462-14-0-0	7311518020873	5	56,83	35
9-467-00-0-0	7311518020897	1	43,24	35
9-469-00-0-0	7311518020903	1	16,46	35
9-484-3.2-10	7311518193348	10	1,78	35
9-484-3.2-1P	7311518193522	10	3,07	35
9-484-5.2-10	7311518193355	10	1,78	35
9-484-5.2-1P	7311518193331	10	3,07	35
9-485-04-10	7314150271672	10	3,07	36
9-485-04-1P	7314150271665	10	3,07	36
9-485-05-10	7314150271696	10	3,07	36
9-485-05-1P	7314150271689	10	3,07	36
9-485-06-10	7311518193508	10	3,34	36
9-485-06-1P	7311518193492	20	4,50	36
9-485-09-10	7311518193386	10	3,34	36
9-485-09-1P	7311518193362	20	4,50	36
9-485-13-10	7311518193393	10	3,34	36
9-485-13-1P	7311518193379	1	4,50	36
9-486-04-10	7311518193430	10	3,34	36
9-486-04-1P	7311518193409	20	4,50	36
9-486-05-10	7311518193461	10	3,34	36
9-486-05-1P	7311518193447	20	4,50	36
9-486-07-10	7311518249373	10	3,35	36
9-486-07-1P	7311518249359	20	4,50	36
9-486-08-10	7311518270933	10	4,49	36
9-486-C-10	7311518209599	10	3,19	36
9-486-C-1P	7311518209605	10	4,26	36
9-488-02-10	7311518194772	10	2,54	35
900T-020-100	7314153018106	5	10,41	216
900T-025-100	7314153018113	5	10,41	216
900T-030-100	7314153018120	5	10,41	216
900T-040-150	7314153018137	5	11,63	216
900T-050-150	7314153018144	5	12,09	216
900T-060-200	7314153018151	5	12,85	216
900T-080-200	7314153018168	5	14,09	216
900T-100-200	7314153018175	5	15,61	216
901T-006-100	7314153018182	5	7,54	216
901T-007-100	7314153018199	5	7,54	216
901T-008-100	7314153018205	5	7,54	216
901T-009-100	7314153018212	5	7,54	216
901T-010-100	7314153018229	5	10,69	216
901T-015-150	7314153018236	5	10,88	216
901T-020-150	7314153018243	5	10,88	216
901T-025-150	7314153018250	5	11,93	216
901T-027-150	7314153018267	5	11,93	216
901T-030-200	7314153018274	5	12,85	216
901T-040-200	7314153018281	5	13,45	216
901T-045-200	7314153018298	5	13,45	216
901T-050-200	7314153018304	5	13,45	216
9029	7314153010612	5	30,52	38
9029 C	7314153010629	5	35,78	38
9029-1	7314150239580	1	5,99	39
9029-2	7314150238668	1	3,43	39
9029-T	7314150189076	5	35,20	38
9029T-1	7314150312139	1	13,35	39
902T-050-150	7314153018311	5	12,49	216
902T-055-150	7314153018328	5	12,49	216
902T-060-150	7314153018335	5	13,32	216
902T-070-175	7314153018342	5	14,09	216
902T-080-175	7314153018359	5	14,36	216
902T-090-175	7314153018366	5	14,36	216
902T-100-175	7314153018373	5	15,30	216
902T-110-175	7314153018380	5	15,30	216
902T-120-175	7314153018397	5	17,14	216
902T-130-175	7314153018403	5	18,06	216
9031	7314150110988	5	33,17	38
9031 C	7314150113507	5	38,37	38
9031 P-1	7314150266302	1	8,40	39
9031-1	7314150239597	1	5,80	39
9031-8224	7314150321193	3	86,43	258
9031-T	7314150131648	5	40,96	38
9031P	7314150187539	5	35,94	38
9031T-1	7314150312146	1	13,46	39
9033	7314150181414	5	43,27	38
9033-1	7314150353804	1	12,66	39
9035	7314150181421	5	62,72	38
9035-1	7314150353811	1	14,15	39
903T-1	7314153018410	1	76,66	215
903T-2	7314153018427	1	70,74	215
903T-3	7314153018434	1	87,63	216
9045-B-200	7311518012175	6	25,55	544
9045-B-250	7311518012182	6	27,04	544
9045-B-300	7311518012199	6	29,49	544
9045-B-400	7311518178123	1	34,39	544
9048-200	7314150138159	10	20,53	544
9048-250	7314150138166	10	21,24	544
9048-300	7314150138173	10	24,26	544



9048-350	7314150180349	10	24,29	544
9048-400	7314150138180	10	25,71	544
904T-060-150	7314153019837	5	19,21	217
905T-060-100	7314153019844	5	16,08	216
9070	7314150100170	5	29,11	38
9070 P	7314150103416	5	32,59	38
9070 P-1	7314150239610	1	8,16	39
9070 PC	7314150103423	5	29,05	38
9070C	7314150100187	5	26,36	38
9071	7314150100194	5	31,61	38
9071 P	7314150103430	5	34,79	38
9071 P-1	7314150239627	1	7,97	39
9071 PC	7314150103447	5	31,11	38
9071C	7314150100200	5	28,23	38
9072	7314150055609	5	41,16	38
9072 C	7314150055616	5	36,36	38
9072 P	7314150056354	5	44,61	38
9072 P-1	7314150239634	1	8,77	39
9072 PC	7314150056361	5	39,06	38
9073	7314150101702	5	59,86	38
9073 C	7314150101719	3	53,08	38
9073 P	7314150101726	5	63,33	38
9073 P-1	7314150239641	1	9,95	39
9073 PC	7314150101733	3	55,77	38
91-023-5P	7311518032593	1	4,41	138
91-027-5P	7311518032616	1	5,79	138
91-143-100P	7311518224363	1	111,52	138
91-143-25P	7311518266578	1	27,85	138
91-143-5P	7311518032630	1	6,10	138
91-148-5P	7311518032654	1	7,15	138
91-223-5P	7311518032661	1	6,42	138
91-226-5P	7311518032685	1	8,99	138
91-233-5P	7311518260057	1	8,68	138
91-243-5P	7311518032692	1	7,21	138
91-2PW-5P	7311518260163	1	10,51	138
91-3PM-5P	7311518260156	1	8,50	138
91-412-5P	7311518260040	1	13,52	138
91-433-5P	7311518260101	1	13,03	138
91-434-5P	7311518260026	1	17,87	138
91-443-5P	7311518032722	1	18,67	138
91-444-5P	7311518260033	1	19,10	138
91-4PMM-5P	7311518260170	1	13,30	138
91-502-5P	7311518032746	1	7,21	138
91-512-25P	7311518266592	1	35,13	138
91-512-5P	7311518032753	1	8,84	138
91-517-5P	7311518032777	1	7,95	138
91-522-5P	7311518032784	1	7,46	138
91-611-5P	7311518260071	1	9,61	138
91-612-5P	7311518032814	1	7,77	138
91-622-5P	7311518260088	1	9,02	138
91-623-5P	7311518260064	1	13,52	138
91-7V1-5P	7311518260118	1	16,53	138
91-METAL-10P	7314150449477	1	18,82	138
91-MIXED-10P	7314150449491	1	18,02	138
91-WOOD-10P	7314150449446	1	16,42	138
91C	7314150182381	5	27,40	40
92-001-1P	7314150474998	90	32,38	140
92-106-1P	7314150474899	90	26,15	139
92-113-1P	7314150474912	90	23,61	140
92-118-1P	7314150474950	90	46,52	140
92-133-1P	7314150474134	70	18,26	139
92-133-3P	7314150474158	46	47,92	139
92-136-1P	7314150474783	20	29,67	141
92-136-G120-5P	7314150498079	10	3,99	141
92-136-G240-5P	7314150498116	10	3,99	141
92-136-G40-5P	7314150497997	10	3,99	141
92-136-G80-5P	7314150498031	10	3,99	141
92-137-1P	7314150475070	50	12,29	141
92-137-G120-5P	7314150498093	10	3,99	141
92-137-G240-5P	7314150498130	10	3,99	141
92-137-G40-5P	7314150498017	10	3,99	141
92-137-G80-5P	7314150498055	10	3,99	141
92-157-1P	7314150474820	70	14,84	139
92-160-1P	7314150474172	70	17,12	139
92-160-3P	7314150474196	46	52,49	139
92-165-1P	7314150475018	90	10,56	140
92-166-1P	7314150474974	50	78,90	140
92-174-1P	7314150474936	90	46,52	140
92-205-1P	7314150474219	70	20,54	139
92-205-3P	7314150474356	46	58,53	139
92-221-1P	7314150474721	70	18,26	139
92-222-1P	7314150474592	70	18,83	139
92-222-3P	7314150474370	46	53,66	139
92-223-1P	7314150474684	70	19,40	139
92-223-3P	7314150474400	46	51,91	139
92-225-1P	7314150474707	70	15,40	139
92-226-1P	7314150475032	90	19,69	140
92-228-1P	7314150474745	70	17,12	139
92-229-1P	7314150474769	70	17,12	139
92-236-1P	7314150474806	70	29,67	139
92-245-1P	7314150475056	90	30,64	140
92-251-1P	7314150474868	70	25,36	140
92-WM-SET-8P	7314150486830	34	119,92	140
9210	7311518278182	1	249,92	640
9210-1	7311518278212	1	54,23	640
9210-10	7311518278229	1	101,79	640



9210-1060177	7311518295424	1	0,90	641
9210-1060238	7311518295394	20	0,47	641
9210-1230219	7311518295387	20	6,78	641
9210-1230235	7311518295325	1	7,85	640
9210-1320281	7311518295431	10	9,03	641
9210-1640142	7311518295356	1	8,45	640
9210-1690148	7311518295332	1	19,28	640
9210-1700118	7311518295363	1	40,84	641
9210-1710266	7311518295417	1	66,75	641
9210-1720100	7311518295295	1	11,14	640
9210-1730107	7311518295349	10	13,41	640
9210-1770106	7311518295370	10	5,62	641
9210-1830137	7311518295400	1	8,95	641
9210-20	7311518278236	1	13,99	640
92C	7314150182398	5	31,24	40
93C	7314150182404	5	37,07	40
94C	7314150182411	5	47,37	40
9500DZ-1.13/16	7314150227501	1	40,11	101
9500DZ-1.5/8	7314150227495	1	34,42	101
9500DZ-1.7/8	7314150227518	1	40,11	101
9500DZ-2	7314150227525	1	52,67	101
9500DZ-2.1/2	7314150227570	1	60,61	101
9500DZ-2.1/4	7314150227556	1	52,67	101
9500DZ-2.1/8	7314150227532	1	52,67	101
9500DZ-2.15/16	7314150227617	1	82,35	101
9500DZ-2.3/16	7314150227549	1	52,67	101
9500DZ-2.3/4	7314150227600	1	68,91	101
9500DZ-2.3/8	7314150227563	1	60,61	101
9500DZ-2.5/8	7314150227594	1	70,22	101
9500DZ-2.9/16	7314150227587	1	60,61	101
9500DZ-3	7314150227624	1	94,61	101
9500DZ-3.1/8	7314150227631	1	94,61	101
9500SM-41	7314153013699	1	46,68	101
9500SM-46	7314153013705	1	54,44	101
9500SM-50	7314153013712	1	60,22	101
9500SM-54	7314153013729	1	64,18	101
9500SM-55	7314153013736	1	68,55	101
9500SM-58	7314153013743	1	74,92	101
9500SM-60	7314153013750	1	83,73	101
9500SM-63	7314153013767	1	93,85	101
9500SM-65	7314153013774	1	100,08	101
9500SM-67	7314153013781	1	106,59	101
9500SM-70	7314153013798	1	112,44	101
9500SM-71	7314153013804	1	118,34	101
9500SM-75	7314153013811	1	125,85	101
9500SM-77	7314153013828	1	133,85	101
9500SM-80	7314153013835	1	143,32	101
9500SM-82	7314153013842	1	152,81	101
9505-3400	7314150125517	1	3.890,67	114
9505-TM	7314150125487	1	1.493,67	114
95155B-3000	7314150415410	1	4.336,45	114
9525-10	7311518031817	1	18,60	156
9525-3400	7314150125524	1	7.208,79	114
9525-7	7311518031800	1	14,62	156
9525CR-4000	7314150415465	1	4.873,93	114
9526B-4500	7314150415427	1	4.519,69	114
9527CR-2000	7314150415458	1	3.359,23	114
9528-MD-15-45	7311518007447	10	40,34	155
9540DZ	7314150414048	1	1.358,07	78
9540DZL	7314150414055	1	1.858,94	78
9540MB	7314153014108	1	1.154,73	77
9540MBL	7314153014115	1	1.707,50	77
9550N	7314150424160	1	263,03	102
9550N-SPARE	7314150424153	1	73,95	102
9550N/A	7314150424146	1	215,72	102
9550N/B	7314150424788	1	53,93	102
9555	7314153014047	1	100,07	101
9555AB	7314153014061	1	46,75	101
956	7314150025190	1	5,42	572
9560AB	7314153014078	1	75,71	101
9563AB	7314153014085	1	96,99	101
9565AB	7314153014092	1	50,59	102
9566A	7314150220618	1	88,59	101
9572	7314150178599	5	48,19	40
9572-200	7311518004231	20	25,52	544
9572-250	7311518004248	20	27,07	544
9574-200	7314150138197	10	20,86	544
9574-250	7314150138203	10	21,40	544
9574-300	7314150180356	10	22,65	544
9575-250	7314150185894	6	31,63	544
95C	7314150182428	1	79,28	40
960100010	8413345031073	1	37,08	461
960100020	8413345031080	1	40,16	461
960100030	8413345031097	1	43,65	461
960100050	8413345031103	1	51,36	461
960100060	8413345031110	1	55,58	461
9625-6.35QC	7314150441716	1	27,11	156
9625-9500	7314150125555	1	6.437,50	114
96255CR-7000	7314150415489	1	6.101,57	114
9626-10	7314150388844	1	16,43	154
9626-11	7314150388851	1	16,71	154
9626-12	7314150388868	1	17,08	154
9626-13	7314150388875	1	17,52	154
9626-14	7314150388882	1	18,05	154
9626-15	7314150444526	1	18,85	154
9626-16	7314150388899	1	20,67	154



9626-18	7314150388905	1	26,38	154
9626-20	7314150388912	1	29,90	154
9626-22	7314150388929	1	33,42	154
9626-23	7314150388936	1	35,04	154
9626-24	7314150388943	1	36,63	154
9626-25	7314150388950	1	38,31	154
9626-26	73141503024237	1	39,98	154
9626-28	7314150388967	1	47,19	154
9626-30	7314150388974	1	67,56	154
9626-32	7314150388981	1	67,56	154
9626-35	7314150444533	1	67,56	154
9626-6	7314150388806	1	14,70	154
9626-7	7314150388813	1	15,11	154
9626-8	7314150388820	1	15,48	154
9626-9	7314150388837	1	16,07	154
9627-10-460	7314150389018	1	25,91	154
9627-12-460	7314150389025	1	26,24	154
9627-14-460	7314150389032	1	28,26	154
9627-16-460	7314150389049	1	29,60	154
9627-18-460	7314150389056	1	34,32	154
9627-20-460	7314150389063	1	38,69	154
9627-22-460	7314150389070	1	40,37	154
9627-24-460	7314150389087	1	43,75	154
9627-26-460	7314150389094	1	47,10	154
9627-28-460	7314150389100	1	48,78	154
9627-30-460	7314150389117	1	59,70	154
9627-32-460	7314150389124	1	67,28	154
9627-6-460	7314150388998	1	25,23	154
9627-8-460	7314150389001	1	25,58	154
9629-10	7314150388479	1	6,01	155
9629-12	7314150388486	1	6,01	155
9629-13	7314150440238	1	5,70	155
9629-14	7314150388493	1	6,38	155
9629-16	7314150388509	1	6,38	155
9629-17	7314150440245	1	6,38	155
9629-18	7314150388516	1	6,38	155
9629-19	7314150440252	1	6,38	155
9629-20	7314150388523	1	6,95	155
9629-22	7314150388530	1	6,95	155
9629-24	7314150388547	1	6,95	155
9629-25	7314150388554	1	6,95	155
9629-26	7314150388561	1	6,59	155
9629-28	7314150388578	1	10,85	155
9629-30	7314150388585	1	10,89	155
9629-32	7314150388592	1	10,94	155
9629-35	7314150440269	1	10,75	155
9629-36	7314150388608	1	11,64	155
9629-38	7314150388615	1	12,78	155
9629-40	7314150388622	1	12,78	155
9629-6	7314150388417	1	7,07	155
9629-8	7314150388462	1	5,28	155
9629-SET-8	7314150441648	12	30,81	155
9631-10-400	7314150388684	1	10,17	155
9631-12-400	7314150388691	1	11,28	155
9631-13-400	7314150447572	1	8,80	155
9631-14-400	7314150388707	1	9,64	155
9631-16-400	7314150388714	1	10,62	155
9631-18-400	7314150388721	1	11,97	155
9631-19-400	7314150447589	1	10,84	155
9631-20-400	7314150388738	1	11,97	155
9631-22-400	7314150388745	1	13,85	155
9631-24-400	7314150388752	1	14,87	155
9631-25-400	7314150432066	1	14,50	155
9631-28-400	7314150388776	1	18,04	155
9631-30-400	7314150388783	1	19,10	155
9631-32-400	7314150388790	1	21,62	155
9631-35-400	7314150447596	1	19,69	155
9631-38-400	7314150447602	1	19,83	155
9631-6-400	7314150388646	1	9,67	155
9631-8-400	7314150388677	1	9,67	155
9646-10	7314150388264	1	6,58	155
9646-10-250	7314150388387	1	7,09	155
9646-11	7314150388288	1	7,61	155
9646-12	7314150388295	1	9,70	155
9646-12-250	7314150388400	1	10,23	155
9646-13	7314150388301	1	10,37	155
9646-14	7314150388318	1	12,11	155
9646-15	7314150388325	1	12,82	155
9646-16	7314150388332	1	12,82	155
9646-18	7314150388349	1	19,06	155
9646-20	7314150388356	1	19,06	155
9646-3	7314150388189	1	3,46	155
9646-4	7314150388202	1	3,81	155
9646-5	7314150388219	1	4,15	155
9646-6	7314150388226	1	4,50	155
9646-6-250	7314150388363	1	5,02	155
9646-7	7314150388233	1	4,85	155
9646-8	7314150388240	1	5,55	155
9646-8-250	7314150388370	1	6,07	155
9646-9	7314150388257	1	6,07	155
9646-SET-5	7314150441686	1	10,64	155
9646-SET-8	7314150441693	1	13,80	155
9656-SET-6	7314150486953	1	65,31	155
96C	7314150134120	1	150,69	40
97-1	7314150366637	1	47,62	117
97-1/2	7314150366545	1	28,83	117





97-1/4	7314150366507	1	28,83	117
97-10	7314150366286	1	27,56	117
97-11	7314150366293	1	27,56	117
97-11/16	7314150366583	1	28,83	117
97-12	7314150366309	1	27,56	117
97-13	7314150366316	1	27,56	117
97-13/16	7314150366606	1	45,11	117
97-14	7314150366323	1	27,55	117
97-15	7314150366330	1	27,55	117
97-15/16	7314150366620	1	47,62	117
97-16	7314150366347	1	27,56	117
97-17	7314150366354	1	27,56	117
97-17/32	7314150366552	1	28,83	117
97-18	7314150366361	1	27,56	117
97-19	7314150366378	1	27,56	117
97-21	7314150366385	1	46,20	117
97-22	7314150349722	1	53,22	117
97-24	7314150357048	1	53,22	117
97-27	7314150366392	1	48,76	117
97-3/4	7314150366590	1	28,83	117
97-3/8	7314150366521	1	28,83	117
97-30	7314150366408	1	47,62	117
97-32	7314150366415	1	47,62	117
97-5/16	7314150366514	1	28,83	117
97-5/8	7314150366576	1	28,83	117
97-7	7314150366255	1	27,56	117
97-7/16	7314150366538	1	28,83	117
97-7/8	7314150366613	1	45,11	117
97-8	7314150366262	1	27,56	117
97-9	7314150366279	1	27,56	117
97-9/16	7314150366569	1	28,83	117
9710-10-175	7314151785789	5	11,55	217
9710-3.5-75	7314151785192	10	5,45	217
9710-5.5-100	7314151785352	10	7,24	217
9710-6.5-125	7314151785437	10	8,36	217
9710-8-150	7314151785512	5	9,64	217
9710/S6	7314151802301	1	52,16	217
9715-14-250	7314153010148	5	44,67	218
9733	7314150103256	1	386,68	257
9778-1	7314151793524	10	7,85	217
9778-2	7314151793531	10	10,73	217
9778-3	7314151793548	5	14,48	217
9778PZD-1	7314151823535	10	8,19	217
9778PZD-2	7314151823542	10	11,16	217
97C	7314150128211	1	294,44	40
98-1/2	7314150367481	1	30,08	118
98-1/4	7314150367443	1	30,08	118
98-10	7314150367320	1	30,08	118
98-11	7314150367337	1	30,08	118
98-11/16	7314150367511	1	30,08	118
98-12	7314150367344	1	30,08	118
98-13	7314150367351	1	30,08	118
98-13/16	7314150367535	1	31,33	118
98-14	7314150367368	1	30,08	118
98-15	7314150367375	1	30,08	118
98-16	7314150367382	1	30,08	118
98-17	7314150367399	1	30,08	118
98-18	7314150367405	1	30,08	118
98-19	7314150367412	1	30,08	118
98-21	7314150367429	1	30,08	118
98-22	7314150367436	1	30,08	118
98-3/4	7314150367528	1	30,08	118
98-3/8	7314150367467	1	30,08	118
98-5/16	7314150367450	1	30,08	118
98-5/8	7314150367504	1	30,08	118
98-7	7314150367290	1	30,08	118
98-7/16	7314150367474	1	30,08	118
98-7/8	7314150367542	1	31,33	118
98-8	7314150367306	1	30,08	118
98-9	7314150367313	1	30,08	118
98-9/16	7314150367498	1	30,08	118
981001100	7314150219902	1	1.539,57	450
982000170	7314150219926	1	574,17	464
982000320	7314150219919	1	574,17	464
982000350	7314150219933	1	647,02	464
983000320	7314150219940	1	525,98	441
983100320	7314150219964	1	562,20	441
984010320	7314150219971	1	814,01	441
9841	7314150107445	1	176,37	465
9848	7314150111015	1	159,03	465
98505	7314150216321	5	33,26	215
9852	7314150114092	1	370,64	465
9853	7314150103287	1	80,54	258
9855	7314150111848	1	100,74	655
9857	7314150114283	1	78,72	655
9858	7314150111862	1	29,25	655
9859	7314150113057	1	67,60	655
9860	7314150522859	1	154,72	655
9861	7314150522873	1	68,89	655
9862	7314150522897	1	54,46	655
9863	7314150522910	1	92,23	655
9873	7314150058082	1	54,35	258
9883	7314150043293	1	142,23	571
9897	7314150058068	1	136,33	259
9897G/3	7314150470020	1	81,99	259
9897S/3	7314150470044	1	92,80	503



99-1/2	7314150368150	1	33,84	118
99-10	7314150368013	1	31,33	119
99-11	7314150368020	1	31,33	119
99-11/16	7314150368181	1	35,08	119
99-12	7314150368037	1	31,33	119
99-13	7314150368044	1	31,33	119
99-14	7314150368051	1	31,33	119
99-16	7314150368068	1	32,57	119
99-17	7314150368075	1	32,57	119
99-18	7314150368082	1	32,57	119
99-19	7314150368099	1	32,57	119
99-21	7314150368105	1	32,57	119
99-22	7314150368112	1	32,57	119
99-24	7314150368129	1	36,34	119
99-3/4	7314150368198	1	35,08	119
99-3/8	7314150368136	1	33,84	118
99-5/8	7314150368174	1	33,84	119
99-7/16	7314150368143	1	33,84	118
99-9/16	7314150368167	1	33,84	119
9938	7314150056491	1	216,20	251
9A-14	7314150368204	1	58,89	119
9B-1/4	7314150366071	1	60,13	116
9B-5/16	7314150366088	1	81,44	116
9F-1/2	7314150366194	1	40,09	116
9F-1/4	7314150366170	1	38,85	116
9F-3/8	7314150366187	1	38,85	116
9P-1/2	7314150366057	1	88,96	116
9P-1/4	7314150366033	1	83,96	116
9P-3/8	7314150366040	1	86,46	116
9Q-1/2	7314150366019	1	102,74	116
9Q-1/4	7314150365999	1	97,72	116
9Q-3/8	7314150366002	1	100,24	116
9R-1/2	7314150365913	1	66,41	115
9R-1/4	7314150365890	1	62,64	115
9R-3/8	7314150365906	1	65,16	115
9T-1/2	7314150366118	1	80,18	116
9T-1/4	7314150366095	1	70,17	116
9T-3/8	7314150366101	1	75,18	116
9W	7314150354399	1	40,46	119
A0313M03	7311518023706	1	14,52	144
A0313M03E	7311518192150	1	17,63	144
A0313M03X	7311518182038	1	15,12	144
A0313M03XE	7311518181475	1	17,65	144
A0313M03XE-60	7311518184513	1	22,62	144
A0313M03XE-80	7311518201357	1	22,97	144
A0314I03	7314150501243	5	13,50	147
A0613M03X	7311518197872	1	26,41	144
A0616AL06E	7311518181802	1	34,68	145
A0616M06	7311518023737	1	25,21	144
A0616M06E	7311518023751	1	28,83	144
A0616M06X	7311518023768	1	27,65	144
A0616M06XE	7311518181468	1	28,83	144
A0618I06	7314150501267	5	20,57	147
A0618S06E	7314150501786	5	20,73	146
A0625M06X	7311518197780	1	32,07	146
A0820M06	7311518023805	1	36,89	144
A0820M06E	7311518023829	1	42,74	144
A0820M06X	7311518023836	1	39,31	144
A0820M06XE	7311518181994	1	45,10	144
A1020I06	7314150501304	5	28,94	147
A1020M06	7311518023874	1	42,34	144
A1020M06E	7311518023898	1	48,79	144
A1020M06X	7311518023904	1	44,35	144
A1020M06XE	7311518182007	1	48,79	144
A1020S06	7314150501335	5	26,53	146
A1020S06E	7314150501793	5	29,18	146
A1225AL06E	7311518187620	1	63,71	145
A1225AL08E	7311518181819	1	63,71	145
A1225I06	7314150506729	5	55,42	147
A1225M06	7311518023942	1	53,04	144
A1225M06E	7311518023966	1	61,08	144
A1225M06X	7311518023973	1	59,14	144
A1225M08	7311518100506	1	55,95	144
A1225M08E	7311518100520	1	61,08	144
A1225M08X	7311518187989	1	56,05	144
A1225M08XE	7311518192174	1	64,32	144
A1225S06	7314150501427	5	41,43	146
A1225S06E	7314150501809	5	45,56	146
A1625AL08XE	7311518244033	1	105,39	145
A1625M06	7311518192181	1	66,52	144
A1625M06X	7311518187361	1	69,95	144
A1625M06XE	7311518187354	1	80,46	144
A1625M08	7311518100568	1	66,52	144
A1625M08E	7311518100582	1	80,45	144
A1625M08X	7311518100599	1	69,95	144
A1625M08XE	7311518182021	1	76,42	144
A6700DM-10	7314151821722	5	5,13	79
A6700DM-11	7314151821739	5	5,13	79
A6700DM-12	7314151821746	5	5,13	79
A6700DM-13	7314151821753	5	5,13	79
A6700DM-14	7314151821760	5	5,13	79
A6700DM-5	7314150220632	5	5,13	79
A6700DM-5.5	7314151821678	5	5,13	79
A6700DM-6	7314151821685	5	5,13	79
A6700DM-7	7314151821692	5	5,13	79
A6700DM-8	7314151821708	5	5,13	79



A6700DM-9	7314151821715	5	5,13	79
A6700DZ-1/2	7314151751883	5	6,58	79
A6700DZ-1/4	7314151751371	5	6,50	79
A6700DZ-11/32	7314151819842	5	6,50	79
A6700DZ-3/16	7314151751029	5	6,50	79
A6700DZ-3/8	7314151751616	5	6,58	79
A6700DZ-5/16	7314151751531	5	6,50	79
A6700DZ-7/16	7314151819859	5	6,58	79
A6700DZ-7/32	7314151751296	5	6,50	79
A6700DZ-9/16	7314151751968	5	6,58	79
A6700DZ-9/32	7314151751456	5	6,50	79
A6709M-2.5	7314151753740	1	31,94	83
A6709M-3	7314151753825	1	31,94	83
A6709M-4	7314151754129	1	31,94	83
A6709M-5	7314151754471	1	31,94	83
A6709M-6	7314151754556	1	31,94	83
A6709MZ/9	7314150512096	1	201,37	68
A6709Z-1/8	7314151755447	1	31,94	83
A6709Z-3/16	7314151755874	1	31,94	83
A6709Z-5/32	7314151755799	1	31,94	83
A6709Z-9/64	7314151755522	1	31,94	83
A6710DM-10	7314151756765	1	41,58	80
A6710DM-11	7314151756840	1	42,25	80
A6710DM-12	7314151756925	1	42,25	80
A6710DM-13	7314151757069	1	42,25	80
A6710DM-14	7314151757144	1	42,25	80
A6710DM-5.5	7314151756178	1	41,58	80
A6710DM-6	7314151756253	1	41,58	80
A6710DM-7	7314151756338	1	41,58	80
A6710DM-8	7314151756413	1	41,58	80
A6710DM-9	7314151756680	1	41,58	80
A6710DZ-1/2	7314151820466	1	42,49	80
A6710DZ-1/4	7314151757229	1	42,25	80
A6710DZ-11/32	7314151757571	1	42,25	80
A6710DZ-3/16	7314151820435	1	42,25	80
A6710DZ-3/8	7314151757656	1	42,25	80
A6710DZ-5/16	7314151757496	1	42,25	80
A6710DZ-7/16	7314151757731	1	42,49	80
A6710DZ-7/32	7314151820442	1	42,25	80
A6710DZ-9/16	7314151820473	1	42,49	80
A6710DZ-9/32	7314151820459	1	42,25	80
A6716DM	7314151820824	1	153,56	65
A6716DZ	7314151820831	1	165,38	67
A6718DZ	7314150312450	1	181,95	68
A6800DM-10	7314151821845	1	12,05	79
A6800DM-11	7314151821852	1	12,05	79
A6800DM-12	7314151821869	1	12,05	79
A6800DM-13	7314151821876	1	12,05	79
A6800DM-14	7314151821883	1	12,05	79
A6800DM-4	7314151821777	1	12,05	79
A6800DM-5	7314151821784	1	12,05	79
A6800DM-5.5	7314151821791	1	12,05	79
A6800DM-6	7314151821807	1	12,05	79
A6800DM-7	7314151821814	1	12,05	79
A6800DM-8	7314151821821	1	12,05	79
A6800DM-9	7314151821838	1	12,05	79
A6800DZ-1/2	7314151758899	1	14,56	80
A6800DZ-1/4	7314151758387	1	14,56	80
A6800DZ-11/32	7314151803872	1	14,56	80
A6800DZ-3/16	7314151758035	1	14,56	80
A6800DZ-3/8	7314151758622	1	14,56	80
A6800DZ-5/16	7314151758547	1	14,56	80
A6800DZ-7/16	7314151803889	1	14,56	80
A6800DZ-7/32	7314151758110	1	14,56	80
A6800DZ-9/16	7314151758974	1	14,56	80
A6800DZ-9/32	7314151758462	1	14,56	80
A6800SM-10	7314150360147	1	11,87	80
A6800SM-11	7314150360154	1	11,87	80
A6800SM-12	7314150360161	1	11,87	80
A6800SM-13	7314150360178	1	11,87	80
A6800SM-14	7314150360185	1	11,87	80
A6800SM-15	7314150360192	1	11,87	80
A6800SM-4	7314150360208	1	11,87	80
A6800SM-4.5	7314150360215	1	11,87	80
A6800SM-5	7314150360222	1	11,87	80
A6800SM-6	7314150360239	1	11,87	80
A6800SM-7	7314150360246	1	11,87	80
A6800SM-8	7314150360253	1	11,87	80
A6800SM-9	7314150360260	1	11,87	80
A6800SZ-1/8	7314150360277	1	15,26	80
A6800SZ-5/32	7314150360284	1	15,26	80
A7400DM-10	7314151819972	5	7,44	85
A7400DM-11	7314151819989	5	7,44	85
A7400DM-12	7314151819996	5	7,44	85
A7400DM-13	7314151820008	5	7,44	85
A7400DM-14	7314151820015	5	7,44	85
A7400DM-15	7314151820022	5	7,55	85
A7400DM-16	7314151820039	5	7,55	85
A7400DM-17	7314151820046	5	7,55	85
A7400DM-18	7314151820053	5	7,55	85
A7400DM-19	7314151820060	5	7,55	85
A7400DM-20	7314151820077	5	7,55	85
A7400DM-21	7314151820084	5	7,64	85
A7400DM-22	7314151820091	5	7,64	85
A7400DM-24	7314150386123	5	8,06	85
A7400DM-6	7314150118212	5	7,44	85



A7400DM-7	7314150118229	5	7,44	85
A7400DM-8	7314150118236	5	7,44	85
A7400DM-9	7314151819965	5	7,44	85
A7400DZ-1/2	7314151759780	5	8,24	86
A7400DZ-1/4	7314151759193	5	8,10	86
A7400DZ-11/16	7314151819897	5	8,36	86
A7400DZ-13/16	7314151819910	5	8,36	86
A7400DZ-17/32	7314151819866	5	8,24	86
A7400DZ-19/32	7314151819873	5	8,24	86
A7400DZ-3/4	7314151819903	5	8,36	86
A7400DZ-3/8	7314151759438	5	8,10	86
A7400DZ-5/16	7314151759278	5	8,10	86
A7400DZ-5/8	7314151819880	5	8,36	86
A7400DZ-7/16	7314151759513	5	8,24	86
A7400DZ-7/8	7314151819927	5	8,36	86
A7400DZ-9/16	7314151759865	5	8,24	86
A7402DM-10	7314151820138	5	14,92	86
A7402DM-11	7314151820145	1	14,92	86
A7402DM-12	7314151820152	1	14,92	86
A7402DM-13	7314151820169	1	14,92	86
A7402DM-14	7314151820176	1	15,61	86
A7402DM-15	7314151820183	1	15,61	86
A7402DM-16	7314151820190	1	15,61	86
A7402DM-17	7314151820206	1	16,64	86
A7402DM-18	7314151820213	1	16,64	86
A7402DM-19	7314151820220	1	16,64	86
A7402DM-21	7314150385881	1	17,02	86
A7402DM-7	7314150220243	1	14,91	86
A7402DM-8	7314150220250	1	14,91	86
A7402DM-9	7314150220267	1	14,92	86
A7402DZ-1/2	7314151760526	1	16,76	86
A7402DZ-1/4	7314151759940	1	16,76	86
A7402DZ-11/16	7314151820114	1	16,76	86
A7402DZ-13/16	7314153003027	1	16,76	86
A7402DZ-19/32	7314153003041	1	16,76	86
A7402DZ-3/4	7314151820121	1	16,76	86
A7402DZ-3/8	7314151760366	1	16,76	86
A7402DZ-5/16	7314151760014	1	16,76	86
A7402DZ-5/8	7314151820107	1	16,76	86
A7402DZ-7/16	7314151760441	1	16,76	86
A7402DZ-7/8	7314153003034	1	16,76	86
A7402DZ-9/16	7314151760793	1	16,76	86
A7410DZ-1/2	7314153006301	1	40,80	86
A7410DZ-11/16	7314153006332	1	45,55	86
A7410DZ-3/4	7314153006349	1	45,55	86
A7410DZ-3/8	7314153006288	1	40,80	86
A7410DZ-5/16	7314153006271	1	39,41	86
A7410DZ-5/8	7314153006325	1	45,55	86
A7410DZ-7/16	7314153006295	1	40,80	86
A7410DZ-9/16	7314153006318	1	40,80	86
A7435DME	7314153015006	1	330,41	70
A7440DME	7314153015419	1	212,59	70
A7535DZE	7314153015013	1	397,56	71
ADJUST 3	7314150103515	1	77,58	39
ADJUST 3-90	7314150236336	1	91,11	38
ADJUST 9031/29	7314150302925	3	63,71	39
AP-234-F	7311518289027	2	92,79	628
AP-3M	7311518152062	1	60,23	626
AP-5M	7311518152079	1	79,55	626
APB260	7314150389162	10	62,12	612
APB360	7314150389186	10	62,77	612
AS-1200	7314150321520	3	65,94	545
AS-C33-JT-F	7314150341672	15	32,91	636
AS-C36-JT-M	7311518337490	15	35,26	636
AS-C39-JT-C	7314150341542	15	35,26	636
AS-C45-JT-C	7314150341559	15	41,13	636
ASP-1850	7311518337124	1	42,17	627
ASP-1850G	7311518337131	1	51,21	627
ASP-AS	7311518337377	6	18,21	627
ASP-AS-C33-JT-F	7314150341665	5	62,08	629
ASP-AS-C36-JT-M	7314150340590	5	64,74	629
ASP-AS-C39-JT-C	7314150341535	5	71,09	629
ASP-AS-C45-JT-C	7314150341566	2	73,63	629
ASP-AS-HOOK	7311518337582	4	39,76	627
ASP-ATP	7311518337384	6	27,71	627
ASP3740-C36JTM	7314150341818	1	202,80	630
ASP3740-C39JTC	7314150353347	1	246,36	630
ASP3740-C45JTC	7314150353354	1	247,18	630
ASP3740-P3437	7314150341801	1	239,67	628
ATP-110-210	7311518337575	1	75,91	626
ATP-200-350	7311518347062	1	96,59	626
ATP-200-500	7311518347055	1	112,51	626
ATP-230-410	7311518337599	2	107,96	627
AUTO	7314150438082	1	4.408,04	375
B141.007.075	7314150278404	5	8,24	206
B141.008.075	7314150278411	5	8,27	206
B141.009.075	7314150278428	5	8,31	206
B141.010.075	7314150278435	5	8,33	206
B141.015.100	7314150278442	5	8,40	206
B141.020.100	7314150278459	5	8,43	206
B141.025.125	7314150278466	5	8,77	206
B141.027.125	7314150278473	5	8,89	206
B141.030.150	7314150278480	5	10,14	206
B141.040.150	7314150278497	5	11,84	206
B142.000.075	7314150278718	10	6,79	496
B142.001.080	7314150278725	10	8,15	496





B142.001.150	7314150343188	10	9,57	496
B142.002.100	7314150278732	10	10,15	496
B142.002.175	7314150343195	10	11,82	496
B142.003.150	7314150278749	10	15,29	496
B143.020.100	7314150278510	5	3,97	206
B143.025.100	7314150278503	10	4,07	206
B143.030.100	7314150278527	10	4,13	206
B143.040.100	7314150278534	10	4,80	206
B143.050.100	7314150278541	10	5,84	206
B143.060.125	7314150278558	10	6,70	206
B143.080.150	7314150278565	5	9,60	206
B144.001.100	7314150278787	5	6,90	206
B144.002.125	7314150278794	5	7,39	206
B144.003.150	7314150278800	5	7,71	206
B145.006.100	7314150278756	5	6,58	207
B146.006.100	7314150278763	5	6,92	207
B147.001.400	7314150285594	1	28,29	371
B147.003.400	7314150285600	1	30,98	371
B148.001.080	7314150314522	10	8,15	496
B148.002.100	7314150314539	10	10,02	496
B149.001.080	7314150314546	10	8,46	496
B149.002.100	7314150314553	10	10,34	496
B150.010.100	7314150343126	10	6,29	496
B150.015.125	7314150343133	10	6,33	496
B150.020.125	7314150343140	10	6,46	496
B150.025.150	7314150343157	10	6,68	496
B190.040.075	7314150277810	10	4,72	204
B190.040.100	7314150277827	10	4,77	204
B190.055.100	7314150277834	10	6,04	204
B190.055.125	7314150277841	10	6,16	204
B190.065.125	7314150277858	10	7,57	204
B190.065.150	7314150277865	10	8,62	204
B190.080.150	7314150277872	10	9,47	204
B190.080.175	7314150277889	10	9,73	204
B190.100.200	7314150277896	10	12,77	204
B190.120.250	7314150277902	10	16,58	204
B190.140.250	7314150277919	10	17,66	204
B191.025.075	7314150277926	10	3,40	204
B191.030.075	7314150277933	10	3,50	204
B191.030.100	7314150277940	10	3,75	204
B191.030.200	7314150277957	10	6,02	204
B191.035.100	7314150277964	10	3,86	204
B191.040.100	7314150277971	10	4,42	204
B191.040.125	7314150277988	10	4,85	204
B191.040.250	7314150277995	10	7,25	204
B191.055.125	7314150278008	10	6,14	204
B191.055.150	7314150278015	10	6,87	204
B191.055.300	7314150278022	10	9,27	204
B191.065.150	7314150278039	10	8,10	204
B191.065.300	7314150278046	10	10,63	204
B192.000.075	7314150278084	10	4,66	205
B192.000.200	7314150278091	10	6,71	205
B192.001.100	7314150278107	10	5,72	205
B192.001.250	7314150278114	10	8,56	205
B192.002.125	7314150278121	10	7,12	205
B192.002.150	7314150442720	10	7,51	205
B192.002.300	7314150278138	10	10,78	205
B192.003.150	7314150278145	10	10,96	205
B192.004.200	7314150278169	10	15,17	205
B193.000.075	7314150278190	10	5,54	205
B193.001.100	7314150278206	10	6,21	205
B193.002.125	7314150278213	10	7,57	205
B193.003.150	7314150278220	10	11,54	205
B193.004.200	7314150278237	10	16,08	205
B194.004.075	7314150278268	10	6,58	206
B194.005.075	7314150278275	10	6,38	206
B194.006.075	7314150278282	10	5,93	206
B194.007.075	7314150278299	10	5,97	206
B194.008.075	7314150278305	10	5,99	206
B194.009.075	7314150278312	10	6,01	206
B194.010.075	7314150278329	10	6,02	206
B194.015.100	7314150278336	10	6,14	206
B194.020.100	7314150278343	10	6,21	206
B194.025.125	7314150278350	10	6,62	206
B194.027.125	7314150278367	10	6,79	206
B194.030.150	7314150278374	10	8,13	206
B194.040.150	7314150278381	10	9,80	206
B194.045.150	7314150278398	5	10,52	206
B195.001.025	7314150278176	10	5,93	205
B195.002.025	7314150278183	10	5,93	205
B195.006.050	7314150289493	5	5,93	207
B195.040.025	7314150278053	10	4,42	204
B195.050.025	7314150278060	10	5,68	204
B195.060.025	7314150278077	10	5,93	204
B195.901.025	7314150278244	10	6,26	205
B195.902.025	7314150278251	10	6,67	205
B196.025.075	7314150278589	10	6,00	495
B196.030.100	7314150278572	10	5,90	495
B196.035.100	7314150278596	10	6,14	495
B196.040.100	7314150278602	10	7,16	495
B196.055.125	7314150278619	10	8,53	495
B196.065.150	7314150278626	10	10,92	495
B196.080.175	7314150278633	10	12,05	495
B196.100.200	7314150278640	10	15,76	495
B196.120.200	7314150278657	10	18,27	495
B197.000.075	7314150278664	10	6,13	496



B197.001.080	7314150278671	10	7,57	496
B197.001.150	7314150343164	10	8,56	496
B197.002.100	7314150278688	10	9,78	496
B197.002.175	7314150343171	10	11,76	496
B197.003.150	7314150278695	10	12,52	496
B197.004.200	7314150278701	10	18,54	496
B198.040.125	7314150278817	5	9,56	207
B198.045.125	7314150278824	5	9,56	207
B198.050.150	7314150278831	5	10,06	207
B198.055.150	7314150281268	5	10,06	207
B198.060.150	7314150281763	5	10,52	207
B198.060.150F	7314150281770	5	15,34	207
B198.070.150	7314150281787	5	11,05	207
B198.070.150F	7314150281794	5	15,86	207
B198.080.150	7314150281800	5	13,30	207
B198.080.150F	7314150281817	5	16,94	207
B198.090.150	7314150281824	5	13,56	207
B198.100.150	7314150281831	5	13,95	207
B198.110.150	7314150281848	5	14,34	207
B198.120.150	7314150281855	5	16,19	207
B198.130.150	7314150281862	5	16,57	207
B198.140.150	7314150281879	5	18,16	207
B199.055.125	7314150281886	5	11,27	496
B199.060.125	7314150281893	5	12,29	496
B199.070.125	7314150281909	5	13,17	496
B199.080.125	7314150281916	5	14,55	496
B199.090.125	7314150281923	5	16,16	496
B199.100.125	7314150281930	5	17,87	496
B199.110.125	7314150281947	5	19,56	496
B199.120.125	7314150287741	5	21,82	496
B199.130.125	7314150287772	5	24,21	496
B219.002	7314150289301	1	10,05	200
B219.004	7314150283248	1	23,31	201
B219.005	7314150283255	1	27,20	201
B219.006	7314150283293	1	31,85	202
B219.007	7314150283323	1	42,59	202
B219.008	7314150283347	1	51,62	203
B219.010	7314150283354	1	54,22	204
B219.012	7314150327768	1	12,67	200
B219.014	7314150533985	1	20,60	200
B219.015	7314150283262	1	26,70	201
B219.016	7314150283309	1	32,53	202
B219.017	7314150283330	1	40,67	202
B219.025	7314150283279	1	30,40	201
B219.026	7314150283316	1	33,73	202
B219.027	7314150399833	1	44,03	203
B219.035	7314150283286	1	37,69	201
B219.045	7314150533992	1	23,69	201
B219.110	7314150392667	1	61,55	203
B219.210	7314150438969	1	60,24	203
B220.002	7314150289295	1	13,19	496
B220.005	7314150283361	1	33,98	497
B220.007	7314150283385	1	50,02	497
B220.012	7314150314614	1	22,07	496
B220.015	7314150283378	1	35,05	497
B220.017	7314150283392	1	52,43	497
B220.027	7314150283408	1	46,32	497
B400.002	8412814119441	1	11,33	608
B400.003	8412814119458	1	11,33	608
B400.004	8412814119465	1	11,33	608
B400.005	8412814119472	1	11,33	608
B400.006	8412814119489	1	11,33	608
B400.007	8412814119496	1	11,33	608
B400.008	8412814119502	1	11,33	609
B400.009	8412814119519	1	11,33	609
B400.010	8412814119526	1	11,33	609
B400.011	8412814119533	1	14,26	609
B400.012	8412814119540	1	14,26	609
B400.013	8412814119557	1	14,26	609
B400.014	8412814119564	1	14,26	609
B400.015	8412814119571	1	14,26	609
B400.016	8412814119588	1	14,26	609
B400.017	8412814119595	1	14,26	609
B400.018	8412814119601	1	14,26	609
B400.019	8412814119618	1	14,26	609
B400.020	8412814119625	1	14,26	609
B400.021	8412814119632	1	18,90	609
B400.022	8412814119649	1	18,90	609
B400.023	8412814119656	1	18,90	609
B400.024	8412814119663	1	18,90	609
B400.025	8412814119670	1	18,90	609
B400.026	8412814119687	1	18,90	609
B400.027	8412814119694	1	18,90	609
B400.028	8412814119700	1	18,90	609
B400.029	8412814119717	1	18,90	609
B400.030	8412814119724	1	18,90	609
B400.031	8412814119731	1	24,41	609
B400.032	8412814119748	1	24,41	609
B400.033	8412814119755	1	24,41	609
B400.034	8412814119762	1	24,41	609
B400.035	8412814119779	1	24,41	609
B400.036	8412814119786	1	24,41	609
B400.037	8412814119793	1	24,41	609
B400.038	8412814119800	1	24,41	609
B400.039	8412814119817	1	24,41	609
B400.040	8412814119823	1	24,41	609



B400.041	8412814119830	1	28,71	609
B400.042	8412814119847	1	28,71	609
B400.043	8412814119854	1	28,71	609
B400.044	8412814119861	1	28,71	609
B400.045	8412814119878	1	28,71	609
B400.046	8412814119885	1	28,71	609
B400.047	8412814119892	1	28,71	609
B400.048	8412814119908	1	28,71	609
B400.049	8412814119915	1	28,71	609
B400.050	8412814119922	1	28,71	609
B705.1/4.125	7314150281978	5	12,00	216
BAC007	7314150242337	1	12,12	313
BASIC	7314150437436	1	1.464,04	375
BB10	7314150240586	1	12,18	338
BBA1224-3200	7314150341955	1	3.336,29	337
BBAGM12-1200	7314150535675	1	556,20	337
BBAGM1224-2400	7314150535682	1	1.261,75	337
BBAGMBAT	7314150537709	1	380,07	337
BBAGMCAB	7314150537723	1	20,09	337
BBAGMCHG	7314150537747	1	96,82	337
BBBCAB-AUZ	7314150183944	1	11,82	341
BBBCAB-EU	7314150186648	1	14,01	341
BBBCAB-UK	7314150183937	1	11,82	341
BBC420	7314150243235	1	583,69	338
BBC620	7314150243242	1	835,73	338
BBCE12-10	7314150330263	2	145,92	338
BBCE12-15S	7314150406722	2	177,30	338
BBCE12-3	7314150330249	2	99,50	338
BBCE12-6	7314150330256	2	119,39	338
BBCE12-F100	7314150344710	1	1.406,14	338
BBCE24-10	7314150330287	2	198,99	338
BBCEC1	7314150335459	1	9,82	340
BBCEC2	7314150337460	1	13,21	341
BB CER1	7314150335466	1	9,95	340
BB CER2	7314150337484	1	13,21	341
BBH12-1200	7314150360734	1	908,96	337
BBJL1630	7314150244898	5	41,13	338
BBJL2535	7314150209453	1	95,52	338
BBJL3545	7314150209460	1	127,09	338
BBR100	7314150345922	1	47,13	324
BBR110	7314150170562	1	100,99	325
BBR1501	7314150439119	24	17,29	328
BBR201P6	7314150205752	8	81,19	327
BBR201P64014	7314150237852	1	8,32	327
BBR201P64016	7314150237753	1	8,32	327
BBR201P64018	7314150237760	1	8,55	327
BBR201P67814	7314150237777	1	9,58	327
BBR201P67816	7314150237784	1	9,58	327
BBR201P67818	7314150237791	1	10,47	327
BBR202P4	7314150205769	1	45,76	327
BBR202P410	7314150207688	1	6,80	327
BBR202P414	7314150207695	1	6,80	327
BBR202P419	7314150207701	1	8,32	327
BBR202P455	7314150231393	1	8,32	327
BBR203P9	7314150208081	1	116,63	327
BBR203P920	7314150231102	1	15,47	327
BBR203P925	7314150231119	1	15,47	327
BBR203P927	7314150231126	1	15,47	327
BBR203P930	7314150231133	1	15,47	327
BBR203P940	7314150231140	1	15,47	327
BBR203P945	7314150231157	1	15,47	327
BBR203P950	7314150231164	1	15,47	327
BBR203P955	7314150231171	1	16,38	327
BBR203P960	7314150231188	1	16,38	327
BBR204	7314150430635	6	34,84	328
BBR210P3	7314150206056	1	155,02	327
BBR300P50	7314150269624	4	263,90	327
BBR320	7314150169887	1	100,31	326
BBR350	7314150169900	1	200,63	325
BBR400	7314150345939	1	37,70	326
BBR405	7314150435807	20	197,78	326
BBR410	7314150345946	24	51,15	326
BBR420	7314150403394	50	85,42	326
BBR501011	7314150438143	50	72,04	325
BBR50121314	7314150438150	50	72,04	325
BBR6131	7314150239443	1	32,88	328
BBR6135	7314150239450	1	65,98	327
BBRAS14	7314150416943	4	291,19	325
BBRAS14-01	7314150418060	1	53,95	325
BBRAS14-02	7314150418077	1	26,00	325
BBRAS14-03	7314150418084	1	23,12	325
BBRAS14-04	7314150418091	1	34,65	325
BBRAS14-05	7314150418107	1	7,71	325
BBRAS14-06	7314150418114	1	8,67	325
BBRAS14-07	7314150418121	1	12,53	325
BBRAS14-08	7314150418138	1	14,24	325
BBRAS14-09	7314150418145	1	14,81	325
BBRAS14-10	7314150418152	1	12,07	325
BBRAS14-11	7314150418169	1	65,93	325
BBRAS14-12	7314150418176	1	9,52	325
BBRAS14-13	7314150418183	1	21,60	325
BBRAS14-14	7314150418190	1	10,59	325
BBRBB12	7314150371297	1	1.714,82	325
BBRFKM1	7314150384938	12	187,66	328
BBRPTG1	7314150412617	10	20,58	325
BBRS210P	7314150206070	1	99,37	327



BBRS210P2	7314150206063	1	113,58	327
BBS075	7314150249824	12	40,52	344
BBS100	7314150169870	1	75,40	348
BBS10001	7314150207183	1	7,55	348
BBS10002	7314150207190	1	13,33	348
BBS10003	7314150207206	1	9,07	348
BBS10004	7314150207213	1	20,84	348
BBS10005	7314150207220	1	5,01	348
BBS100057	7314150186655	1	2,18	348
BBS10006	7314150207237	1	3,48	348
BBS10007	7314150207244	1	3,35	348
BBS10008	7314150207251	1	3,48	348
BBS10009	7314150207268	1	3,35	348
BBS10010	7314150207275	1	3,35	348
BBS101	7314150243525	1	30,97	345
BBS102	7314150243518	1	12,38	345
BBS103	7314150243488	1	20,20	345
BBS10450	7314150243501	1	28,01	345
BBS105	7314150250868	1	40,39	345
BBS106	7314150243495	1	19,73	345
BBS107	7314150250875	1	10,72	345
BBS108	7314150250882	1	10,72	345
BBS12SH	7314150243563	1	435,81	346
BBS150	7314150169849	1	129,26	344
BBS150R	7314150244959	1	49,82	345
BBS150S	7314150244973	1	57,90	345
BBS150T	7314150244966	1	63,29	345
BBS165	7314150205615	10	114,46	345
BBS165SP4	7314150205622	50	16,99	346
BBS170P13	7314150205608	1	212,74	346
BBS170P131	7314150231843	1	10,97	346
BBS170P132	7314150231850	1	10,97	346
BBS170P133	7314150231867	1	10,97	346
BBS170P134	7314150231874	1	10,97	346
BBS170P135	7314150231881	1	10,97	346
BBS170P136	7314150231898	1	10,97	346
BBS170P137	7314150231904	1	10,97	346
BBS170P138	7314150231911	1	12,72	346
BBS170P139	7314150231928	1	13,56	346
BBS200	7314150239498	1	43,09	348
BBS200P12	7314150169856	1	61,94	348
BBS210	7314150215362	1	399,91	348
BBS210U06	7314150217656	1	24,01	348
BBS210U08	7314150217663	1	26,15	348
BBS210UA06	7314150217670	1	29,09	348
BBS210UA08	7314150217687	1	32,02	348
BBS210V06	7314150217632	1	24,01	348
BBS210V08	7314150217649	1	26,15	348
BBS210W06	7314150218738	1	31,30	348
BBS210W08	7314150218745	1	34,18	348
BBS3BH1	7314150356843	1	114,46	344
BBS3BH1-VP	7314150355501	40	16,18	344
BBS3UH	7314150242351	1	462,55	344
BBS50	7314150169863	1	55,06	343
BBSDA	7314150247127	1	58,16	347
BBSDC	7314150247158	6	60,42	347
BBSDD	7314150247165	1	45,76	347
BBSDH	7314150247141	1	54,03	347
BBSDHR	7314150249299	1	24,13	347
BBSDT	7314150247134	6	65,73	347
BBSDW	7314150247110	6	45,23	347
BBSHF	7314150247189	1	43,57	346
BBSHM1	7314150247196	1	61,20	346
BBSH2C	7314150247202	1	44,44	346
BBSH2CA	7314150247219	12	49,82	346
BBSH2CP	7314150247226	6	45,13	346
BBSH2F	7314150247172	6	44,44	346
BBSH3CF	7314150247240	6	45,46	346
BBSH3CF30	7314150247264	6	48,35	346
BBSH3FS	7314150247257	6	48,44	346
BBSH3MF	7314150247233	1	47,18	347
BBSHWH1	7314150328932	1	15,48	347
BBSS1	7314150247288	1	103,77	347
BBSS2	7314150247271	8	112,94	347
BBSS2L	7314150247295	1	118,14	347
BBT20	7314150166961	1	98,17	339
BBT60A	7314150504169	36	215,22	339
BBT80	7314150327805	6	608,90	339
BCL31B1	7314150389704	1	56,59	293
BCL31C1	7314150389742	1	83,75	293
BCL31D1	7314150389582	1	167,50	291
BCL31D1K1	7314150400843	1	307,72	291
BCL31IS1	7314150389599	1	192,25	291
BCL31IS1K1	7314150400836	1	332,46	291
BCL31IW1	7314150389551	1	192,25	290
BCL31IW1K1	7314150400829	1	332,46	290
BCL31R1	7314150389568	1	241,41	290
BCL31R1K1	7314150400850	1	381,82	291
BCL31SD1	7314150389575	1	167,50	291
BCL31SD1K1	7314150402656	1	307,85	291
BCL32B1	7314150389711	1	76,39	293
BCL32DG1	7314150389605	1	197,07	292
BCL32DG1K1	7314150402670	1	370,78	292
BCL32G1	7314150389629	1	320,16	293
BCL32G1K1	7314150400911	1	480,29	292
BCL32IW1	7314150389643	1	339,95	290



BCL32IW1K1



BCL32IW1K1	7314150402663	1	490,12	290
BCL32RS1	7314150389636	1	307,85	292
BCL32RS1K1	7314150400904	1	467,99	292
BCL32SP1	7314150389612	1	251,25	292
BCL32SP1K1	7314150400898	1	418,76	292
BCL33AP1	7314150389650	1	332,46	292
BCL33AP1K1	7314150402687	1	615,75	292
BCL33B1	7314150389728	1	110,91	293
BCL33B3	7314150389735	1	169,91	293
BCL33C1	7314150389759	1	96,06	293
BCL33C2	7314150389766	1	120,80	293
BCL33D1	7314150389681	1	270,92	291
BCL33D1K1	7314150400881	1	490,45	291
BCL33IW1	7314150389667	1	394,01	290
BCL33IW1K1	7314150400867	10	677,37	290
BCL33IW2	7314150389674	1	554,21	290
BCL33IW2K1	7314150400874	1	825,13	290
BDACM1000	7314150500819	30	124,65	339
BE-3529	7314151847845	5	18,90	536
BE-6400M-4	7314153011145	5	12,21	194
BE-6400M-5	7314153011169	5	12,89	194
BE-6400M-5.5	7314153011176	5	12,89	194
BE-6400M-7	7314153011190	5	14,15	194
BE-6902	7314150242641	5	4,18	193
BE-6903	7314150242665	5	4,72	193
BE-6925	7314150242658	5	4,25	193
BE-6990-IP10	7314151846763	1	59,83	112
BE-6990-IP10-KL	7314151847531	10	7,51	113
BE-6990-IP15	7314151846770	1	59,83	112
BE-6990-IP15-KL	7314151847548	10	7,51	113
BE-6990-IP20-KL	7314151848668	10	6,05	113
BE-6990-IP6	7314151846725	1	59,83	112
BE-6990-IP6-KL	7314151847494	10	7,51	113
BE-6990-IP7	7314151846732	1	59,83	112
BE-6990-IP7-KL	7314151847500	10	7,51	113
BE-6990-IP8	7314151846749	1	59,83	112
BE-6990-IP8-KL	7314151847517	10	7,51	113
BE-6990-IP9	7314151846756	1	59,83	112
BE-6990-IP9-KL	7314151847524	10	7,51	113
BE-6990-IPSET	7314153019356	1	206,04	113
BE-6990TX-T10KL	7314151847760	10	7,46	113
BE-6990TX-T15KL	7314151847777	10	7,46	113
BE-6990TX-T20KL	7314151848682	10	7,46	113
BE-6990TX-T6-KL	7314151847722	10	7,46	113
BE-6990TX-T7-KL	7314151847739	10	7,46	113
BE-6990TX-T8-KL	7314151847746	10	7,46	113
BE-6990TX-T9-KL	7314151847753	10	7,46	113
BE-7515	7314150242528	5	8,24	192
BE-7520	7314150242535	5	8,43	192
BE-7525	7314150242542	5	8,91	192
BE-7527	7314150242559	5	9,68	192
BE-7530	7314150242566	5	10,39	192
BE-7540	7314150242573	5	11,53	192
BE-7606	7314151839017	5	20,02	195
BE-7607	7314151839024	5	20,30	195
BE-7608	7314151839031	5	21,67	195
BE-7675	7314150123896	1	62,41	228
BE-7715	7314150242580	5	10,30	192
BE-7720	7314150242597	5	10,37	192
BE-7725	7314150242603	5	10,70	192
BE-7727	7314150242610	5	10,83	192
BE-7730	7314150242627	5	11,23	192
BE-7740	7314150242634	5	11,49	192
BE-7803	7314151838867	5	12,21	194
BE-7804	7314151838881	5	12,21	194
BE-7805	7314151838904	5	12,89	194
BE-7806	7314151838928	5	13,49	194
BE-7806S	7314150242986	5	15,97	492
BE-7807	7314151838935	5	14,15	194
BE-7807S	7314150242993	5	17,12	492
BE-7808	7314151838942	5	17,03	194
BE-7808S	7314150243006	5	18,90	492
BE-7809	7314151838959	5	17,36	194
BE-7809S	7314150243013	5	21,02	492
BE-7810	7314151838966	5	17,86	194
BE-7810S	7314150243020	5	23,25	492
BE-7811	7314151838973	5	18,37	194
BE-7812	7314151838980	5	20,73	194
BE-7813	7314151838997	5	21,41	194
BE-7814	7314151839000	5	23,27	194
BE-7835	7314151838874	5	12,21	194
BE-7845	7314151838898	5	12,21	194
BE-7855	7314151838911	5	12,89	194
BE-7855S	7314150242979	5	14,54	492
BE-7907	7314153010964	5	10,55	192
BE-7908	7314153010971	5	10,59	192
BE-7909	7314153010988	5	10,62	192
BE-7910	7314151838799	5	10,66	192
BE-7915	7314151838805	5	10,73	192
BE-7920	7314151838812	5	10,79	192
BE-7925	7314151838829	5	11,23	192
BE-7927	7314151838836	5	11,40	192
BE-7930	7314151838843	5	12,98	192
BE-7940	7314151838850	5	15,17	192
BE-8002	7314150242825	5	3,91	190
BE-8010	7314150010615	5	4,04	190



BE-8010S	7314150033058	5	7,65	492
BE-8020	7314150010639	5	5,74	190
BE-8020I	7314150270316	5	6,69	528
BE-8020L	7314151838591	5	4,47	190
BE-8022	7314150242474	5	4,81	190
BE-8030	7314150010653	5	4,94	190
BE-8030I	7314150270330	5	7,21	528
BE-8040	7314150010677	5	5,65	190
BE-8040I	7314150270347	5	8,26	528
BE-8040S	7314150033089	5	9,28	492
BE-8040SL	7314150304578	10	10,21	494
BE-8050S	7314150033096	5	11,08	492
BE-8050SL	7314150304592	10	12,19	494
BE-8065S	7314150033119	5	15,65	492
BE-8080-1	7314153010995	5	15,20	193
BE-8080-10	7314153011060	5	21,63	193
BE-8080-2	7314153011008	5	15,66	193
BE-8080-3	7314153011015	5	15,66	193
BE-8080-4	7314153011022	5	15,66	193
BE-8080-5	7314153011039	5	15,66	193
BE-8080-6	7314153011046	5	15,66	193
BE-8080-8	7314153011053	5	21,63	193
BE-8135TB	7314150275052	10	8,52	199
BE-8145TB	7314150275076	10	11,22	199
BE-8150	7314150010707	5	7,74	190
BE-8150TB	7314150275113	10	12,98	199
BE-8155	7314150010721	5	9,71	190
BE-8155TB	7314150275090	5	15,25	199
BE-8158	7314153010858	5	12,54	190
BE-8159	7314153010865	5	14,75	190
BE-8160	7314150010745	5	14,39	190
BE-8210	7314151838584	5	4,34	190
BE-8220	7314150047741	5	6,52	190
BE-8220S	7314150048243	5	7,65	492
BE-8220SL	7314150304530	10	8,43	494
BE-8225	7314150242443	5	7,70	190
BE-8230	7314150047758	5	6,21	190
BE-8230S	7314150048250	5	7,98	492
BE-8230SL	7314150304554	10	8,78	494
BE-8235	7314150242450	5	7,93	190
BE-8240	7314150047765	5	9,28	190
BE-8241	7314150242467	5	7,86	190
BE-8241I	7314150270866	5	10,50	528
BE-8242	7314153010803	5	8,79	190
BE-8250	7314150047772	5	10,63	190
BE-8250L	7314151838607	5	11,88	190
BE-8251	7314150242481	5	9,60	190
BE-8252	7314153010810	5	10,37	190
BE-8252I	7314150270361	5	14,61	528
BE-8255	7314150047789	5	11,03	190
BE-8255S	7314150048281	5	14,17	492
BE-8255SL	7314150304615	10	15,60	494
BE-8256	7314153010827	5	12,12	190
BE-8256TB	7314150275137	10	20,19	199
BE-8257	7314153010834	5	12,45	190
BE-8258	7314153010841	5	16,36	190
BE-8258S	7314150242818	5	20,46	492
BE-8258TB	7314150275151	10	24,34	199
BE-8259S	7314150242832	5	23,78	492
BE-8260	7314150047796	5	16,72	190
BE-8262TB	7314150275526	10	29,23	199
BE-8330	7314151838614	5	5,29	190
BE-8340	7314151838621	5	5,65	190
BE-8350	7314151838638	5	7,25	190
BE-8355	7314151838652	5	7,58	191
BE-8360	7314151838676	5	8,70	191
BE-8450	7314151838645	5	7,83	190
BE-8455	7314151838669	5	9,07	191
BE-8510S	7314150126507	5	9,80	492
BE-8510SL	7314150304813	10	10,78	494
BE-8520S	7314150126514	5	13,35	492
BE-8520SL	7314150304837	10	14,69	494
BE-8571	7314150244652	1	63,59	197
BE-8572	7314150244669	1	67,44	197
BE-8573	7314150244676	1	65,53	198
BE-8574	7314150258666	1	66,09	198
BE-8575	7314150244638	1	19,92	195
BE-8576	7314150245741	1	130,47	198
BE-8577	7314151839048	5	15,34	195
BE-8600	7314150010769	5	5,97	191
BE-8600I	7314150270378	5	8,10	528
BE-8600S	7314150033126	5	7,97	492
BE-8601	7314151838706	5	7,84	191
BE-8602	7314151838713	5	7,84	191
BE-8605	7314150242498	5	6,13	191
BE-8608	7314150242504	5	8,60	191
BE-8610	7314150010776	5	7,33	191
BE-8610I	7314150270392	5	10,03	528
BE-8610L	7314151838683	5	10,97	191
BE-8610S	7314150033133	5	9,86	492
BE-8610SL	7314150304639	10	10,84	494
BE-8610TB	7314150275199	10	13,83	199
BE-8611	7311518292317	5	7,24	191
BE-8611S	7314150414703	5	9,84	492
BE-8612S	7314150242856	5	11,24	492
BE-8620	7314150010783	5	8,19	191

			€	
BE-8620I	7314150270408	5	14,07	528
BE-8620L	7314151838690	5	13,80	191
BE-8620S	7314150033140	5	12,70	492
BE-8620SL	7314150304653	10	13,99	494
BE-8620TB	7314150275212	10	15,35	199
BE-8621	7311518292324	5	8,04	191
BE-8621S	7314150242863	5	15,41	492
BE-8622	7314150242511	5	9,14	191
BE-8622S	7314150242870	5	15,45	492
BE-8623	7314153010872	5	14,03	191
BE-8623I	7314150270415	5	21,27	528
BE-8623TB	7314150275236	10	20,46	199
BE-8624	7314153010889	5	19,43	191
BE-8624TB	7314150275250	10	29,78	199
BE-8628	7314153010896	5	9,73	191
BE-8629	7314153010902	5	12,35	191
BE-8630	7314150010790	5	16,91	191
BE-8630S	7314150033157	5	16,29	492
BE-8640	7314150010806	5	22,52	191
BE-8640S	7314150033164	5	24,11	492
BE-8675	7314150123872	1	75,09	228
BE-8700-1/4	7314150242689	5	10,06	193
BE-8700-3/16	7314150242696	5	7,98	193
BE-8700-3/8	7314150242702	5	18,16	193
BE-8700-5/16	7314150242719	5	14,20	193
BE-8700-5/32	7314150242726	5	6,23	193
BE-8700-7/32	7314150242733	5	8,58	193
BE-8700-7/64	7314150275878	5	8,87	193
BE-8702	7314151838768	5	5,11	193
BE-8703	7314150027651	5	5,29	193
BE-8703S	7314151839130	5	6,57	492
BE-8704	7314150027668	5	6,02	193
BE-8704S	7314151839147	5	7,99	492
BE-8705	7314150027675	5	7,47	193
BE-8705S	7314151839154	5	9,04	492
BE-8706	7314150027682	5	8,58	193
BE-8706S	7314151839161	5	9,51	492
BE-8708	7314150027699	5	12,28	193
BE-8708S	7314151839178	5	12,80	492
BE-8710	7314150027705	5	13,86	193
BE-8710S	7314150126521	5	10,67	492
BE-8710SL	7314150304851	10	11,74	494
BE-8715	7314150242672	5	4,93	193
BE-8720S	7314150126538	5	14,43	492
BE-8720SL	7314150304875	10	15,88	494
BE-8725	7314151838775	5	5,22	193
BE-8725S	7314151839123	5	6,30	492
BE-8800	7314150042012	5	7,12	191
BE-8800I	7314150270422	5	10,00	528
BE-8800S	7314151839055	5	8,85	492
BE-8801	7314151838744	5	8,03	192
BE-8802	7314151838751	5	8,03	192
BE-8810	7314150010813	5	7,96	191
BE-8810I	7314150270439	5	11,59	528
BE-8810L	7314151838720	5	9,26	191
BE-8810S	7314150048298	5	10,58	492
BE-8810SL	7314150304677	10	11,65	494
BE-8810TB	7314150275274	10	12,40	199
BE-8811	7311518292331	5	7,24	191
BE-8811S	7314150414710	5	10,58	492
BE-8812S	7314150242894	5	12,53	492
BE-8820	7314150010820	5	9,71	191
BE-8820I	7314150270446	5	15,29	528
BE-8820L	7314151838737	5	19,76	191
BE-8820S	7314150048304	5	13,20	492
BE-8820SL	7314150304691	10	14,51	494
BE-8820TB	7314150275298	10	17,56	199
BE-8821	7311518292348	5	16,37	191
BE-8821S	7314150242900	5	13,69	492
BE-8822S	7314150242917	5	15,50	492
BE-8823	7314153010919	5	14,77	191
BE-8823I	7314150270453	5	22,35	528
BE-8823TB	7314150275311	10	22,99	199
BE-8824	7314153010926	5	20,60	191
BE-8824TB	7314150275335	10	32,05	199
BE-8828	7314153010933	5	11,93	191
BE-8829	7314153010940	5	15,34	191
BE-8830	7314150010837	5	14,81	191
BE-8830S	7314150048311	5	19,87	492
BE-8840	7314150010844	5	19,38	191
BE-8840S	7314151839062	5	22,81	492
BE-8865	7314150010851	5	17,09	190
BE-8870	7314150010875	5	18,40	190
BE-8880	7314150010899	5	23,49	190
BE-8890	7314150010905	5	29,70	190
BE-8904	7314153010957	5	7,51	192
BE-8905	7314153010049	5	7,51	192
BE-8905S	7314150242924	5	8,00	492
BE-8906	7314150027729	5	7,58	192
BE-8906S	7314150242931	5	8,00	492
BE-8907	7314150027736	5	7,63	192
BE-8907S	7314150242948	5	8,00	492
BE-8908	7314150027743	5	7,66	192
BE-8908S	7314150242955	5	8,00	492
BE-8909	7314150027750	5	7,69	192
BE-8909S	7314150242962	5	8,00	492

			€	
BE-8910	7314150027767	5	7,70	192
BE-8910I	7314150270460	5	9,79	528
BE-8910S	7314151839079	5	8,26	492
BE-8910SL	7314150304714	5	9,08	494
BE-8910TB	7314150275359	5	8,03	200
BE-8915	7314150027774	5	7,86	192
BE-8915I	7314150270477	5	9,87	528
BE-8915S	7314151839086	5	8,32	492
BE-8915SL	7314150304738	5	9,16	494
BE-8915TB	7314150275373	5	10,89	200
BE-8920	7314150027781	5	7,96	192
BE-8920I	7314150270484	5	10,00	528
BE-8920S	7314151839093	5	8,47	492
BE-8920SL	7314150304752	5	9,32	494
BE-8920TB	7314150275397	5	11,08	200
BE-8925	7314150027798	5	8,49	192
BE-8925I	7314150270491	5	10,67	528
BE-8925S	7314151839109	5	8,78	492
BE-8925SL	7314150304776	5	9,66	494
BE-8925TB	7314150275410	5	11,78	200
BE-8927	7314150027804	5	8,71	192
BE-8927TB	7314150275434	5	12,88	200
BE-8930	7314150027811	5	10,41	192
BE-8930S	7314151839116	5	11,34	492
BE-8930SL	7314150304790	5	12,49	494
BE-8930TB	7314150275458	5	13,53	200
BE-8940	7314150027828	5	12,55	192
BE-8940TB	7314150275472	5	15,28	200
BE-8945	7314151838782	5	13,49	192
BE-8975	7314150056576	6	41,81	227
BE-8975B	7314150188741	6	41,81	227
BE-8976B	7314150216369	6	47,49	228
BE-8980	7314153010681	5	8,87	194
BE-8985	7314153010698	5	8,43	194
BE-8986	7314150267026	5	8,77	194
BE-9001	7311518269005	5	8,82	193
BE-9002	7311518269012	5	9,48	193
BE-9003	7311518269029	5	9,87	193
BE-9100	7314150242757	5	9,35	193
BE-9101	7314150242764	5	9,35	193
BE-9102	7314150242771	5	9,35	193
BE-9103	7314150242788	5	9,35	193
BE-9104	7314150242795	5	10,73	193
BE-9105	7314150242801	5	10,73	193
BE-9575	7314150123841	1	46,06	227
BE-9578	7314150123803	1	13,04	224
BE-9585	7314150123858	1	48,85	227
BE-9586	7314150216000	1	10,06	224
BE-9588	7314150123810	1	20,67	225
BE-9675	7314150123889	1	67,02	227
BE-9676	7314150216017	1	17,43	225
BE-9678	7314150123827	1	32,28	225
BE-9688	7314150123834	1	34,47	225
BE-9765	7314150055128	3	10,75	225
BE-9770	7314150027712	3	17,72	225
BE-9770I	7314150276332	20	33,68	528
BE-9775	7314150056330	3	15,89	226
BE-9776	7314150056545	6	18,06	224
BE-9776B	7314150216352	6	34,92	225
BE-9777	7314150056552	6	24,49	224
BE-9777B	7314150188734	6	23,49	224
BE-9780	7314150033386	3	29,29	226
BE-9785	7314150056347	3	27,13	226
BE-9786I	7314150314485	1	41,86	529
BE-9787	7314150056569	6	25,91	224
BE-9871	7314150234707	1	45,01	189
BE-9871SL	7314150470792	1	53,62	495
BE-9872	7314150440412	1	74,76	189
BE-9872SL	7314150470785	1	54,77	495
BE-9875	7314150314447	1	100,25	189
BE-9876S	7314150315000	1	113,74	494
BE-9877	7314150320745	1	108,65	190
BE-9878	7314150186259	1	14,44	222
BE-9878SL	7314150321018	1	107,89	495
BE-9879	7314150383474	1	80,98	189
BE-9880	7314150238569	3	38,37	223
BE-9880SL	7314150337651	1	42,85	495
BE-9881	7314150043279	1	42,41	188
BE-9881I	7314150270507	1	57,20	528
BE-9881S	7314151839307	1	44,18	493
BE-9881SL	7314150304899	1	48,59	495
BE-9881TB	7314150275502	1	56,70	198
BE-9882	7314151839284	1	44,13	188
BE-9882I	7314150270514	1	59,69	528
BE-9882S	7314151839314	1	45,58	493
BE-9882SL	7314150304912	1	50,14	495
BE-9882TB	7314150275496	1	59,39	199
BE-9884	7314150243068	1	45,99	188
BE-9884S	7314150236602	1	64,77	493
BE-9885	7314150048465	1	40,50	188
BE-9885S	7314150126491	1	47,06	493
BE-9885TB	7314150275519	1	52,23	199
BE-9886	7314150048472	1	44,94	188
BE-9887S	7314150244744	1	60,22	493
BE-9888S	7314153006158	1	65,00	493
BE-9889S	7314150244751	1	55,37	493





BE-9890S	7314150237715	1	24,13	493
BE-9890SL	7314150315086	1	26,56	494
BE-9891SL	7314150321506	1	23,87	494
BE-9894SL	7314150321490	1	25,16	495
BE1100	7314150205929	8	324,81	309
BE110001	7314150230228	1	60,93	309
BE110014	7314150230204	1	20,92	308
BE110015	7314150230211	1	102,28	308
BE1100AC1	7314150230266	1	68,12	308
BE1100AC2	7314150333394	1	21,21	308
BE1200P6	7314150205516	1	152,72	306
BE1200P6AC1	7314150205523	1	108,56	306
BE1205	7314150205554	1	80,79	306
BE1210P11	7314150209101	1	157,54	307
BE1210P1101	7314150269822	1	12,58	306
BE1210P1102	7314150269839	1	13,57	306
BE1210P1103	7314150269846	1	13,57	306
BE1210P9AC1	7314150205547	1	107,75	307
BE1300	7314150205578	1	95,60	305
BE1300SH	7314150205585	10	49,82	305
BE1305P450	7314150206032	1	333,91	305
BE1305P450WS01	7314150269228	1	24,55	305
BE1305P450WS02	7314150269235	1	13,24	305
BE1305P450WS03	7314150269242	1	20,92	305
BE1305P450WS04	7314150269327	1	25,05	305
BE1305P450WS05	7314150269334	1	28,63	305
BE1305P450WS06	7314150269341	1	32,75	305
BE1305P450WS07	7314150269358	1	20,33	305
BE1305P450WS08	7314150269365	1	21,53	305
BE1305P450WS09	7314150269372	1	26,25	305
BE1305P450WS10	7314150269310	1	28,63	305
BE1305P450WS11	7314150269389	1	29,16	305
BE1305P450WS12	7314150269396	1	17,41	305
BE1305P450WS13	7314150269402	1	13,24	305
BE1305P450WS14	7314150269419	1	13,24	305
BE1305P450WS15	7314150269426	1	29,16	305
BE1310P4	7314150205707	1	114,46	304
BE1310P425	7314150233649	1	27,49	304
BE1310P427	7314150233656	1	30,09	304
BE1310P429	7314150233663	1	32,47	304
BE1310P430	7314150233670	1	32,47	304
BE1311P13	7314150235414	1	422,79	304
BE1312DNS	7314150450596	12	11,44	305
BE1315P7	7314150205776	1	121,04	305
BE1315P71	7314150230273	1	23,45	305
BE1315P72	7314150230280	1	19,67	305
BE1315P73	7314150230297	1	24,36	305
BE1315P74	7314150230303	1	23,81	305
BE1315P75	7314150230310	1	23,81	305
BE1315P76	7314150230327	1	24,36	305
BE1315P77	7314150230334	1	26,88	305
BE1320S17	7314150415366	10	118,63	304
BE13ZL11	7314150239733	1	605,90	306
BE1FFWF	7314150403325	12	23,56	315
BE1FLD1	7314150250745	1	16,30	315
BE1FLD2	7314150250752	1	16,30	315
BE1FLD3	7314150250769	1	16,30	315
BE1FLDS	7314150250783	1	44,44	315
BE1FTW	7314150251209	1	67,86	315
BE1GP5	7314150170043	1	65,01	306
BE1GP5-T	7314150170050	10	29,17	306
BE1GP510	7314150207732	1	22,52	307
BE1GP512	7314150207749	1	22,52	307
BE1GP514	7314150207756	1	22,52	307
BE1GP58	7314150207718	1	22,52	307
BE1GP59	7314150207725	1	22,52	307
BE1P	7314150170067	1	76,05	307
BE1SP14L	7314150170074	1	26,80	307
BE1SP16L	7314150492756	10	26,80	307
BE1SP1F	7314150435777	12	28,52	307
BE1T14	7314150167630	1	34,74	307
BE1T16	7314150167647	1	39,72	307
BE1T21	7314150167654	1	39,14	307
BE1TH-10	7314150343980	5	29,95	316
BE1TH-12	7314150343997	5	36,37	316
BE1TH-2	7314150343874	10	17,23	316
BE1TH-2.5	7314150343881	10	17,23	316
BE1TH-3	7314150343898	10	17,70	316
BE1TH-3.5	7314150343904	10	17,70	316
BE1TH-4	7314150343911	10	20,13	316
BE1TH-4.5	7314150343928	10	20,86	316
BE1TH-5	7314150343935	10	21,54	316
BE1TH-6	7314150343942	10	23,84	316
BE1TH-7	7314150343959	10	27,42	316
BE1TH-8	7314150343966	10	27,42	316
BE1TH-9	7314150343973	10	29,95	316
BE1TH-S5	7314150457502	1	88,76	315
BE1TH-S6	7314150344017	30	99,64	315
BE1TS-10	7314150344062	10	29,62	316
BE1TS-11	7314150344079	10	29,88	316
BE1TS-12	7314150344086	10	30,69	316
BE1TS-13	7314150344093	10	31,37	316
BE1TS-14	7314150344109	10	31,37	316
BE1TS-15	7314150344116	10	34,00	316
BE1TS-16	7314150344123	10	34,00	316
BE1TS-17	7314150344130	10	34,00	316



BE1TS-18	7314150344147	10	37,16	316
BE1TS-19	7314150344154	10	37,16	316
BE1TS-20	7314150344161	8	43,90	316
BE1TS-21	7314150344178	8	24,56	316
BE1TS-22	7314150344185	8	44,03	316
BE1TS-24	7314150344192	8	40,26	316
BE1TS-6	7314150344024	10	25,86	316
BE1TS-7	7314150344031	10	25,86	316
BE1TS-8	7314150344048	10	28,42	316
BE1TS-9	7314150344055	10	29,62	316
BE1TS-S7	7314150344208	1	187,94	316
BE200CAB250SH10	7314150165452	1	2.526,98	360
BE200CAB250SH25	7314150165469	1	3.497,70	360
BE200CAB250SH3	7314150165445	1	1.684,68	360
BE200CAB40F1	7314150165391	1	1.099,04	360
BE200CAB55F1	7314150165407	1	770,13	360
BE200CAB55F3	7314150165414	1	1.018,83	360
BE200CAB58SR1	7314150165421	1	786,19	360
BE200CAB58SR3	7314150165438	1	1.042,90	360
BE200CAB80SR1	7314150165384	1	410,50	360
BE200CAB80SR3	7314150165476	1	788,05	360
BE200MAG4	7314150245192	1	70,02	360
BE200MAG5	7314150165513	1	75,40	360
BE200MAG80	7314150165551	1	74,10	360
BE200MIR4035	7314150245161	1	67,13	360
BE200MIR4055	7314150245185	1	67,13	360
BE200MIR5535	7314150165483	1	75,41	360
BE200MIR5545	7314150165490	1	75,41	360
BE200MIR5555	7314150165506	1	75,41	360
BE200MIR8035	7314150165520	1	74,10	360
BE200MIR8045	7314150165537	1	74,10	360
BE200MIR8055	7314150165544	1	74,10	360
BE220	7314150170005	1	242,36	360
BE230	7314150182633	1	179,00	303
BE239	7314150243143	1	94,25	303
BE240	7314150239917	1	992,74	303
BE240-CAT	7314150289417	1	107,72	303
BE250	7314150169924	1	47,13	313
BE251200	7314150249343	1	99,64	334
BE2512005	7314150249350	1	78,10	333
BE2512008	7314150249367	1	83,48	334
BE251A	7314150540136	12	47,13	313
BE253	7314150250806	1	119,84	313
BE2541	7314150251797	1	16,58	314
BE2542	7314150251803	1	6,33	314
BE254A	7314150446070	1	112,93	314
BE254A-01	7314150453405	1	41,05	314
BE256-155	7314150205875	1	9,43	314
BE256-178	7314150205882	1	12,12	314
BE256-250	7314150205899	1	16,15	314
BE256M	7314150205851	1	45,76	314
BE256P3	7314150205868	1	33,67	314
BE257	7314150205844	8	103,36	304
BE25710	7314150230549	1	17,11	304
BE25718	7314150230532	1	17,11	304
BE2572	7314150230556	1	12,13	304
BE2576	7314150230525	1	15,04	304
BE258	7314150251780	1	124,62	314
BE301	7314150430871	2	456,77	335
BE301CM	7314150430888	50	62,80	335
BE301CM-01	7314150430956	20	32,35	335
BE301CM-02	7314150430963	20	32,35	335
BE310	7314150205943	8	80,79	336
BE400P24	7314150205806	1	424,13	309
BE400P2401	7314150230600	1	27,90	310
BE400P2402	7314150230617	1	27,90	310
BE400P2403	7314150230624	1	24,68	310
BE400P2404	7314150230631	1	16,08	310
BE400P2405	7314150230648	1	16,08	310
BE400P2406	7314150230655	1	16,08	310
BE400P2407	7314150230662	1	16,08	310
BE400P2408	7314150230679	1	16,08	311
BE400P2409	7314150230686	1	16,08	311
BE400P241	7314150230563	1	113,96	309
BE400P2410	7314150230693	1	16,08	311
BE400P2411	7314150230709	1	16,08	311
BE400P2412	7314150230716	1	16,08	311
BE400P2413	7314150230723	1	16,08	311
BE400P2414	7314150230730	1	16,08	311
BE400P2415	7314150230747	1	17,29	311
BE400P2416	7314150230754	1	16,99	311
BE400P2417	7314150230761	1	16,99	312
BE400P2418	7314150230778	1	16,99	312
BE400P2419	7314150230785	1	16,99	312
BE400P242	7314150230570	1	11,59	309
BE400P2420	7314150237647	1	42,89	312
BE400P243	7314150230587	1	11,59	310
BE400P244	7314150230594	1	22,44	310
BE401	7314150240593	1	10,69	309
BE410	7314150205813	4	263,90	312
BE4101	7314150230792	1	11,58	312
BE5008	7314150239344	1	102,21	306
BE5008-10	7314150239269	1	15,75	306
BE5008-15	7314150239276	1	15,75	306
BE5008-20	7314150239283	1	15,75	306
BE5008-25	7314150239290	1	15,75	306



BE5008-27	7314150239306	1	15,75	306
BE5008-30	7314150239313	1	15,75	306
BE5008-40	7314150239320	1	15,75	306
BE5008-45	7314150239337	1	15,75	306
BE500P24	7314150169955	5	148,11	303
BE500P2401	7314150209569	1	11,56	303
BE500P2402	7314150209682	1	11,26	303
BE500P2403	7314150209736	1	12,52	303
BE500P2404	7314150209729	1	12,68	303
BE500P2405	7314150209613	1	13,51	303
BE500P2406	7314150209804	1	17,44	303
BE500P2407	7314150209781	1	17,44	303
BE500P2408	7314150209743	1	6,53	303
BE500P2409	7314150209750	1	6,47	303
BE500P2410	7314150209637	1	6,47	303
BE500P2411	7314150209644	1	6,47	303
BE500P2412	7314150209699	1	6,47	303
BE500P2413	7314150209705	1	6,47	303
BE500P2414	7314150209798	1	17,60	303
BE500P2415	7314150209675	1	11,96	303
BE500P2416	7314150209620	1	11,31	303
BE500P2417	7314150209583	1	11,12	303
BE500P2418	7314150209576	1	11,56	303
BE500P2419	7314150209767	1	11,12	303
BE500P2420	7314150209590	1	11,56	303
BE500P2421	7314150209606	1	11,56	303
BE500P2422	7314150209774	1	17,44	303
BE500P2423	7314150209668	1	11,26	303
BE500P2424	7314150209712	1	11,26	303
BE501101	7314150274499	1	156,18	296
BE501102	7314150274505	1	157,94	296
BE501203	7314150274529	1	141,37	296
BE501204	7314150274536	1	214,08	296
BE502101	7314150274543	1	468,33	296
BE502102	7314150274550	1	436,74	297
BE502103	7314150274567	1	752,61	297
BE502104	7314150384952	8	110,01	296
BE502106	7314150403370	10	51,77	296
BE502204	7314150274574	1	188,49	297
BE5032	7314150189885	1	90,95	312
BE503201	7314150274581	1	166,96	297
BE5032H10EL	7314150220953	1	10,74	317
BE5032H14	7314150220960	1	31,45	316
BE5032M14	7314150220977	1	35,39	317
BE5032SQ10	7314150220991	1	29,94	312
BE5032SQ8	7314150220984	1	24,77	312
BE5032T55EL	7314150220946	1	11,85	318
BE504102	7314150274666	1	441,63	297
BE504201	7314150274369	1	80,79	297
BE5049	7314150169931	5	114,46	316
BE504901	7314150184576	1	12,35	316
BE504902	7314150184583	1	10,07	317
BE5049H10	7314150184705	1	14,92	316
BE5049H10L	7314150184712	1	22,12	317
BE5049H12	7314150184729	1	18,57	316
BE5049H12L	7314150184736	1	29,69	317
BE5049H4	7314150184590	1	14,92	316
BE5049H4L	7314150184606	1	22,12	317
BE5049H5	7314150184613	1	14,92	316
BE5049H5L	7314150184620	1	22,12	317
BE5049H6	7314150184637	1	14,92	316
BE5049H6L	7314150184651	1	22,12	317
BE5049H7	7314150184668	1	14,92	316
BE5049H7L	7314150184675	1	22,12	317
BE5049H8	7314150184682	1	14,92	316
BE5049H8L	7314150184699	1	22,12	317
BE5049M10	7314150184804	1	14,92	317
BE5049M10L	7314150184811	1	22,12	317
BE5049M12	7314150184828	1	18,57	317
BE5049M12L	7314150184835	1	29,69	317
BE5049M5	7314150184743	1	14,92	317
BE5049M5L	7314150184750	1	22,12	317
BE5049M6	7314150184767	1	14,92	317
BE5049M6L	7314150184774	1	22,12	317
BE5049M8	7314150184781	1	14,92	317
BE5049M8L	7314150184798	1	22,12	317
BE5049T	7314150325474	1	114,46	318
BE5049T20	7314150216048	1	14,42	317
BE5049T20H	7314150184842	1	14,92	317
BE5049T20HL	7314150184859	1	22,12	318
BE5049T20L	7314150221011	1	21,60	318
BE5049T25	7314150216055	1	14,42	317
BE5049T25H	7314150184866	1	14,92	317
BE5049T25HL	7314150184873	1	22,12	318
BE5049T25L	7314150221028	1	21,60	318
BE5049T27	7314150216062	1	14,42	317
BE5049T27H	7314150184880	1	14,92	317
BE5049T27HL	7314150184897	1	22,12	318
BE5049T27L	7314150221035	1	21,60	318
BE5049T30	7314150216079	1	14,42	317
BE5049T30H	7314150184903	1	14,92	317
BE5049T30HL	7314150184910	1	22,12	318
BE5049T30HXL	7314150184927	1	22,22	318
BE5049T30L	7314150221042	1	21,60	318
BE5049T40	7314150216086	1	14,42	317
BE5049T40H	7314150184934	1	14,92	317



BE5049T40HL	7314150184941	1	22,12	318
BE5049T40HXL	7314150185092	1	22,22	318
BE5049T40L	7314150221059	1	21,60	318
BE5049T45	7314150216093	1	14,42	317
BE5049T45H	7314150184958	1	14,92	317
BE5049T45HL	7314150184965	1	22,12	318
BE5049T45HXL	7314150184972	1	22,22	318
BE5049T45L	7314150216123	1	21,60	318
BE5049T50	7314150216109	1	14,42	317
BE5049T50H	7314150184989	1	14,92	317
BE5049T50HL	7314150184996	1	22,12	318
BE5049T50L	7314150221066	1	21,60	318
BE5049T55	7314150216116	1	14,42	317
BE5049T55H	7314150185009	1	14,92	317
BE5049T55HL	7314150185016	1	22,12	318
BE5049T55L	7314150221073	1	21,60	318
BE5049T60	7314150221004	1	21,12	317
BE5049T60H	7314150185023	1	21,60	317
BE5049T60HL	7314150185030	1	32,34	318
BE5049T70HL	7314150185047	1	32,34	318
BE5049T80HL	7314150186532	1	32,34	318
BE505101	7314150274598	1	156,18	298
BE505102	7314150274604	1	677,07	298
BE505203	7314150274611	1	242,36	298
BE505204	7314150274628	1	231,58	298
BE506101	7314150274376	1	210,12	298
BE506102	7314150274635	1	185,40	298
BE506103	7314150274642	1	495,78	299
BE506204	7314150274659	1	288,41	299
BE507101	7314150274673	1	384,55	299
BE507102	7314150274680	1	410,63	299
BE507203	7314150274697	1	403,93	299
BE508101	7314150274765	1	234,29	300
BE508202	7314150274772	1	315,07	300
BE508203	7314150274703	1	296,64	300
BE508204	7314150274710	1	421,63	300
BE509101	7314150274727	1	274,68	300
BE509102	7314150274734	1	458,71	300
BE509103	7314150274383	1	79,45	301
BE509104	7314150274741	1	479,31	301
BE509205	7314150274390	1	70,02	301
BE509206	7314150274406	1	71,38	301
BE509207	7314150274758	1	282,76	301
BE5100	7314150205646	1	95,67	303
BE5101	7314150205721	1	95,96	317
BE510101	7314150274420	1	240,34	301
BE510102	7314150274437	1	53,60	301
BE510125	7314150230877	1	7,08	312
BE510127	7314150230884	1	7,08	312
BE510130	7314150230891	1	7,08	312
BE510140	7314150230907	1	7,08	313
BE510145	7314150230914	1	7,43	313
BE510150	7314150230921	1	7,43	313
BE510155	7314150230938	1	7,43	313
BE510160	7314150230945	1	8,89	313
BE5102	7314150205738	1	95,96	308
BE510203	7314150274789	1	186,78	302
BE510210	7314150231003	1	8,25	308
BE510211	7314150231010	1	9,63	308
BE510212	7314150231027	1	10,01	308
BE510213	7314150231034	1	12,37	308
BE51025	7314150230952	1	7,87	308
BE51026	7314150230969	1	7,87	308
BE51027	7314150230976	1	7,87	308
BE51028	7314150230983	1	8,25	308
BE51029	7314150230990	1	8,25	308
BE5103	7314150205745	1	85,62	308
BE510304	7314150274444	1	116,74	302
BE510310	7314150231072	1	8,21	308
BE510312	7314150231089	1	9,94	308
BE510314	7314150231096	1	13,62	308
BE51035	7314150231041	1	8,21	308
BE51036	7314150231058	1	8,21	308
BE51038	7314150231065	1	8,21	308
BE511101	7314150274451	1	79,65	302
BE511102	7314150274468	1	63,17	302
BE511203	7314150274796	1	336,61	302
BE512201	7314150274475	1	2.181,26	304
BE513201	7314150274802	1	531,85	302
BE5150P27	7314150205790	1	370,90	313
BE5150P271	7314150230808	1	123,06	313
BE5150P272	7314150230815	1	34,37	313
BE5150P273	7314150230822	1	224,42	313
BE5200	7314150205905	1	200,63	317
BE52001	7314150230433	1	22,84	317
BE52002	7314150230440	1	22,84	317
BE52003	7314150230457	1	104,45	317
BE523106	7314150178391	1	62,01	302
BE530001	7314150205912	1	167,26	317
BE5350	7314150206049	5	262,57	305
BE5350C1	7314150230389	1	40,00	305
BE5350C2	7314150230396	1	40,00	305
BE5350C3	7314150230402	1	40,00	305
BE5350C4	7314150230419	1	20,68	305
BE5350C5	7314150230426	1	168,80	305
BE5400P	7314150245086	1	181,78	303



BE5401D



BE5401D	7314150245062	1	658,42	303
BE5500	7314150403233	25	53,06	314
BE550010	7314150432936	1	9,84	315
BE550011	7314150432943	1	9,84	315
BE550012	7314150432950	1	9,84	315
BE550014	7314150432967	1	9,84	315
BE550017	7314150432974	1	10,29	315
BE550019	7314150432981	1	10,61	315
BE61110	7314150167449	12	35,59	319
BE61110-1	7314150167463	100	5,93	319
BE61155	7314150167456	12	38,48	319
BE61155-1	7314150167470	1	7,70	319
BE62110	7314150403332	10	38,18	319
BE62155	7314150403349	10	41,41	319
BE6217	7314150169702	1	82,14	321
BE621701	7314150232642	1	6,42	321
BE621702	7314150232659	1	6,42	321
BE621703	7314150232666	1	6,42	321
BE621704	7314150232673	1	6,42	321
BE621705	7314150232680	1	6,42	321
BE621706	7314150232697	1	6,42	321
BE621707	7314150232703	1	6,42	321
BE621708	7314150232710	1	6,42	321
BE621709	7314150232727	1	6,42	321
BE621710	7314150232734	1	6,42	321
BE621711	7314150232741	1	6,42	321
BE621712	7314150232758	1	6,42	321
BE621713	7314150232765	1	6,42	321
BE621714	7314150232772	1	6,42	321
BE621715	7314150232789	1	6,42	321
BE621716	7314150232796	1	14,09	321
BE621717	7314150232802	1	14,09	321
BE630	7314150169580	3	185,81	320
BE63010015F	7314150232598	25	13,46	320
BE63010615F	7314150232604	1	13,46	320
BE63010815F	7314150232611	1	13,46	320
BE63010818F	7314150232628	1	13,46	320
BE630246F	7314150169597	50	26,00	320
BE6302712F	7314150412846	5	22,65	320
BE630276F	7314150169603	50	26,00	320
BE630326F	7314150169610	50	26,00	320
BE630366F	7314150169627	100	26,00	320
BE630386F	7314150169634	50	26,00	320
BE63064514F1	7314150340095	1	23,56	320
BE63064514F2	7314150340101	1	24,10	320
BE6306514F	7314150232123	12	13,46	320
BE630656714F	7314150232130	12	13,46	320
BE63066514F	7314150169641	25	26,00	320
BE630666F	7314150232116	1	13,46	320
BE6306814F	7314150232154	1	13,46	320
BE6307314F	7314150232161	1	13,46	320
BE6307414F	7314150370108	10	19,41	321
BE6307415F	7314150232178	1	13,46	320
BE630747615F	7314150232307	12	13,46	320
BE630757715F	7314150232321	1	13,46	320
BE6307612F	7314150232345	12	13,46	320
BE6307614F	7314150232369	12	13,46	320
BE6307630F	7314150232437	1	13,46	320
BE630768F	7314150232468	1	13,46	320
BE6307815F	7314150232475	12	13,46	320
BE6308015F	7314150232482	1	13,46	320
BE630808215F	7314150232499	1	13,46	320
BE6308616F	7314150232505	1	13,46	320
BE6308618F	7314150232512	1	13,46	320
BE6309015F	7314150232529	12	13,46	320
BE6309210F	7314150232536	1	13,46	320
BE6309315F	7314150232543	1	13,46	320
BE6309336F	7314150232550	1	13,46	320
BE6309345F	7314150232567	1	13,46	320
BE6309515F	7314150232574	1	13,46	320
BE6309618F	7314150232581	1	13,46	320
BE64350	7314150169672	1	53,18	319
BE64350CH	7314150169696	1	39,72	319
BE64520	7314150169665	1	63,29	319
BE64520CH	7314150169689	1	50,02	319
BE65F65120	7314150169658	12	14,82	319
BE65R106160	7314150170036	1	131,95	320
BE65R65120	7314150170012	1	29,62	320
BE65R80120	7314150170029	1	113,10	320
BE66152A	7314150492534	6	21,77	319
BE6701VAG	7314150333875	1	24,24	321
BE68	7314150237876	1	6,58	321
BE6810	7314150237869	1	13,33	321
BE6810Z	7314150430765	12	31,40	321
BE6FCP	7314150438907	30	44,41	315
BE6OF108	7314150434572	50	33,79	319
BE6OFW	7314150435784	5	60,95	319
BE700	7314150206087	1	85,56	312
BE700BP2	7314150206100	1	78,86	312
BE700SP15	7314150206094	1	37,19	312
BE74-55100	7314150169733	1	47,18	309
BE74-57125	7314150169511	1	48,58	309
BE74-57125L	7314150169535	1	52,89	309
BE74-80120	7314150169740	1	50,02	309
BE74-90175	7314150169528	1	72,86	309
BE76101	7314150240005	1	62,49	305



BE762	7314150384983	12	12,88	305
BE800P12	7314150205677	1	72,72	313
BELMS12OBDL	7314150340323	8	72,34	337
BELP1224	7314150177882	1	87,53	340
BELS12	7314150170579	1	92,91	340
BELT1213A	7314150493104	20	309,74	339
BELT127	7314150177899	1	106,37	339
BELT2415A	7314150493098	20	360,75	340
BELT247N	7314150170586	1	115,80	340
BELT247S	7314150170593	1	115,80	340
BELTKEY	7314150177875	1	177,73	339
BELTRP16	7314150169917	1	215,43	340
BELTRP1601	7314150231935	1	22,65	340
BELTRP1602	7314150231942	1	2,15	340
BELTRP1603	7314150231959	1	23,80	340
BELTRP1604	7314150231966	1	2,15	340
BELTRP1605	7314150231973	1	22,65	340
BELTRP1606	7314150231980	1	2,15	340
BELTRP1607	7314150231997	1	21,24	340
BELTRP1608	7314150232000	1	22,65	340
BELTRP1609	7314150232017	1	17,94	340
BELTRP1610	7314150232024	1	19,87	340
BELTRP1611	7314150232031	1	22,10	340
BELTRP1612	7314150232048	1	23,11	340
BELTRP1613	7314150232062	1	15,15	340
BELTRP1614	7314150232079	1	17,92	340
BELTRP1615	7314150232086	1	17,92	340
BELTRP1616	7314150232093	1	17,92	340
BFRL11	7314150306534	1	60,78	358
BG1S125	7314150416431	20	166,95	340
BH110000A-02	7314150273669	1	104,98	351
BH110000A-04	7314150273683	1	12,23	351
BH110000A-EXT	7314150291946	1	138,73	351
BH110000B	7314150516414	1	1.581,05	351
BH11500	7314150178797	1	579,46	350
BH11500-01	7314150182220	1	25,19	355
BH11500-02	7314150182237	1	17,73	351
BH11500-04	7314150182275	1	6,63	351
BH12000	7314150178803	1	515,08	350
BH13000	7314150178810	1	396,61	350
BH13000-02	7314150182244	1	22,57	351
BH13000L	7314150301980	1	1.249,05	351
BH13000L-01	7314150301997	1	16,90	355
BH13000QA	7314150403295	1	582,96	351
BH15000A-01	7314150273515	1	27,18	355
BH15000A-02	7314150273522	1	57,82	351
BH15000A-04	7314150273546	1	4,62	351
BH15000A-EXT	7314150291939	1	102,75	351
BH15000B	7314150516407	1	1.055,75	351
BH1A1500-04	7314150265299	1	33,57	355
BH1A1500A	7314150460946	1	368,79	350
BH1A1500A-05	7314150477302	40	10,28	351
BH1A2500-03	7314150226856	1	77,84	351
BH1A2500-04	7314150226863	1	59,32	355
BH1A2500A	7314150460953	1	565,08	350
BH1CB1000	7314150243204	1	179,01	351
BH1CD680	7314150330379	1	198,30	354
BH1CD680ST	7314150330386	1	97,34	354
BH1EU3000	7314150245000	1	254,95	350
BH1EU3000-01	7314150250004	1	13,64	351
BH1EU3000-03	7314150249893	1	6,81	351
BH1EU3000-08	7314150249947	1	24,14	355
BH1M1000	7314150237845	1	862,74	350
BH1S45	7314150292295	1	746,86	351
BH1S45-01	7314150311194	1	22,97	355
BH1S45-03	7314150311217	1	10,90	351
BH230	7314150264070	1	3.347,99	352
BH23015	7314150178759	1	2.685,25	352
BH23015C	7314150178742	1	1.673,99	352
BH2402010	7314150178766	1	2.304,96	352
BH2604020	7314150178773	1	3.154,83	353
BH28050	7314150472222	1	3.743,34	353
BH2AC1	7314150213474	1	55,96	353
BH2AC2	7314150213481	1	77,84	353
BH33000	7314150178674	1	64,89	353
BH36000	7314150178681	1	127,62	353
BH3A10000	7314150234660	1	289,34	353
BH3A3000	7314150234646	1	108,15	353
BH3A5000	7314150234653	1	162,23	353
BH3AL2500	7314150302420	1	151,95	353
BH3HD12000	7314150170500	1	219,11	353
BH3HD16000	7314150170524	1	262,90	354
BH3HD20000A	7314150337668	1	315,61	354
BH3HD8000	7314150170494	2	124,17	353
BH3SQ15000	7314150234684	2	247,61	353
BH3SQ7000	7314150234677	2	123,81	353
BH410	7314150178711	1	140,60	350
BH415	7314150178728	2	173,04	350
BH42	7314150178698	1	86,52	350
BH420	7314150178735	1	205,49	350
BH430	7314150178780	2	259,56	350
BH45	7314150178704	1	108,15	350
BH4HP50	7314150477081	1	713,79	350
BH4S12	7314150237920	3	84,36	349
BH4S2	7314150237883	6	34,61	349
BH4S20	7314150237937	1	129,78	349

			€	
BH4S4	7314150237890	6	54,08	349
BH4S50	7314150476879	1	281,19	349
BH4S6	7314150237906	4	64,89	349
BH4S8	7314150237913	4	77,87	349
BH5DP1000QA	7314150270224	1	925,85	354
BH5SP500QA	7314150270217	1	499,11	354
BH5US1000	7314150243174	1	236,42	354
BH6AC1-680A	7314150433544	1	116,80	355
BH6FC1000	7314150178650	1	832,76	355
BH6FC2000	7314150234639	1	1.339,19	355
BH6PC600	7314150234622	1	1.004,39	355
BH7100A	7314150345908	1	7.713,24	341
BH7100SG	7314150299782	1	450,68	342
BH715	7314150237555	1	1.027,43	341
BH715-13	7314150239191	1	148,10	341
BH720	7314150235650	1	1.885,18	341
BH720-22	7314150236961	1	161,54	341
BH720SG	7314150238477	1	150,31	342
BH730	7314150235667	1	2.207,09	341
BH730SG	7314150238484	1	163,99	342
BH750	7314150235674	1	3.242,38	341
BH750SG	7314150238491	1	177,65	342
BH7PS30	7314150474882	2	313,64	341
BH8AC1-500	7314150170463	1	160,11	313
BH8AC2-500	7314150412532	1	472,24	313
BH8AC3-1500A	7314150516391	1	1.879,75	354
BH8AC3-600	7314150351893	1	973,35	354
BH8BC1	7314150242276	1	115,10	349
BH8BC2	7314150242283	1	137,56	349
BH8BC3	7314150242290	10	108,76	349
BH8BC4	7314150242306	6	233,82	349
BH8BC5	7314150242313	6	161,52	349
BH8PR1000	7314150178957	1	397,21	349
BH8PR4000	7314150178940	1	264,91	349
BH9BJ22SLH	7314150246946	1	753,25	352
BH9BJ22SSH	7314150247462	1	733,97	352
BH9BJ23SLH	7314150246953	1	1.011,51	352
BH9BJ23SSH	7314150246960	1	992,20	352
BH9BJ260	7314150247509	1	35,84	352
BH9BJ280	7314150247516	1	41,57	352
BHVG15-250	7314150403745	1	9,88	355
BHVIS06100	7314150167753	1	504,93	332
BHVIS06105	7314150167760	1	572,24	332
BHVIS0670	7314150167692	1	97,62	332
BHVIS0677	7314150167708	1	129,26	332
BHVIS0680	7314150167715	1	137,34	332
BHVIS0685	7314150167722	1	201,97	332
BHVIS0690	7314150167739	1	214,08	332
BHVIS0695	7314150167746	1	336,61	332
BHVIS08100	7314150165711	1	193,21	332
BHVIS08115	7314150165728	1	197,53	332
BHVIS0895	7314150165704	1	175,04	332
BHVIS109BPW12	7314150165759	1	206,96	332
BHVIS111BPW12	7314150165735	1	216,79	332
BHVIS120BPW16	7314150165742	1	240,34	332
BHVIS1265	7314150167685	1	86,16	332
BHVIS80BPW12	7314150165766	1	153,49	332
BHVIS95BPW9	7314150243334	1	158,88	332
BKE850901N	7314150449705	10	14,99	229
BLBT100	7314150179015	1	1.205,08	343
BLBT100AC1	7314150179022	1	312,45	343
BLCR230FR	7314150247356	1	254,92	358
BLCR230SC	7314150247349	1	254,92	358
BLCR24VCL	7314150247370	1	436,99	358
BLCR24VLL	7314150247387	1	589,58	358
BLCR400E	7314150247363	1	902,97	358
BLCRSC1	7314150247530	1	94,79	358
BLCRSC2	7314150247547	1	94,79	358
BLE300	7314150227648	1	187,16	343
BLE301	7314150227662	1	117,15	343
BLE302	7314150227679	1	123,65	343
BLE304	7314150249572	1	166,96	343
BLE305	7314150339341	1	152,56	342
BLEMAT1	7314150477678	1	435,38	342
BLEMAT1BT	7314150477685	1	86,39	342
BLT550	7314150243556	10	75,40	304
BLTFC1	7314150246434	20	95,01	358
BLTS10	7314150246427	20	62,00	358
BLTS7P	7314150246410	58	56,38	358
BMD150	7314150242238	1	12,78	342
BMMTRMS1	7314150274024	1	214,26	339
BMR240	7314150242245	1	22,90	342
BMVAT1000	7314150488360	50	135,91	339
BOD101	7314150205967	1	51,66	321
BOD1016	7314150169979	1	39,06	323
BOD101NWS	7314150269099	1	38,51	321
BOD101T	7314150269150	1	18,43	324
BOD102	7314150205974	1	54,63	321
BOD102NWS	7314150269105	1	42,90	321
BOD102T	7314150269167	1	22,96	324
BOD103	7314150205981	1	54,63	321
BOD103NWS	7314150269112	1	38,51	321
BOD103T	7314150269174	1	18,43	324
BOD104	7314150205998	1	59,05	321
BOD104NWS	7314150269129	1	42,43	321
BOD104T	7314150269181	1	23,71	324

			€	
BOD105	7314150206001	1	62,00	321
BOD105NWS	7314150269136	1	42,43	321
BOD105T	7314150269198	1	26,12	324
BOD106	7314150206018	1	67,18	321
BOD106NWS	7314150269143	1	56,83	321
BOD106T	7314150269204	1	22,33	324
BOD10P64	7314150205950	8	133,31	321
BOD2008	7314150169986	1	45,10	323
BOD2FS	7314150351879	20	15,40	324
BOD301200	7314150169993	1	28,28	323
BOD4200	7314150169436	1	9,83	323
BOD4500	7314150169443	1	11,98	323
BOD54-1	7314150239467	1	11,37	324
BOD54-2	7314150239474	1	13,57	324
BOD54-3	7314150239481	1	9,14	324
BOD5400	7314150169450	1	35,72	324
BOD5450	7314150169474	1	59,35	324
BOD5HD400	7314150169467	1	55,15	324
BOD60	7314150169481	1	52,52	324
BOD6080P12	7314150235407	1	437,61	322
BOD6080P12-01	7314150235438	1	20,33	322
BOD6080P12-02	7314150235445	1	26,14	322
BOD6080P12-03	7314150235452	1	26,14	322
BOD6080P12-04	7314150235469	1	26,14	322
BOD6080P12-05	7314150235476	1	20,33	323
BOD6080P12-06	7314150235490	1	24,17	323
BOD6080P12-07	7314150235506	1	21,16	323
BOD6080P12-08	7314150235513	1	24,17	323
BOD6080P12-09	7314150235520	1	20,33	323
BOD6080P12-10	7314150235537	1	28,12	323
BOD6080P12-11	7314150235544	1	24,17	323
BOD70	7314150169498	1	152,51	324
BOD8901	7314150169016	1	552,04	322
BOD8901AC1	7314150178490	1	89,04	322
BOD8902	7314150169023	1	713,62	322
BOD8903A	7314150265374	1	801,14	322
BOM10X	7314150540549	10	38,11	361
BP-40	7314150453085	1	49,13	573
BP-40-95	7314150487097	12	3,85	573
BP110	7314150135011	1	221,76	279
BP111E	7314150235872	12	309,35	279
BP115	7314150134991	1	202,66	277
BP117	7314150184309	1	262,71	277
BP117EH	7314150184316	1	45,25	279
BP118	7314150235834	1	239,07	277
BP125A	7314150427291	6	697,92	285
BP127	7314150137565	1	394,04	279
BP12718	8414909179002	1	22,53	280
BP127P	7314150427277	1	271,38	279
BP204	7314150184286	1	270,19	281
BP20410320	7314150185948	1	17,25	281
BP20410800	7314150185955	1	9,15	281
BP20425180	7314150185924	1	34,50	281
BP20425220	7314150185931	1	34,50	281
BP204K	7314150184293	1	487,88	281
BP204PAD	7314150185917	1	15,10	281
BP212	7314150134601	1	244,31	281
BP215A	7314150341849	10	65,80	285
BP218	7314150170272	1	25,23	286
BP219	7314150235889	1	21,72	286
BP219L	7314150235896	1	25,25	286
BP219V	7314150307197	1	71,90	286
BP219XL	7314150427192	10	22,55	286
BP222	7314150137572	1	255,20	281
BP233	7314150134748	1	362,53	283
BP254	7314150137633	1	142,56	286
BP255	7314150137640	1	213,83	287
BP255T	7314150427307	1	267,61	287
BP255T-1	7314150427314	1	42,72	287
BP277K	7314150427284	8	277,66	285
BP420M	7314150134618	1	4,56	278
BP421M	7314150134625	1	4,56	278
BP422M	7314150134632	1	4,56	278
BP423M	7314150134649	1	4,56	278
BP424M	7314150134656	1	4,56	278
BP430M	7314150134663	1	4,56	278
BP431M	7314150134670	1	4,56	278
BP432M	7314150134687	1	4,56	279
BP433M	7314150134694	1	4,56	279
BP434M	7314150135837	1	4,56	279
BP500	7314150137992	1	55,44	286
BP51137	7314150134724	1	40,70	281
BP601	7314150134526	1	394,04	281
BP60102	7314150426669	1	55,98	281
BP610	7314150134595	1	394,04	282
BP700	7314150134458	20	204,10	277
BP704	7314150427130	1	212,33	274
BP721	7314150427185	1	182,18	277
BP799	7314150134502	1	202,53	285
BP79912	7314150134717	1	42,74	285
BP809	7314150235841	1	406,48	282
BP80950	7314150275564	1	12,43	282
BP810	7314150235858	1	353,76	282
BP811	7314150235865	1	136,99	284
BP814	7314150184262	10	254,92	274
BP814A	7314150304349	10	496,77	274





BP815	7314150134311	1	254,92	274
BP815K1	7314150181957	1	372,58	274
BP815K2	7314150181964	1	320,29	274
BP817	7314150134106	1	620,95	275
BP820	7314150134465	1	217,66	277
BP821	7314150134472	1	255,28	277
BP822	7314150134984	1	165,49	278
BP822E	7314150184279	10	202,66	278
BP823	7314150135004	1	420,31	279
BP824	7314150134489	1	336,69	283
BP825	7314150134496	1	359,70	282
BP826	7314150137459	1	364,77	283
BP827	7314150137442	1	405,09	283
BP828	7314150427260	1	276,40	283
BP830CISB	7314150439799	1	36,70	280
BP830ESB	7314150439751	1	27,24	280
BP830EWB	7314150439768	1	27,24	280
BP830K	7314150427208	4	521,40	280
BP830MISB	7314150439782	1	36,70	280
BP830SBA	7314150439805	1	23,87	280
BP830SSB	7314150439775	1	36,70	280
BP830SW	7314150439744	1	27,24	280
BP901	7314150336012	1	986,99	276
BP901L	7314150336029	1	1.000,05	276
BP905L	7314150336234	2	1.305,95	276
BP905P	7314150336210	2	1.300,73	276
BP905S	7314150336227	2	1.292,89	276
BP909NE	7314150187980	1	97,68	285
BP909NF	7314150187973	1	79,64	285
BP909TE	7314150187942	1	37,56	284
BP909TF	7314150187911	1	29,31	284
BP909TH	7314150187959	1	37,56	284
BP909TSP	7314150187966	1	29,31	285
BP909TTP	7314150187935	1	29,31	284
BP909TWF	7314150187928	1	29,31	284
BP910	7314150427246	5	182,18	284
BP91BL	7314150192779	1	3,02	277
BP91BS	7314150192786	1	3,02	277
BPA823	7314150427161	1	154,54	282
BPGG3515	7314150134823	1	34,68	283
BPGG3525A	7314150134830	1	34,68	283
BPGG3525B	7314150134847	1	38,63	283
BPGG5725	7314150134861	1	34,68	284
BPGG9057	7314150134878	1	84,32	284
BPPK30	7314150134854	1	34,68	283
BPBL00900	7314150358335	5	64,39	344
BPBL30900	7314150360451	5	64,39	344
BPBL70600	7314150360468	5	56,62	344
BPBL90600	7314150358366	5	57,59	344
BPBL54	7314150360475	2	237,49	344
BPBSC156	7314150134816	1	51,04	283
BPBU18	7314150134755	1	56,74	284
BPBU24	7314150134762	1	56,74	284
BPBU36	7314150134779	1	64,63	284
BPBU60	7314150134786	1	69,36	284
BPBU90	7314150134793	1	84,32	284
BPC813	7314150296408	10	254,92	274
BPC813K1	7314150331253	1	344,15	274
BPC814	7314150296392	10	294,15	275
BPC815	7314150296385	1	307,21	275
BPC815K1	7314150331208	1	592,19	275
BPC815K2	7314150331215	1	507,40	275
BPC815K3	7314150331222	1	523,78	275
BPC815K4	7314150331239	1	548,31	275
BPC815K6	7314150331284	1	483,01	275
BPC816	7314150296415	10	301,40	274
BPC817	7314150296422	4	699,40	275
BPC817K1	7314150331260	1	1.037,16	276
BPC817K2	7314150331277	1	1.019,36	276
BPC823	7314150427147	1	157,04	282
BPC825	7314150427154	1	183,43	282
BPCVB1	7314150384792	6	226,49	334
BPG824	7314150427253	10	314,10	283
BPH1010A	7314150330010	1	47,27	287
BPH1010B	7314150341757	1	38,37	287
BPH1310A	7314150330003	1	85,63	287
BPHRC1015	7314150247400	1	287,59	287
BPHRC1020	7314150247417	1	390,88	287
BPHRC1316	7314150247455	1	424,87	287
BPHRC815	7314150247394	1	260,14	287
BPHRO1315	7314150247431	1	575,20	288
BPHRSC	7314150247448	1	94,79	287
BPHVLP01	7314150138937	1	194,78	285
BPHVLP0112	7314150165872	1	22,86	286
BPHVLP0114	7314150165889	1	22,86	286
BPHVLP0117	7314150165896	1	22,86	286
BPHVLP0120	7314150165902	1	22,86	286
BPM917BOOT	7314150281664	1	15,32	276
BPM91MK1	7314150186938	1	5,81	276
BPM91MK2	7314150186945	1	5,81	276
BPN010	7314150219728	1	201,92	286
BPN21201	7314150134731	1	141,86	282
BPN22201	7314150138074	1	167,09	282
BPN251	7314150137589	1	16,08	287
BPOC15	7314150360673	12	79,47	314
BPR821	7314150427178	1	263,84	277



BPSJ	7314150427239	1	30,15	288
BPSJL	7314150439812	1	35,18	288
BS1000	7314150170081	1	390,48	336
BS100001	7314150232819	1	17,76	336
BS100002	7314150232826	1	17,76	336
BS100003	7314150232833	1	17,76	336
BS100004	7314150232840	1	17,76	336
BS100005	7314150232857	1	17,76	336
BS100006	7314150232864	1	17,76	336
BS100007	7314150232871	1	17,76	336
BS100008	7314150232888	1	17,76	336
BS100009	7314150232895	1	17,76	336
BS100010	7314150232901	1	14,52	336
BS100011	7314150232918	1	14,52	336
BS100012	7314150232925	1	14,52	336
BS100013	7314150232932	1	12,09	336
BS100014	7314150232949	1	12,09	336
BS100015	7314150232956	1	12,09	336
BS100016	7314150232963	1	12,09	336
BS100017	7314150232970	1	12,09	336
BS100018	7314150232987	1	12,09	336
BS100019	7314150232994	1	12,09	336
BS100020	7314150233007	1	12,09	336
BS100021	7314150233014	1	12,09	336
BS100022	7314150233021	1	14,52	336
BS100023	7314150233038	1	14,52	336
BS100024	7314150233045	1	14,52	336
BS100025	7314150233052	1	14,52	336
BS100026	7314150233069	1	14,52	336
BS100027	7314150233076	1	14,52	337
BS100028	7314150233083	1	14,52	337
BS100029	7314150233090	1	12,09	337
BS100030	7314150233106	1	12,09	337
BS100031	7314150233113	1	12,09	337
BS100032	7314150233120	1	12,09	337
BS100033	7314150233137	1	12,09	337
BS100034	7314150233144	1	12,09	337
BS100035	7314150233151	1	16,23	337
BS100036	7314150233168	1	16,23	337
BS100037	7314150233175	1	16,23	337
BS100038	7314150233182	1	16,23	337
BS100039	7314150233199	1	16,23	337
BS100PSA1	7314150249282	1	101,56	335
BS10AC2	7314150182343	1	592,45	336
BS15	7314150206117	1	666,50	336
BS15125	7314150231775	1	77,34	336
BS15125C	7314150231812	1	6,87	336
BS15160	7314150231782	1	82,72	336
BS15160C	7314150231829	1	6,87	336
BS15212	7314150231799	1	88,15	336
BS15212C	7314150231836	1	6,87	336
BS1550	7314150231805	1	44,66	336
BS25	7314150416103	1	227,77	336
BS30AC1	7314150383504	1	479,34	336
BS30PG	7314150436644	1	2.474,20	336
BS40VAG	7314150430642	20	63,95	334
BS45BMW	7314150430659	20	35,53	334
BS52	7314150329212	1	249,09	334
BS5228341	7314150329229	1	88,86	333
BS5234401	7314150329236	1	88,86	333
BS5239451	7314150329243	1	88,86	333
BS54	7314150243341	1	64,63	334
BS56	7314150430826	6	35,25	334
BS618	7314150242368	1	53,87	335
BS623	7314150242375	1	105,28	335
BSSHE3	7314150251858	1	101,46	333
BT10P3	7314150205639	1	123,86	344
BT10P325	7314150231706	40	40,92	344
BT10P330	7314150231713	1	44,71	344
BT10P338	7314150231720	1	51,00	344
BT15P5	7314150205837	1	81,19	332
BT15P524	7314150231737	1	12,61	332
BT15P530	7314150231744	1	15,16	332
BT15P532	7314150231751	1	16,32	332
BT15P536	7314150342129	1	21,76	332
BT20P26	7314150205820	1	693,43	335
BT20P49	7314150385041	1	2.523,68	335
BTL-3-13	7314150333349	12	7,25	538
BTL-6-13	7314150333356	12	9,26	538
BTR-3-13	7314150333332	12	7,25	538
BTR-6-13	7314150333363	12	9,26	538
BUC100	7314150169962	1	100,99	319
BUC110	7314150206025	1	46,46	319
BUC50	7314150182329	1	64,63	318
BUCKET - 1446-CS	7314150534555	1	646,84	585
BUCKET - EMPTY	7314150511037	6	16,48	585
BUCKET 1446	7314150436446	75	8,36	585
BUCKET-1446-FLOAT	7314150539550	1	796,14	585
BUCPE	7314150243259	1	754,01	318
BUCPE3SDH	7314153024183	1	203,66	318
BUCPE3SH	7314150243471	1	200,03	318
BUCPEF	7314150244942	1	77,90	318
BUCPEF1	7314150245116	1	6,74	318
BWB14	7314150170166	2	484,49	334
BWB1418S4	7314150365593	6	72,97	342
BWB1922S4	7314150365609	6	82,25	342



BWBB	7314150407828	200	8,41	330
BWC1	7314150365586	25	17,25	331
BWHEHS	7314150251841	1	245,76	333
BWHEP	7314150251834	1	235,77	333
BWHEPS	7314150264087	1	457,51	332
BWHEPSH8	7314150264889	1	598,30	333
BWHEPSSH8	7314150264896	1	968,25	332
BWHPJ12	7314150403257	4	304,14	335
BWHTRS12	7314150384808	15	220,01	330
BWMSP15	7314150239740	1	103,46	369
BWMSP1501	7314150239757	1	5,12	369
BWMSP1502	7314150239764	1	5,12	369
BWMSP1503	7314150239771	1	5,12	369
BWMSP1504	7314150239788	1	5,12	369
BWMSP1505	7314150239795	1	5,12	369
BWMSP1506	7314150239801	1	5,12	369
BWMSP1507	7314150239817	1	5,12	369
BWMSP1508	7314150239818	1	5,12	369
BWMSP1509	7314150239825	1	5,12	369
BWMSP1510	7314150239832	1	5,12	369
BWMSP1511	7314150239849	1	5,12	369
BWMSP1512	7314150239856	1	5,58	369
BWMSP1513	7314150239863	1	5,58	369
BWMSP1514	7314150239870	1	5,58	369
BWMSP1515	7314150239887	1	5,58	369
BWP150	7314150170159	1	24,24	331
BWSH5	7314150251810	2	342,91	333
BWSH51	7314150251827	1	18,31	333
BWSH8	7314150255191	1	444,37	333
BWSHK21	7314150403271	25	16,83	329
BWSMB15	7314150365074	25	14,46	328
BWSMB17	7314150329656	1	16,15	329
BWSS12P3	7314150170128	20	40,26	328
BWSS12P317	7314150203451	1	13,33	328
BWSS12P317L	7314150330065	1	23,97	329
BWSS12P319	7314150203468	1	14,15	328
BWSS12P319L	7314150330072	1	24,10	329
BWSS12P321	7314150203475	1	14,15	328
BWSS12P321L	7314150330089	1	24,24	329
BWSS12P3L	7314150330096	1	97,06	329
BWSS12P5	7314150170135	1	61,94	328
BWSS12P522	7314150203482	1	16,15	328
BWSS12P524	7314150203499	1	16,15	328
BWTB12P100	7314150329830	1	23,56	330
BWTB12P110	7314150329847	1	23,56	330
BWTB12P120	7314150329854	1	23,56	330
BWTB12P135	7314150329861	1	23,56	330
BWTB12P150	7314150329878	1	23,56	330
BWTB12P160	7314150329885	1	23,56	330
BWTB12P175	7314150329892	1	23,56	330
BWTB12P190	7314150329908	1	23,56	330
BWTB12P200	7314150329915	1	23,56	330
BWTB12P5	7314150329991	1	119,84	330
BWTB12P90	7314150329823	1	23,56	330
BWTDG1	7314150403400	50	38,18	331
BWTPG1	7314150351886	10	53,32	331
BWTPMSS4C	7314150347100	25	34,34	332
BWTPMSS9	7314150347124	8	321,80	331
BWTSP16	7314150170296	1	291,59	330
BWTSP1608	7314150203284	1	24,20	330
BWTSP1610	7314150203291	1	15,27	330
BWTSP1611	7314150203307	1	15,27	330
BWTSP1612	7314150203314	1	15,27	330
BWTSP1613	7314150203321	1	15,27	330
BWTSP1614	7314150203338	1	15,27	330
BWTSP1616	7314150203345	1	16,36	330
BWTSP1617	7314150203352	1	16,36	330
BWTSP1618	7314150203369	1	16,36	330
BWTSP1619	7314150203376	1	16,36	330
BWTSP1621	7314150203383	1	31,90	330
BWTSP1622	7314150203390	1	32,24	330
BWTSP1624	7314150203406	1	32,99	330
BWTSP1627	7314150203413	1	33,62	330
BWTSP317L	7314150335480	1	40,33	329
BWTSP319L	7314150335497	1	43,76	329
BWTSP321L	7314150335503	1	47,46	329
BWTSP3L	7314150335473	1	132,62	329
BWTSP6	7314150240043	1	94,54	329
BWTSP617	7314150242399	1	18,93	329
BWTSP619	7314150242405	1	18,93	329
BWTSP621	7314150242412	1	18,93	329
BWTSP622	7314150242429	1	19,65	329
BWTSP624	7314150242436	1	19,65	329
BWTSP7	7314150170302	1	266,34	329
BWTSP732	7314150203420	1	78,12	330
BWTSP736	7314150203437	1	92,72	330
BWTSP741	7314150203444	1	107,99	330
BWTVCTT355	7314150347179	1	28,13	332
BWXW1	7314150167661	1	35,01	328
BWXW2	7314150167678	4	105,02	328
BWXW3	7314150214624	1	32,32	328
BWXW4	7314150214631	1	109,08	328
BZWBT0132450	7314150165674	1	176,49	330
BZWBT0132600	7314150165681	1	176,49	330
C0312I03	7314150501298	5	13,50	147
C0313M03	7311518100636	1	14,52	144



C0313M03X	7311518182045	1	15,12	144
C0616AL06	7311518181826	1	33,46	145
C0616M03X	7311518204679	1	30,84	144
C0616M06	7311518100667	1	27,83	144
C0616M06X	7311518100681	1	29,23	144
C0618I06	7314150501311	5	23,94	147
C0618S06	7314150501342	5	21,97	146
C0820M06	7311518100711	1	39,92	144
C0820M06X	7311518100735	1	41,93	144
C1020I06	7314150501373	5	32,23	147
C1020M06	7311518100766	1	40,73	144
C1020M06X	7311518100780	1	42,74	144
C1020S06	7314150501403	5	29,56	146
C1225AL06	7311518187637	1	63,92	145
C1225I06	7314150506743	5	61,23	147
C1225M06	7311518100810	1	60,49	144
C1225M06X	7311518100834	1	67,43	144
C1225M08X	7311518187996	1	63,92	144
C1225S06	7314150501465	5	46,46	146
C1625M06	7311518192266	1	74,00	144
C1625M06X	7311518187378	1	77,63	144
C1625M08	7311518100902	1	74,00	144
C1625M08X	7311518100926	1	77,63	144
C1997LM/9P	7314150510375	1	36,77	225
C1997TORX/9P	7314150510382	1	36,77	226
C3140	7314150393312	10	36,36	234
C3140IP	7314150391158	10	35,95	234
C3230	7314150393329	10	49,18	237
C3230IP	7314150391189	10	48,70	237
C3330	7314150393336	10	35,29	234
C3330IP	7314150391196	10	34,88	234
C3330R	7314150393343	10	35,29	234
C3330R IP	7314150391202	10	34,88	234
C3340R	7314150393350	10	36,19	234
C3340R IP	7314150391219	10	36,24	234
C3430	7314150393367	10	36,60	246
C3430IP	7314150391226	10	36,19	245
C3530	7314150393374	10	36,95	246
C3530IP	7314150391233	10	36,19	246
C3630	7314150393381	10	41,13	242
C3630IP	7314150391240	10	40,30	242
C3640	7314150393398	10	42,33	242
C3640IP	7314150391257	10	41,37	242
C3745	7314150393404	10	39,16	243
C3745IP	7314150391264	10	38,51	243
C3790	7314150393411	10	39,52	243
C3790IP	7314150391271	10	38,51	243
C3830	7314150393428	10	36,95	242
C3830IP	7314150391288	10	36,22	242
C3840	7314150393435	10	36,95	242
C3840IP	7314150391295	10	36,24	242
C3901/3	7314150392797	1	123,40	257
C3902/3	7314150399604	1	113,00	258
C3903/2-6	7314150466481	1	113,62	258
CFP250	7314150400669	6	23,78	612
CHALK-BLUE	7314150128686	6	3,09	542
CHALK-RED	7314150128709	6	3,09	542
CHALK-WHITE	7314150179671	6	3,28	542
CHALK-YELLOW	7314150128693	6	3,09	542
CL-1221	7314150127122	6	12,17	542
CL-1221-SET	7314150188574	4	17,68	542
CL-1331	7314150347728	48	18,76	542
CL-1441	7314150347735	36	24,27	542
CLIPS-1/2	7314153003201	25	0,37	95
CLIPS-1/4	7314153003188	25	0,37	82
CLIPS-3/8	7314153003195	25	0,37	88
CR B 01	7314150215409	60	27,62	254
CR B 02	7314150215416	60	26,57	254
CR B 03	7314150215423	60	27,04	254
CR B 05	7314150215454	2	53,76	255
CR B 06	7314150215461	2	107,50	255
CR L 01	7314150215911	1	398,68	257
CR L 02	7314150215928	1	294,47	257
CR L 03	7314150215935	1	448,52	257
CR OV 01	7314150489978	1	157,47	256
CR SA H01	7314150489992	1	219,33	255
CR SA H16	7314150508990	1	240,45	256
CR SA S01	7314150490011	1	212,58	256
CR SA T01	7314150490035	1	208,08	256
CR W 01	7314150215492	1	155,55	255
CR W 02	7314150215508	1	129,86	255
CR W 03	7314150215515	1	129,86	255
CR W 04	7314150215522	1	135,78	256
CR W 05	7314150215539	1	137,88	256
CR W 06	7314150215546	1	145,73	256
CS-SPARE	7314150453030	1	4,44	544
CS150	7314150125241	12	12,75	544
CS300	7314150125258	12	23,72	544
CS400	7314150125265	12	26,40	544
D-DD/S20	7311518280345	4	94,75	178
D/S10	7311518280307	6	61,26	179
D/S14	7311518280314	6	83,71	179
D0303I03	7314150501281	5	13,50	147
D0303M03	7311518100957	1	18,46	144
D0303M03X	7311518182052	1	19,32	144
D0605M03X	7311518197896	1	29,71	144





D0606106	7314150501328	5	22,01	147
D0606M06	7311518100988	1	28,23	144
D0606M06X	7311518101008	1	29,71	144
D0606S06	7314150501359	5	20,17	146
D0807M06	7311518043896	1	29,08	144
D0807M06X	7311518043919	1	30,56	144
D1009M06	7311518035280	1	30,14	144
D1009M06X	7311518035297	1	31,61	144
D1010I06	7314150501380	5	26,46	147
D1010S06	7314150501410	5	24,24	146
D1211AL06	7311518187644	1	50,52	146
D1211AL08	7311518181840	1	50,52	146
D1211M06	7311518035334	1	42,02	144
D1211M06X	7311518035358	1	44,15	144
D1212I06	7314150501441	5	35,69	147
D1212S06	7314150501472	5	32,70	146
D1614M06	7311518192327	1	62,24	144
D1614M06X	7311518187385	1	61,97	144
D1614M08	7311518035389	1	59,00	144
D1614M08X	7311518035402	1	61,99	144
DD/S10	7311518280321	6	60,33	179
DD/S14	7311518280338	4	96,77	178
DOW 175-1	7314152202728	1	39,56	266
DOW 175-11/2	7314152202995	1	54,29	266
DOW 175-2	7314152203022	1	85,12	266
DOW 175-3	7314152203299	1	141,82	266
DOW 176-1	7314152206047	1	51,47	267
DOW 176-11/2	7314152206122	1	66,16	267
DOW 176-2	7314152206399	1	91,07	267
DOW 177-1/2-1	7314152816383	1	49,10	266
DOW 177-11/2	7314152816468	1	62,39	266
DOW 177-2	7314152816543	1	93,22	266
E0308M03	7311518035433	1	23,77	144
E0308M03X	7311518192372	1	25,05	144
E0614M06	7311518035464	1	40,74	144
E0816M06	7311518035518	1	46,16	144
E0816M06X	7311518035532	1	45,97	144
E1015I06	7314150501496	5	32,23	147
E1018M06	7311518035563	1	48,79	144
E1018M06X	7311518035587	1	51,21	144
E1220I06	7314150501526	5	47,21	147
E1222M06	7311518035617	1	56,05	144
E1222M06X	7311518035631	1	58,88	144
E1222M08	7311518172558	1	59,01	144
E1222M08X	7311518199302	1	61,99	144
E1625M06	7311518192440	1	90,33	144
E1625M06X	7311518187392	1	99,35	144
E1625M08	7311518035709	1	90,33	144
E1625M08X	7311518035723	1	94,76	144
EX-14-TEN-C	7311518298333	5	36,62	563
EX-14-VEN-C	7311518298340	10	30,83	563
EX-16-GNP-C	7311518298685	10	32,11	560
EX-19-XT9-C	7311518298302	10	42,70	562
EX-20-LAM-C	7311518298326	10	45,13	563
EX-20-XT11-C	7311518298319	10	44,19	563
EX-22-PLS-C	7311518298357	10	40,34	560
EX-22-U7	7311518300890	10	15,49	562
EX-22-XT7-C	7311518298289	10	44,19	564
EX-22-XT9-C	7311518298296	10	44,19	562
EX-24-XT7-C	7311518298272	10	45,75	564
EX-24P-22	7311518298456	10	23,09	564
EX-LL	7311518298494	4	39,56	566
EX-NPP-22	7311518324162	10	18,90	562
EX-RL	7311518298487	4	39,56	566
EX-RM	7311518298470	4	39,56	566
F0312I03	7314150501502	5	13,50	147
F0313M03	7311518035754	1	14,52	144
F0313M03X	7311518192495	1	15,32	144
F0613M03X	7311518196608	1	31,92	144
F0618AL06	7311518181857	1	42,74	146
F0618I06	7314150501533	5	25,00	147
F0618M06	7311518035792	1	35,69	144
F0618M06X	7311518035815	1	37,51	144
F0618S06	7314150501564	5	22,93	146
F0820M06	7311518035839	1	46,97	144
F0820M06X	7311518035860	1	49,40	144
F1020I06	7314150501595	5	31,55	147
F1020M06	7311518035891	1	45,77	144
F1020M06X	7311518035914	1	47,99	144
F1020S06	7314150501625	5	28,91	146
F1225AL06	7311518187651	1	58,07	146
F1225AL08	7311518181864	1	58,07	146
F1225I06	7314150501656	5	46,66	147
F1225M06	7311518035945	1	58,07	144
F1225M06X	7311518036003	1	60,89	144
F1225M08	7311518035983	1	58,07	144
F1225M08X	7311518192563	1	60,89	144
F1225S06	7314150501687	5	42,76	146
F1625M06	7311518192570	1	88,91	144
F1625M06X	7311518187408	1	88,51	144
F1625M08	7311518036034	1	88,73	144
FCP-1.8-810	7311518123970	4	81,88	600
FCP-2.3-860	7311518123994	2	91,09	600
FCS-1000	7314150321551	6	25,22	545
FCS-600	7314150321537	6	21,69	545
FCS-800	7314150321544	6	23,04	545



FF1A01	7314150228560	1	699,63	395
FF1A02	7314150228591	1	257,26	395
FF1A03	7314150228607	1	208,29	395
FF1A04	7314150227778	1	469,15	395
FF1A051	7314150478446	1	718,11	395
FF1A06	7314150227822	1	414,56	396
FF1A07	7314150227846	1	249,17	396
FF1A08	7314150227976	1	1.652,00	396
FF1A09	7314150227990	1	524,87	396
FF1A1004	7314150286454	1	144,62	396
FF1A1010	7314150320660	1	237,08	397
FF1A1011	7314150339068	1	112,46	397
FF1A102	7314150334841	1	351,75	397
FF1A104	7314150334865	1	201,53	397
FF1A106	7314150335541	1	326,96	397
FF1A11	7314150228034	1	692,99	397
FF1A110	7314150335619	1	259,69	398
FF1A112	7314150335572	1	285,65	398
FF1A114	7314150335633	1	344,67	398
FF1A115	7314150335640	1	232,41	398
FF1A117	7314150335701	1	227,81	398
FF1A118	7314150335732	1	319,88	398
FF1A119	7314150335749	1	297,46	399
FF1A12	7314150228058	1	393,57	399
FF1A121	7314150335718	1	336,41	399
FF1A124	7314150335725	1	201,53	399
FF1A127	7314150336395	1	248,94	399
FF1A128	7314150336586	1	449,73	399
FF1A129	7314150336593	1	352,93	400
FF1A13	7314150228072	1	1.572,64	400
FF1A130	7314150336661	1	711,25	400
FF1A131	7314150336678	1	260,79	400
FF1A132	7314150336685	1	385,27	400
FF1A133	7314150336692	1	154,10	401
FF1A134	7314150336708	1	213,38	401
FF1A135	7314150336715	1	651,98	401
FF1A136	7314150336722	1	438,61	401
FF1A137	7314150336739	1	651,98	401
FF1A138	7314150336746	1	254,87	402
FF1A139	7314150336753	1	189,67	402
FF1A14	7314150228089	1	695,60	402
FF1A141	7314150336777	1	734,96	402
FF1A142	7314150338573	1	628,26	402
FF1A143	7314150338580	1	254,87	402
FF1A145	7314150338603	1	302,28	403
FF1A146	7314150338610	1	616,41	403
FF1A147	7314150338627	1	260,79	403
FF1A15	7314150228096	1	768,30	403
FF1A153	7314150350445	1	354,11	403
FF1A154	7314150350476	1	183,32	404
FF1A16	7314150228102	1	560,41	404
FF1A164	7314150350957	1	565,86	404
FF1A165	7314150350964	1	320,82	404
FF1A167	7314150350988	1	330,50	404
FF1A168	7314150350995	1	219,99	404
FF1A169	7314150351008	1	271,48	405
FF1A170	7314150351800	1	286,44	405
FF1A18	7314150228126	1	324,00	405
FF1A185	7314150358694	1	180,25	405
FF1A189	7314150405961	1	234,88	405
FF1A19	7314150254354	1	453,17	405
FF1A194	7314150431496	1	676,01	406
FF1A195LM	7314150455850	1	401,02	389
FF1A196LM	7314150455874	1	504,14	390
FF1A197LM	7314150455881	1	423,94	390
FF1A198LM	7314150455898	1	286,44	390
FF1A199LM	7314150455904	1	607,26	390
FF1A20	7314150254361	1	509,67	406
FF1A200LM	7314150455928	1	492,68	390
FF1A201LM	7314150455935	1	263,53	391
FF1A202LM	7314150455966	1	171,87	390
FF1A203LM	7314150455973	1	160,41	391
FF1A204LM	7314150455980	1	263,53	391
FF1A205LM	7314150455997	1	263,53	391
FF1A206LM	7314150456000	1	366,65	391
FF1A207LM	7314150456017	1	446,85	391
FF1A208LM	7314150456024	1	389,56	392
FF1A209LM	7314150456031	1	320,82	392
FF1A210LM	7314150456062	1	435,39	392
FF1A211LM	7314150456079	1	194,78	392
FF1A212LM	7314150456086	1	217,70	392
FF1A213	7314150437283	1	985,36	392
FF1A214LM	7314150456093	1	343,73	393
FF1A215LM	7314150456109	1	297,90	393
FF1A216LM	7314150456123	1	229,15	393
FF1A218LM	7314150456130	1	630,17	393
FF1A219LM	7314150456147	1	366,65	393
FF1A22	7314150254385	1	837,70	406
FF1A220LM	7314150456154	1	309,36	394
FF1A221LM	7314150456161	1	572,89	394
FF1A222LM	7314150456178	1	389,56	394
FF1A223LM	7314150456185	1	332,27	394
FF1A224LM	7314150456192	1	274,99	394
FF1A225LM	7314150456208	1	286,44	394
FF1A23	7314150254392	1	464,30	406
FF1A230	7314150461455	1	510,82	406

			€	
FF1A2301	7314150286508	1	799,75	407
FF1A235	7314150500666	1	430,73	407
FF1A236	7314150500680	1	453,20	407
FF1A24	7314150254408	1	411,12	407
FF1A25	7314150254415	1	649,66	407
FF1A2501	7314150286492	1	976,78	408
FF1A2503	7314150320677	1	681,61	408
FF1A26	7314150254422	1	469,64	408
FF1A28	7314150254446	1	550,46	408
FF1A29NB	7314150266340	1	315,27	409
FF1A3001	7314150286515	1	273,92	409
FF1A3002	7314150289264	1	347,33	409
FF1A3003	7314150286522	1	307,69	409
FF1A3004	7314150286676	1	535,81	409
FF1A3005	7314150286638	1	569,00	409
FF1A30NB	7314150266357	1	219,56	409
FF1A31NB	7314150266364	1	123,89	410
FF1A35	7314150264124	1	365,92	410
FF1A36	7314150265862	1	483,95	410
FF1A37	7314150265855	1	352,93	410
FF1A39	7314150266920	1	299,81	410
FF1A4001	7314150286713	1	432,70	410
FF1A4002	7314150286560	1	388,55	411
FF1A4003	7314150286706	1	316,48	411
FF1A41	7314150266982	1	138,11	411
FF1A48	7314150271801	1	371,53	411
FF1A50	7314150271825	1	529,17	411
FF1A5002	7314150286447	1	327,41	411
FF1A5003	7314150286690	1	1.033,05	412
FF1A5004	7314150286539	1	734,96	412
FF1A5005	7314150286546	1	1.019,46	412
FF1A5006	7314150286683	1	496,69	412
FF1A5007	7314150286553	1	746,21	413
FF1A5008	7314150286607	1	548,85	413
FF1A5009	7314150286669	1	484,84	413
FF1A5010	7314150286584	1	348,10	413
FF1A5011	7314150286614	1	349,69	413
FF1A5012	7314150286652	1	270,27	414
FF1A5013	7314150286577	1	538,18	414
FF1A5015	7314150307401	1	237,08	414
FF1A5017	7314150307425	1	233,63	414
FF1A5019	7314150309436	1	592,70	414
FF1A5021	7314150309467	1	293,28	414
FF1A5022	7314150309474	1	416,54	415
FF1A5023	7314150309498	1	274,87	415
FF1A5024	7314150309504	1	635,55	415
FF1A5027	7314150320684	1	770,51	415
FF1A5028	7314150320691	1	266,72	415
FF1A5029	7314150320707	1	426,76	416
FF1A5030	7314150320714	1	563,07	416
FF1A5031	7314150320721	1	343,77	416
FF1A5032	7314150320738	1	675,68	416
FF1A5036	7314150339037	1	260,79	416
FF1A5037	7314150339044	1	1.524,93	416
FF1A5038	7314150339051	1	243,07	417
FF1A51	7314150271832	1	313,73	417
FF1A53	7314150271856	1	201,57	417
FF1A54	7314150288786	1	268,99	417
FF1A55	7314150299720	1	385,27	417
FF1A56	7314150299737	1	349,69	417
FF1A65	7314150313389	1	441,57	418
FF1A66	7314150313396	1	304,88	418
FF1A67	7314150313402	1	377,86	418
FF1A68	7314150313419	1	266,72	418
FF1A70	7314150320189	1	317,46	418
FF1A71	7314150320196	1	195,60	418
FF1A72	7314150320202	1	347,03	419
FF1A82	7314150334070	1	194,78	419
FF1ASET-AUTO	7314150437993	1	3.288,79	387
FF1ASET-AUTO-M1	7314150438259	1	887,97	388
FF1ASET-AUTO-M2	7314150438327	1	1.798,86	388
FF1ASET-AUTO-M3	7314150438334	1	922,35	388
FF1ASET-AUTO-M4	7314150438341	1	1.317,64	389
FF1ASET-AUTO-M5	7314150438358	1	572,89	389
FF1ASET-AUTO-M6	7314150438365	1	1.048,38	389
FF1ASET-AUTO1	7314150254453	1	2.397,98	387
FF1ASET-AUTO2	7314150254460	1	1.694,48	388
FF1ASET-AUTO3	7314150254477	1	1.444,89	388
FF1ASET-AUTO6	7314150319909	1	1.410,55	388
FF1ASET-BASIC	7314150437368	1	901,77	387
FF1ASET-LARGE	7314150437108	1	2.068,76	386
FF1ASET-MRO2	7314150336623	1	2.833,78	387
FF1ASET-MRO3	7314150336630	1	2.044,83	387
FF1ASET-MRO4	7314150336647	1	1.375,07	387
FF1ASET-MRO5	7314150336654	1	1.096,63	387
FF1ASET-XLARGE	7314150436965	1	4.743,50	386
FF1B01LM	7314150455416	1	664,55	384
FF1B02LM	7314150455447	1	859,33	384
FF1B03LM	7314150455454	1	607,26	385
FF1B04LM	7314150455478	1	744,75	385
FF1B05LM	7314150455515	1	744,75	385
FF1B06LM	7314150455522	1	401,02	385
FF1B07LM	7314150455614	1	687,46	385
FF1B08LM	7314150455645	1	401,02	386
FF1B09LM	7314150455669	1	320,82	386
FF1B10LM	7314150455706	1	423,94	386

			€	
FF1B11LM	7314150455713	1	412,48	386
FF1BSET-MONSTER	7314150436835	1	6.868,90	384
FF1E1001	7314150285839	1	93,65	425
FF1E1002	7314150285761	1	90,10	425
FF1E1003	7314150285853	1	85,35	425
FF1E1004	7314150285754	1	94,83	425
FF1E1005	7314150285785	1	86,54	426
FF1E1006	7314150285778	1	88,90	426
FF1E1007	7314150285792	1	77,05	426
FF1E1008	7314150285822	1	91,28	426
FF1E1009	7314150285808	1	71,13	426
FF1E1009EH	7314150352579	1	51,56	433
FF1E1010	7314150285815	1	86,54	426
FF1E1011	7314150285846	1	101,95	426
FF1E1012EH	7314150352562	1	51,56	433
FF1E1013EH	7314150352586	1	91,66	433
FF1E2001	7314150285945	1	316,89	426
FF1E2002	7314150285921	1	334,28	427
FF1E2003	7314150286072	1	199,15	427
FF1E2004	7314150285952	1	210,24	427
FF1E2005	7314150285976	1	177,41	427
FF1E2006	7314150285914	1	323,54	427
FF1E2007	7314150285907	1	182,26	427
FF1E2008	7314150285860	1	189,82	428
FF1E2009EH	7314150352593	1	108,85	434
FF1E2010EH	7314150352654	1	57,29	434
FF1E2011EH	7314150373802	1	68,75	435
FF1E2101	7314150285877	1	276,19	428
FF1E2102	7314150286058	1	292,79	428
FF1E2103	7314150286089	1	353,06	428
FF1E2104	7314150285990	1	255,04	429
FF1E2105	7314150286041	1	324,81	428
FF1E2106EH	7314150352623	1	103,12	434
FF1E2107EH	7314150352661	1	74,48	434
FF1E2201	7314150286010	1	264,07	429
FF1E2202	7314150285891	1	233,29	429
FF1E2203	7314150285884	1	245,50	429
FF1E2204	7314150285983	1	193,32	429
FF1E2205	7314150285938	1	272,64	429
FF1E2206	7314150286034	1	267,90	429
FF1E2207	7314150285969	1	282,14	430
FF1E2208	7314150286027	1	163,85	430
FF1E2209	7314150286096	1	286,87	430
FF1E2210	7314150286065	1	225,23	430
FF1E2211	7314150339006	1	314,13	430
FF1E2212	7314150339013	1	124,48	430
FF1E2213	7314150339020	1	248,94	431
FF1E2214EH	7314150352647	1	229,15	434
FF1E2215EH	7314150352678	1	91,66	434
FF1E2216EH	7314150373833	1	143,22	436
FF1E2501	7314150286003	1	220,29	431
FF1E2502	7314150338993	1	94,83	431
FF1E2503EH	7314150352685	1	143,22	434
FF1E2504EH	7314150374106	1	91,66	436
FF1E2505EH	7314150373826	1	91,66	436
FF1E3001	7314150286119	1	111,86	431
FF1E3002	7314150286102	1	87,27	431
FF1E3003	7314150286157	1	119,06	432
FF1E3004	7314150286133	1	277,38	432
FF1E3005	7314150286126	1	245,38	432
FF1E3006	7314150286140	1	296,35	432
FF1E3007	7314150286164	1	92,46	432
FF1E3008	7314150286171	1	194,41	432
FF1E3009EH	7314150352722	1	85,93	434
FF1E3010EH	7314150352739	1	91,66	435
FF1E3011EH	7314150352753	1	108,85	435
FF1E4001	7314150285747	1	142,00	432
FF1E4002	7314150285730	1	101,71	432
FF1E4003EH	7314150352692	1	97,39	435
FF1E4004EH	7314150352708	1	108,85	435
FF1E4005EH	7314150352807	1	120,31	435
FF1E5001	7314150285716	1	201,34	433
FF1E5002	7314150285709	1	112,60	433
FF1E5003	7314150285723	1	106,68	433
FF1E5004	7314150338931	1	100,75	433
FF1E5005	7314150338948	1	160,04	431
FF1E5006	7314150338955	1	118,54	431
FF1E5007	7314150338962	1	171,89	432
FF1E5008	7314150338979	1	112,60	433
FF1E5009	7314150338986	1	82,98	431
FF1E5010EH	7314150352746	1	103,12	435
FF1E5011EH	7314150352777	1	97,39	435
FF1E5013EH	7314150352821	1	91,66	435
FF1E5014EH	7314150373864	1	103,12	436
FF1E5015EH	7314150373871	1	57,29	436
FF1E5016EH	7314150373888	1	28,64	436
FF1F1001	7314150286270	1	112,60	419
FF1F1002	7314150286287	1	153,96	419
FF1F1003	7314150286294	1	188,48	419
FF1F1004	7314150286263	1	139,87	419
FF1F1005	7314150286300	1	220,49	419
FF1F1006	7314150286249	1	129,22	420
FF1F1007	7314150286256	1	97,20	420
FF1F1008	7314150339129	1	130,40	420
FF1F1009	7314150339136	1	112,60	420
FF1F2001	7314150286317	1	451,72	420





FF1F2002	7314150339143	1	160,04	420
FF1F2101	7314150286331	1	560,70	420
FF1F2102	7314150339105	1	177,81	421
FF1F2103	7314150339112	1	137,49	421
FF1F2201	7314150286324	1	413,71	421
FF1F2202	7314150339150	1	183,74	421
FF1F2203	7314150339167	1	367,47	421
FF1F3001	7314150286348	1	113,62	421
FF1F3002	7314150286379	1	198,29	422
FF1F3003	7314150286409	1	264,61	422
FF1F3004	7314150286386	1	160,04	422
FF1F3005	7314150286362	1	416,08	422
FF1F3006	7314150286355	1	272,64	422
FF1F3007	7314150286393	1	178,93	422
FF1F3008	7314150286423	1	412,53	422
FF1F3009	7314150286416	1	272,64	422
FF1F3010	7314150339082	1	195,60	423
FF1F3011	7314150339099	1	201,53	423
FF1F4001	7314150286195	1	289,24	423
FF1F4002	7314150286201	1	269,09	423
FF1F4003	7314150286225	1	155,03	423
FF1F4004	7314150286232	1	193,05	423
FF1F4005	7314150286218	1	218,23	423
FF1F5001	7314150286188	1	215,25	424
FF1F5002	7314150339174	1	130,40	424
FF1F5003	7314150339181	1	189,67	424
FF1F5004	7314150339198	1	171,89	421
FF1F5005	7314150339204	1	88,90	424
FF1F5006	7314150339211	1	325,98	424
FF1F5007	7314150339228	1	201,53	424
FF1F5008	7314150339235	1	106,68	424
FF1F5009	7314150339242	1	243,02	425
FF1F5010	7314150339259	1	207,45	425
FF1F5011	7314150339266	1	910,89	425
FF1F5012	7314150339273	1	426,76	425
FF1F5013	7314150339280	1	213,11	421
FF2A07	7314150228201	1	1.004,15	444
FF2A08	7314150228225	1	447,64	444
FF2A09	7314150228249	1	517,04	445
FF2A10	7314150228263	1	551,82	445
FF2B01	7314150233441	1	971,98	445
FF2B02	7314150233465	1	729,97	445
FF2B03	7314150233489	1	796,43	445
FF2B04	7314150233502	1	450,70	446
FF2B05	7314150233526	1	743,46	446
FF2B06	7314150233540	1	107,02	446
FF2B07	7314150229420	1	958,62	446
FF2B08	7314150229451	1	447,85	446
FF2B09	7314150229482	1	532,97	446
FF2B10	7314150229505	1	496,29	447
FF2B11	7314150229529	1	123,82	447
FF2B12	7314150229543	1	1.081,98	447
FF2B13	7314150229567	1	489,81	447
FF2B14	7314150229581	1	342,44	447
FF2B15	7314150229604	1	343,35	448
FF2B16	7314150229628	1	85,23	448
FF3A01	7314150228300	1	968,17	458
FF3A02	7314150228324	1	269,26	459
FF3A03	7314150228348	1	469,09	459
FF3A04	7314150228362	1	514,40	459
FF3A05	7314150228386	1	1.071,23	459
FF3A06	7314150228416	1	286,15	459
FF3A07	7314150228430	1	467,57	460
FF3A08	7314150228454	1	371,79	460
FF3A09	7314150228478	1	1.122,25	460
FF3A10	7314150228492	1	254,58	460
FF3A11	7314150228515	1	338,31	448
FF3A12	7314150228539	1	368,33	449
FF3A13	7314150228614	1	673,95	449
FF3A14	7314150228638	1	917,32	449
FF3A15	7314150228652	1	259,59	449
FF3A16	7314150228676	1	461,17	449
FF3A17	7314150228690	1	455,08	450
FFSS-1.5-900FG	7311518275884	4	67,99	600
FGS-1.0-600	7311518123796	4	46,39	600
FGS-1.25-700	7311518123802	4	48,89	600
FGS-1.25-700-WB	7314150398720	4	51,68	600
FGS-1.6-810	7311518123819	4	55,09	600
FGS-1.6-810-WB	7314150399086	4	57,90	600
FGS-1.8-810	7311518123826	4	59,94	600
FM10	7311518010881	5	18,55	31
FM12	7314150273249	5	18,55	31
FP-3M	7311518168612	1	98,95	626
FS-5	7311518266455	10	16,31	632
FS-7.5	7311518266479	10	27,39	633
FS-8	7311518266462	10	22,20	632
G0313M03	7311518036089	1	14,52	144
G0313M03X	7311518182069	1	15,12	144
G0613M03X	7311518196592	1	30,25	144
G0618M06	7311518036119	1	31,48	144
G0618M06X	7311518036133	1	31,26	144
G0820M06	7311518036164	1	40,32	144
G0820M06X	7311518036188	1	42,34	144
G1020I06	7314150501519	5	33,66	147
G1020M06	7311518036218	1	48,79	144
G1020M06X	7311518036232	1	51,21	144



G1020S06	7314150501540	5	30,84	146
G1225I06	7314150501571	5	45,76	147
G1225M06	7311518036317	1	57,06	144
G1225M06X	7311518036331	1	59,88	144
G1225M08	7311518036362	1	60,07	144
G1225M08X	7311518188009	1	59,88	144
G1225S06	7314150501601	5	41,95	146
G1625M06	7311518192648	1	77,22	144
G1625M06X	7311518187415	1	81,05	144
G1625M08	7311518036409	1	77,22	144
G1625M08X	7311518036423	1	81,05	144
GL008-10	7314150167050	5	19,67	490
GL008-8	7314150167043	5	19,67	490
GL010-10	7314150167098	5	24,98	490
GL010-8	7314150167081	5	24,98	490
GS-180-F	7311518275488	6	28,62	632
GS-76	7311518010782	8	20,98	631
H0613M03X	7311518196615	1	31,84	145
H1020I06	7314150501717	5	57,45	147
H1025M06	7311518182304	1	56,24	145
H1025M06X	7311518182311	1	59,00	145
H1232I06	7314150501748	5	67,55	147
H1232M06	7311518182076	1	69,40	145
H1232M06X	7311518181758	1	72,80	145
H1635M06	7311518192730	1	86,60	145
H1635M06X	7311518187422	1	90,84	145
H1635M08	7311518182083	1	86,60	145
H1635M08X	7311518182090	1	95,83	145
HFGPS-0.7-400FG	7311518275877	4	45,49	600
HGPS-0.6-360	7311518123680	10	23,27	600
HGPS-0.8-380	7311518123697	4	28,45	600
HGPS-0.8-380-WB	7314150398812	4	32,95	600
HGPS-1.0-400	7311518123703	4	31,83	600
HGPS-1.0-400-WB	7314150398713	4	34,75	600
HRFM10	7311518010898	5	22,65	31
HS 7590	7314150109395	1	69,65	650
HS 7890	7314150109401	1	68,70	651
HS 7891	7314150109425	10	69,17	651
HS 7892	7314150109432	1	72,99	651
HS 7893	7314150109456	1	103,04	652
HS 8130	7314150107773	1	73,48	644
HS 8131	7314150107803	1	76,33	644
HS 8132	7314150107810	1	84,92	644
HS 8140	7314150107926	10	69,59	644
HS 8141	7314150107940	10	72,51	644
HS 8142	7314150107964	10	80,15	644
HS 8143	7314150107988	10	75,87	645
HS 8144	7314150108008	10	77,78	645
HS 8145	7314150108022	10	81,11	645
HS 8148	7314150108084	10	84,44	645
HS 8150	7314150108114	1	73,94	644
HS 8160	7314150108305	10	76,33	644
HS 8161	7314150108329	10	84,44	644
HS 8162	7314150108343	10	95,89	644
HS 8163	7314150108367	10	81,11	645
HS 8164	7314150402144	10	54,08	645
HS 8247	7314150108480	1	123,56	647
HS 8248	7314150108503	10	128,81	647
HS122M.030	7314150423293	5	208,65	653
HS6000	7314150113781	10	75,87	648
HS6001	7314150476466	10	57,30	648
HS7190	7314150475988	1	60,11	645
HS7191	7314150476473	1	60,11	645
HS7280	7314150476480	1	60,11	647
HS7285	7314150476497	1	60,11	647
HS7290	7314150476503	1	60,11	646
HS7291	7314150476510	1	69,59	646
HS7292	7314150383719	10	73,58	646
HS7293	7314150476527	1	60,11	646
HS7490	7314150350674	10	101,13	650
HS7894	7314150476534	1	89,02	652
HS8133	7314150476541	1	63,48	645
HS8134	7314150476555	1	63,48	645
HS8135	7314150476572	1	63,48	645
HS8136	7314150476589	1	63,48	645
HS8137	7314150476596	1	63,48	645
HS8138	7314150476602	1	63,48	645
HS8146	7314150425372	10	77,50	645
HS8147	7314150351954	10	77,50	645
HS8149	7314150476619	1	66,95	648
HS8151	7314150349388	10	72,10	644
HS8152	7314150476626	10	83,46	644
HS8153	7314150360055	10	89,41	645
HS8154	7314150349418	10	77,25	645
HS8155	7314150476633	1	77,25	645
HS8156	7314150476640	1	82,40	645
HS8157	7314150476657	1	82,40	645
HS8158	7314150476664	1	82,40	645
HS8165	7314150374526	10	101,34	645
HS8166	7314150476671	1	92,70	645
HS8167	7314150476688	1	92,70	645
HS8168	7314150476695	1	92,70	645
HS8211	7314150365067	10	137,11	646
HUS-0.6-380	7311518123659	4	33,53	600
HUS-0.8-500	7311518123666	4	37,50	600
HUS-1.0-650	7311518123673	4	42,20	600

			€	
IZO-D-135	7314151845827	1	745,95	105
IZO-D-200	7314151846831	1	817,83	105
IZO-D-30	7314151846824	1	745,95	105
IZO-D-340	7314151846848	1	942,40	105
IZO-DR-810	7314151846817	1	2.239,72	105
J0604M06	7311518036508	1	36,49	145
J1010M06	7311518172473	1	40,74	145
J1212M06	7311518036577	1	48,13	145
J1616M06	7311518187439	1	70,52	145
J1616M08	7311518036614	1	66,85	145
K-AP-1	7311518030117	10	31,44	632
K-GP-1	7311518030131	10	34,46	632
K0602M06	7311518036652	1	36,49	145
K1008M06	7311518036683	1	42,99	145
K1210M06	7311518036720	1	45,62	145
K1612M06	7311518193959	1	62,69	145
K1612M08	7311518036768	1	59,43	145
K172	7314150384396	1	32,66	173
K18NF-2	7314151347161	1	7,54	170
K18PH-2M5	73141503019646	1	8,37	170
K18PH-2M6	7314150274871	1	8,41	170
K19PZD-2M5	7314151693237	1	7,54	170
K19PZD-2NF	7314151586157	1	7,54	170
K20TORX-T25	7314151825799	1	10,66	170
K560F-1	7314151825492	5	3,24	173
K560F-2	7314151825324	5	3,24	174
K560F-3	7314151825331	5	3,24	174
K560F-4	7314151825348	5	3,46	178
K560F-5	7314151825355	5	3,46	178
K560F-6	7314151825362	5	3,93	181
K560F-7	7314151825379	5	4,44	183
K560F-8	7314151825508	5	5,82	183
K560F-9	7314151846688	5	6,88	185
K66100-1/4	7314150204540	1	54,27	172
K66100-1/4-1P	7314150260201	1	10,86	172
K66100-3/8	7314150204564	1	68,69	172
K66100-3/8-1P	7314150260249	1	13,74	172
K6625-1/4-1P	7314150260140	1	5,29	172
K6625-1/4B-5P	7314150533305	1	26,45	172
K6638-3/8	7314150204557	1	30,91	172
K6638-3/8-1P	7314150260164	1	6,19	172
K6650-1/2-1P	7314150260188	1	14,42	172
K6650-1/2P-5P	7314150533367	1	72,14	172
K6650-1/4B-1P	7314150533381	1	8,74	172
K6650-1/4P-5P	7314150533404	1	43,61	172
K6650-3/8-1P	7314150260225	1	11,68	172
K6650-3/8P-5P	7314150533442	1	58,40	172
K6660-QR-1P	7314150204571	1	14,15	172
K6701M-10	7314151778149	1	7,39	172
K6701M-11	7314151778224	1	7,39	172
K6701M-12	7314151811891	1	9,21	172
K6701M-13	7314151778491	1	9,21	172
K6701M-14	7314151844172	1	9,21	172
K6701M-6	7314151813260	1	7,35	172
K6701M-7	7314151777920	1	7,35	172
K6701M-8	7314151778064	1	7,39	172
K6701M-9	7314151815110	1	7,39	172
K6750-1/4	7314150204663	1	6,08	170
K6750-10-1P	7314150533466	1	6,08	170
K6750-13	7314150204823	1	6,08	170
K6750-3/8	7314150204656	1	6,08	170
K6750-6	7314150204670	1	6,08	170
K6750-7	7314150204687	1	6,08	170
K6964C	7314151215170	1	23,20	174
K7401M-10	7314151780128	1	8,70	173
K7401M-11	7314151780395	1	8,70	173
K7401M-12	7314151811907	1	8,70	173
K7401M-13	7314151780470	1	8,70	173
K7401M-14	7314151780555	1	8,70	173
K7401M-15	7314151812140	1	8,70	173
K7401M-16	7314151780630	1	8,70	173
K7401M-17	7314151780715	1	8,70	173
K7401M-18	7314151812157	1	10,34	173
K7401M-19	7314151812164	1	10,34	173
K7401M-20	7314151844271	1	10,63	173
K7401M-21	7314151845216	1	10,63	173
K7401M-22	7314151845223	1	11,12	173
K7401M-24	7314151844295	1	11,29	173
K7401M-7	7314151812126	1	8,70	173
K7401M-8	7314151780043	1	8,70	173
K7401M-9	7314151812133	1	8,70	173
K7401M/10	7314150389919	1	86,46	174
K7401TORX-E-S7	7314150343324	1	79,96	175
K7401TORX-E10	7314151844448	1	11,42	174
K7401TORX-E12	7314151844455	1	11,42	174
K7401TORX-E14	7314151844462	1	11,42	174
K7401TORX-E5	7314151844400	1	11,42	174
K7401TORX-E6	7314151844417	1	11,42	174
K7401TORX-E7	7314151844424	1	11,42	174
K7401TORX-E8	7314151844431	1	11,42	174
K7401Z-1/2	7314150384402	1	9,17	173
K7401Z-11/16	7314150384419	1	9,17	173
K7401Z-13/16	7314150384426	1	9,17	173
K7401Z-3/4	7314150384433	1	9,17	173
K7401Z-3/8	7314150384440	1	9,17	173
K7401Z-5/8	7314150384457	1	9,17	173

			€	
K7401Z-7/16	7314150384464	1	9,17	173
K7401Z-7/8	7314150384471	1	9,17	173
K7401Z-9/16	7314150384488	1	9,17	173
K7406M-10	7314151844479	1	9,73	173
K7406M-13	7314151844486	1	11,05	173
K7406M-17	7314151844493	1	12,05	173
K7760C-1	7314151222369	1	16,02	174
K7760C-2	7314151222376	1	23,03	174
K7764D	7314151222475	1	24,02	177
K7767S	7314151222512	1	33,88	174
K7800M-10	7314150326297	1	6,35	175
K7800M-11	7314150326303	1	6,35	175
K7800M-12	7314150326310	1	6,35	175
K7800M-13	7314150326327	1	6,35	175
K7800M-14	7314150326334	1	6,46	175
K7800M-15	7314150326341	1	6,46	175
K7800M-16	7314150326358	1	6,46	175
K7800M-17	7314150326365	1	6,75	175
K7800M-18	7314150326372	1	6,75	175
K7800M-19	7314150326389	1	6,75	175
K7800M-21	7314150326396	1	6,75	175
K7800M-22	7314150326402	1	6,86	175
K7800M-24	7314150326419	1	7,42	175
K7800M/13	7314150437221	1	81,34	178
K7801M-10	7314151778576	1	10,29	175
K7801M-11	7314151778651	1	10,29	175
K7801M-12	7314151815790	1	10,29	175
K7801M-13	7314151778736	1	10,29	175
K7801M-14	7314151778811	1	10,65	175
K7801M-15	7314151815806	1	10,86	175
K7801M-16	7314151779030	1	10,86	175
K7801M-17	7314151779115	1	11,37	175
K7801M-18	7314151779382	1	11,37	175
K7801M-19	7314151779467	1	11,37	175
K7801M-20	7314151844509	1	11,99	175
K7801M-21	7314151779542	1	12,06	175
K7801M-22	7314151779627	1	12,20	175
K7801M-23	7314151844516	1	12,57	175
K7801M-24	7314151779894	1	12,76	175
K7801M-25	7314151844523	1	14,77	175
K7801M-26	7314151844530	1	15,18	175
K7801M-27	7314151779979	1	15,18	175
K7801M-28	7314150430154	1	15,18	175
K7801M-29	7314150430161	1	15,34	175
K7801M-30	7314151811914	1	18,60	175
K7801M-32	7314151825157	15	26,64	175
K7801M-34	7314151844547	1	30,09	175
K7801M-36	7314151844554	1	31,10	175
K7801M-8	7314151845230	1	6,08	175
K7801M-9	7314151845247	1	6,08	175
K7801TORX-E10	7314151811587	1	13,63	177
K7801TORX-E12	7314151811594	1	13,63	177
K7801TORX-E14	7314151811600	1	13,63	177
K7801TORX-E16	7314151811617	1	13,63	177
K7801TORX-E18	7314151811624	1	13,63	177
K7801TORX-E20	7314151811631	1	14,77	177
K7801TORX-E24	7314151811648	1	14,77	177
K7801VM-17	7314151781521	1	12,96	176
K7801VM-19	7314151781798	1	12,96	176
K7801VM-22	7314151781873	1	13,82	176
K7801VM-24	7314151781958	1	14,17	176
K7801VM/S4	7314151799090	1	61,36	178
K7801Z-1	7314151844639	1	13,35	176
K7801Z-1.1/16	7314151844646	1	14,45	176
K7801Z-1.1/2	7314150137701	5	34,36	176
K7801Z-1.1/4	7314151844660	1	25,73	176
K7801Z-1.1/8	7314151844653	1	15,37	176
K7801Z-1.3/8	7314150137688	5	29,88	176
K7801Z-1.5/16	7314150137671	5	29,88	176
K7801Z-1.7/16	7314150137695	5	29,88	176
K7801Z-1/2	7314151822620	1	10,36	176
K7801Z-11/16	7314151844592	1	10,73	176
K7801Z-13/16	7314151844608	1	10,89	176
K7801Z-15/16	7314151844622	1	12,78	176
K7801Z-3/4	7314151822668	1	10,74	176
K7801Z-3/8	7314151822606	1	10,36	176
K7801Z-5/8	7314151844585	1	10,73	176
K7801Z-7/16	7314151844561	1	10,36	176
K7801Z-7/8	7314151844615	1	10,89	176
K7801Z-9/16	7314151822637	1	10,73	176
K7801Z/10	7314150165018	1	113,44	178
K7806M-10	7314151844677	1	12,54	175
K7806M-11	7314151844684	1	12,54	175
K7806M-12	7314151844691	1	12,54	175
K7806M-13	7314151805944	1	12,54	175
K7806M-14	7314151844707	1	12,54	175
K7806M-15	7314150330683	1	12,68	175
K7806M-16	7314151844714	1	12,68	175
K7806M-17	7314151805951	1	12,68	175
K7806M-18	7314151844721	1	12,72	175
K7806M-19	7314151805968	1	12,72	175
K7806M-21	7314151823597	1	12,72	175
K7806M-22	7314151805975	1	12,72	175
K7806M-23	7314151844738	1	13,31	175
K7806M-24	7314151805982	1	13,13	175
K7806M-27	7314151805999	1	15,32	175



K7806M-30



K7806M-30	7314151844578	1	17,32	175
K7806M-32	7314150220304	1	20,23	175
K7806M-36	7314150220311	1	23,42	175
K7806M/S4	7314151813222	1	51,24	178
K7806Z-1	7314150137817	5	15,77	176
K7806Z-1.1/16	7314150137824	5	16,84	176
K7806Z-1.1/2	7314150137886	5	39,35	176
K7806Z-1.1/4	7314150137848	5	29,48	176
K7806Z-1.1/8	7314150137831	5	19,06	176
K7806Z-1.3/8	7314150137862	5	34,24	176
K7806Z-1.5/16	7314150137855	5	34,24	176
K7806Z-1.7/16	7314150137879	5	34,24	176
K7806Z-1/2	7314150137749	10	13,78	176
K7806Z-11/16	7314150137770	5	13,94	176
K7806Z-13/16	7314150137794	5	13,98	176
K7806Z-15/16	7314150137718	5	14,43	176
K7806Z-3/4	7314150137787	5	13,98	176
K7806Z-3/8	7314150137725	10	13,78	176
K7806Z-5/8	7314150137763	5	13,94	176
K7806Z-7/16	7314150137732	5	13,78	176
K7806Z-7/8	7314150137800	5	13,98	176
K7806Z-9/16	7314150137756	10	13,78	176
K7806Z/10	7314150165025	1	141,37	178
K8160D-1	7314151237400	1	14,10	177
K8160D-2	7314151237417	1	17,36	177
K8160D-3	7314151237424	1	27,51	177
K8164C	7314151237523	1	23,20	174
K8164F	7314151237554	1	33,68	180
K8167S	7314151237592	1	34,64	177
K8901M-17	7314151803155	1	23,17	179
K8901M-18	7314151844189	1	23,15	179
K8901M-19	7314151803162	1	23,17	179
K8901M-21	7314151803179	1	23,26	179
K8901M-22	7314151803186	1	23,26	179
K8901M-23	7314151803193	1	23,26	179
K8901M-24	7314151803209	1	24,15	179
K8901M-27	7314151803216	1	25,49	179
K8901M-28	7314151803223	1	26,66	179
K8901M-29	7314151803230	1	29,88	179
K8901M-30	7314151803247	1	32,66	179
K8901M-32	7314151803254	1	32,56	179
K8901M-33	7314151803261	1	33,39	179
K8901M-34	7314151803278	1	33,36	179
K8901M-36	7314151803285	1	35,18	179
K8901M-38	7314151803292	1	36,73	179
K8901M-41	7314151803308	1	43,67	179
K8901M-46	7314151803315	1	44,35	179
K8901M-50	7314151846398	1	72,67	179
K8901M-55	7314151846404	1	87,58	179
K8901M-60	7314151846411	1	102,80	179
K8901M/8	7314150165032	1	238,09	181
K8901Z-1	7314151844752	1	29,07	180
K8901Z-1.1/16	7314151844769	1	29,07	180
K8901Z-1.1/2	7314151844820	1	39,18	180
K8901Z-1.1/4	7314151844783	1	29,77	180
K8901Z-1.1/8	7314151844776	1	29,07	180
K8901Z-1.11/16	7314150130269	1	46,90	180
K8901Z-1.13/16	7314150130276	1	46,35	180
K8901Z-1.15/16	7314150130290	1	65,79	180
K8901Z-1.3/16	7314150130245	1	29,07	180
K8901Z-1.3/4	7314151844844	1	51,41	180
K8901Z-1.3/8	7314151844806	1	30,56	180
K8901Z-1.5/16	7314151844790	1	29,77	180
K8901Z-1.5/8	7314151844837	1	43,20	180
K8901Z-1.7/16	7314151844813	1	30,56	180
K8901Z-1.7/8	7314150130283	1	59,51	180
K8901Z-1.9/16	7314150130252	1	36,74	180
K8901Z-11/16	7314150130238	1	27,79	180
K8901Z-13/16	7314151844226	1	27,79	180
K8901Z-15/16	7314151844745	1	27,79	180
K8901Z-2	7314150130306	1	65,79	180
K8901Z-2.1/16	7314150130313	1	74,57	180
K8901Z-2.1/4	7314150130344	1	86,61	180
K8901Z-2.3/16	7314150130337	1	82,60	180
K8901Z-2.3/8	7314150130351	1	93,07	180
K8901Z-3/4	7314151844202	1	27,79	180
K8901Z-7/8	7314151844301	1	27,79	180
K8901Z/18	7314150436514	1	516,55	181
K8901Z/8	7314150165049	1	247,09	181
K8906M-17	7314151803056	1	42,73	179
K8906M-19	7314151803063	1	43,71	179
K8906M-21	7314151844851	1	44,43	179
K8906M-22	7314151803070	1	44,43	179
K8906M-24	7314151803087	1	45,14	179
K8906M-27	7314151803094	1	46,84	179
K8906M-30	7314151803117	1	47,83	179
K8906M-32	7314151803124	1	50,94	179
K8906M-33	7314151844868	1	51,67	179
K8906M-34	7314151844875	1	54,42	179
K8906M-36	7314151803148	1	56,30	179
K8906M-41	7314151845254	1	58,73	179
K8906M-42	7314150512607	1	42,69	179
K8906M-46	7314150220601	1	67,58	179
K8906M/8	7314150165056	1	370,28	181
K8906Z-1	7314150130436	1	46,69	180
K8906Z-1.1/16	7314150130443	1	46,69	180



K8906Z-1.1/2	7314150130511	1	57,73	180
K8906Z-1.1/4	7314150130474	1	48,55	180
K8906Z-1.1/8	7314150130450	1	46,69	180
K8906Z-1.3/4	7314150130559	1	69,94	180
K8906Z-1.3/8	7314150130498	1	56,00	180
K8906Z-1.5/16	7314150130481	1	55,47	180
K8906Z-1.5/8	7314150130535	1	57,73	180
K8906Z-1.7/16	7314150130504	1	56,00	180
K8906Z-13/16	7314150130405	1	46,69	180
K8906Z-15/16	7314150130429	1	46,69	180
K8906Z-2	7314150130580	1	105,65	180
K8906Z-3/4	7314150130399	1	46,69	180
K8906Z-7/8	7314150130412	1	46,69	180
K8906Z/8	7314150165063	1	413,80	181
K8909H-5	7314151619343	1	60,95	180
K8909ML-12	7314151232863	1	18,29	183
K8909ML-14	7314151232870	1	18,29	183
K8909ML-17	7314151232887	1	18,29	183
K8960F-2	7314151268138	1	45,94	181
K8960F-3	7314151268145	1	55,15	181
K8960F-4	7314150220625	1	59,76	181
K8964D	7314151268237	1	16,59	177
K8964G	7314151268268	1	35,75	182
K8967S	7314151268329	1	92,02	180
K9501M-22	7314151844882	1	43,37	182
K9501M-24	7314151802677	1	43,37	182
K9501M-27	7314151802684	1	44,73	182
K9501M-30	7314151802714	1	45,96	182
K9501M-32	7314151802721	1	48,26	182
K9501M-33	7314151802738	1	49,64	182
K9501M-34	7314151802745	1	51,18	182
K9501M-36	7314151802752	1	51,18	182
K9501M-38	7314151802769	1	51,58	182
K9501M-41	7314151802776	1	58,12	182
K9501M-42	7314151802783	1	68,47	182
K9501M-46	7314151802790	1	71,48	182
K9501M-50	7314151802806	1	79,66	182
K9501M-55	7314151802813	1	91,20	182
K9501M-60	7314151802820	1	111,09	182
K9501M-65	7314151802837	1	132,93	182
K9501M-70	7314151802844	1	151,57	182
K9501M-75	7314151802851	1	158,49	182
K9501M-80	7314151802868	1	166,83	182
K9501M-85	7314150352197	1	261,98	182
K9501Z-1	7314151844912	1	43,82	182
K9501Z-1.1/16	7314150130634	1	43,82	182
K9501Z-1.1/2	7314151844943	1	55,91	182
K9501Z-1.1/4	7314151844929	1	43,82	182
K9501Z-1.1/8	7314150130641	1	43,82	182
K9501Z-1.11/16	7314150130696	1	68,79	182
K9501Z-1.13/16	7314151844967	1	74,85	182
K9501Z-1.15/16	7314150130719	1	77,53	182
K9501Z-1.3/16	7314150130658	1	43,82	182
K9501Z-1.3/4	7314150130702	1	68,79	182
K9501Z-1.3/8	7314150130672	1	54,56	182
K9501Z-1.5/16	7314150130665	1	48,74	182
K9501Z-1.5/8	7314151844950	1	59,82	182
K9501Z-1.7/16	7314151844936	1	54,56	182
K9501Z-1.7/8	7314151844974	1	74,85	182
K9501Z-1.9/16	7314150130689	1	55,91	182
K9501Z-2	7314150130726	1	87,70	182
K9501Z-2.1/4	7314150130764	1	107,05	182
K9501Z-2.1/8	7314150130740	1	98,54	182
K9501Z-2.3/16	7314150130757	1	98,54	182
K9501Z-2.3/4	7314150130832	1	155,07	182
K9501Z-2.5/16	7314150130771	1	107,05	182
K9501Z-2.9/16	7314150130801	1	147,64	182
K9506M-22	7314151844998	1	72,10	182
K9506M-24	7314151802530	1	72,10	182
K9506M-27	7314151802547	1	72,10	182
K9506M-30	7314151802554	1	72,81	182
K9506M-32	7314151802561	1	74,83	182
K9506M-33	7314151802578	1	75,85	182
K9506M-34	7314151845018	1	77,86	182
K9506M-36	7314151802585	1	77,86	182
K9506M-38	7314151802592	1	79,33	182
K9506M-41	7314151802608	1	87,57	182
K9506M-46	7314151802615	1	95,25	182
K9506M-50	7314151802622	1	115,77	182
K9506M-55	7314151802639	1	140,96	182
K9506M-60	7314151802646	1	172,26	182
K9506Z-1	7314150131686	1	64,50	182
K9506Z-1.1/16	7314150131693	1	65,52	182
K9506Z-1.1/2	7314150131761	1	67,93	182
K9506Z-1.1/4	7314150131723	1	65,73	182
K9506Z-1.13/16	7314150131808	1	94,12	182
K9506Z-1.3/16	7314150131716	1	65,52	182
K9506Z-1.5/8	7314150131785	1	73,42	182
K9506Z-1.7/16	7314150131754	1	65,73	182
K9506Z-1.7/8	7314150131815	1	106,15	182
K9509H5	7314151619428	1	97,16	182
K9509ML-19	7314151618964	1	18,77	183
K9509ML-22	7314151619183	1	24,61	183
K9509ML-24	7314151619268	1	24,68	183
K9560G-0	7314150240012	1	55,47	180
K9560G-1	7314151285944	1	60,57	183



K9560G-2	7314151285951	1	66,26	183
K9560G-3	7314151285968	1	77,33	183
K9560G-4	7314150133970	1	66,49	183
K9560G-5	7314150133987	1	81,26	183
K9564F	7314151286026	1	37,34	180
K9567S	7314151286095	1	193,31	183
K9598H	7314150133956	1	274,25	184
K9801M-100	7314151845162	1	538,35	183
K9801M-105	7314151845179	1	582,87	183
K9801M-110	7314151845186	1	736,18	183
K9801M-115	7314151845193	1	776,42	183
K9801M-120	7314151845209	1	835,88	183
K9801M-125	7314150167159	1	862,83	183
K9801M-130	7314150167166	1	958,70	183
K9801M-135	7314150167173	1	1.054,56	183
K9801M-140	7314150167180	1	1.102,50	183
K9801M-145	7314150167197	1	1.214,35	183
K9801M-150	7314150167203	1	1.438,07	183
K9801M-155	7314150167210	1	1.629,79	183
K9801M-46	7314151845056	1	202,35	183
K9801M-50	7314151845063	1	202,35	183
K9801M-55	7314151845070	1	214,30	183
K9801M-60	7314151845087	1	237,97	183
K9801M-65	7314151845094	1	258,86	183
K9801M-70	7314151845100	1	279,56	183
K9801M-75	7314151845117	1	303,32	183
K9801M-80	7314151845124	1	332,98	183
K9801M-85	7314151845131	1	382,60	183
K9801M-90	7314151845148	1	424,22	183
K9801M-95	7314151845155	1	501,30	183
K9801Z-1.1/2	7314150131976	1	128,37	184
K9801Z-1.11/16	7314150132003	1	131,16	184
K9801Z-1.13/16	7314150132027	1	138,13	184
K9801Z-1.15/16	7314150132041	1	138,13	184
K9801Z-1.3/4	7314150132010	1	138,13	184
K9801Z-1.3/8	7314150131952	1	128,77	184
K9801Z-1.5/8	7314150131990	1	131,16	184
K9801Z-1.7/16	7314150131969	1	128,37	184
K9801Z-1.7/8	7314150132034	1	138,13	184
K9801Z-1.9/16	7314150131983	1	132,47	184
K9801Z-2	7314150132058	1	138,13	184
K9801Z-2.1/16	7314150132065	1	139,48	184
K9801Z-2.1/2	7314150132133	1	190,50	184
K9801Z-2.1/4	7314150132096	1	159,38	184
K9801Z-2.1/8	7314150132072	1	141,17	184
K9801Z-2.11/16	7314150132164	1	220,06	184
K9801Z-2.13/16	7314150132188	1	207,44	184
K9801Z-2.15/16	7314150132201	1	280,05	184
K9801Z-2.3/16	7314150132089	1	143,52	184
K9801Z-2.3/4	7314150132171	1	240,84	184
K9801Z-2.3/8	7314150132119	1	189,35	184
K9801Z-2.5/16	7314150132102	1	172,48	184
K9801Z-2.5/8	7314150132157	1	206,31	184
K9801Z-2.7/16	7314150132126	1	191,23	184
K9801Z-2.7/8	7314150132195	1	262,74	184
K9801Z-2.9/16	7314150132140	1	199,22	184
K9801Z-3	7314150132218	1	294,34	184
K9801Z-3.1/16	7314150132225	1	320,74	184
K9801Z-3.1/2	7314150132287	1	371,58	184
K9801Z-3.1/4	7314150132249	1	333,84	184
K9801Z-3.1/8	7314150132232	1	336,92	184
K9801Z-3.11/16	7314150132317	1	571,16	184
K9801Z-3.13/16	7314150132331	1	555,51	184
K9801Z-3.15/16	7314150132355	1	656,12	184
K9801Z-3.3/4	7314150132324	1	558,46	184
K9801Z-3.3/8	7314150132263	1	356,48	184
K9801Z-3.5/16	7314150132256	1	343,27	184
K9801Z-3.5/8	7314150132300	1	487,78	184
K9801Z-3.7/16	7314150132270	1	367,93	184
K9801Z-3.7/8	7314150132348	1	655,38	184
K9801Z-3.9/16	7314150132294	1	416,92	184
K9801Z-4	7314150132362	1	664,99	184
K9801Z-4.1/16	7314150132379	1	672,76	184
K9801Z-4.1/2	7314150132430	1	843,93	184
K9801Z-4.1/4	7314150132393	1	714,11	184
K9801Z-4.1/8	7314150132386	1	698,42	184
K9801Z-4.3/4	7314150132454	1	1.034,29	184
K9801Z-4.3/8	7314150132416	1	805,87	184
K9801Z-4.5/16	7314150132409	1	760,26	184
K9801Z-4.5/8	7314150132447	1	863,30	184
K9801Z-4.7/16	7314150132423	1	824,49	184
K9806M-100	7314150131105	1	973,39	183
K9806M-105	7314150131112	1	1.069,91	183
K9806M-110	7314150131129	1	1.366,00	183
K9806M-115	7314150131136	1	1.521,45	183
K9806M-120	7314150131143	1	2.921,82	183
K9806M-41	7314150130986	1	413,41	183
K9806M-46	7314150130993	1	413,41	183
K9806M-50	7314150131006	1	413,41	183
K9806M-55	7314150131013	1	413,41	183
K9806M-60	7314150131020	1	423,37	183
K9806M-65	7314150131037	1	469,53	183
K9806M-70	7314150131044	1	527,92	183
K9806M-75	7314150131051	1	590,42	183
K9806M-80	7314150131068	1	714,10	183
K9806M-85	7314150131075	1	718,54	183



K9806M-90	7314150131082	1	758,76	183
K9806M-95	7314150131099	1	893,22	183
K9806Z-1.1/2	7314150131174	1	191,80	184
K9806Z-1.11/16	7314150131198	1	193,68	184
K9806Z-1.3/8	7314150131150	1	192,23	184
K9806Z-1.5/8	7314150131181	1	193,68	184
K9806Z-1.7/16	7314150131167	1	193,68	184
K9806Z-2	7314150131204	1	203,04	184
K9806Z-2.1/16	7314150131211	1	203,04	184
K9806Z-2.1/2	7314150131273	1	285,95	184
K9806Z-2.1/4	7314150131235	1	228,69	184
K9806Z-2.11/16	7314150131303	1	353,53	184
K9806Z-2.13/16	7314150131327	1	385,78	184
K9806Z-2.15/16	7314150131341	1	412,67	184
K9806Z-2.3/16	7314150131228	1	219,94	184
K9806Z-2.3/4	7314150131310	1	369,05	184
K9806Z-2.3/8	7314150131259	1	280,84	184
K9806Z-2.5/16	7314150131242	1	233,61	184
K9806Z-2.5/8	7314150131297	1	347,52	184
K9806Z-2.7/16	7314150131266	1	281,96	184
K9806Z-2.7/8	7314150131334	1	407,54	184
K9806Z-2.9/16	7314150131280	1	287,56	184
K9806Z-3	7314150131358	1	443,87	184
K9806Z-3.1/16	7314150131365	1	466,96	184
K9806Z-3.1/2	7314150131433	1	569,51	184
K9806Z-3.1/4	7314150131396	1	526,10	184
K9806Z-3.1/8	7314150131372	1	490,65	184
K9806Z-3.11/16	7314150131464	1	759,13	184
K9806Z-3.13/16	7314150131488	1	759,13	184
K9806Z-3.15/16	7314150131501	1	819,72	184
K9806Z-3.3/16	7314150131389	1	499,06	184
K9806Z-3.3/4	7314150131471	1	780,76	184
K9806Z-3.3/8	7314150131419	1	546,32	184
K9806Z-3.5/16	7314150131402	1	526,14	184
K9806Z-3.5/8	7314150131457	1	598,68	184
K9806Z-3.7/16	7314150131426	1	569,51	184
K9806Z-3.7/8	7314150131495	1	841,26	184
K9806Z-3.9/16	7314150131440	1	607,91	184
K9806Z-4	7314150131518	1	828,55	184
K9806Z-4.1/16	7314150131525	1	808,33	184
K9806Z-4.1/2	7314150131570	1	1.300,33	184
K9806Z-4.1/4	7314150131549	1	1.047,80	184
K9806Z-4.1/8	7314150131532	1	1.014,18	184
K9806Z-4.3/4	7314150131594	1	1.422,03	184
K9806Z-4.3/8	7314150131563	1	1.256,31	184
K9806Z-4.5/16	7314150131556	1	1.165,07	184
K9806Z-4.5/8	7314150131587	1	1.332,66	184
K9860H-1	7314150133994	1	416,85	184
K9860H-2	7314150134007	1	459,82	184
K9860H-3	7314150134014	1	463,86	184
K9867S	7314150133932	1	654,43	184
K9895G	7314150133949	1	175,52	183
K9899H	7314150166763	1	1.222,34	185
K9998H	7314150133963	1	932,29	185
KB09-01	7314150196968	5	8,58	581
KB18-01	7314150196944	5	10,87	581
KBFU-01	7314150196913	5	16,21	580
KBGH-5P-DISPEN	7314150296729	20	3,42	581
KBGR-5P-DISPEN	7314150296774	20	4,69	581
KBGU-100P	7314150213405	1	32,60	581
KBGU-10P-DISPEN	7314150262984	20	5,05	581
KBGU-5P-DISPEN	7314150296705	20	2,93	581
KBRU-01	7314150196876	5	18,01	580
KBSK-01	7314150196999	5	20,01	583
KBSU-01	7314150197002	5	20,01	583
KBTU-01	7314150196982	5	31,44	583
KBWS-01	7314150225972	10	6,02	586
KCB753	7314150204915	1	46,16	171
KE18-01	7314150196937	5	16,00	580
KEFU-01	7314150196906	5	18,77	580
KERU-01	7314150196869	5	20,87	580
KG09-01	7314150196975	5	6,15	581
KG09-01-3P	7314150213962	10	18,44	581
KG18-01	7314150196951	5	7,99	582
KGAU-01	7314150223893	5	16,40	582
KGFU-01	7314150196920	5	11,57	580
KGRU-01	7314150196883	5	12,85	580
KGRU-02	7314150196890	5	11,43	580
KGSU-01	7314150197019	5	15,43	583
KHU-01	7314150268955	4	4,82	582
KM1/4-5/16-1P	7314150275953	1	6,79	172
KM653-1P	7314151840709	1	6,00	171
KM653-5P	7314150533565	1	30,02	171
KM653-QR-1P	7314151848507	1	15,31	170
KM653-QR-5P	7314150533589	1	65,95	170
KM653-SF	7314150204984	1	17,87	171
KM6701M-10	7314151844264	1	32,96	173
KM6701M-7	7314151844240	1	31,56	173
KM6701M-8	7314151844257	1	31,95	173
KM6750-1/4	7314150204595	1	7,41	170
KM6750-10-1P	7314150533626	1	7,41	170
KM6750-11	7314150302628	1	7,41	170
KM6750-13-1P	7314150533664	1	7,41	170
KM6750-3/8	7314150204588	1	7,41	170
KM6750-6	7314150204601	1	7,41	170
KM6750-7	7314150204618	1	7,41	170



KM753-QR-1P



KM753-QR-1P	7314150204830	1	17,17	171
KMR150	7314150204960	1	68,69	171
KMR150-1P	7314150204977	1	15,79	171
KMR653-5P	7314150533763	1	25,93	171
KMR653-1P	7314150204939	1	8,99	171
KMR753	7314150204946	1	41,22	171
KMR753-1P	7314150204953	1	8,23	171
KMT753-QR-1P	7314150391523	1	10,23	171
KMU-01	7314150197026	5	8,58	580
KR653	7314150204885	1	29,19	171
KR653-1P	7314150260263	1	5,84	171
KRSS-01	7314150214938	10	6,71	586
KS7401M-10	7314150384495	1	33,54	174
KS7401M-11	7314150384501	1	33,54	174
KS7401M-12	7314150384518	1	33,54	174
KS7401M-13	7314150384525	1	33,54	174
KS7401M-14	7314150384532	1	34,67	174
KS7401M-15	7314150384549	1	34,67	174
KS7401M-16	7314150384556	1	34,67	174
KS7401M-17	7314150384563	1	34,67	174
KS7401M-18	7314150384570	1	34,67	174
KS7401M-19	7314150384587	1	34,67	174
KS7401M-22	7314150384594	1	37,42	174
KS7401M-9	7314150384600	1	33,54	174
KSBG09-10DISPEN	7314150262991	20	4,50	582
KSBG18-10DISPEN	7314150263004	20	5,88	582
KSR753	7314150204892	1	99,03	529
KSR753-1P	7314150204908	1	21,92	529
KUBG09-5P	7314150213450	20	3,05	582
KUBG18-5DISPEN	7314150296835	20	4,19	582
L1020I06	7314150501649	5	40,32	147
L1020M06	7311518133665	1	58,22	145
L1020M06X	7311518136369	1	61,14	145
L1020S06	7314150501670	5	36,98	147
L1225M06	7311518132774	1	64,73	145
L1225M06X	7311518136857	1	71,65	145
L1228I06	7314150501700	5	49,26	147
L1228S06	7314150501731	5	45,15	147
L1230AL06	7311518187668	1	87,76	146
L1230AL08	7311518181871	1	87,76	146
L1230M06	7311518182168	1	73,22	145
L1230M06X	7311518182175	1	72,80	145
L1630M06	7311518192914	1	76,59	145
L1630M06X	7311518187446	1	80,38	145
L1630M08	7311518182205	1	76,59	145
L1630M08X	7311518136833	1	80,38	145
LAP-KNIFE	7311518216443	10	41,50	635
LARGE	7314150437429	1	2.652,25	375
LS-6160-23	7311518041304	90	8,94	637
LS-COIN 19 CM	7311518031077	4	29,31	601
LS-COIN 26 CM	7311518333041	2	31,49	601
LS-COMBINESS	7311518041366	600	12,94	636
LS-MASSE-4	7311518012014	2	46,54	600
LS-MASSE-4FG	7311518275891	2	57,46	600
LS-MASSE-TR-4FG	7311518281106	2	63,18	601
LS-MERLIN-2.5	7311518012069	2	49,31	601
LS-MERLIN-2.5FG	7311518281113	2	63,65	601
LS-PIERRE CORINDON	7311518009977	1	15,43	636
LS-PIERRE-FAUX	7311518009038	90	16,39	637
LT-STEEL-30	7314150138012	5	67,31	539
LT-STEEL-50	7314150138029	5	105,38	539
LTB-10	7314150120048	6	19,94	539
LTB-20	7314150120062	6	22,62	539
LTB-30	7314150120086	6	29,24	539
LTG-10	7314150119981	6	16,70	539
LTG-20	7314150120000	6	22,38	539
LTG-30	7314150120024	6	26,83	539
LTS-100	7314150120147	5	82,18	539
LTS-100-E	7314150120154	5	82,18	539
LTS-30	7314150120109	5	28,27	539
LTS-30-E	7314150120116	5	28,27	539
LTS-50	7314150120123	5	38,96	539
LTS-50-E	7314150120130	5	38,96	539
LUB-2015	7311518335427	6	19,96	637
M0310M03	7311518036805	1	19,78	145
M0310M03X	7311518197063	1	19,76	145
M0613M03X	7311518196622	1	30,25	145
M0618M06	7311518036836	1	34,67	145
M0618M06X	7311518036850	1	34,48	145
M1022M06	7311518036881	1	41,91	145
M1022M06X	7311518036904	1	41,74	145
M1227M06	7311518036928	1	53,82	145
M1227M06X	7311518036959	1	53,63	145
M1227M08	7311518036980	1	53,71	145
M1630M06	7311518193010	1	88,91	145
M1630M06X	7311518187453	1	88,51	145
M1630M08	7311518037062	1	88,91	145
M1630M08X	7311518037086	1	88,51	145
M227L	7311518160883	4	36,92	577
M227R	7311518160869	4	36,92	578
M330	7311518160906	4	72,01	578
M526	7311518160982	4	37,32	578
M6376	7311518196486	1	293,24	578
M6376-SH	7311518199296	1	125,67	578
M676	7311518161088	1	283,73	578
M676-SH	7311518211875	1	125,44	578



M780	7314151826215	1	20,42	219
M781	7314153016218	5	12,91	219
M926	7311518161071	1	82,93	579
M926-SH	7314150107537	1	18,33	579
MA225	7311518161057	4	48,99	576
MA225L	7311518161033	4	51,01	576
MA225R	7311518161040	4	51,01	576
MA311	7314150181568	1	38,66	576
MA321	7314150181551	10	38,66	576
MA325	7311518161064	4	58,76	577
MA351	7314150181582	10	43,30	577
MA361	7314150181575	10	43,30	577
MA401	7314150167593	10	29,61	576
MA411	7314150167609	10	29,61	576
MA421	7314150167616	10	29,61	576
MA431	7314150181544	1	32,48	576
MA500-1A	7314150458882	1	273,26	654
MA500-2A	7314150458899	1	279,60	654
MA500-3A	7314150456925	1	285,74	654
MAM50M	7314150215300	1	248,76	115
MCP-2.5-810	7311518124052	2	73,40	600
MES-3.0-900	7311518123864	2	53,78	601
MES-3.5-900	7311518123871	2	59,98	601
MES-3.5-900FG	7311518281120	2	77,08	601
MK5	7314150224333	1	27,48	59
MK9	7314150224326	1	41,89	60
MONSTER	7314150437405	1	8.249,56	375
MR227L	7311518161002	4	45,96	578
MR227R	7311518160999	4	45,55	578
MR340	7311518197537	2	92,78	577
MT-TS-3	7314150194995	12	9,85	538
MTB-3-16	7314150119066	6	11,76	538
MTB-3-16-M	7314150119073	6	13,41	538
MTB-3-16-M-E	7314150119141	6	13,41	538
MTB-5-25	7314150119080	6	24,03	538
MTB-5-25-C1	7314150119127	6	35,59	538
MTB-5-25-M	7314150119097	6	25,71	538
MTB-5-25-M-E	7314150119158	6	25,71	538
MTB-8-25	7314150125418	6	36,58	538
MTB-8-25-M	7314150127078	6	39,01	538
MTB-8-25-M-E	7314150127085	6	39,01	538
MTC-3-13	7314150321322	6	8,15	538
MTC-3-13-C1	7314150330843	6	11,34	538
MTC-5-16	7314150321339	6	9,93	538
MTC-5-16-C1	7314150330850	6	12,71	538
MTG-3-16	7314150118984	12	5,26	538
MTG-3-16-E	7314150119028	12	5,26	538
MTG-5-19	7314150118991	12	8,28	538
MTG-5-19-E	7314150119035	12	8,28	538
MTG-8-25	7314150330348	4	10,53	538
MTG-8-25-E	7314150390809	4	10,53	538
MTS-5-25	7314150119233	6	32,49	538
MTS-5-25-E	7314150119271	6	32,49	538
MTS-8-25	7314150119257	6	40,13	538
MTS-8-25-E	7314150119295	6	40,13	538
MTT051	7314150270521	6	25,13	586
MTT121	7314150213290	8	20,51	586
MTT151	7314150120703	6	42,10	586
MW-150	7314150125685	2	76,06	539
MW-250	7314150125678	2	136,43	539
N0306M03	7311518182212	1	19,03	145
N0306M03E	7311518182229	1	20,81	145
N0607M06	7311518182236	1	29,71	145
N1213M06	7311518134570	1	47,47	145
N1213M06X	7311518237172	1	47,26	145
N1613M06	7311518136000	1	62,02	145
N1613M06X	7311518204525	1	61,75	145
N1613M08	7311518182267	1	62,02	145
NP-12-COM	7311518264277	4	15,41	560
NP-12-TEN	7311518263959	10	18,09	564
NP-12-VEN	7311518264260	10	18,92	564
NP-16-U7/8-HP	7311518241773	4	14,52	561
NP-19-U7/8-HP	7311518241452	10	14,52	561
NP-22-F7/8-HP	7311518035204	10	15,83	562
NP-22-U7/8-HP	7311518034399	10	15,51	561
NS001-150	7314150316069	5	104,53	506
NS001-200	7314150316076	5	119,66	506
NS001-250	7314150316083	5	160,91	506
NS001-300	7314150316090	5	204,94	506
NS001-375	7314150325108	5	316,33	506
NS001-450	7314150325115	3	440,13	506
NS001-600	7314150325122	1	715,21	506
NS001-900	7314150325139	1	1.608,05	506
NS002-10	7314150284719	10	35,62	506
NS002-11	7314150292592	5	44,65	506
NS002-12	7314150292608	5	44,65	506
NS002-13	7314150284726	10	44,65	506
NS002-14	7314150284733	5	47,29	506
NS002-15	7314150292615	5	49,92	506
NS002-16	7314150292622	5	52,55	506
NS002-17	7314150284740	10	65,67	506
NS002-18	7314150292639	5	68,30	506
NS002-19	7314150284757	10	70,92	506
NS002-20	7314150292646	5	73,56	506
NS002-21	7314150292653	5	76,18	506
NS002-22	7314150292660	10	78,80	506



NS002-23	7314150292677	5	84,07	506
NS002-24	7314150292684	10	89,33	506
NS002-25	7314150292691	5	91,94	506
NS002-26	7314150292707	5	105,09	506
NS002-27	7314150284764	5	105,09	506
NS002-28	7314150292714	5	113,61	506
NS002-29	7314150292721	10	116,25	506
NS002-30	7314150292738	10	124,77	506
NS002-31	7314150292745	5	131,36	506
NS002-32	7314150284771	5	137,91	506
NS002-33	7314150292752	5	150,46	506
NS002-34	7314150292769	5	154,18	506
NS002-35	7314150292776	5	157,62	506
NS002-36	7314150284788	5	164,19	506
NS002-38	7314150292783	5	170,75	506
NS002-40	7314150292790	5	183,89	506
NS002-41	7314150292806	5	210,15	506
NS002-42	7314150292813	5	223,30	506
NS002-46	7314150292820	5	236,44	506
NS002-50	7314150292837	5	302,10	506
NS002-52	7314150292844	5	304,75	506
NS002-55	7314150292851	5	309,06	506
NS002-6	7314150292554	5	34,97	506
NS002-60	7314150292868	1	343,49	506
NS002-65	7314150292875	1	435,97	506
NS002-7	7314150292561	5	39,64	506
NS002-70	7314150292882	1	502,04	506
NS002-75	7314150292899	1	581,29	506
NS002-8	7314150292578	5	39,64	506
NS002-80	7314150292905	1	686,98	506
NS002-9	7314150292585	5	40,96	506
NS003-11	7314150306602	1	37,51	506
NS003-12	7314150306619	1	38,63	506
NS003-14	7314150306626	1	40,60	506
NS003-16	7314150306633	1	45,56	506
NS003-18	7314150320356	1	49,52	506
NS003-20	7314150320363	1	54,10	506
NS003-24	7314150320370	1	68,73	506
NS003-28	7314150320387	1	76,76	506
NS003-30	7314150320394	1	95,43	506
NS003-8	7314150320349	1	32,49	506
NS006-0607	7314150292912	1	17,98	507
NS006-0608	7314150292929	1	18,31	507
NS006-0708	7314150292936	1	17,99	507
NS006-0709	7314150292943	1	18,29	507
NS006-0809	7314150292967	1	17,99	507
NS006-0810	7314150292950	1	19,04	507
NS006-0910	7314150292974	1	19,37	507
NS006-0911	7314150292981	1	23,28	507
NS006-1011	7314150292998	1	22,59	507
NS006-1012	7314150293001	1	25,39	507
NS006-1013	7314150293018	1	25,82	507
NS006-1014	7314150293025	1	26,03	507
NS006-1113	7314150293032	1	29,63	507
NS006-1114	7314150293049	1	30,12	507
NS006-1213	7314150293056	1	28,24	507
NS006-1214	7314150293063	1	38,57	507
NS006-1315	7314150293070	1	42,32	507
NS006-1415	7314150293087	1	33,89	507
NS006-1416	7314150293094	1	42,32	507
NS006-1417	7314150293100	1	33,89	507
NS006-1617	7314150293117	1	36,70	507
NS006-1618	7314150293124	1	36,70	507
NS006-1719	7314150293131	1	36,70	507
NS006-1722	7314150293148	1	42,36	507
NS006-1819	7314150293155	1	42,36	507
NS006-1820	7314150293162	1	45,00	507
NS006-1920	7314150293179	1	45,18	507
NS006-1922	7314150293186	1	50,83	507
NS006-1924	7314150293193	1	50,83	507
NS006-2022	7314150293209	1	50,83	507
NS006-2122	7314150293216	1	51,25	507
NS006-2123	7314150293223	1	53,64	507
NS006-2223	7314150293230	1	56,48	507
NS006-2224	7314150293247	1	56,94	507
NS006-2227	7314150293254	1	63,53	507
NS006-2326	7314150293261	1	64,63	507
NS006-2425	7314150293278	1	69,40	507
NS006-2426	7314150293285	1	70,60	507
NS006-2427	7314150293292	1	49,92	507
NS006-2430	7314150293308	1	56,44	507
NS006-2528	7314150293315	1	52,55	507
NS006-2629	7314150293322	1	53,91	507
NS006-2729	7314150293339	1	60,42	507
NS006-2730	7314150293346	1	75,35	507
NS006-2732	7314150293353	1	84,40	507
NS006-2830	7314150293360	1	84,40	507
NS006-3031	7314150293377	1	87,41	507
NS006-3032	7314150293384	1	105,88	507
NS006-3034	7314150293391	1	92,83	507
NS006-3036	7314150293407	1	92,83	507
NS006-3234	7314150293414	1	92,83	507
NS006-3235	7314150293421	1	92,83	507
NS006-3236	7314150293438	1	134,11	507
NS006-3335	7314150293445	1	141,13	507
NS006-3436	7314150293452	1	141,13	507



NS006-3536	7314150293469	1	141,13	507
NS006-3638	7314150293476	1	206,20	507
NS006-3641	7314150293483	1	206,20	507
NS006-3642	7314150293490	1	229,11	507
NS006-4146	7314150293506	1	211,77	507
NS006-4650	7314150293513	1	297,85	507
NS006-5052	7314150293520	1	302,43	507
NS006-5055	7314150293537	1	307,01	507
NS006-5060	7314150293544	1	311,59	507
NS006-5062	7314150293551	1	423,53	507
NS006-5560	7314150293568	1	451,76	507
NS006-6065	7314150293575	1	550,59	507
NS006-6570	7314150293582	1	564,71	507
NS010-0607	7314150293599	1	35,45	508
NS010-0709	7314150293605	1	35,45	508
NS010-0809	7314150293612	1	37,62	508
NS010-0911	7314150293629	1	39,80	508
NS010-1011	7314150293636	1	39,80	508
NS010-1012	7314150293643	1	41,34	508
NS010-1214	7314150293650	1	42,91	508
NS010-1315	7314150293667	1	50,99	508
NS010-1417	7314150293674	1	50,99	508
NS010-1618	7314150293681	1	67,77	508
NS010-1719	7314150293698	1	74,61	508
NS010-1722	7314150293704	1	82,07	508
NS010-1819	7314150293711	1	74,61	508
NS010-1921	7314150293728	1	90,77	508
NS010-1922	7314150293735	1	92,93	508
NS010-2022	7314150293742	1	95,12	508
NS010-2123	7314150293759	1	102,59	508
NS010-2224	7314150293766	1	111,91	508
NS010-2427	7314150293773	1	131,80	508
NS010-2528	7314150293780	1	147,36	508
NS010-2628	7314150293797	1	150,38	508
NS010-2730	7314150293803	1	153,42	508
NS010-2732	7314150293810	1	169,26	508
NS010-3032	7314150293827	1	179,68	508
NS010-3036	7314150293834	1	224,58	508
NS010-3236	7314150293841	1	269,51	508
NS010-3641	7314150293858	1	404,26	508
NS010-4146	7314150293865	1	440,77	508
NS010-4650	7314150293872	1	468,31	508
NS011-0607	7314150317271	1	24,85	508
NS011-0809	7314150317288	1	26,83	508
NS011-1011	7314150317295	1	32,47	508
NS011-1213	7314150317301	1	42,36	508
NS011-1415	7314150317318	1	48,01	508
NS011-1617	7314150317325	1	52,24	508
NS011-1819	7314150317332	1	64,94	508
NS011-2022	7314150317349	1	76,22	508
NS011-2123	7314150317356	1	79,08	508
NS011-2426	7314150317363	1	96,83	508
NS011-2528	7314150317370	1	96,83	508
NS011-2729	7314150317387	1	106,62	508
NS011-3032	7314150317394	1	130,56	508
NS041-12-50	7314150502547	1	2.040,81	524
NS041-16-100	7314150502561	1	2.320,37	524
NS041-16-200	7314150502332	1	2.523,90	524
NS041-16-260	7314150502585	1	2.722,94	524
NS041-24-670	7314150502608	1	8.092,78	524
NS041-32-900	7314150502622	1	9.192,02	524
NS041-8-25	7314150502646	1	1.516,07	524
NS100-100	7314150294305	1	1.300,30	509
NS100-105	7314150294312	1	1.581,89	509
NS100-110	7314150294329	1	1.400,91	509
NS100-115	7314150294336	1	1.678,68	509
NS100-120	7314150294343	1	1.795,53	509
NS100-17	7314150293889	1	77,16	508
NS100-19	7314150293896	1	80,23	508
NS100-22	7314150293902	1	83,33	508
NS100-24	7314150293919	1	89,49	508
NS100-25	7314150293926	1	100,32	508
NS100-27	7314150293933	1	101,25	508
NS100-28	7314150293940	1	102,22	508
NS100-29	7314150293957	1	104,92	508
NS100-30	7314150293964	1	105,92	508
NS100-32	7314150293971	1	111,49	508
NS100-33	7314150293988	1	118,05	508
NS100-34	7314150293995	1	140,21	508
NS100-35	7314150294008	1	146,60	508
NS100-36	7314150294015	1	148,00	508
NS100-37	7314150294022	1	162,03	508
NS100-38	7314150294039	1	163,56	508
NS100-41	7314150294046	1	177,45	508
NS100-42	7314150294053	1	207,96	508
NS100-45	7314150294060	1	223,76	509
NS100-46	7314150294077	1	225,89	509
NS100-47	7314150294084	1	243,05	509
NS100-50	7314150294091	1	262,33	509
NS100-52	7314150294107	1	288,57	509
NS100-54	7314150294114	1	300,92	509
NS100-55	7314150294121	1	300,92	509
NS100-56	7314150294138	1	315,24	509
NS100-58	7314150294145	1	378,05	509
NS100-60	7314150294152	1	381,66	509
NS100-63	7314150294169	1	404,92	509



NS100-65



NS100-65	7314150294176	1	416,64	509
NS100-67	7314150294183	1	495,99	509
NS100-70	7314150294190	1	547,81	509
NS100-71	7314150294206	1	573,90	509
NS100-75	7314150294213	1	616,88	509
NS100-77	7314150294220	1	688,70	509
NS100-80	7314150294237	1	727,46	509
NS100-82	7314150294244	1	797,72	509
NS100-85	7314150294251	1	828,87	509
NS100-88	7314150294268	1	939,09	509
NS100-90	7314150294275	1	847,06	509
NS100-94	7314150294282	1	868,40	509
NS100-95	7314150294299	1	847,06	509
NS104-100	7314150294947	1	788,11	509
NS104-105	7314150294954	1	853,79	509
NS104-110	7314150294961	1	1.011,42	509
NS104-115	7314150294978	1	1.011,42	509
NS104-120	7314150294985	1	1.313,51	509
NS104-17	7314150294350	1	84,08	509
NS104-19	7314150294367	1	85,62	509
NS104-20	7314150294374	1	86,37	509
NS104-22	7314150294381	1	87,14	509
NS104-24	7314150284795	1	88,68	509
NS104-25	7314150294398	1	99,67	509
NS104-26	7314150294404	1	99,72	509
NS104-27	7314150284801	1	99,72	509
NS104-28	7314150294411	1	104,62	509
NS104-29	7314150294428	1	106,95	509
NS104-30	7314150284818	1	111,10	509
NS104-31	7314150294435	1	114,64	509
NS104-32	7314150284825	1	116,54	509
NS104-33	7314150294442	1	127,87	509
NS104-34	7314150294459	1	135,22	509
NS104-35	7314150294466	1	138,75	509
NS104-36	7314150284832	1	136,00	509
NS104-37	7314150294473	1	136,63	509
NS104-38	7314150294480	1	142,40	509
NS104-39	7314150294497	1	172,15	509
NS104-40	7314150294503	1	175,39	509
NS104-41	7314150284849	1	178,31	509
NS104-42	7314150294510	1	193,92	509
NS104-43	7314150294527	1	198,98	509
NS104-44	7314150294534	1	193,92	509
NS104-45	7314150294541	1	197,30	509
NS104-46	7314150284856	1	202,36	509
NS104-47	7314150294558	1	219,07	509
NS104-48	7314150294565	1	222,88	509
NS104-49	7314150294572	1	226,70	509
NS104-50	7314150284863	1	230,50	509
NS104-51	7314150294589	1	236,24	509
NS104-52	7314150294596	1	242,04	509
NS104-53	7314150294602	1	243,97	509
NS104-54	7314150294619	1	245,91	509
NS104-55	7314150284870	1	262,69	509
NS104-56	7314150294626	1	269,82	509
NS104-57	7314150294633	1	274,33	509
NS104-58	7314150294640	1	278,82	509
NS104-59	7314150294657	1	283,32	509
NS104-60	7314150284887	1	308,67	509
NS104-61	7314150294664	1	319,64	509
NS104-62	7314150294671	1	326,08	509
NS104-63	7314150294688	1	336,30	509
NS104-64	7314150294695	1	346,47	509
NS104-65	7314150294701	1	337,02	509
NS104-66	7314150294718	1	327,91	509
NS104-67	7314150294725	1	333,17	509
NS104-68	7314150294732	1	402,24	509
NS104-69	7314150294749	1	402,24	509
NS104-70	7314150284894	1	380,90	509
NS104-71	7314150294756	1	405,11	509
NS104-72	7314150294763	1	407,99	509
NS104-73	7314150294770	1	410,85	509
NS104-74	7314150294787	1	413,73	509
NS104-75	7314150284900	1	459,72	509
NS104-76	7314150294794	1	478,15	509
NS104-77	7314150294800	1	484,12	509
NS104-78	7314150294817	1	498,24	509
NS104-79	7314150294824	1	512,39	509
NS104-80	7314150284917	1	526,53	509
NS104-81	7314150294831	1	555,99	509
NS104-82	7314150294848	1	562,55	509
NS104-83	7314150294855	1	569,12	509
NS104-84	7314150294862	1	575,68	509
NS104-85	7314150284924	1	582,25	509
NS104-86	7314150294879	1	644,98	509
NS104-87	7314150294886	1	659,19	509
NS104-88	7314150294893	1	673,39	509
NS104-89	7314150294909	1	687,61	509
NS104-90	7314150284931	1	647,85	509
NS104-92	7314150294916	1	738,05	509
NS104-94	7314150294923	1	747,26	509
NS104-95	7314150284948	1	669,92	509
NS104-98	7314150294930	1	794,85	509
NS106-100	7314150295418	1	634,88	510
NS106-104	7314150295425	1	652,51	510
NS106-108	7314150295432	1	668,82	510



NS106-112	7314150295449	1	692,18	510
NS106-114	7314150295456	1	731,87	510
NS106-116	7314150295463	1	828,20	510
NS106-120	7314150295470	1	863,55	510
NS106-124	7314150295487	1	932,62	510
NS106-126	7314150295494	1	1.007,22	510
NS106-128	7314150295500	1	1.047,52	510
NS106-132	7314150295517	1	1.087,81	510
NS106-136	7314150295524	1	1.265,21	510
NS106-138	7314150295531	1	1.296,82	510
NS106-144	7314150295548	1	1.547,52	510
NS106-146	7314150295555	1	1.566,62	510
NS106-150	7314150295562	1	1.661,61	510
NS106-156	7314150295579	1	1.857,11	510
NS106-158	7314150295586	1	2.657,99	510
NS106-20	7314150294992	1	60,62	510
NS106-22	7314150295005	1	76,94	510
NS106-24	7314150295012	1	81,07	510
NS106-25	7314150295029	1	86,85	510
NS106-26	7314150295036	1	88,41	510
NS106-28	7314150295043	1	91,25	510
NS106-30	7314150295050	1	92,79	510
NS106-32	7314150295067	1	94,30	510
NS106-34	7314150295074	1	97,34	510
NS106-36	7314150295081	1	100,39	510
NS106-38	7314150295098	1	103,30	510
NS106-40	7314150295104	1	105,09	510
NS106-42	7314150295111	1	97,59	510
NS106-44	7314150295128	1	100,13	510
NS106-45	7314150295135	1	102,47	510
NS106-46	7314150295142	1	133,91	510
NS106-48	7314150295159	1	135,90	510
NS106-50	7314150295166	1	141,36	510
NS106-52	7314150295173	1	171,13	510
NS106-54	7314150295180	1	154,78	510
NS106-56	7314150295197	1	158,55	510
NS106-58	7314150295203	1	197,01	510
NS106-60	7314150295210	1	215,12	510
NS106-62	7314150295227	1	195,96	510
NS106-64	7314150295234	1	229,10	510
NS106-66	7314150295241	1	214,47	510
NS106-68	7314150295258	1	226,82	510
NS106-70	7314150295265	1	239,20	510
NS106-71	7314150295272	1	239,20	510
NS106-72	7314150295289	1	280,77	510
NS106-74	7314150295296	1	295,54	510
NS106-76	7314150295302	1	302,10	510
NS106-78	7314150295319	1	286,45	510
NS106-80	7314150295326	1	315,25	510
NS106-82	7314150295333	1	316,03	510
NS106-84	7314150295340	1	328,37	510
NS106-88	7314150295357	1	394,04	510
NS106-90	7314150295364	1	405,60	510
NS106-92	7314150295371	1	423,23	510
NS106-94	7314150295388	1	446,59	510
NS106-96	7314150295395	1	472,86	510
NS106-98	7314150295401	1	462,94	510
NS200-1200	7314150295661	1	1.715,14	511
NS200-200	7314150295593	1	196,47	511
NS200-250	7314150295609	1	228,15	511
NS200-300	7314150295616	1	247,18	511
NS200-350	7314150295623	1	291,53	511
NS200-450	7314150295630	1	493,78	511
NS200-600	7314150295647	1	728,33	511
NS200-900	7314150295654	1	1.255,20	511
NS202-350	7314150299690	1	255,96	511
NS203-200	7314150359509	1	85,70	511
NS203-215	7314150359516	1	128,48	511
NS203-290	7314150359523	1	139,82	511
NS203-400	7314150359530	1	183,74	511
NS203-490	7314150359547	1	273,19	511
NS203-800	7314150359554	1	647,86	511
NS204-30	7314150295685	1	149,30	511
NS204-32	7314150295692	1	203,18	511
NS204-35	7314150295708	1	168,20	511
NS204-40	7314150295715	1	203,18	511
NS204-45	7314150295722	1	223,95	511
NS204-48	7314150295739	1	246,63	511
NS204-50	7314150295746	1	260,79	511
NS204-55	7314150295753	1	271,19	511
NS204-60	7314150295760	1	289,15	511
NS204-65	7314150295777	1	324,12	511
NS204-70	7314150295784	1	362,86	511
NS204-75	7314150295791	1	405,39	511
NS204-80	7314150295807	1	463,03	511
NS204-85	7314150295814	1	521,61	511
NS204-90	7314150295821	1	548,08	511
NS220-06	7314150347216	1	63,35	512
NS220-07	7314150347223	1	64,94	512
NS220-08	7314150347230	1	66,52	512
NS220-09	7314150347247	1	68,10	512
NS220-10	7314150347254	1	69,70	512
NS220-11	7314150347261	1	71,26	512
NS220-12	7314150347278	1	72,86	512
NS220-13	7314150347285	1	74,45	512
NS220-14	7314150347292	1	76,04	512



NS220-15	7314150347308	1	77,61	512
NS220-16	7314150347315	1	79,20	512
NS220-17	7314150347322	1	85,53	512
NS220-18	7314150347339	1	87,10	512
NS220-19	7314150347346	1	88,69	512
NS220-20	7314150347353	1	90,28	512
NS220-21	7314150347360	1	95,04	512
NS220-22	7314150347377	1	98,20	512
NS220-23	7314150347384	1	101,37	512
NS220-24	7314150347391	1	107,69	512
NS220-25	7314150347407	1	110,87	512
NS220-26	7314150347414	1	118,79	512
NS220-27	7314150347421	1	123,55	512
NS220-28	7314150347438	1	126,71	512
NS220-29	7314150347445	1	138,24	512
NS220-30	7314150347452	1	139,38	512
NS220-32	7314150347469	1	142,55	512
NS220-34	7314150347476	1	123,41	512
NS220-36	7314150347483	1	135,75	512
NS220-41	7314150347490	1	164,99	512
NS224-17	7314150355525	1	86,88	512
NS224-18	7314150355532	1	87,15	512
NS224-19	7314150355549	1	87,42	512
NS224-21	7314150355556	1	96,15	512
NS224-22	7314150355563	1	97,18	512
NS224-23	7314150355570	1	102,66	512
NS224-24	7314150355587	1	128,85	512
NS224-26	7314150355594	1	130,21	512
NS224-27	7314150355617	1	138,14	512
NS224-28	7314150355624	1	145,04	512
NS224-29	7314150355631	1	155,09	512
NS224-30	7314150355648	1	163,55	512
NS224-32	7314150355655	1	184,72	512
NS224-34	7314150355662	1	199,55	512
NS224-36	7314150355679	1	212,77	512
NS224-38	7314150355686	1	227,60	512
NS224-41	7314150355693	1	250,89	512
NS224-46	7314150355709	1	296,39	512
NS224-50	7314150355716	1	324,99	512
NS228-22	7314150355914	1	127,64	513
NS228-24	7314150355921	1	140,95	513
NS228-26	7314150355938	1	174,22	513
NS228-27	7314150355945	1	180,25	513
NS228-28	7314150355952	1	183,89	513
NS228-29	7314150355969	1	188,13	513
NS228-30	7314150355976	1	192,35	513
NS228-31	7314150355983	1	208,09	513
NS228-32	7314150355990	1	222,60	513
NS228-34	7314150356003	1	234,71	513
NS228-36	7314150356010	1	251,65	513
NS228-38	7314150356027	1	270,99	513
NS228-41	7314150356034	1	307,89	513
NS228-46	7314150356041	1	342,38	513
NS228-50	7314150356058	1	376,25	513
NS228-55	7314150356065	1	424,64	513
NS228-60	7314150356072	1	474,24	513
NS228-65	7314150356089	1	526,26	513
NS228-70	7314150356096	1	579,50	513
NS228-75	7314150356102	1	632,73	513
NS228-80	7314150356119	1	687,78	513
NS232-16-24	7314150356331	1	124,02	513
NS232-24-16	7314150356355	1	151,27	513
NS232-24-32	7314150356348	1	253,04	513
NS232-32-24	7314150356362	1	245,70	513
NS234-16-100	7314150356416	1	120,26	513
NS234-16-200	7314150356423	1	132,06	513
NS234-16-250	7314150356430	1	145,04	513
NS234-24-200	7314150356447	1	198,07	513
NS234-32-250	7314150356454	1	341,94	513
NS236-16	7314150356522	1	146,99	513
NS236-24	7314150356539	1	354,77	513
NS236-32	7314150356515	1	484,52	513
NS238-16-250	7314150356577	1	206,35	514
NS238-24-250	7314150356584	1	409,14	514
NS238-32-300	7314150356591	1	514,09	514
NS240-16-230	7314150356737	1	189,92	514
NS242-16	7314150356638	1	308,92	514
NS242-24	7314150356645	1	496,40	514
NS242-32	7314150356652	1	962,92	514
NS243-16-400	7314150356690	1	241,91	514
NS247-26	7314150356751	1	146,32	515
NS248-16-52	7314150356713	1	78,33	515
NS300-10-200	7314150317783	1	71,51	515
NS300-10-300	7314150316205	1	93,25	515
NS300-11-250	7314150317790	1	85,48	515
NS300-11-300	7314150317806	1	101,02	515
NS300-11-350	7314150316212	1	116,56	515
NS300-12-400	7314150325153	1	122,78	515
NS300-13-450	7314150325160	1	132,11	515
NS300-3-50	7314150317677	1	16,94	515
NS300-3-75	7314150317684	1	19,76	515
NS300-4-75	7314150317691	1	21,18	515
NS300-4-5-100	7314150316175	1	25,67	515
NS300-4-5-50	7314150317707	1	18,36	515
NS300-5-100	7314150317721	1	25,40	515
NS300-5-75	7314150317714	1	22,59	515



NS300-6-100	7314150316182	1	26,83	515
NS300-6-125	7314150317738	1	30,39	515
NS300-6-150	7314150317745	1	33,57	515
NS300-7-150	7314150317752	1	38,00	515
NS300-8-150	7314150316199	1	41,34	515
NS300-8-200	7314150317769	1	49,43	515
NS300-9-250	7314150317776	1	56,48	515
NS301-10-200	7314150317882	1	76,18	515
NS301-10-300	7314150317899	1	90,55	515
NS301-3-50	7314150317813	1	21,18	515
NS301-4-100	7314150317820	1	26,83	515
NS301-4-150	7314150317837	1	44,77	515
NS301-5-100	7314150317844	1	41,86	515
NS301-5-200	7314150317851	1	44,86	515
NS301-6-100	7314150317868	1	44,99	515
NS301-8-150	7314150317875	1	60,91	515
NS302-0-50	7314150316229	1	23,99	516
NS302-1-100	7314150316236	1	23,99	516
NS302-2-125	7314150316243	1	30,57	516
NS302-3-150	7314150316250	1	42,36	516
NS302-4-300	7314150316267	1	67,77	516
NS304-0-50	7314150316274	1	23,99	516
NS304-1-100	7314150316281	1	23,99	516
NS304-2-125	7314150316298	1	28,24	516
NS304-3-150	7314150316304	1	42,36	516
NS304-4-300	7314150316311	1	67,77	516
NS320-10	7314150318162	1	47,41	516
NS320-2	7314150318087	1	30,75	516
NS320-3	7314150318094	1	31,12	516
NS320-4	7314150318100	1	31,61	516
NS320-5	7314150318117	1	32,98	516
NS320-6	7314150318124	1	34,39	516
NS320-7	7314150318131	1	38,08	516
NS320-8	7314150318148	1	39,95	516
NS320-9	7314150318155	1	44,15	516
NS400-160	7314150316106	1	127,05	516
NS400-180	7314150316113	1	141,17	516
NS400-200	7314150316120	1	155,30	516
NS402-160	7314150316137	1	165,00	517
NS402-200	7314150325177	1	169,41	517
NS403-160	7314150318209	1	155,30	517
NS403-180	7314150318193	1	169,41	517
NS404-160	7314150318216	1	119,99	517
NS405-160	7314150318247	1	119,99	517
NS406-160	7314150316144	1	127,05	517
NS406-180	7314150318261	1	152,13	517
NS406-200	7314150316151	1	152,88	517
NS407-160	7314150318278	1	276,95	517
NS408-250	7314150316168	1	191,24	518
NS408-300	7314150318292	1	231,59	518
NS411-200	7314150318322	1	183,53	518
NS412-200	7314150318339	1	112,93	518
NS413-180	7314150318384	1	286,08	518
NS413-200	7314150318377	1	286,08	518
NS500-1000-FB	7314150296019	1	155,44	519
NS500-1500-FB	7314150296026	1	179,24	519
NS500-2000	7314150291847	1	271,58	519
NS500-2000-FB	7314150284955	1	219,47	519
NS500-2500	7314150291854	1	339,38	519
NS500-2500-FB	7314150284962	1	275,28	519
NS500-3000	7314150291861	1	407,18	519
NS500-3000-FB	7314150284979	1	310,59	519
NS500-3500-FB	7314150284986	1	438,92	519
NS500-4000	7314150291878	1	539,76	519
NS502-1000-FB	7314150284993	1	118,81	519
NS502-10000-FB	7314150285068	1	919,47	519
NS502-12000-FB	7314150318407	1	1.050,82	519
NS502-1500-FB	7314150318438	1	157,62	519
NS502-2000-FB	7314150285006	1	192,19	519
NS502-2500-FB	7314150285013	1	244,61	519
NS502-3000-FB	7314150285020	1	297,02	519
NS502-450-FB	7314150296033	1	88,33	519
NS502-4500-FB	7314150285037	1	354,65	519
NS502-5000-FB	7314150285044	1	420,32	519
NS502-6800-FB	7314150318445	1	551,68	519
NS502-8000-FB	7314150285051	1	660,00	519
NS504-100-FB	7314150296040	1	56,48	519
NS504-1000-FB	7314150285099	1	155,44	519
NS504-1500-FB	7314150285105	1	183,53	519
NS504-200-FB	7314150296057	1	60,00	519
NS504-2000-FB	7314150285112	1	225,87	519
NS504-300-FB	7314150296064	1	64,94	519
NS504-500-FB	7314150285075	1	88,94	519
NS504-800-FB	7314150285082	1	117,16	519
NS506-300	7314150285129	1	54,86	519
NS506-300-FB	7314150318469	1	55,70	520
NS506-450	7314150285136	1	73,15	519
NS506-450-FB	7314150318476	1	74,26	520
NS506-700	7314150296071	1	102,88	519
NS506-700-FB	7314150285143	1	94,06	520
NS506-900	7314150296088	1	137,15	519
NS506-900-FB	7314150285150	1	143,13	520
NS508-500-FB	7314150318544	1	88,75	520
NS508-700-FB	7314150318537	1	104,88	520
NS512-200-FB	7314150318568	1	75,83	520
NS512-400-FB	7314150318575	1	95,20	520



NS512-600-FB



NS512-600-FB	7314150318582	1	104,88	520
NS512-900-FB	7314150318599	1	127,46	520
NS600-100-50	7314150296101	1	36,57	520
NS600-135-50	7314150296118	1	69,50	520
NS600-150-25	7314150296125	1	32,92	520
NS600-150-30	7314150301676	1	29,28	520
NS600-150-40	7314150296132	1	36,57	520
NS600-150-50	7314150296149	1	62,18	520
NS600-180-13	7314150296156	1	29,28	520
NS600-180-32	7314150296167	1	42,06	520
NS600-180-50	7314150285174	1	93,27	520
NS600-200-20	7314150296163	1	82,30	520
NS600-200-30	7314150296170	1	100,58	520
NS600-200-40	7314150296187	1	147,65	520
NS600-200-50	7314150301782	1	72,46	520
NS600-230-40	7314150296194	1	106,08	520
NS600-250-40	7314150296200	1	164,59	520
NS600-300-50	7314150296217	1	321,88	520
NS600-80-13	7314150296095	1	9,87	520
NS602-460	7314150285181	1	148,04	521
NS602-600	7314150285198	1	203,95	521
NS602-760	7314150296224	1	313,26	521
NS602-900	7314150296231	1	364,01	521
NS604-150	7314150296248	1	101,08	521
NS604-200	7314150285204	1	162,15	521
NS604-300	7314150285211	1	265,23	521
NS606-150	7314150285228	1	55,26	521
NS606-200	7314150285235	1	71,05	521
NS606-250	7314150285242	1	96,05	521
NS606-300	7314150285259	1	114,45	521
NS606-400	7314150285266	1	147,37	521
NS608-100	7314150285273	1	33,84	521
NS700-300	7314150325184	1	63,47	521
NS702-200	7314150325191	1	54,20	522
NS704-225	7314150325207	1	120,63	522
NS706-50	7314150325214	1	76,30	522
NS706-80	7314150325221	1	117,09	522
NS708-360	7314150325238	1	163,88	522
NS710-450	7314150325245	1	348,50	523
NS800-1100	7314150296323	1	167,93	523
NS800-1700	7314150285280	1	245,50	523
NS800-2000	7314150296330	1	292,94	523
NS802-290	7314150285297	1	223,13	523
NS804-290	7314150296347	1	49,81	523
NS810-100	7314150318728	1	1.059,01	523
NS810-150	7314150318711	1	1.175,67	523
NS810-200	7314150318704	1	1.256,16	523
NS810-350	7314150318698	1	1.882,02	523
NSB001-150	7314150292509	5	148,54	506
NSB001-200	7314150284689	5	185,67	506
NSB001-250	7314150284696	5	247,58	506
NSB001-300	7314150284702	5	275,08	506
NSB001-375	7314150292516	5	417,45	506
NSB001-450	7314150292523	3	567,02	506
NSB001-600	7314150292530	3	1.046,88	506
NSB001-900	7314150292547	1	2.343,32	506
NSB002-10	7314150316366	5	48,60	506
NSB002-11	7314150316373	5	52,55	506
NSB002-12	7314150316380	5	57,80	506
NSB002-13	7314150316397	5	60,42	506
NSB002-14	7314150316403	5	63,05	506
NSB002-15	7314150316410	5	72,12	506
NSB002-16	7314150316427	5	74,88	506
NSB002-17	7314150316434	5	85,37	506
NSB002-18	7314150316441	5	89,33	506
NSB002-19	7314150316458	5	91,94	506
NSB002-20	7314150316465	5	94,57	506
NSB002-21	7314150316472	5	102,47	506
NSB002-22	7314150316489	5	105,09	506
NSB002-23	7314150316496	5	110,33	506
NSB002-24	7314150316502	5	124,77	506
NSB002-25	7314150316519	5	131,36	506
NSB002-26	7314150316526	5	137,39	506
NSB002-27	7314150316533	5	140,84	506
NSB002-28	7314150316540	5	173,76	506
NSB002-29	7314150316557	5	177,81	506
NSB002-30	7314150316564	5	191,95	506
NSB002-31	7314150321728	1	232,37	506
NSB002-32	7314150316571	10	242,46	506
NSB002-33	7314150321735	1	244,03	506
NSB002-34	7314150321742	1	249,62	506
NSB002-35	7314150321759	1	252,57	506
NSB002-36	7314150321766	5	272,77	506
NSB002-38	7314150321773	1	292,98	506
NSB002-40	7314150321780	1	321,26	506
NSB002-41	7314150321797	5	345,50	506
NSB002-42	7314150321803	1	363,70	506
NSB002-46	7314150321810	1	402,09	506
NSB002-50	7314150321827	1	444,51	506
NSB002-52	7314150321834	1	460,70	506
NSB002-55	7314150321841	1	484,92	506
NSB002-6	7314150316328	5	60,61	506
NSB002-60	7314150321858	1	525,33	506
NSB002-65	7314150321865	1	666,78	506
NSB002-7	7314150316335	5	60,61	506
NSB002-70	7314150321872	1	767,80	506



NSB002-75	7314150321889	1	889,05	506
NSB002-8	7314150316342	5	60,61	506
NSB002-80	7314150321896	1	1.050,68	506
NSB002-9	7314150316359	5	49,00	506
NSB003-10	7314150342709	1	33,09	506
NSB003-11	7314150342716	1	28,02	506
NSB003-12	7314150342723	5	28,02	506
NSB003-13	7314150342730	1	33,09	507
NSB003-14	7314150342747	1	44,69	507
NSB003-16	7314150342754	5	78,38	507
NSB003-18	7314150342761	1	78,38	507
NSB003-19	7314150342778	1	82,34	507
NSB003-20	7314150342785	1	74,16	507
NSB003-22	7314150342792	5	49,31	507
NSB003-24	7314150342808	5	777,79	507
NSB003-25	7314150342815	1	1.137,58	507
NSB003-26	7314150342822	1	897,77	507
NSB003-28	7314150342839	5	1.415,63	507
NSB003-30	7314150342846	1	1.157,03	507
NSB003-31	7314150342853	1	1.353,28	507
NSB003-32	7314150342860	1	477,92	507
NSB003-34	7314150342877	1	438,56	507
NSB003-36	7314150342884	1	547,60	507
NSB003-38	7314150342891	1	602,70	507
NSB003-40	7314150342907	1	841,41	507
NSB003-42	7314150342914	1	670,60	507
NSB003-44	7314150342921	5	1.045,55	507
NSB003-46	7314150342938	1	51,48	507
NSB003-48	7314150342945	1	53,92	507
NSB003-50	7314150342952	1	109,62	507
NSB003-52	7314150342969	1	339,88	507
NSB003-54	7314150342976	1	349,84	507
NSB003-56	7314150342983	1	5,14	507
NSB003-58	7314150342990	1	5,34	507
NSB003-60	7314150343010	1	6,13	507
NSB003-62	7314150343027	1	6,32	507
NSB003-64	7314150343034	5	50,62	507
NSB003-68	7314150343041	1	111,80	507
NSB003-72	7314150343058	1	131,71	507
NSB003-8	7314150342693	1	1.518,53	506
NSB003-80	7314150343065	1	40,81	507
NSB003-84	7314150343072	1	918,07	507
NSB003-88	7314150343089	1	9,42	507
NSB006-0607	7314150316588	1	22,74	507
NSB006-0608	7314150321926	1	23,16	507
NSB006-0708	7314150321933	1	25,76	507
NSB006-0709	7314150321940	1	26,19	507
NSB006-0809	7314150316595	1	25,78	507
NSB006-0810	7314150321957	1	27,28	507
NSB006-0910	7314150321964	1	27,73	507
NSB006-0911	7314150321971	1	33,34	507
NSB006-1011	7314150316601	1	33,89	507
NSB006-1012	7314150322015	1	36,70	507
NSB006-1013	7314150322022	1	37,32	507
NSB006-1014	7314150322039	1	39,53	507
NSB006-1113	7314150322046	1	45,00	507
NSB006-1114	7314150322053	1	45,75	507
NSB006-1213	7314150316618	1	45,18	507
NSB006-1214	7314150322060	1	45,55	507
NSB006-1315	7314150322077	1	49,98	507
NSB006-1415	7314150316625	1	50,83	507
NSB006-1416	7314150322084	1	59,36	507
NSB006-1417	7314150322091	1	60,85	507
NSB006-1617	7314150316632	1	59,30	507
NSB006-1618	7314150322107	1	59,77	507
NSB006-1719	7314150322114	1	67,96	507
NSB006-1722	7314150322121	1	75,52	507
NSB006-1819	7314150316649	1	76,78	507
NSB006-1820	7314150322138	1	77,41	507
NSB006-1920	7314150322145	1	78,67	507
NSB006-1922	7314150322152	1	79,93	507
NSB006-1924	7314150322169	1	88,26	507
NSB006-2022	7314150316656	1	87,53	507
NSB006-2122	7314150322176	1	88,26	507
NSB006-2123	7314150316663	1	88,97	507
NSB006-2223	7314150322183	1	89,68	507
NSB006-2224	7314150322190	1	90,40	507
NSB006-2227	7314150322206	1	95,50	507
NSB006-2326	7314150322213	1	102,60	507
NSB006-2425	7314150322220	1	104,31	507
NSB006-2426	7314150316670	1	106,01	507
NSB006-2427	7314150322237	1	115,96	507
NSB006-2430	7314150322244	1	117,42	507
NSB006-2528	7314150316687	1	119,37	507
NSB006-2629	7314150322251	1	128,84	507
NSB006-2729	7314150316694	1	128,84	507
NSB006-2730	7314150322336	1	128,84	507
NSB006-2732	7314150322343	1	144,29	507
NSB006-2830	7314150322350	1	144,29	507
NSB006-3031	7314150322367	1	149,45	507
NSB006-3032	7314150316700	1	155,30	507
NSB006-3034	7314150322374	1	164,94	507
NSB006-3036	7314150322381	1	164,94	507
NSB006-3234	7314150322398	1	164,94	507
NSB006-3235	7314150322404	1	164,94	507
NSB006-3236	7314150322411	1	164,94	507



NSB006-3335	7314150322428	1	164,94	507
NSB006-3436	7314150322435	1	164,94	507
NSB006-3536	7314150322442	1	164,94	507
NSB006-3638	7314150322459	1	240,97	507
NSB006-3641	7314150322466	1	240,97	507
NSB006-3642	7314150322473	1	267,75	507
NSB006-4146	7314150322480	1	310,59	507
NSB006-4650	7314150322497	1	381,17	507
NSB006-5052	7314150322503	1	387,05	507
NSB006-5055	7314150322510	1	392,90	507
NSB006-5060	7314150322527	1	398,76	507
NSB006-5062	7314150322534	1	404,63	507
NSB006-5560	7314150322558	1	516,05	507
NSB006-6065	7314150322565	1	539,51	507
NSB006-6570	7314150322572	1	574,69	507
NSB010-0607	7314150322589	1	47,42	508
NSB010-0709	7314150322596	1	47,42	508
NSB010-0809	7314150322602	1	46,45	508
NSB010-0911	7314150322619	1	50,06	508
NSB010-1011	7314150322626	1	50,06	508
NSB010-1012	7314150322633	1	55,48	508
NSB010-1214	7314150322640	1	60,93	508
NSB010-1315	7314150322657	1	72,74	508
NSB010-1417	7314150322664	1	72,74	508
NSB010-1618	7314150322671	1	96,98	508
NSB010-1719	7314150322688	1	106,95	508
NSB010-1722	7314150322695	1	115,31	508
NSB010-1819	7314150322718	1	106,95	508
NSB010-1921	7314150322725	1	117,35	508
NSB010-1922	7314150322732	1	118,25	508
NSB010-2022	7314150322749	1	119,14	508
NSB010-2123	7314150322756	1	127,84	508
NSB010-2224	7314150322763	1	151,79	508
NSB010-2427	7314150322770	1	164,83	508
NSB010-2528	7314150322787	1	183,84	508
NSB010-2628	7314150322794	1	194,48	508
NSB010-2730	7314150322800	1	205,10	508
NSB010-2732	7314150322817	1	212,38	508
NSB010-3032	7314150322824	1	239,20	508
NSB010-3036	7314150322831	1	299,01	508
NSB010-3236	7314150322848	1	358,80	508
NSB010-3641	7314150322855	1	538,19	508
NSB010-4146	7314150322862	1	650,31	508
NSB010-4650	7314150322879	1	731,60	508
NSB011-0607	7314150317400	1	29,65	508
NSB011-0809	7314150317417	1	32,01	508
NSB011-1011	7314150317424	1	40,95	508
NSB011-1213	7314150317431	1	59,30	508
NSB011-1415	7314150317448	1	73,41	508
NSB011-1617	7314150317455	1	84,70	508
NSB011-1819	7314150317462	1	107,29	508
NSB011-2022	7314150317479	1	129,87	508
NSB011-2123	7314150317486	1	135,52	508
NSB011-2426	7314150317493	1	167,51	508
NSB011-2528	7314150317509	1	168,02	508
NSB011-2729	7314150317516	1	182,12	508
NSB011-3032	7314150317523	1	225,87	508
NSB041-12-50	7314150502660	1	2.979,02	524
NSB041-16-100	7314150502684	1	3.444,21	524
NSB041-16-200	7314150502318	1	3.693,59	524
NSB041-16-260	7314150502707	1	3.942,95	524
NSB041-24-670	7314150502721	1	12.254,91	524
NSB041-32-900	7314150502745	1	14.454,50	524
NSB041-8-25	7314150502769	1	2.607,76	524
NSB100-100	7314150323302	1	1.552,87	509
NSB100-105	7314150323319	1	1.835,21	509
NSB100-110	7314150323326	1	1.976,44	509
NSB100-115	7314150323333	1	2.368,29	509
NSB100-120	7314150323340	1	2.533,18	509
NSB100-17	7314150322886	1	101,02	509
NSB100-19	7314150322893	1	105,08	509
NSB100-22	7314150322909	1	109,12	509
NSB100-24	7314150322916	1	117,21	509
NSB100-25	7314150322923	1	131,33	509
NSB100-27	7314150322930	1	131,33	509
NSB100-28	7314150322947	1	131,33	509
NSB100-29	7314150322954	1	161,64	509
NSB100-30	7314150322961	1	161,64	509
NSB100-32	7314150322978	1	163,00	509
NSB100-33	7314150322985	1	181,86	509
NSB100-34	7314150322992	1	181,86	509
NSB100-35	7314150323005	1	191,95	509
NSB100-36	7314150323012	1	191,95	509
NSB100-37	7314150323029	1	212,16	509
NSB100-38	7314150323036	1	212,16	509
NSB100-41	7314150323043	1	232,37	509
NSB100-42	7314150323050	1	267,21	509
NSB100-45	7314150323067	1	292,98	509
NSB100-46	7314150323074	1	292,98	509
NSB100-47	7314150323081	1	318,22	509
NSB100-50	7314150323098	1	343,50	509
NSB100-52	7314150323104	1	377,84	509
NSB100-54	7314150323111	1	394,01	509
NSB100-55	7314150323128	1	394,01	509
NSB100-56	7314150323135	1	409,82	509
NSB100-58	7314150323142	1	491,47	509



NSB100-60	7314150323159	1	496,18	509
NSB100-63	7314150323166	1	526,40	509
NSB100-65	7314150323173	1	541,63	509
NSB100-67	7314150323180	1	644,79	509
NSB100-70	7314150323197	1	712,15	509
NSB100-71	7314150323203	1	746,07	509
NSB100-75	7314150323210	1	801,95	509
NSB100-77	7314150323227	1	895,31	509
NSB100-80	7314150323234	1	945,69	509
NSB100-82	7314150323241	1	1.037,01	509
NSB100-85	7314150323258	1	1.077,52	509
NSB100-88	7314150323265	1	1.220,81	509
NSB100-90	7314150323272	1	1.364,10	509
NSB100-94	7314150323289	1	1.398,51	509
NSB100-95	7314150323296	1	1.433,46	509
NSB104-100	7314150316885	1	1.239,35	510
NSB104-105	7314150316892	1	1.315,39	510
NSB104-110	7314150316908	1	1.539,87	510
NSB104-115	7314150323937	1	2.310,95	510
NSB104-120	7314150316915	1	1.975,17	510
NSB104-17	7314150323357	1	98,52	510
NSB104-19	7314150323364	1	101,15	510
NSB104-20	7314150323371	1	106,40	510
NSB104-22	7314150323388	1	108,00	510
NSB104-24	7314150316717	1	109,00	510
NSB104-25	7314150323395	1	129,61	510
NSB104-26	7314150323401	1	129,62	510
NSB104-27	7314150316724	1	137,91	510
NSB104-28	7314150323418	1	136,00	510
NSB104-29	7314150323425	1	139,03	510
NSB104-30	7314150316731	1	144,50	510
NSB104-31	7314150323432	1	149,04	510
NSB104-32	7314150316748	1	157,62	510
NSB104-33	7314150323449	1	149,04	510
NSB104-34	7314150323456	1	149,04	510
NSB104-35	7314150323463	1	149,04	510
NSB104-36	7314150316755	1	183,89	510
NSB104-37	7314150323470	1	200,60	510
NSB104-38	7314150323487	1	217,80	510
NSB104-39	7314150323494	1	254,56	510
NSB104-40	7314150323500	1	268,23	510
NSB104-41	7314150316762	1	288,97	510
NSB104-42	7314150323517	1	296,60	510
NSB104-43	7314150323524	1	304,34	510
NSB104-44	7314150323531	1	296,60	510
NSB104-45	7314150323548	1	301,77	510
NSB104-46	7314150316779	1	309,51	510
NSB104-47	7314150323555	1	335,06	510
NSB104-48	7314150323562	1	340,88	510
NSB104-49	7314150323579	1	346,72	510
NSB104-50	7314150316786	1	361,22	510
NSB104-51	7314150323586	1	361,22	510
NSB104-52	7314150323593	1	380,90	510
NSB104-53	7314150323609	1	373,11	510
NSB104-54	7314150323616	1	376,08	510
NSB104-55	7314150316793	1	400,63	510
NSB104-56	7314150323623	1	412,67	510
NSB104-57	7314150323630	1	419,56	510
NSB104-58	7314150323647	1	426,43	510
NSB104-59	7314150323654	1	433,30	510
NSB104-60	7314150316809	1	440,19	510
NSB104-61	7314150323661	1	456,65	510
NSB104-62	7314150323678	1	465,84	510
NSB104-63	7314150323685	1	480,43	510
NSB104-64	7314150323692	1	494,96	510
NSB104-65	7314150316816	1	481,46	510
NSB104-66	7314150323708	1	501,51	510
NSB104-67	7314150323715	1	509,53	510
NSB104-68	7314150323722	1	615,18	510
NSB104-69	7314150323739	1	615,18	510
NSB104-70	7314150316823	1	615,21	510
NSB104-71	7314150323746	1	619,57	510
NSB104-72	7314150323753	1	623,97	510
NSB104-73	7314150323760	1	628,36	510
NSB104-74	7314150323777	1	632,77	510
NSB104-75	7314150316830	1	637,16	510
NSB104-76	7314150323784	1	668,36	510
NSB104-77	7314150323791	1	676,70	510
NSB104-78	7314150323807	1	696,44	510
NSB104-79	7314150323814	1	716,25	510
NSB104-80	7314150316847	1	736,02	510
NSB104-81	7314150323821	1	777,18	510
NSB104-82	7314150323838	1	786,35	510
NSB104-83	7314150323845	1	795,52	510
NSB104-84	7314150323852	1	804,69	510
NSB104-85	7314150316854	1	813,88	510
NSB104-86	7314150323869	1	901,59	510
NSB104-87	7314150323876	1	921,44	510
NSB104-88	7314150323883	1	941,29	510
NSB104-89	7314150323890	1	961,17	510
NSB104-90	7314150316861	1	905,58	510
NSB104-92	7314150323906	1	1.031,65	510
NSB104-94	7314150323913	1	1.044,56	510
NSB104-95	7314150316878	1	1.057,48	510
NSB104-98	7314150323920	1	1.215,65	510
NSB106-100	7314150324361	1	825,32	511





NSB106-104	7314150324378	1	848,24	511
NSB106-108	7314150324385	1	869,44	511
NSB106-112	7314150324392	1	899,86	511
NSB106-114	7314150324408	1	951,39	511
NSB106-116	7314150324415	1	1.076,65	511
NSB106-120	7314150324422	1	1.122,59	511
NSB106-124	7314150324439	1	1.212,40	511
NSB106-126	7314150324446	1	1.309,39	511
NSB106-128	7314150324453	1	1.361,79	511
NSB106-132	7314150324460	1	1.414,18	511
NSB106-136	7314150324477	1	1.644,78	511
NSB106-138	7314150324484	1	1.685,89	511
NSB106-144	7314150324491	1	2.011,79	511
NSB106-146	7314150324507	1	2.749,44	511
NSB106-150	7314150324514	1	2.818,14	511
NSB106-156	7314150324521	1	2.826,31	511
NSB106-158	7314150324538	1	3.454,89	511
NSB106-20	7314150323944	1	105,08	510
NSB106-22	7314150323951	1	117,69	510
NSB106-24	7314150323968	1	123,98	510
NSB106-25	7314150323975	1	96,63	510
NSB106-26	7314150323982	1	110,69	510
NSB106-28	7314150323999	1	131,84	510
NSB106-30	7314150324002	1	134,00	510
NSB106-32	7314150324019	1	136,23	510
NSB106-34	7314150324026	1	140,62	510
NSB106-36	7314150324033	1	145,02	510
NSB106-38	7314150324040	1	149,21	510
NSB106-40	7314150324057	1	164,79	510
NSB106-42	7314150324064	1	169,16	510
NSB106-44	7314150324071	1	173,58	510
NSB106-45	7314150324088	1	219,21	510
NSB106-46	7314150324095	1	232,14	510
NSB106-48	7314150324101	1	235,58	510
NSB106-50	7314150324118	1	245,02	510
NSB106-52	7314150324125	1	261,74	510
NSB106-54	7314150324132	1	282,40	510
NSB106-56	7314150324149	1	288,97	510
NSB106-58	7314150324156	1	317,08	510
NSB106-60	7314150324163	1	354,65	510
NSB106-62	7314150324170	1	367,79	511
NSB106-64	7314150324187	1	385,99	511
NSB106-66	7314150324194	1	367,79	511
NSB106-68	7314150324200	1	380,90	511
NSB106-70	7314150324217	1	394,04	511
NSB106-71	7314150324224	1	399,00	511
NSB106-72	7314150324231	1	427,37	511
NSB106-74	7314150324248	1	427,37	511
NSB106-76	7314150324255	1	441,15	511
NSB106-78	7314150324262	1	496,46	511
NSB106-80	7314150324279	1	502,95	511
NSB106-82	7314150324286	1	483,35	511
NSB106-84	7314150324293	1	527,29	511
NSB106-88	7314150324309	1	659,12	511
NSB106-90	7314150324316	1	660,00	511
NSB106-92	7314150324323	1	732,61	511
NSB106-94	7314150324330	1	745,89	511
NSB106-96	7314150324347	1	756,56	511
NSB106-98	7314150324354	1	802,41	511
NSB200-1200	7314150324613	1	2.687,31	511
NSB200-200	7314150324545	1	313,17	511
NSB200-250	7314150324552	1	363,70	511
NSB200-300	7314150324569	1	394,01	511
NSB200-350	7314150324576	1	464,73	511
NSB200-450	7314150324583	1	565,76	511
NSB200-600	7314150324590	1	848,62	511
NSB200-900	7314150324606	1	1.474,99	511
NSB202-350	7314150324620	1	301,93	511
NSB203-200	7314150359561	1	128,27	511
NSB203-215	7314150359578	1	183,54	511
NSB203-290	7314150359585	1	213,58	511
NSB203-400	7314150359592	1	262,48	511
NSB203-490	7314150359608	1	390,23	511
NSB203-800	7314150359615	1	925,54	511
NSB204-30	7314150324637	1	234,36	512
NSB204-32	7314150324644	1	322,21	512
NSB204-35	7314150324651	1	260,79	512
NSB204-40	7314150324668	1	322,21	512
NSB204-45	7314150324675	1	393,10	512
NSB204-48	7314150324682	1	426,18	512
NSB204-50	7314150324699	1	452,63	512
NSB204-55	7314150324705	1	540,50	512
NSB204-60	7314150324712	1	582,10	512
NSB204-65	7314150324729	1	663,35	512
NSB204-70	7314150324736	1	728,56	512
NSB204-75	7314150324743	1	810,77	512
NSB204-80	7314150324750	1	922,28	512
NSB204-85	7314150324767	1	1.026,22	512
NSB204-90	7314150324774	1	1.132,05	512
NSB220-06	7314150354023	1	71,65	512
NSB220-07	7314150354030	1	73,43	512
NSB220-08	7314150354047	1	75,23	512
NSB220-09	7314150354054	1	77,03	512
NSB220-10	7314150354061	1	71,40	512
NSB220-11	7314150354078	1	75,09	512
NSB220-12	7314150354085	1	80,01	512



NSB220-13	7314150354092	1	83,71	512
NSB220-14	7314150354108	1	84,93	512
NSB220-15	7314150354115	1	87,40	512
NSB220-16	7314150354122	1	90,47	512
NSB220-17	7314150354139	1	92,94	512
NSB220-18	7314150354146	1	96,01	512
NSB220-19	7314150354153	1	100,33	512
NSB220-20	7314150354160	1	101,56	512
NSB220-21	7314150354177	1	104,62	512
NSB220-22	7314150354184	1	108,32	512
NSB220-23	7314150354191	1	114,64	512
NSB220-24	7314150354207	1	121,80	512
NSB220-25	7314150354214	1	136,63	512
NSB220-26	7314150354221	1	146,49	512
NSB220-27	7314150354238	1	153,87	512
NSB220-28	7314150354245	1	162,49	512
NSB220-29	7314150354252	1	175,04	512
NSB220-30	7314150354269	1	180,95	512
NSB220-32	7314150354276	1	198,80	512
NSB224-17	7314150355723	1	119,72	512
NSB224-18	7314150355730	1	147,70	512
NSB224-19	7314150355747	1	120,26	512
NSB224-21	7314150355754	1	132,43	512
NSB224-22	7314150355761	1	135,60	512
NSB224-23	7314150355778	1	169,54	512
NSB224-24	7314150355785	1	152,26	512
NSB224-26	7314150355792	1	158,43	512
NSB224-27	7314150355808	1	161,21	512
NSB224-28	7314150355815	1	171,08	512
NSB224-29	7314150355822	1	207,28	512
NSB224-30	7314150355839	1	219,84	512
NSB224-32	7314150355846	1	247,84	512
NSB224-34	7314150355853	1	266,69	512
NSB224-36	7314150355860	1	286,50	512
NSB224-38	7314150355877	1	305,84	512
NSB224-41	7314150355884	1	336,26	512
NSB224-46	7314150355891	1	397,62	513
NSB224-50	7314150355907	1	435,79	513
NSB228-22	7314150356126	1	170,16	513
NSB228-24	7314150356133	1	197,02	513
NSB228-26	7314150356140	1	214,94	513
NSB228-27	7314150356157	1	232,86	513
NSB228-28	7314150356164	1	229,87	513
NSB228-29	7314150356171	1	268,66	513
NSB228-30	7314150356188	1	286,57	513
NSB228-31	7314150356195	1	270,15	513
NSB228-32	7314150356201	1	302,70	513
NSB228-34	7314150356218	1	358,22	513
NSB228-36	7314150356225	1	376,13	513
NSB228-38	7314150356232	1	394,04	513
NSB228-41	7314150356249	1	403,00	513
NSB228-46	7314150356256	1	438,83	513
NSB228-50	7314150356263	1	465,66	513
NSB228-55	7314150356270	1	510,48	513
NSB228-60	7314150356287	1	635,85	513
NSB228-65	7314150356294	1	680,62	513
NSB228-70	7314150356300	1	752,27	513
NSB228-75	7314150356317	1	893,77	513
NSB228-80	7314150356324	1	949,28	513
NSB232-16-24	7314150356379	1	176,83	513
NSB232-24-16	7314150356393	1	213,47	513
NSB232-24-32	7314150356386	1	359,63	513
NSB232-32-24	7314150356409	1	348,10	513
NSB234-16-100	7314150356461	1	150,97	513
NSB234-16-200	7314150356478	1	167,22	513
NSB234-16-250	7314150356485	1	162,58	513
NSB234-24-200	7314150356492	1	234,57	513
NSB234-32-250	7314150356508	1	488,50	513
NSB236-16	7314150356553	1	224,16	514
NSB236-24	7314150356546	1	464,51	514
NSB236-32	7314150356560	1	707,32	514
NSB238-16-250	7314150356621	1	174,18	514
NSB238-24-250	7314150356614	1	267,09	514
NSB238-32-300	7314150356607	1	487,74	514
NSB240-16-230	7314150356744	1	219,21	514
NSB242-16	7314150356669	1	255,48	514
NSB242-24	7314150356676	1	510,96	514
NSB242-32	7314150356683	1	1.068,36	514
NSB243-16-400	7314150356706	1	339,22	514
NSB247-26	7314150356768	1	220,64	515
NSB248-16-52	7314150356720	1	110,66	515
NSB300-10-200	7314150317646	1	91,76	515
NSB300-10-300	7314150295845	1	98,82	515
NSB300-11-250	7314150317653	1	105,88	515
NSB300-11-300	7314150317660	1	112,93	515
NSB300-11-350	7314150295852	1	141,17	515
NSB300-12-400	7314150295869	1	169,41	515
NSB300-13-450	7314150295876	1	197,64	515
NSB300-3-50	7314150317530	1	21,00	515
NSB300-3-75	7314150317547	1	21,18	515
NSB300-4-75	7314150317554	1	26,83	515
NSB300-4.5-100	7314150295838	1	27,73	515
NSB300-4.5-50	7314150317561	1	23,99	515
NSB300-5-100	7314150317585	1	28,24	515
NSB300-5-75	7314150317578	1	29,46	515
NSB300-6-100	7314150285327	1	33,89	515



NSB300-6-125	7314150317592	1	33,89	515
NSB300-6-150	7314150317608	1	41,22	515
NSB300-7-150	7314150317615	1	41,22	515
NSB300-8-150	7314150285334	1	42,36	515
NSB300-8-200	7314150317622	1	65,25	515
NSB300-9-250	7314150317639	1	77,29	515
NSB301-10-200	7314150317974	1	81,27	516
NSB301-10-300	7314150317981	1	100,13	516
NSB301-3-50	7314150317905	1	30,83	516
NSB301-4-100	7314150317912	1	40,19	516
NSB301-4-150	7314150317929	1	52,92	516
NSB301-5-100	7314150317936	1	49,27	516
NSB301-5-200	7314150317943	1	70,60	516
NSB301-6-100	7314150317950	1	70,60	516
NSB301-8-150	7314150317967	1	84,70	516
NSB302-0-50	7314150295883	1	31,06	516
NSB302-1-100	7314150285341	1	31,06	516
NSB302-2-125	7314150285358	1	33,89	516
NSB302-3-150	7314150295890	1	49,43	516
NSB302-4-300	7314150295906	1	77,66	516
NSB304-0-50	7314150295913	1	31,06	516
NSB304-1-100	7314150295920	1	31,06	516
NSB304-2-125	7314150295937	1	33,89	516
NSB304-3-150	7314150295944	1	42,36	516
NSB304-4-300	7314150295951	1	77,66	516
NSB320-10	7314150318070	1	67,68	516
NSB320-2	7314150317998	1	43,91	516
NSB320-3	7314150318001	1	44,44	516
NSB320-4	7314150318018	1	45,14	516
NSB320-5	7314150318025	1	47,10	516
NSB320-6	7314150318032	1	49,12	516
NSB320-7	7314150318049	1	54,38	516
NSB320-8	7314150318056	1	57,07	516
NSB320-9	7314150318063	1	63,04	516
NSB400-160	7314150295968	1	169,41	516
NSB400-180	7314150285365	1	183,53	516
NSB400-200	7314150295975	1	197,64	516
NSB402-160	7314150295982	1	206,09	517
NSB402-200	7314150295372	1	253,86	517
NSB403-160	7314150318179	1	249,90	517
NSB403-180	7314150318186	1	262,67	517
NSB404-160	7314150318223	1	155,30	517
NSB405-160	7314150318230	1	270,97	517
NSB406-160	7314150295999	1	169,41	517
NSB406-180	7314150318254	1	197,20	517
NSB406-200	7314150296002	1	197,64	517
NSB407-160	7314150318285	1	372,09	518
NSB408-250	7314150285389	1	248,61	518
NSB408-300	7314150318308	1	301,06	518
NSB411-200	7314150318315	1	363,70	518
NSB412-200	7314150318346	1	141,17	518
NSB413-180	7314150318353	1	371,90	518
NSB413-200	7314150318360	1	371,90	518
NSB500-1000-FB	7314150324828	1	171,74	519
NSB500-1500-FB	7314150324835	1	247,52	519
NSB500-2000	7314150324781	1	325,15	518
NSB500-2000-FB	7314150324842	1	327,33	519
NSB500-2500	7314150324798	1	383,22	518
NSB500-2500-FB	7314150324859	1	420,27	519
NSB500-3000	7314150324804	1	452,90	518
NSB500-3000-FB	7314150324866	1	499,08	519
NSB500-3500-FB	7314150324873	1	630,40	519
NSB500-4000	7314150324811	1	454,59	518
NSB502-1000-FB	7314150316922	1	164,44	519
NSB502-10000-FB	7314150316991	1	1.444,87	519
NSB502-12000-FB	7314150318414	1	1.971,63	519
NSB502-1500-FB	7314150318421	1	219,25	519
NSB502-2000-FB	7314150316939	1	301,48	519
NSB502-2500-FB	7314150316946	1	383,69	519
NSB502-3000-FB	7314150316953	1	465,91	519
NSB502-450-FB	7314150324880	1	117,78	519
NSB502-4500-FB	7314150316960	1	616,65	519
NSB502-5000-FB	7314150316977	1	671,46	519
NSB502-6800-FB	7314150318452	1	931,82	519
NSB502-8000-FB	7314150316984	1	986,63	519
NSB504-100-FB	7314150317004	1	63,53	519
NSB504-1000-FB	7314150317059	1	209,85	519
NSB504-1500-FB	7314150317066	1	283,93	519
NSB504-200-FB	7314150317011	1	86,40	519
NSB504-2000-FB	7314150317073	1	343,18	519
NSB504-300-FB	7314150317028	1	106,14	519
NSB504-500-FB	7314150317035	1	133,32	519
NSB504-800-FB	7314150317042	1	172,82	519
NSB506-300	7314150324897	1	74,08	519
NSB506-300-FB	7314150318490	1	75,50	520
NSB506-450	7314150324903	1	98,75	519
NSB506-450-FB	7314150318483	1	100,65	520
NSB506-700	7314150324910	1	138,88	519
NSB506-700-FB	7314150317080	1	126,98	520
NSB506-900	7314150324927	1	185,15	519
NSB506-900-FB	7314150317097	1	193,22	520
NSB508-500-FB	7314150318513	1	111,13	520
NSB508-700-FB	7314150318520	1	131,33	520
NSB512-200-FB	7314150318643	1	94,97	520
NSB512-400-FB	7314150318636	1	119,20	520
NSB512-600-FB	7314150318629	1	131,33	520



NSB512-900-FB	7314150318605	1	185,81	520
NSB600-100-50	7314150317110	1	49,38	520
NSB600-135-50	7314150317127	1	93,82	520
NSB600-150-25	7314150317134	1	44,45	520
NSB600-150-30	7314150317141	1	47,27	520
NSB600-150-40	7314150317158	1	51,09	520
NSB600-150-50	7314150317165	1	83,95	520
NSB600-180-13	7314150317172	1	38,11	520
NSB600-180-32	7314150317189	1	56,78	520
NSB600-180-50	7314150317196	1	125,92	520
NSB600-200-20	7314150317202	1	111,11	520
NSB600-200-30	7314150317219	1	135,79	520
NSB600-200-40	7314150317226	1	211,26	520
NSB600-200-50	7314150317233	1	99,02	520
NSB600-230-40	7314150317240	1	143,20	520
NSB600-250-40	7314150317257	1	222,20	520
NSB600-300-50	7314150317264	1	434,54	520
NSB600-80-13	7314150317103	1	13,34	520
NSB602-460	7314150324934	1	299,78	521
NSB602-600	7314150324941	1	136,94	521
NSB602-760	7314150324958	1	621,79	521
NSB602-900	7314150324965	1	737,13	521
NSB604-150	7314150324972	1	128,70	521
NSB604-200	7314150324989	1	172,62	521
NSB604-300	7314150324996	1	343,17	521
NSB606-150	7314150325009	1	87,03	521
NSB606-200	7314150325016	1	111,91	521
NSB606-250	7314150325023	1	151,28	521
NSB606-300	7314150325030	1	205,17	521
NSB606-400	7314150325047	1	264,11	521
NSB608-100	7314150325054	1	68,61	521
NSB700-300	7314150296255	1	175,31	522
NSB702-200	7314150296262	1	85,37	522
NSB704-225	7314150296279	1	189,99	522
NSB706-50	7314150296286	1	120,18	522
NSB706-80	7314150296293	1	184,41	522
NSB708-360	7314150296309	1	222,15	522
NSB710-450	7314150296316	1	472,36	523
NSB800-1100	7314150325061	1	273,93	523
NSB800-1700	7314150325078	1	400,46	523
NSB800-2000	7314150325085	1	477,86	523
NSB802-290	7314150325092	1	426,73	523
NSB810-100	7314150318650	1	1.270,80	523
NSB810-150	7314150318667	1	1.410,80	523
NSB810-200	7314150318674	1	1.507,39	523
NSB810-350	7314150318681	1	2.540,71	523
P-HB	7314150125272	25	0,77	542
P-MEC	7314150374342	24	5,53	543
P-MEC-LEAD	7314150374359	12	4,01	543
P1-20	7311518044572	5	42,36	621
P1-23	7311518332501	5	47,66	621
P108-20-F	7311518275518	2	31,82	621
P108-23-F	7311518275525	2	36,37	621
P11	7311518009076	6	40,53	632
P110-20-F	7311518275532	2	30,68	621
P110-23-F	7311518275549	2	34,78	621
P114-SL-40	7311518301149	2	76,27	624
P114-SL-50	7311518301156	2	77,85	624
P114-SL-60	7311518301163	2	84,78	624
P116-SL-40	7311518301101	2	87,96	625
P116-SL-50	7311518301118	2	92,11	625
P116-SL-60	7311518301125	2	94,98	625
P116-SL-70	7311518301132	2	97,90	625
P121-18-F	7311518275662	6	23,30	622
P121-20-F	7311518275631	6	24,43	622
P121-23-F	7311518275648	6	25,57	622
P123-19-BULK30	7311518218218	30	11,45	624
P126-19-F	7311518275297	6	17,50	622
P126-22-F	7311518275303	6	22,50	622
P127-19-BULK30	7311518199333	30	11,26	624
P128-19	7311518160814	6	14,68	624
P128-19-BULK30	7311518172329	30	11,56	624
P129-19-BULK30	7311518172336	30	12,55	624
P130-F	7311518333980	6	36,08	625
P138-22-BULK6	7311518328696	6	29,87	622
P138-22-F	7311518301279	6	42,97	622
P140-F	7311518275372	6	45,77	625
P16-40W	7311518013479	2	76,09	624
P16-50-F	7311518043049	2	75,91	624
P16-60-F	7311518301286	2	91,90	624
P160-SL-60	7311518276461	2	94,97	624
P160-SL-75	7311518301170	2	102,45	625
P160-SL-90	7311518301187	1	108,63	625
P173-SL-85	7311518301194	1	116,25	625
P19-80-F	7311518334703	1	106,04	625
P20	7311518275365	1	167,73	625
P241	7311518009281	6	48,11	632
P262	7311518008956	5	12,68	617
P263	7311518299286	10	16,32	616
P264	7311518299262	10	18,36	616
P266	7311518299279	10	16,45	616
P267	7311518299293	10	16,25	617
P268	7311518299309	10	16,91	616
P269	7311518299316	10	16,91	616
P270	7311518299323	10	13,28	617
	7311518299330	10	15,77	617





P272	7311518299354	5	20,87	616
P274	7311518299347	5	20,28	616
P276	7311518299361	5	20,81	617
P277	7311518299378	5	21,29	616
P278	7311518299385	5	21,16	616
P280-SL-60	7311518346508	2	67,90	625
P280-SL-80	7311518301330	2	73,87	625
P3-20-F	7311518275259	2	60,85	621
P3-23-F	7311518275266	2	63,24	621
P34-27A-F	7311518275464	2	36,37	627
P34-37	7311518002787	2	68,18	627
P5-23-F	7311518275280	2	71,15	621
P51-F	7311518275426	2	51,71	630
P51-SL	7311518301217	2	51,71	630
P51H-SL	7311518301224	2	54,55	630
P52-SL-20	7311518347307	2	88,60	631
P54-SL-25	7311518301231	2	106,82	631
P54H-SL-25	7311518301255	2	106,81	631
P57-25-F	7311518301293	4	39,77	630
P59-25-F	7311518275655	6	33,17	631
P6160	7314150115075	10	75,00	647
P64-20-BULK12	7311518288204	12	39,68	622
P74	7311518124076	40	61,63	632
P75	7311518124083	48	60,53	632
PAGS-2.0	7311518327835	1	31,19	601
PAGS-2.0-900FG	7311518292355	1	74,97	601
PBB-8	7314150399376	8	24,10	542
PBS-700	7314150341689	6	24,63	542
PC-10-DTF	7311518263560	10	27,46	566
PC-10-DTL	7311518263553	10	17,96	566
PC-10-DTR	7311518263546	10	17,96	566
PC-11-19-PS	7311518285548	4	45,87	565
PC-11-19-PS-B	7311518285555	10	31,31	565
PC-12-14-PS	7311518285562	4	41,58	565
PC-12-14-PS-B	7311518285579	10	29,00	565
PC-12-COM	7311518263454	4	21,57	560
PC-12-TEN	7311518263447	4	31,07	564
PC-12-VEN	7311518263430	4	33,61	564
PC-15-GNP	7311518264307	4	28,50	560
PC-15-TBX	7311518263423	4	27,49	564
PC-16-DECO	7311518264987	4	28,50	561
PC-16-FILE-U7	7311518263461	4	19,34	562
PC-19-FILE-U7	7311518263478	4	20,68	562
PC-19-GT7	7311518263362	4	29,16	562
PC-19-GT9	7311518263379	4	29,16	564
PC-20-LAM	7311518258290	4	31,83	563
PC-20-PRC	7311518264291	4	48,19	564
PC-22-FILE-U7	7311518263485	4	22,00	562
PC-22-GT7	7311518263393	4	30,48	562
PC-22-GT9	7311518263409	4	30,48	564
PC-22-INS	7314150154500	4	31,02	561
PC-22-PLC	7314150276318	4	31,17	560
PC-24-FILE-U7	7311518263492	4	31,46	562
PC-24-PLS	7311518263508	4	36,93	560
PC-24-TIM	7311518263515	4	49,68	565
PC-6-DRY	7311518282004	6	22,95	560
PC-9-9/17-PS	7311518285586	4	42,15	565
PC-9-9/17-PS-B	7311518285593	10	31,58	565
PENCIL-200-DISP	7314150125227	1	181,35	543
PG-01-F	7311518329334	6	31,68	622
PG-03-L	7311518242855	2	32,68	622
PG-12-BULK15	7311518334628	15	13,97	622
PG-12-F	7311518328122	10	15,06	622
PG-18-45-F	7311518299033	2	39,77	625
PG-18-60-F	7311518288853	2	43,19	625
PG-19-F	7311518295936	2	58,73	625
PG-56-F	7311518288938	2	40,91	631
PG-57-F	7311518295943	2	43,19	631
PG-72	7311518242534	4	17,80	634
PH-6604-1P	7311518152819	15	3,11	35
PH-6604-25	7311518141134	25	1,99	35
PS501-1	7314150338283	1	197,83	654
PS501-2	7314150112432	1	220,37	654
PS501-3	7314150338290	1	227,89	654
PS501-4	7314150338306	1	234,15	654
PU-14	7314150016266	5	10,91	44
PU-20	7314150016389	3	16,06	44
PU-22	7314150016426	3	21,50	44
PU-24	7314150016464	3	24,48	44
PU-6	7314150016105	5	7,30	44
PU-9	7314150016167	5	8,84	44
PX-L2	7311518233853	2	56,50	620
PX-L3	7311518233860	2	56,50	620
PX-M1	7311518233815	2	56,50	620
PX-M2	7311518233822	2	56,50	620
PX-M2-L	7311518240714	2	56,50	620
PX-M3	7311518233839	2	56,50	620
PX-S1	7311518233785	2	56,50	620
PX-S2	7311518233792	2	56,50	620
PXR-L2	7311518233914	2	81,81	620
PXR-M1	7311518233877	2	81,81	620
PXR-M2	7311518233884	2	81,81	620
PXR-M2-L	7311518240738	2	81,81	620
PXR-M3	7311518233891	2	81,81	620
PXR-S1	7311518240677	2	81,81	620
PXR-S2	7311518240684	2	81,81	620



PXR-S2-L	7311518346799	2	81,81	620
QC-115A	7314150460007	12	3,15	588
QC-115A-2P	7314150460021	6	6,28	588
QC-150A	7314150460045	6	7,08	588
QC-150A-2P	7314150460069	6	14,17	588
QC-300A	7314150401925	6	11,15	588
QC-300A-2P	7314150460090	4	22,30	588
QCB-1250	7314150135981	8	50,99	588
QCB-150	7314150135912	6	31,64	588
QCB-300	7314150135936	6	33,92	588
QCB-450	7314150135950	6	36,22	588
QCB-600	7314150135967	4	38,88	588
QCB-900	7314150135974	4	42,50	588
QCG-150	7314150135899	6	20,99	588
QCG-300	7314150135905	6	23,89	588
R1068	7311518044398	1	6,30	623
R1069P	7311518219574	12	5,30	623
R1071	7311518222918	14	10,64	624
R1075-BULK50	7311518220495	50	1,07	624
R1080P	7311518282479	1	6,22	623
R112PG	7311518010058	1	16,95	622
R113PG	7311518044374	30	18,29	623
R114PG	7311518010065	1	17,14	622
R114V	7311518042660	25	32,96	625
R114V-BULK28	7311518177539	28	22,84	625
R115V	7311518243210	8	32,87	625
R115V-BULK14	7311518288341	14	26,73	625
R116V	7311518010164	1	29,73	625
R116V-BULK36	7311518159924	36	25,55	625
R119V	7311518029487	1	51,35	625
R122PG	7311518010072	30	18,00	622
R123PG	7311518044381	30	18,11	623
R124PG	7311518010089	30	18,29	622
R1269P-BULK50	7311518240820	50	1,37	621
R133PG	7311518328252	1	12,83	629
R137E	7311518011574	30	20,72	628
R142P	7311518010126	24	7,71	623
R143PV	7311518010133	1	7,04	626
R143PVCB	7311518255633	1	7,67	626
R144PV	7311518291075	24	7,10	626
R146VC	7311518046545	22	8,22	631
R146VS	7311518046538	24	7,12	626
R146VS-BULK50	7311518159955	50	4,61	626
R147V	7311518044909	24	7,11	631
R148V	7311518223922	1	15,61	623
R1601	7311518044640	1	8,30	623
R160A	7311518201821	1	25,30	625
R160A-BULK28	7311518337216	28	19,88	625
R166V	7311518328085	22	9,51	626
R16V	7311518254513	1	33,05	625
R16V-BULK14	7311518288334	14	22,92	625
R181P	7311518296087	1	23,17	625
R185V	7311518331795	25	24,46	625
R201P	7311518219536	1	20,98	622
R201P-BULK80	7311518225209	80	12,45	622
R202P	7311518219550	1	21,55	623
R211P	7311518234027	1	20,06	620
R211P-BULK80	7311518252212	80	18,67	620
R214SL	7311518301392	1	25,80	626
R214V	7311518042745	1	27,93	626
R214V-BULK28	7311518177553	28	15,03	626
R215V	7311518243227	1	28,58	626
R216SL	7311518301408	8	27,06	626
R221P	7311518229412	1	7,47	622
R221P-BULK50	7311518240653	50	5,67	622
R223P	7311518237554	1	20,41	622
R223P-BULK80	7311518240646	80	17,00	622
R230P	7311518341503	10	23,98	628
R239P	7311518219567	1	8,50	623
R260A	7311518201814	16	24,93	626
R272H	7311518258016	1	9,98	626
R300P	7311518234034	1	19,70	620
R303P	7311518234157	1	21,03	620
R310-0	7314151829797	1	42,83	56
R310-1	7314151829803	1	48,30	56
R310-2	7314151829810	1	71,58	56
R310-3	7314151829827	1	91,48	56
R312V	7311518235420	1	15,02	626
R315V	7311518243234	1	12,67	626
R318V	7311518029500	1	13,58	626
R328V	7311518296056	22	6,67	626
R335V	7311518331801	12	10,62	626
R337E	7311518011598	1	10,38	629
R341P	7311518011529	12	5,05	623
R372H	7311518235406	1	19,66	626
R373A	7311518334710	25	32,76	625
R403P	7311518234164	1	21,25	620
R415V	7311518243241	1	9,92	626
R4230	7311518341510	10	7,15	628
R427AE	7311518176068	18	9,33	629
R434P	7311518223885	1	6,67	623
R434P-BULK50	7311518169916	50	1,93	623
R437E	7311518011611	18	10,38	629
R438P	7311518229429	1	6,31	623
R438P-BULK50	7311518240660	50	1,94	623
R440V	7311518254544	22	7,65	626

			€	
R444V	7311518243340	22	5,94	631
R463P	7311518223908	1	7,38	623
R472H	7311518334840	30	16,71	626
R474P	7311518011536	1	4,88	623
R478P	7311518275600	1	9,00	624
R480P	7311518282486	1	7,28	624
R500P	7311518234041	40	19,78	620
R503P	7311518234171	1	19,28	620
R515VS	7311518046514	22	5,29	631
R516V	7311518200824	22	4,45	631
R519V	7311518029517	1	10,11	626
R600P	7311518240783	1	19,61	620
R603P	7311518240790	1	18,77	620
R615V	7311518010119	1	9,38	626
R619V	7311518029494	1	31,72	626
R660V	7311518210281	24	8,78	626
R6725MK	7314151088354	1	259,10	69
R6725ZK	7314151784898	1	248,84	69
R680V	7311518042752	1	24,21	626
R6810M-10	7314150195152	5	13,57	78
R6810M-3,4	7314150195077	5	11,56	78
R6810M-4	7314150195084	5	11,56	78
R6810M-4,5	7314150195091	5	11,56	78
R6810M-5	7314150195107	5	11,81	78
R6810M-6	7314150195114	5	11,81	78
R6810M-7	7314150195121	1	12,07	78
R6810M-8	7314150195138	5	12,75	78
R6810M-9	7314150195145	5	12,75	78
R6810Z-1/4	7314150429448	1	11,82	79
R6810Z-3/16	7314150429387	1	11,82	79
R6810Z-3/8	7314150429394	1	14,38	79
R6810Z-5/16	7314150429400	1	14,38	79
R6810Z-7/32	7314150429417	1	11,82	79
R6822Z	7314150429424	5	14,39	79
R6950	7314151089658	1	104,43	84
R6964A	7314150195176	1	6,40	79
R6967	7314150195169	5	13,51	79
R716VCB	7311518255497	40	27,80	626
R772V	7311518301385	14	6,51	626
R773V	7311518324414	1	6,12	626
R775V	7311518331818	1	10,16	626
R776V	7311518334734	1	18,50	626
R801P	7311518234126	1	38,08	620
R802P	7311518234133	1	38,37	620
R803P	7311518234140	1	38,46	620
R804P	7311518240806	1	33,30	620
R811P	7311518234058	1	26,00	620
R812P	7311518234065	1	24,59	620
R813P	7311518234072	1	24,60	620
R815P	7311518240752	1	25,66	620
R900P	7311518234188	1	8,00	620
R901P	7311518234195	30	7,17	620
R902P	7311518234201	24	6,45	621
R903P	7311518234218	1	5,26	621
R904P	7311518234225	1	7,36	621
R905P	7311518234232	1	5,87	621
R905P-BULK50	7311518252250	50	2,32	621
R906P	7311518234249	1	5,87	621
R906P-BULK50	7311518252267	50	2,46	621
R907P	7311518234256	1	6,10	621
RAIL-10	7314150511075	10	2,84	82
RAIL-340	73141503003645	3	3,21	82
RAIL-8	7314150511051	10	2,58	82
RAUNI	7311518339289	6	17,95	627
RB-SET-AL06-5P	7314150501489	1	352,31	148
RB-SET-M06X-10P	7314150501557	1	380,50	148
RB-SET1-M06X-5P	7314150501588	1	200,93	148
RB-SET2-M06X-5P	7314150501618	1	159,25	148
RBCP	7311518339272	10	10,95	628
RBCP230	7311518341558	12	10,58	628
RCAM30	7311518346959	20	4,34	628
RCAM36	7311518346973	20	4,34	628
RD1M	7311518341534	15	13,17	628
RD7M	7311518341541	20	24,58	629
RPL230G	7311518341527	8	25,22	629
RT821P	7311518242237	1	49,92	620
RT822P	7311518234102	1	47,89	620
RT823P	7311518234119	6	55,10	620
RT824P	7311518240776	1	65,33	620
RT825P	7311518347147	6	49,94	620
RX 01	7314150103263	1	6,29	649
RX 7390	7314150342587	10	63,09	651
RX 7392	7314150342594	10	63,09	651
RX 7490	7314150103195	10	68,31	650
RX 7590	7314150103201	10	68,62	650
RX 7890	7314150103218	10	72,15	651
RX 7891	7314150103225	10	67,19	651
RX 7892	7314150103232	10	80,54	651
RX 7893	7314150103249	10	74,27	651
RX 7894	7314150212101	10	66,73	652
RX 8130	7314150103003	10	77,30	644
RX 8131	7314150103010	10	82,80	644
RX 8132	7314150103027	10	95,60	644
RX 8137	7314150392926	10	77,50	645
RX 8140	7314150103034	10	68,20	644

			€	
RX 8141	7314150103041	10	74,78	644
RX 8142	7314150103058	10	79,29	644
RX 8142PS	7314150349371	10	73,90	649
RX 8143	7314150103065	10	82,98	644
RX 8144	7314150103072	10	81,27	644
RX 8145	7314150103089	10	81,23	644
RX 8146	7314150103096	10	68,31	645
RX 8147	7314150103102	10	83,57	645
RX 8147PS	7314150425402	10	93,60	649
RX 8148	7314150103119	10	93,25	645
RX 8149	7314150103126	10	171,21	648
RX 8150	7314150103133	10	80,23	644
RX 8151	7314150103140	10	87,12	644
RX 8152	7314150103157	10	86,74	644
RX 8153	7314150412976	10	33,55	644
RX 8154	7314150351435	10	33,55	644
RX 8156	7314150411528	10	61,11	645
RX 8157	7314150383733	10	74,80	645
RX 8158	7314150117130	10	169,45	645
RX 8160	7314150111534	10	76,25	644
RX 8161	7314150111541	10	92,48	644
RX 8161PS	7314150410750	10	52,26	649
RX 8162	7314150111558	10	101,46	644
RX 8164	7314150116270	10	113,38	644
RX 8165	7314150116287	10	116,12	644
RX 8167	7314150383726	10	128,14	645
RX 8168	7314150115495	10	209,74	645
RX 8211	7314150103188	10	136,03	646
RX 8247	7314150103164	10	84,26	646
RX 8248	7314150103171	10	149,17	647
RX112A-0.3	7314150411498	5	151,41	653
RX112A-1.0	7314150384020	10	151,41	653
RX112A-1.5	7314150352425	10	151,41	653
RX112A-2.0	7314150384037	10	200,92	653
RX304D	7314150476701	5	150,02	653
RX331A	7314150434725	10	77,50	653
RX8133	7314150476749	10	66,95	644
RX8134	7314150476756	10	66,95	644
RX8135	7314150476763	10	66,95	644
RX8136	7314150476770	10	66,95	645
RX8137MX	7314150358519	10	77,50	645
RX8138	7314150346561	10	77,50	645
RX8138MX	7314150349395	10	59,63	645
RX8140M2	7314150476787	10	116,21	649
RX8140PS	7314150360635	10	116,21	649
RX8141PS	7314150349432	10	39,10	649
RX8143PS	7314150360642	10	70,13	649
RX8150M2	7314150476794	10	48,32	649
RX8150PS	7314150358502	10	92,13	649
RX8155	7314150374014	10	131,14	644
RX8160BPS	7314150360048	10	66,66	650
RX8160M2	7314150476800	10	183,94	649
RX8163	7314150476817	10	57,59	644
RX8166	7314150476558	10	57,59	645
RX8233A	7314150436279	10	198,15	648
RX8234A	7314150436286	10	185,76	648
RX8237A	7314150436293	10	185,75	648
S0810L	7314150256594	20	31,84	63
S103	7314150257119	2	289,07	62
S103-CASE	7314150321261	1	62,10	102
S106	7314150103997	2	305,91	62
S108	7314150122257	2	306,94	62
S108-CASE	7314150349319	1	60,01	102
S1214L	7314150256600	10	58,25	69
S137	7314150450503	2	418,85	63
S138	7314150195022	2	324,45	63
S140T	7314150125203	1	70,90	70
S140T-R	7314150136353	10	43,26	70
S160	7314150104031	6	49,44	64
S160AF	7314150137510	6	49,44	64
S1612L	7314150256617	4	71,63	72
S18HEX	7314150412457	4	98,67	72
S18TORX	7314150412464	4	101,00	72
S240	7314150104017	4	123,95	72
S240AF	7314150111077	4	123,95	72
S240AF-CASE	7314150187317	1	44,82	102
S290	7314153000859	6	71,58	64
S330	7314150104024	6	78,26	69
S330-CASE	7314150136223	1	31,01	102
S330AF	7314150137503	6	78,26	70
S330L	7314150256587	4	114,01	69
S330L-CASE	7311518337674	1	43,44	102
S350AF	7314150137527	2	192,56	73
S380	7314150168934	4	113,16	70
S400	7314150111053	2	183,64	72
S400-CASE	7314150187300	1	50,57	102
S410	7314153019370	2	126,69	62
S410-CASE	7314150321223	1	50,58	102
S460	7314150111060	6	110,91	64
S460-CASE	7314150321209	1	44,83	102
S4RM-12-15	7314150179954	1	31,14	47
S4RM-16-19	7314150179961	1	37,52	47
S4RM-21-27	7314150179978	1	72,48	47
S4RM-30-36	7314150179985	1	133,41	47
S4RM-4-7	7314150179930	1	20,85	47
S4RM-8-11	7314150179947	1	23,06	47



S4RM/3T



S4RM/3T	7314150117406	20	94,49	47
S4RM/4T	7314150179916	1	154,46	48
S4RM/5T	7314150179923	1	311,27	48
S530T	7314150169122	4	196,41	70
S560	7314150122264	4	118,45	63
S560-CASE	7314150321216	1	44,50	102
S800	7314150165599	2	290,56	62
S81MIX	7314150180127	2	221,45	62
S81MIX-CASE	7314150321247	1	60,67	102
S87+7	7314150103980	2	262,65	62
S910	7314150104000	2	218,36	62
S910AF	7314150137541	2	218,36	63
S95	7314150409167	2	235,09	62
S9HEX	7314150412433	10	49,44	72
S9TORX	7314150412440	10	49,44	72
SB-2058/S26	7314151849498	1	35,15	168
SB-2448	7314150136056	12	30,67	572
SB-2449	7314150194049	10	27,49	572
SB-3732-2-125	7314151847869	60	5,94	608
SB-3732-2.5-125	7314151847876	60	5,94	608
SB-3732-3.2-125	7314151847883	60	5,94	608
SB-3732-4-125	7314151847890	1	5,94	608
SB-3734N-10-150	7314151848101	1	8,36	607
SB-3734N-2-150	7314151847968	1	6,92	607
SB-3734N-3-150	7314151847975	1	6,92	607
SB-3734N-4-150	7314151847982	60	7,12	607
SB-3734N-5-150	7314151847999	1	7,12	607
SB-3734N-6-150	7314151848071	60	8,36	607
SB-3734N-7-150	7314151848088	1	8,36	607
SB-3734N-8-150	7314151848095	1	8,36	607
SB-3735N-2-100	7314151847906	1	6,33	606
SB-3735N-4-120	7314151847913	60	6,93	606
SB-3735N-5-120	7314151847920	1	7,74	606
SB-3735N-6-150	7314151847937	1	8,36	606
SB-3735N-8-150	7314151847944	1	8,36	606
SB-3740-125	7314150115990	87	11,52	604
SB-3740-150	7314150116003	25	13,11	604
SB-3740-175	7314150116010	25	14,67	604
SB-3740-200	7314150116027	25	15,27	604
SB-3740-250	7314150116034	25	16,11	604
SB-3740-300	7314150116041	25	16,91	604
SB-9526/S6	7314150154234	20	47,03	154
SB111M-10	7314151839864	1	8,55	40
SB111M-11	7314151839871	1	9,20	40
SB111M-12	7314151839888	1	9,64	40
SB111M-13	7314151839895	1	10,11	40
SB111M-14	7314151839901	1	10,51	40
SB111M-15	7314151839918	1	10,83	40
SB111M-16	7314151839925	1	11,64	41
SB111M-17	7314151839932	1	12,14	41
SB111M-18	7314151839949	1	12,71	41
SB111M-19	7314151839956	1	14,41	41
SB111M-20	7314151839963	1	14,52	41
SB111M-21	7314151839970	1	16,49	41
SB111M-22	7314151839987	1	16,61	41
SB111M-23	7314151839994	1	17,54	41
SB111M-24	7314151840006	1	18,32	41
SB111M-25	7314151840013	1	19,77	41
SB111M-26	7314151840020	1	19,25	41
SB111M-27	7314151840037	1	21,55	41
SB111M-28	7314150432103	1	26,58	41
SB111M-29	7314151840051	1	28,79	41
SB111M-30	7314151840068	1	30,83	41
SB111M-32	7314151840075	1	34,31	41
SB111M-5.5	7314151839819	1	6,80	40
SB111M-6	7314151839826	1	7,05	40
SB111M-7	7314151839833	1	7,10	40
SB111M-8	7314151839840	1	7,27	40
SB111M-9	7314151839857	1	8,49	40
SB141.007.075	7314150282753	1	8,99	206
SB141.008.075	7314150282760	1	9,02	206
SB141.009.075	7314150282777	1	9,04	206
SB141.010.075	7314150282784	1	9,07	206
SB141.015.100	7314150282791	1	9,13	206
SB141.020.100	7314150282807	1	9,17	206
SB141.025.125	7314150282814	1	9,53	206
SB141.027.125	7314150282821	1	9,66	206
SB141.030.150	7314150282838	1	10,90	206
SB141.040.150	7314150282845	1	12,60	206
SB142.000.075	7314150282579	1	7,55	496
SB142.001.080	7314150282586	1	8,89	496
SB142.002.100	7314150282593	1	10,92	496
SB142.003.150	7314150282609	1	16,05	496
SB143.020.100	7314150282852	1	4,75	206
SB143.025.100	7314150282869	1	4,83	206
SB143.030.100	7314150282876	1	4,88	206
SB143.040.100	7314150282883	1	5,44	206
SB143.050.100	7314150282890	1	6,58	206
SB143.060.125	7314150282906	1	7,46	206
SB143.080.150	7314150282913	1	10,34	206
SB144.001.100	7314150282951	1	7,64	206
SB144.002.125	7314150282968	1	8,15	206
SB144.003.150	7314150282975	1	8,46	206
SB145.006.100	7314150282920	1	7,34	207
SB146.006.100	7314150282937	1	7,66	207
SB148.001.080	7314150314577	1	10,53	496



SB148.002.100	7314150314584	1	11,17	496
SB149.001.080	7314150314591	1	10,73	496
SB149.002.100	7314150314607	1	11,43	496
SB150.010.100	7314150343492	1	7,05	496
SB150.015.125	7314150343515	1	7,10	496
SB150.020.125	7314150343577	1	7,21	496
SB150.025.150	7314150343584	1	7,44	496
SB190.040.075	7314150281985	1	5,45	204
SB190.040.100	7314150282098	1	5,51	204
SB190.055.100	7314150281992	1	6,78	204
SB190.055.125	7314150282005	1	6,91	204
SB190.065.125	7314150282012	1	8,34	204
SB190.065.150	7314150282029	1	9,37	204
SB190.080.150	7314150282036	1	10,21	204
SB190.080.175	7314150282043	1	10,47	204
SB190.100.200	7314150282050	1	13,53	204
SB190.120.250	7314150282067	1	17,34	204
SB190.140.250	7314150282074	1	18,42	204
SB191.025.075	7314150282081	1	4,13	204
SB191.030.075	7314150282108	1	4,24	204
SB191.030.100	7314150282111	1	4,50	204
SB191.030.200	7314150282128	1	6,76	204
SB191.035.100	7314150282135	1	4,63	204
SB191.040.100	7314150282142	1	5,15	204
SB191.040.125	7314150282159	1	5,60	204
SB191.040.250	7314150282166	1	7,98	204
SB191.055.125	7314150282173	1	6,90	204
SB191.055.150	7314150282180	1	7,62	204
SB191.055.300	7314150282197	1	10,02	204
SB191.065.150	7314150282203	1	8,84	204
SB191.065.300	7314150282210	1	11,38	204
SB192.000.075	7314150282357	1	5,41	205
SB192.000.200	7314150282364	1	7,47	205
SB192.001.100	7314150282371	1	6,47	205
SB192.001.250	7314150282388	1	9,31	205
SB192.002.125	7314150282395	1	7,87	205
SB192.002.300	7314150282401	1	11,52	205
SB192.003.150	7314150282418	1	11,70	205
SB192.004.200	7314150282425	1	15,92	205
SB193.000.075	7314150282456	1	6,30	205
SB193.001.100	7314150282463	1	6,97	205
SB193.002.125	7314150282470	1	8,34	205
SB193.003.150	7314150282487	1	12,30	205
SB193.004.200	7314150282494	1	16,83	205
SB194.004.075	7314150282616	1	7,34	206
SB194.005.075	7314150282623	1	7,16	206
SB194.006.075	7314150282630	1	6,67	206
SB194.007.075	7314150282647	1	6,70	206
SB194.008.075	7314150282654	1	6,72	206
SB194.009.075	7314150282661	1	6,75	206
SB194.010.075	7314150282678	1	6,76	206
SB194.015.100	7314150282685	1	6,90	206
SB194.020.100	7314150282692	1	6,97	206
SB194.025.125	7314150282708	1	7,38	206
SB194.027.125	7314150282715	1	7,55	206
SB194.030.150	7314150282722	1	8,88	206
SB194.040.150	7314150282739	1	10,55	206
SB194.045.150	7314150282746	1	11,27	206
SB195.001.025	7314150282432	1	6,67	205
SB195.002.025	7314150282449	1	6,67	205
SB195.006.050	7314150289516	1	6,67	207
SB195.040.025	7314150282227	1	5,15	204
SB195.050.025	7314150282234	1	6,41	204
SB195.060.025	7314150282241	1	6,67	204
SB195.901.025	7314150282500	1	7,01	205
SB195.902.025	7314150282517	1	7,43	205
SB1952M-10	7314150105205	1	11,37	43
SB1952M-12	7314150105229	1	12,72	43
SB1952M-13	7314150105236	1	13,69	43
SB1952M-14	7314150105243	1	13,81	43
SB1952M-17	7314150105274	1	17,87	43
SB1952M-19	7314150105298	1	20,77	43
SB1952M-24	7314150105342	1	28,48	43
SB1952M-7	7314150105441	1	10,36	43
SB1952M-8	7314150105458	1	10,21	43
SB196.025.075	7314150282258	1	6,73	495
SB196.030.100	7314150282265	1	6,63	495
SB196.035.100	7314150282272	1	6,90	495
SB196.040.100	7314150282289	1	7,88	495
SB196.055.125	7314150282296	1	9,27	495
SB196.065.150	7314150282302	1	11,64	495
SB196.080.175	7314150282326	1	12,79	495
SB196.100.200	7314150282333	1	16,49	495
SB196.120.200	7314150282340	1	19,05	495
SB197.000.075	7314150282524	1	6,88	496
SB197.001.080	7314150282531	1	8,34	496
SB197.002.100	7314150282548	1	10,52	496
SB197.003.150	7314150282555	1	13,29	496
SB197.004.200	7314150282562	1	19,29	496
SB198.040.125	7314150282982	1	10,28	207
SB198.045.125	7314150282999	1	10,28	207
SB198.050.150	7314150283002	1	10,83	207
SB198.055.150	7314150283019	1	10,83	207
SB198.060.150F	7314150283026	1	11,27	207
SB198.060.150F	7314150283033	1	16,10	207
SB198.070.150	7314150283040	1	11,80	207



SB198.070.150F	7314150283057	1	16,59	207
SB198.080.150	7314150283064	1	14,04	207
SB198.080.150F	7314150283071	1	17,66	207
SB198.090.150	7314150283088	1	14,31	207
SB198.100.150	7314150283095	1	14,71	207
SB198.110.150	7314150283101	1	15,10	207
SB198.120.150	7314150283118	1	16,96	207
SB198.130.150	7314150283125	1	17,46	207
SB198.140.150	7314150283132	1	18,91	207
SB199.055.125	7314150283149	1	12,04	496
SB199.060.125	7314150283156	1	13,04	496
SB199.070.125	7314150283163	1	13,91	496
SB199.080.125	7314150283170	1	15,29	496
SB199.090.125	7314150283187	1	16,94	496
SB199.100.125	7314150283194	1	18,63	496
SB199.110.125	7314150283200	1	20,29	496
SB199.120.125	7314150287765	1	22,57	496
SB199.130.125	7314150287796	1	24,97	496
SB2446-EL	7314150312207	10	9,72	584
SB2446-LAP	7314150539475	10	10,30	583
SB27M-10-11	7314150180851	10	15,39	58
SB27M-12-13	7314150180868	10	18,00	58
SB27M-14-15	7314150180875	10	19,95	58
SB27M-16-17	7314150180882	10	22,99	58
SB27M-18-19	7314150180899	10	27,22	58
SB27M-20-22	7314150180905	10	30,84	58
SB27M-21-23	7314150180912	5	34,18	58
SB27M-24-26	7314150180929	5	37,94	58
SB27M-6-7	7314150180837	10	14,42	58
SB27M-8-9	7314150180844	10	14,56	58
SB28M-10	7314150485987	10	13,79	56
SB28M-11	7314150486007	10	14,54	56
SB28M-12	7314150486021	10	15,39	56
SB28M-13	7314150486045	10	16,26	56
SB28M-14	7314150486052	10	19,05	56
SB28M-15	7314150486076	10	20,13	56
SB28M-16	7314150486090	5	21,20	56
SB28M-17	7314150486113	5	21,37	56
SB28M-18	7314150486137	5	26,43	56
SB28M-19	7314150486151	5	27,86	56
SB28M-20	7314150486854	4	29,79	56
SB28M-21	7314150486878	4	32,32	56
SB28M-22	7314150486892	4	37,45	56
SB28M-23	7314150486915	4	38,94	56
SB28M-24	7314150486939	4	41,23	56
SB28M-6	7314150486175	10	11,65	56
SB28M-7	7314150486199	10	12,10	56
SB28M-8	7314150486212	10	12,65	56
SB28M-9	7314150486236	10	13,10	56
SB3654BM-15	7314150270897	5	13,96	610
SB3654BM-20	7314150270903	5	14,83	610
SB3734BM-10	7314150271092	5	14,52	610
SB3734BM-3	7314150270996	5	12,68	610
SB3734BM-4	7314150271016	5	13,03	610
SB3734BM-5	7314150271030	5	13,43	610
SB3734BM-6	7314150271054	5	13,84	610
SB3734BM-8	7314150271078	5	14,10	610
SB3755BM-4	7314150270934	1	10,29	610
SB3755BM-6	7314150270958	5	11,45	610
SB6700SM-10	7314150104383	1	5,84	78
SB6700SM-11	7314150104390	1	5,84	78
SB6700SM-12	7314150104406	1	5,84	78
SB6700SM-13	7314150104413	1	5,84	78
SB6700SM-14	7314150104420	1	5,84	78
SB6700SM-4	7314150104307	1	5,84	78
SB6700SM-4.5	7314150104314	1	5,84	78
SB6700SM-5	7314150104321	1	5,84	78
SB6700SM-5.5	7314150104338	1	5,84	78
SB6700SM-6	7314150104345	1	5,84	78
SB6700SM-7	7314150104352	1	5,84	78
SB6700SM-8	7314150104369	1	5,84	78
SB6700SM-9	7314150104376	1	5,84	78
SB6700SZ-1/2	7314150240609	1	5,89	78
SB6700SZ-1/4	7314150240616	1	5,89	78
SB6700SZ-1/8	7314150412495	5	5,89	78
SB6700SZ-11/32	7314150240623	1	5,89	78
SB6700SZ-3/16	7314150240630	1	5,89	78
SB6700SZ-3/8	7314150240647	1	5,89	78
SB6700SZ-5/16	7314150240654	1	5,89	78
SB6700SZ-5/32	7314150240661	1	5,89	78
SB6700SZ-7/16	7314150240678	1	5,89	78
SB6700SZ-7/32	7314150240685	1	5,89	78
SB6700SZ-9/16	7314150240692	1	5,89	78
SB6700SZ-9/32	7314150240708	1	5,89	78
SB6700TORX-E10	7314150240715	1	7,55	78
SB6700TORX-E4	7314150240722	1	7,55	78
SB6700TORX-E5	7314150240739	1	7,55	78
SB6700TORX-E6	7314150240746	1	7,55	78
SB6700TORX-E7	7314150240753	1	7,55	78
SB6700TORX-E8	7314150240760	1	7,55	78
SB6709F-4.5	7314150240777	1	7,51	82
SB6709F-5.5	7314150240784	1	7,51	82
SB6709F-6.5	7314150240791	1	7,52	82
SB6709F-8	7314150240807	1	7,51	82
SB67M-3	7314150290055	1	3,50	83
SB6709M-4	7314150240821	1	7,41	83



SB6709M-5	7314150240838	1	7,41	83
SB6709M-6	7314150240845	1	7,41	83
SB6709M-8	7314150240852	1	7,41	83
SB6709PH-1	7314150240869	1	8,14	82
SB6709PH-2	7314150240876	1	8,14	82
SB6709PH-3	7314150240883	1	8,14	82
SB6709PZ-1	7314150240890	1	8,58	83
SB6709PZ-2	7314150240906	1	8,58	83
SB6709PZ-3	7314150240913	1	8,58	83
SB6709TORX-R-T10	7314150240975	1	9,46	83
SB6709TORX-R-T15	7314150240937	1	9,46	83
SB6709TORX-R-T20	7314150240944	1	9,46	83
SB6709TORX-R-T25	7314150240951	1	9,79	83
SB6709TORX-R-T8	7314150240968	1	9,46	83
SB6709TORX-T10	7314150240982	1	9,07	83
SB6709TORX-T15	7314150240999	1	9,07	83
SB6709TORX-T20	7314150241002	1	9,07	83
SB6709TORX-T25	7314150241019	1	9,33	83
SB6709TORX-T27	7314150241026	1	9,33	83
SB6709TORX-T30	7314150241033	1	9,33	83
SB6709TORX-T40	7314150241040	1	9,33	83
SB6709TORX-T8	7314150241057	1	9,07	83
SB6709TORX-T9	7314150241064	1	9,07	83
SB6950	7314150104987	1	41,54	84
SB6950RN	7314150104994	1	37,63	84
SB6954-5	7314150521188	10	12,31	80
SB6956	7314150241071	1	12,70	80
SB6958-6	7314150500833	1	43,05	80
SB6960	7314150104925	1	10,31	81
SB6960-3	7314150512225	1	12,23	81
SB6961	7314150104932	1	11,83	81
SB6962	7314150104949	1	13,93	81
SB6962L	7314150254743	1	30,54	81
SB6963	7314150241088	1	20,58	81
SB6966	7314150241095	1	24,31	81
SB6973A	7314150507214	1	5,85	82
SB6M-10-11	7314150105731	1	7,97	48
SB6M-12-13	7314150105762	1	9,08	48
SB6M-14-15	7314150105823	1	9,54	48
SB6M-16-17	7314150105847	1	10,57	48
SB6M-17-19	7314150189830	1	11,22	48
SB6M-18-19	7314150105878	1	11,34	48
SB6M-20-22	7314150105915	1	13,60	48
SB6M-21-23	7314150105922	1	14,71	48
SB6M-22-24	7314150105946	1	14,11	48
SB6M-24-26	7314150105953	1	16,72	48
SB6M-24-27	7314150105960	1	17,02	48
SB6M-25-28	7314150189847	1	18,10	48
SB6M-27-29	7314150189854	1	22,00	48
SB6M-30-32	7314150106011	1	24,56	48
SB6M-4-5	7314150106042	1	9,59	48
SB6M-6-7	7314150106073	1	8,06	48
SB6M-8-9	7314150106103	1	7,50	48
SB705.1/4.125	7314150283231	1	12,73	216
SB7400SM-10	7314150241101	1	6,79	85
SB7400SM-11	7314150241118	1	6,87	85
SB7400SM-12	7314150241125	1	6,98	85
SB7400SM-13	7314150241132	1	7,12	85
SB7400SM-14	7314150241149	1	7,56	85
SB7400SM-15	7314150241156	1	7,85	85
SB7400SM-16	7314150241170	1	8,23	85
SB7400SM-17	7314150241187	1	8,40	85
SB7400SM-18	7314150241194	1	8,60	85
SB7400SM-19	7314150241200	1	8,93	85
SB7400SM-20	7314150241217	1	9,14	85
SB7400SM-21	7314150241224	1	9,38	85
SB7400SM-22	7314150241231	1	9,53	85
SB7400SM-6	7314150241248	1	6,26	85
SB7400SM-7	7314150241255	1	6,26	85
SB7400SM-8	7314150241262	1	6,36	85
SB7400SM-9	7314150241279	1	6,58	85
SB7400TORX-E10	7314150241286	1	11,57	86
SB7400TORX-E11	7314150241293	1	11,57	86
SB7400TORX-E12	7314150241309	1	11,57	86
SB7400TORX-E14	7314150241316	1	12,56	86
SB7400TORX-E16	7314150241323	1	12,56	86
SB7400TORX-E18	7314150241330	1	13,15	86
SB7400TORX-E8	7314150241347	1	11,57	86
SB7409BH-10	7314150241354	1	14,68	90
SB7409BH-4	7314150241361	1	12,06	90
SB7409BH-5	7314150241378	1	12,06	90
SB7409BH-6	7314150241385	1	12,06	90
SB7409BH-8	7314150241392	1	13,03	90
SB7409F-10	7314150241408	1	7,24	89
SB7409F-6.5	7314150241415	1	7,24	89
SB7409F-8	7314150241422	1	7,24	89
SB7409M-10	7314150241439	1	12,29	90
SB7409M-3	7314150241446	1	11,29	90
SB7409M-4	7314150241453	1	11,29	90
SB7409M-5	7314150241460	1	11,29	90
SB7409M-6	7314150241477	1	11,29	90
SB7409M-7	7314150241484	1	11,29	90
SB7409M-8	7314150241491	1	12,29	90
SB7409PH-1	7314150241507	1	7,56	89
SB7409PH-2	7314150241514	1	7,56	89
SB7409PH-3	7314150241521	1	7,56	89



SB7409TORX-R-T27



SB7409TORX-R-T27	7314150241538	1	13,68	89
SB7409TORX-R-T30	7314150241545	1	13,68	89
SB7409TORX-R-T40	7314150241552	1	15,98	89
SB7409TORX-R-T45	7314150241569	1	16,25	89
SB7409TORX-R-T50	7314150241576	1	16,93	89
SB7409TORX-T20	7314150241583	1	12,40	89
SB7409TORX-T25	7314150241590	1	12,40	89
SB7409TORX-T25-L	7314150241606	1	19,73	90
SB7409TORX-T27	7314150241613	1	12,40	89
SB7409TORX-T30	7314150241620	1	12,40	89
SB7409TORX-T30-L	7314150241637	1	19,73	90
SB7409TORX-T40	7314150241644	1	14,86	89
SB7409TORX-T40-L	7314150241651	1	22,94	90
SB7409TORX-T45	7314150241668	1	14,86	89
SB7409TORX-T45-L	7314150241675	1	22,94	90
SB7409TORX-T50	7314150241682	1	14,86	89
SB7409TORX-T50-L	7314150241699	1	22,94	90
SB7750	7314150187850	1	58,94	88
SB7750RNR	7314153003966	1	53,14	88
SB7754	7314150250165	1	18,77	87
SB7756	7314150489176	1	18,93	87
SB7758-10	7314150500840	1	30,48	87
SB7759	7314150254859	1	41,27	87
SB7760	7314153003980	1	13,72	87
SB7761	7314150241705	1	16,19	87
SB7762	7314153004000	1	19,90	87
SB7764	7314150241729	1	12,97	88
SB7765	7314150241736	50	10,38	81
SB7766	7314150241743	1	30,00	87
SB7767	7314150254897	1	24,85	82
SB7773A	7314150516209	1	2,32	88
SB7800DM-10	7314150104451	1	7,58	92
SB7800DM-11	7314150104468	1	7,69	92
SB7800DM-12	7314150104475	1	8,06	92
SB7800DM-13	7314150104482	1	8,36	92
SB7800DM-14	7314150104499	1	8,73	92
SB7800DM-15	7314150104505	1	9,01	92
SB7800DM-16	7314150104512	1	9,18	92
SB7800DM-17	7314150104529	1	9,50	92
SB7800DM-18	7314150104536	1	9,50	92
SB7800DM-19	7314150104543	1	9,82	92
SB7800DM-20	7314150104550	1	10,05	92
SB7800DM-21	7314150104567	1	10,29	92
SB7800DM-22	7314150104574	1	10,60	92
SB7800DM-23	7314150104581	1	11,10	92
SB7800DM-24	7314150104598	1	11,81	92
SB7800DM-25	7314150104604	1	11,98	92
SB7800DM-26	7314150104611	1	12,20	92
SB7800DM-27	7314150104628	1	12,53	92
SB7800DM-28	7314150104635	1	13,35	92
SB7800DM-29	7314150104642	1	13,66	92
SB7800DM-30	7314150104659	1	13,81	92
SB7800DM-31	7314150471171	1	14,17	92
SB7800DM-32	7314150104666	1	14,32	92
SB7800DM-33	7314150240319	1	12,22	92
SB7800DM-34	7314150327607	1	17,16	92
SB7800DM-36	7314150104673	1	26,12	92
SB7800DM-8	7314150104437	1	7,58	92
SB7800DM-9	7314150104444	1	7,58	92
SB7800DZ-1	7314150234912	1	11,72	92
SB7800DZ-1.1/16	7314150240326	1	12,37	92
SB7800DZ-1.1/4	7314150240333	1	13,96	92
SB7800DZ-1.1/8	7314150240340	1	13,08	92
SB7800DZ-1.3/16	7314150240357	1	13,82	92
SB7800DZ-1.5/16	7314150240364	1	13,74	92
SB7800DZ-1/2	7314150234899	1	8,07	92
SB7800DZ-11/16	7314150234929	1	9,25	92
SB7800DZ-13/16	7314150234936	1	10,13	92
SB7800DZ-15/16	7314150234943	1	11,65	92
SB7800DZ-19/32	7314150240371	1	8,78	92
SB7800DZ-25/32	7314150240388	1	9,81	92
SB7800DZ-3/4	7314150234950	1	9,65	92
SB7800DZ-3/8	7314150234967	1	7,25	92
SB7800DZ-5/8	7314150234974	1	9,01	92
SB7800DZ-7/16	7314150234981	1	7,40	92
SB7800DZ-7/8	7314150234998	1	10,44	92
SB7800DZ-9/16	7314150235001	1	8,55	92
SB7800SM-10	7314150104703	1	7,72	91
SB7800SM-11	7314150104710	1	7,72	91
SB7800SM-12	7314150104727	1	8,06	91
SB7800SM-13	7314150104734	1	8,36	91
SB7800SM-14	7314150104741	1	8,73	91
SB7800SM-15	7314150104758	1	9,01	91
SB7800SM-16	7314150104765	1	9,18	91
SB7800SM-17	7314150104772	1	9,50	91
SB7800SM-18	7314150104789	1	9,50	91
SB7800SM-19	7314150104796	1	9,82	91
SB7800SM-20	7314150240395	1	9,77	91
SB7800SM-21	7314150104819	1	10,29	91
SB7800SM-22	7314150104826	1	10,60	91
SB7800SM-23	7314150104833	1	11,10	91
SB7800SM-24	7314150104840	1	11,81	91
SB7800SM-25	7314150104857	1	11,98	91
SB7800SM-26	7314150104864	1	12,20	91
SB7800SM-27	7314150104871	1	12,53	91
SB7800SM-28	7314150104888	1	13,35	91



SB7800SM-29	7314150240401	1	13,35	91
SB7800SM-30	7314150104895	1	13,81	91
SB7800SM-32	7314150104901	1	14,08	91
SB7800SM-33	7314150240418	1	13,59	91
SB7800SM-34	7314150235018	1	17,93	91
SB7800SM-36	7314150235025	1	25,12	91
SB7800SM-8	7314150104680	1	7,58	91
SB7800SM-9	7314150104697	1	7,72	91
SB7800TORX-E10	7314150240104	1	11,10	93
SB7800TORX-E11	7314150240111	1	11,10	93
SB7800TORX-E12	7314150240128	1	11,10	93
SB7800TORX-E14	7314150240135	1	11,10	93
SB7800TORX-E16	7314150240142	1	11,24	93
SB7800TORX-E18	7314150240159	1	11,24	93
SB7800TORX-E20	7314150240166	1	11,81	93
SB7800TORX-E24	7314150240173	1	12,92	93
SB7800TORX-E8	7314150240180	1	9,93	93
SB7805DM-10	7314150234851	1	17,84	92
SB7805DM-12	7314150234868	1	17,84	92
SB7805DM-13	7314150235032	1	17,84	92
SB7805DM-14	7314150235049	1	18,59	92
SB7805DM-15	7314150235056	1	19,51	92
SB7805DM-16	7314150235063	1	20,06	92
SB7805DM-17	7314150235070	1	20,06	92
SB7805DM-18	7314150235087	1	20,06	92
SB7805DM-19	7314150235094	1	20,06	92
SB7805DM-21	7314150235100	1	22,20	92
SB7805DM-22	7314150235117	1	22,39	92
SB7805DM-23	7314150327614	1	22,44	92
SB7805DM-24	7314150235124	1	23,06	93
SB7805DM-26	7314150240197	1	23,06	93
SB7805DM-27	7314150235131	1	25,49	93
SB7805DM-30	7314150235148	1	27,22	93
SB7805DM-32	7314150240203	1	27,83	93
SB7805DM-34	7314150521852	1	21,68	93
SB7805SM-10	7314150235155	1	18,14	91
SB7805SM-11	7314150524501	1	12,51	91
SB7805SM-12	7314150235162	1	18,14	91
SB7805SM-13	7314150235179	1	18,14	91
SB7805SM-14	7314150235193	1	18,88	91
SB7805SM-15	7314150235216	1	19,85	91
SB7805SM-16	7314150240210	1	20,34	91
SB7805SM-17	7314150235223	1	20,34	91
SB7805SM-18	7314150235230	1	20,34	91
SB7805SM-19	7314150235247	1	20,34	91
SB7805SM-20	7314150240227	1	21,07	91
SB7805SM-21	7314150235254	1	22,60	91
SB7805SM-22	7314150235261	1	22,78	91
SB7805SM-23	7314150240234	1	23,47	91
SB7805SM-24	7314150235278	1	23,47	91
SB7805SM-25	7314150240241	1	23,47	91
SB7805SM-26	7314150240258	1	23,47	91
SB7805SM-27	7314150235285	1	25,89	91
SB7805SM-28	7314150240265	1	24,17	91
SB7805SM-29	7314150240272	1	25,82	91
SB7805SM-30	7314150235292	1	27,66	91
SB7805SM-32	7314150235308	1	29,89	91
SB7805SM-34	7314150498284	1	32,67	91
SB7807H	7314150467297	1	47,20	177
SB7808H	7314150467303	1	47,20	177
SB7809H	7314150467341	1	52,27	177
SB7809M-10	7314153004185	1	15,25	96
SB7809M-12	7314153004208	1	15,58	96
SB7809M-14	7314153004215	1	15,97	96
SB7809M-17	7314153004222	1	16,48	96
SB7809M-19	7314153004239	1	16,73	96
SB7809M-4	7314150313952	1	14,17	96
SB7809M-5	7314153004109	1	14,17	96
SB7809M-5-180	7314153004116	1	22,64	96
SB7809M-6	7314153004123	1	14,17	96
SB7809M-7	7314153004130	1	14,17	96
SB7809M-7-100	7314153004147	1	18,24	96
SB7809M-8	7314153004154	1	15,25	96
SB7809M-8-120	7314153004161	1	20,82	96
SB7809M-9	7314153004178	1	15,25	96
SB7809TORX-T20	7314153004017	1	15,90	95
SB7809TORX-T25	7314153004024	1	15,90	95
SB7809TORX-T27	7314153004031	1	15,90	95
SB7809TORX-T30	7314153004048	1	15,90	95
SB7809TORX-T40	7314153004055	1	18,39	95
SB7809TORX-T45	7314153004062	1	18,39	95
SB7809TORX-T50	7314153004079	1	18,39	95
SB7809TORX-T55	7314153004086	1	22,74	95
SB7809TORX-T60	7314153004093	1	22,74	95
SB8150-1/2	7314150105014	1	65,66	97
SB8150RN-1/2	7314150105007	1	63,43	97
SB8154-11	7314150472178	1	24,01	93
SB8157-10	7314150474073	1	95,73	93
SB8157-15	7314150472468	1	56,16	93
SB8157-24	7314150474080	1	96,78	93
SB8157-36	7314150474097	1	133,82	93
SB8158-10	7314150488780	1	34,69	93
SB8158-15	7314150488797	1	44,22	93
SB8160-10	7314150472185	1	19,85	93
SB8160-3	7314150472192	1	16,42	93
SB8160-5	7314150472208	1	11,07	93

			€	
SB8166	7314150472154	1	35,75	94
SB8171	7314150479016	1	19,85	94
SB8172	7314150479023	1	23,33	94
SBA6700DM-10	7314150235575	1	5,80	79
SBA6700DM-11	7314150241750	1	5,80	79
SBA6700DM-12	7314150241767	1	5,80	79
SBA6700DM-13	7314150241774	1	5,80	79
SBA6700DM-14	7314150241781	1	5,80	79
SBA6700DM-5	7314150255054	1	5,80	79
SBA6700DM-5.5	7314150241798	1	5,80	79
SBA6700DM-6	7314150241804	1	5,80	79
SBA6700DM-7	7314150241811	1	5,80	79
SBA6700DM-8	7314150241828	1	5,80	79
SBA6700DM-9	7314150241835	1	5,80	79
SBA6700DZ-1/2	7314150241842	1	7,25	79
SBA6700DZ-1/4	7314150241859	1	7,16	79
SBA6700DZ-11/32	7314150241866	1	7,16	79
SBA6700DZ-3/16	7314150241873	1	7,16	79
SBA6700DZ-3/8	7314150241880	1	7,25	79
SBA6700DZ-5/16	7314150241897	1	7,16	79
SBA6700DZ-7/16	7314150241903	1	7,25	79
SBA6700DZ-7/32	7314150241910	1	7,16	79
SBA6700DZ-9/16	7314150241927	1	7,25	79
SBA6700DZ-9/32	7314150241934	1	7,16	79
SBA6709M-2.5	7314150254835	1	32,79	83
SBA6709M-3	7314150254828	1	32,79	83
SBA6709M-4	7314150254811	1	32,79	83
SBA6709M-5	7314150254804	1	32,62	83
SBA6709M-6	7314150254798	1	32,62	83
SBA6709Z-1/8	7314150254781	1	32,62	83
SBA6709Z-3/16	7314150254774	1	32,62	83
SBA6709Z-5/32	7314150254767	1	32,62	83
SBA6709Z-9/64	7314150254750	1	32,62	83
SBA6800DM-10	7314150250172	1	12,73	79
SBA6800DM-11	7314150250189	1	12,73	79
SBA6800DM-12	7314150250196	1	12,73	79
SBA6800DM-13	7314150250202	1	12,73	79
SBA6800DM-14	7314150250219	1	12,73	79
SBA6800DM-4	7314150250226	1	12,73	79
SBA6800DM-5	7314150250233	1	12,73	79
SBA6800DM-5.5	7314150250240	1	12,73	79
SBA6800DM-6	7314150250257	1	12,73	79
SBA6800DM-7	7314150250264	1	12,73	79
SBA6800DM-8	7314150250271	1	12,73	79
SBA6800DM-9	7314150250288	1	12,73	79
SBA6800DZ-1/2	7314150250295	1	15,23	80
SBA6800DZ-1/4	7314150250301	1	15,23	80
SBA6800DZ-11/32	7314150250318	1	15,23	80
SBA6800DZ-3/16	7314150250325	1	15,23	80
SBA6800DZ-3/8	7314150250332	1	15,23	80
SBA6800DZ-5/16	7314150250349	1	15,23	80
SBA6800DZ-7/16	7314150250356	1	15,23	80
SBA6800DZ-7/32	7314150250363	1	15,23	80
SBA6800DZ-9/16	7314150250370	1	15,23	80
SBA6800DZ-9/32	7314150250387	1	15,23	80
SBA7400DM-10	7314150241941	1	8,11	85
SBA7400DM-11	7314150241958	1	8,11	85
SBA7400DM-12	7314150241965	1	8,11	85
SBA7400DM-13	7314150241972	1	8,11	85
SBA7400DM-14	7314150241989	1	8,11	85
SBA7400DM-15	7314150241996	1	8,22	85
SBA7400DM-16	7314150242009	1	8,22	85
SBA7400DM-17	7314150242016	1	8,22	85
SBA7400DM-18	7314150242023	1	8,22	85
SBA7400DM-19	7314150242030	1	8,22	85
SBA7400DM-20	7314150242047	1	8,22	85
SBA7400DM-21	7314150242054	1	8,31	85
SBA7400DM-22	7314150242061	1	8,31	85
SBA7400DM-6	7314150242078	1	8,11	85
SBA7400DM-7	7314150242085	1	8,11	85
SBA7400DM-8	7314150242092	1	8,11	85
SBA7400DM-9	7314150242108	1	8,11	85
SBA7400DZ-1/2	7314150254705	1	8,93	86
SBA7400DZ-1/4	7314150242115	1	8,79	86
SBA7400DZ-11/16	7314150242122	1	9,04	86
SBA7400DZ-13/16	7314150242139	1	9,04	86
SBA7400DZ-17/32	7314150242146	1	8,93	86
SBA7400DZ-19/32	7314150242153	1	8,93	86
SBA7400DZ-3/4	7314150242160	1	9,04	86
SBA7400DZ-3/8	7314150242177	1	8,79	86
SBA7400DZ-5/16	7314150242184	1	8,79	86
SBA7400DZ-5/8	7314150242191	1	9,04	86
SBA7400DZ-7/16	7314150242207	1	8,93	86
SBA7400DZ-7/8	7314150242214	1	9,04	86
SBA7400DZ-9/16	7314150242221	1	8,93	86
SBA7402DM-10	7314150250394	1	15,60	86
SBA7402DM-11	7314150250400	1	15,60	86
SBA7402DM-12	7314150250417	1	15,60	86
SBA7402DM-13	7314150250424	1	15,60	86
SBA7402DM-14	7314150250431	1	16,27	86
SBA7402DM-15	7314150250448	1	16,27	86
SBA7402DM-16	7314150250455	1	16,27	86
SBA7402DM-17	7314150250462	1	17,33	86
SBA7402DM-18	7314150250479	1	17,33	86
SBA7402DM-19	7314150250486	1	17,33	86
SBA7402DM-7	7314150250493	1	15,58	86

			€	
SBA7402DM-8	7314150250509	1	15,58	86
SBA7402DM-9	7314150250516	1	15,60	86
SBA7402DZ-1/2	7314150250523	1	17,41	86
SBA7402DZ-1/4	7314150250530	1	17,41	86
SBA7402DZ-11/16	7314150250547	1	17,41	86
SBA7402DZ-13/16	7314150250554	1	17,41	86
SBA7402DZ-19/32	7314150250561	1	17,41	86
SBA7402DZ-3/4	7314150250578	1	17,41	86
SBA7402DZ-3/8	7314150250585	1	17,41	86
SBA7402DZ-5/16	7314150250592	1	17,41	86
SBA7402DZ-5/8	7314150250608	1	17,41	86
SBA7402DZ-7/16	7314150250615	1	17,41	86
SBA7402DZ-7/8	7314150250622	1	17,41	86
SBA7402DZ-9/16	7314150250639	1	17,41	86
SBC110-65	7314150456246	1	2,49	573
SBE-8135TB	7314150320424	1	9,15	199
SBE-8145TB	7314150320431	1	11,83	199
SBE-8150TB	7314150320448	1	13,59	199
SBE-8155TB	7314150320455	1	15,88	199
SBE-8610TB	7314150320493	1	14,45	199
SBE-8620TB	7314150320509	1	15,97	199
SBE-8810TB	7314150320530	1	13,02	199
SBE-8820TB	7314150320547	1	18,17	199
SBE-8915TB	7314150320585	1	11,50	200
SBE-8920TB	7314150320592	1	11,69	200
SBE-8925TB	7314150320608	1	12,39	200
SBE-8930TB	7314150320622	1	14,14	200
SBE-8940TB	7314150320639	1	15,89	200
SBK6701M-10	7314150445233	1	7,35	172
SBK6701M-11	7314150445240	1	7,35	172
SBK6701M-12	7314150445264	1	9,11	172
SBK6701M-13	7314150445271	1	9,11	172
SBK6701M-14	7314150445288	1	9,11	172
SBK6701M-6	7314150445196	1	7,35	172
SBK6701M-7	7314150445202	1	7,35	172
SBK6701M-8	7314150445219	1	7,35	172
SBK6701M-9	7314150445226	1	7,35	172
SBK7401M-10	7314150445325	1	8,41	173
SBK7401M-11	7314150445332	1	8,41	173
SBK7401M-12	7314150445349	1	8,41	173
SBK7401M-13	7314150445356	1	8,41	173
SBK7401M-14	7314150445363	1	8,41	173
SBK7401M-15	7314150445370	1	8,41	173
SBK7401M-16	7314150445387	1	8,41	173
SBK7401M-17	7314150445394	1	8,41	173
SBK7401M-18	7314150445400	1	9,88	173
SBK7401M-19	7314150445417	1	9,88	173
SBK7401M-20	7314150445424	1	10,17	173
SBK7401M-21	7314150445431	1	10,17	173
SBK7401M-22	7314150445448	1	10,62	173
SBK7401M-24	7314150445455	1	10,71	173
SBK7401M-7	7314150445295	1	8,41	173
SBK7401M-8	7314150445301	1	8,41	173
SBK7401M-9	7314150445318	1	8,41	173
SBK7764D	7314150447800	1	22,93	177
SBK7801M-10	7314150445486	1	10,05	175
SBK7801M-11	7314150445493	1	10,05	175
SBK7801M-12	7314150445509	1	10,05	175
SBK7801M-13	7314150445516	1	10,05	175
SBK7801M-14	7314150445523	1	10,40	175
SBK7801M-15	7314150445530	1	10,40	175
SBK7801M-16	7314150445547	1	10,40	175
SBK7801M-17	7314150445554	1	11,38	175
SBK7801M-18	7314150445561	1	11,38	175
SBK7801M-19	7314150445578	1	11,38	175
SBK7801M-20	7314150445585	1	11,38	175
SBK7801M-21	7314150445592	1	11,38	175
SBK7801M-22	7314150445608	1	12,20	175
SBK7801M-23	7314150445615	1	12,24	175
SBK7801M-24	7314150445622	1	12,24	175
SBK7801M-25	7314150445639	1	12,24	175
SBK7801M-26	7314150445646	1	12,24	175
SBK7801M-27	7314150445653	1	15,20	175
SBK7801M-28	7314150450763	1	14,55	175
SBK7801M-29	7314150450770	1	14,63	175
SBK7801M-30	7314150445660	1	16,53	175
SBK7801M-32	7314150445677	1	23,69	175
SBK7801M-34	7314150445684	1	25,75	175
SBK7801M-36	7314150445691	1	25,75	175
SBK7801M-8	7314150445462	1	7,98	175
SBK7801M-9	7314150445479	1	7,98	175
SBK7801Z-1	7314150448036	1	13,93	176
SBK7801Z-1.1/16	7314150448142	1	15,02	176
SBK7801Z-1.1/2	7314150448203	1	34,69	176
SBK7801Z-1.1/4	7314150448166	1	26,17	176
SBK7801Z-1.1/8	7314150448159	1	15,92	176
SBK7801Z-1.3/8	7314150448180	1	30,28	176
SBK7801Z-1.5/16	7314150448173	1	30,28	176
SBK7801Z-1.7/16	7314150448197	1	30,28	176
SBK7801Z-1/2	7314150448067	1	11,00	176
SBK7801Z-11/16	7314150448098	1	11,36	176
SBK7801Z-13/16	7314150448111	1	11,52	176
SBK7801Z-15/16	7314150448135	1	13,40	176
SBK7801Z-3/4	7314150448104	1	11,36	176



SBK7801Z-3/8



SBK7801Z-3/8	7314150448043	1	11,00	176
SBK7801Z-5/8	7314150448081	1	11,36	176
SBK7801Z-7/16	7314150448050	1	11,00	176
SBK7801Z-7/8	7314150448128	1	11,52	176
SBK7801Z-9/16	7314150448074	1	11,36	176
SBK7806M-10	7314150447831	1	13,15	176
SBK7806M-11	7314150447862	1	13,15	176
SBK7806M-12	7314150447879	1	13,15	176
SBK7806M-13	7314150447886	1	13,15	176
SBK7806M-14	7314150447893	1	13,15	176
SBK7806M-15	7314150447909	1	13,30	176
SBK7806M-16	7314150447916	1	13,30	176
SBK7806M-17	7314150447923	1	13,30	176
SBK7806M-18	7314150447930	1	13,34	176
SBK7806M-19	7314150447947	1	13,34	176
SBK7806M-21	7314150447954	1	13,34	176
SBK7806M-22	7314150447961	1	13,34	176
SBK7806M-23	7314150447978	1	13,93	176
SBK7806M-24	7314150447985	1	13,75	176
SBK7806M-27	7314150447992	1	15,93	176
SBK7806M-30	7314150448005	1	17,94	176
SBK7806M-32	7314150448012	1	20,85	176
SBK7806M-36	7314150448029	1	24,04	176
SBK7806Z-1	7314150448401	1	16,39	177
SBK7806Z-1.1/16	7314150448418	1	17,46	177
SBK7806Z-1.1/2	7314150448470	1	39,96	177
SBK7806Z-1.1/4	7314150448432	1	30,10	177
SBK7806Z-1.1/8	7314150448425	5	19,67	177
SBK7806Z-1.3/8	7314150448456	5	34,86	177
SBK7806Z-1.5/16	7314150448449	1	34,86	177
SBK7806Z-1.7/16	7314150448463	5	34,86	177
SBK7806Z-1/2	7314150448326	10	14,40	176
SBK7806Z-11/16	7314150448357	1	14,55	176
SBK7806Z-13/16	7314150448371	1	14,60	176
SBK7806Z-15/16	7314150448395	1	15,05	177
SBK7806Z-3/4	7314150448364	1	14,60	176
SBK7806Z-3/8	7314150448302	10	14,40	176
SBK7806Z-5/8	7314150448340	5	14,55	176
SBK7806Z-7/16	7314150448319	10	14,40	176
SBK7806Z-7/8	7314150448388	1	14,60	176
SBK7806Z-9/16	7314150448333	10	14,40	176
SBK8160D-1	7314150447770	1	14,85	177
SBK8160D-2	7314150447787	1	18,10	177
SBK8160D-3	7314150447794	1	28,26	177
SBK8901M-17	7314150448487	1	17,61	179
SBK8901M-18	7314150448494	1	17,61	179
SBK8901M-19	7314150448500	1	17,33	179
SBK8901M-21	7314150448517	1	17,33	179
SBK8901M-22	7314150448524	1	17,33	179
SBK8901M-23	7314150448531	1	17,61	179
SBK8901M-24	7314150448548	1	17,33	179
SBK8901M-27	7314150448555	1	17,33	179
SBK8901M-28	7314150448562	1	17,71	179
SBK8901M-29	7314150448579	1	17,98	179
SBK8901M-30	7314150448586	1	18,35	179
SBK8901M-32	7314150448593	1	19,00	179
SBK8901M-33	7314150448609	1	19,98	179
SBK8901M-34	7314150448616	1	20,17	179
SBK8901M-36	7314150448623	1	21,19	179
SBK8901M-38	7314150448630	1	21,97	179
SBK8901M-41	7314150448647	1	24,62	179
SBK8901M-46	7314150448654	1	28,42	179
SBK8901M-50	7314150448661	1	33,09	179
SBK8901M-55	7314150448678	1	39,73	179
SBK8901M-60	7314150448685	1	44,96	179
SBK8964D	7314150447817	1	11,76	177
SBS19-TH10	7314150190072	1	5,70	90
SBS19-TH11	7314150190089	1	5,70	90
SBS19-TH12	7314150190096	1	5,70	90
SBS19-TH13	7314150190102	1	5,70	90
SBS19-TH14	7314150190119	1	5,88	90
SBS19-TH15	7314150190126	1	5,88	90
SBS19-TH16	7314150190133	1	5,88	90
SBS19-TH17	7314150190140	1	6,72	90
SBS19-TH18	7314150190157	1	6,72	90
SBS19-TH19	7314150190164	1	6,72	90
SBS19-TH21	7314150190256	1	7,39	90
SBS19-TH22	7314150190188	1	7,39	90
SBS19-TH24	7314150190195	1	7,95	90
SBS19-TH75	7314150190201	1	9,70	90
SBS20-12	7314153009166	1	6,92	41
SBS20-15	7314153009197	1	7,83	41
SBS20-16	7314153009203	1	8,38	41
SBS20-20	7314153009241	1	11,54	41
SBS20-9	7314153009135	1	5,83	41
SBS61	7314153009661	1	24,24	84
SBS61S	7314150179886	1	23,40	84
SBS750	7314153012883	10	33,63	89
SBS81	7314153009937	5	41,04	97



SBSL25	7314153015853	5	46,23	63
SC127	7314150121984	10	12,83	579
SC127S	7314150121991	10	13,24	579
SC127V	7314150121847	5	23,79	502
SC140	7314150122004	10	13,49	579
SC140C	7314150122011	10	14,14	579
SC150NG	7314150122028	10	18,74	579
SC150NGV	7314150121854	5	36,71	502
SC2RM-13-17	7314150265350	10	37,14	102
SC2RM-15-17	7314150265367	10	37,74	102
SC2RM-19-22	7314150181384	10	38,93	102
SC2RM-27-30	7314150265343	1	70,08	102
SC335M-17	7314150344314	1	10,17	52
SC335M-19	7314150344321	1	14,78	52
SC335M-22	7314150344338	1	19,95	52
SC335M-24	7314150344345	1	21,76	52
SC335M-27	7314150344352	1	29,65	52
SC335M-30	7314150344369	1	37,05	52
SC335M-32	7314150344376	1	37,96	52
SC335M-36	7314150344383	1	43,13	52
SC335M-41	7314150344390	1	58,34	52
SC335M-46	7314150344406	1	73,63	52
SCB140	7314150297351	10	26,53	579
SCB140G	7314150297368	10	29,12	579
SCRAPER-SET2	7311518228613	1	108,01	548
SE-15-24	7311518029838	5	8,38	633
SE-15-30	7311518029821	5	8,90	633
SE-15-30-23	7311518029845	5	8,98	633
SE-15-32	7311518249168	5	9,82	633
SE-15-36	7311518141202	5	10,45	633
SE-15-36-23	7311518258276	5	10,40	633
SE-16-21	7311518029807	5	8,53	633
SE-16-21-23	7311518273934	5	7,37	633
SH-407	7314150389827	1	4,50	596
SH-427-700	7314150349074	10	5,97	596
SH-428-700	7314150349081	10	8,62	596
SH-485W	7314150358021	1	9,27	594
SH-485W-PLATES	7314150358038	1	7,37	594
SH-486-493-495	7314150349098	10	5,97	596
SH-486F493F495F	7314150349104	10	8,62	596
SH-486W	7314150358014	1	8,68	595
SH-488-2000	7314150346912	10	13,01	596
SH-488-34	7314150349036	10	18,84	596
SH-488-56	7314150349043	10	20,57	596
SH-488F-2000	7314150346950	10	16,05	596
SH-488F-34	7314150349050	1	19,90	596
SH-488F-56	7314150349067	1	21,23	596
SH-491-34	7314150374298	12	18,27	596
SH-491-56	7314150374304	12	29,06	596
SH-FCP-860	7311518324421	1	33,63	601
SH-FCS-810	7311518140540	1	27,06	601
SH-FCS-860	7311518140557	1	31,07	601
SH-FGS-1.8-810	7311518327828	1	20,22	601
SH-FGS-600	7311518140649	1	21,44	601
SH-FGS-700	7311518140656	12	23,40	601
SH-FGS-800	7311518140663	1	27,87	601
SH-HFGPS-400FG	7311518282301	1	19,33	601
SH-HGPS-360	7311518140618	12	14,49	601
SH-HGPS-380	7311518140625	1	15,54	601
SH-HGPS-400	7311518207618	1	17,15	601
SH-HUS-380	7311518140502	1	15,54	601
SH-HUS-500	7311518140519	1	20,39	601
SH-HUS-650	7311518140526	1	23,05	601
SH-MCS-800	7311518140595	1	27,87	601
SH-MES-900	7311518140601	12	26,82	601
SH-MES-900FG	7311518282318	12	40,15	601
SH-MES-F-900	7311518141554	12	20,89	601
SH-PAGS-900	7311518327866	1	20,57	601
SH-PAGS-900FG	7311518326944	1	47,59	601
SH-SUS-800	7311518140809	12	27,87	601
SHARP-INS	7314150197897	100	10,80	566
SHARP-X	7311518264895	10	23,25	636
SHARP-X-DISP	7311518264901	1	697,29	636
SL24	7314150128389	1	43,21	64
SL25	7314153013422	20	42,83	63
SL25AF	7314150180141	20	42,83	64
SL25L	7314150256570	10	60,17	64
SL34	7314150409181	6	83,32	70
SL65	7314150444137	6	86,52	64
SLX 17	7314153015785	1	269,86	76
SLX 17AF	7314150137558	1	269,86	76
SLX17-CASE	7314150321254	1	51,47	102
SP120	7314150312474	1	26,80	95
SP120XL	7314150313594	1	12,76	95
SPAR-CASE-A4	7314150263523	1	19,31	102
SPAR-CASE-A6	7314150263547	1	13,62	102
SPAR-CASE-A7	7314150263554	1	12,95	102
SQZ-MINI	7314150186280	24	9,72	582
SQZ-MINI-BLADE	7314150190348	1	5,22	582



SQZ150003	7314153013477	6	24,11	580
SQZ150003-HSBL	7314153015389	6	14,36	581
SR1000-E	7314153032918	20	14,98	544
SR1000-MM	7314153032857	20	14,98	543
SR150-E	7314153032864	12	2,07	544
SR150-MM	7314153032819	12	2,07	543
SR200-E	7314153032871	12	2,71	544
SR200-MM	7314153032826	12	2,71	543
SR300-E	7314153032888	12	3,64	544
SR300-MM	7314153032833	12	3,64	543
SR600-E	7314153032901	20	7,12	544
SR600-MM	7314153032840	20	7,12	543
SS001-100	7314150404384	1	90,91	526
SS001-150	7314150404377	1	102,46	526
SS001-200	7314150404391	1	149,23	526
SS001-250	7314150404407	1	184,27	526
SS001-300	7314150404414	1	243,99	526
SS001-375	7314150404421	1	378,88	526
SS001-450	7314150404438	1	447,81	526
SS001-600	7314150404445	1	750,62	526
SS002-10	7314150404483	1	20,34	526
SS002-11	7314150404490	1	22,72	526
SS002-12	7314150404506	1	23,92	526
SS002-13	7314150404513	1	25,11	526
SS002-14	7314150404520	1	26,31	526
SS002-15	7314150404537	1	27,51	526
SS002-16	7314150404551	1	28,71	526
SS002-17	7314150404568	1	29,90	526
SS002-19	7314150404575	1	31,10	526
SS002-21	7314150404582	1	38,75	526
SS002-22	7314150404599	1	41,85	526
SS002-24	7314150404605	1	47,12	526
SS002-27	7314150404612	1	68,18	526
SS002-32	7314150404629	1	93,17	526
SS002-6	7314150404469	1	13,02	526
SS002-6-2	7314150407903	1	155,50	526
SS002-7	7314150445790	1	19,06	526
SS002-8	7314150404476	1	16,38	526
SS002-9-2	7314150407910	1	229,66	526
SS003-10	7314150404643	1	18,19	526
SS003-11	7314150404650	1	21,29	526
SS003-12	7314150404667	1	23,33	526
SS003-14	7314150404681	1	25,11	526
SS003-16	7314150404704	1	27,51	526
SS003-18	7314150404711	1	29,42	526
SS003-20	7314150404728	1	31,10	526
SS003-22	7314150404735	1	32,53	526
SS003-24	7314150404742	1	34,09	526
SS003-25	7314150404759	1	40,66	526
SS003-26	7314150404766	1	43,07	526
SS003-28	7314150404773	1	44,25	526
SS003-30	7314150404780	1	52,63	526
SS003-8	7314150404636	1	16,74	526
SS011-0507	7314150404797	1	26,99	526
SS011-0607	7314150404803	1	27,60	526
SS011-0809	7314150404810	1	28,36	526
SS011-0810	7314150404827	1	28,64	526
SS011-0911	7314150404834	1	30,41	526
SS011-1012	7314150404858	1	30,89	526
SS011-11-3	7314150419142	1	776,99	527
SS011-1214	7314150404865	1	33,74	526
SS011-1417	7314150404872	1	39,00	526
SS011-1618	7314150404889	1	43,76	526
SS011-1719	7314150404896	1	47,86	526
SS011-1722	7314150404902	1	63,68	526
SS011-2224	7314150404919	1	72,95	526
SS011-2427	7314150404926	1	92,64	526
SS011-2430	7314150404940	1	131,77	526
SS011-3032	7314150404957	1	159,59	526
SS011-9-3	7314150419135	1	614,76	526
SS210-10	7314150405343	1	23,17	527
SS210-11	7314150405350	1	25,75	527
SS210-12	7314150405367	1	29,12	527
SS210-13	7314150405374	1	31,06	527
SS210-14	7314150405381	1	32,23	527
SS210-4	7314150405268	1	13,33	527
SS210-4.5	7314150405275	1	13,33	527
SS210-5	7314150405282	1	13,33	527
SS210-5.5	7314150405299	1	13,33	527
SS210-6	7314150405305	1	16,05	527
SS210-7	7314150405312	1	17,48	527
SS210-8	7314150405329	1	19,54	527
SS210-9	7314150405336	1	21,87	527
SS220-10	7314150404995	1	35,59	527
SS220-11	7314150405008	1	37,53	527
SS220-12	7314150405022	1	40,12	527
SS220-13	7314150405039	1	41,41	527
SS220-14	7314150405053	1	43,36	527
SS220-15	7314150405060	1	46,59	527



SS220-16	7314150405077	1	48,54	527
SS220-17	7314150405084	1	50,47	527
SS220-18	7314150405091	1	53,06	527
SS220-19	7314150405114	1	55,65	527
SS220-20	7314150405121	1	58,24	527
SS220-21	7314150405138	1	59,54	527
SS220-22	7314150405145	1	60,82	527
SS220-23	7314150405152	1	66,00	527
SS220-24	7314150405176	1	69,89	527
SS220-25	7314150405183	1	73,77	527
SS220-26	7314150405190	1	84,12	527
SS220-27	7314150405206	1	86,71	527
SS220-28	7314150405213	1	93,18	527
SS220-29	7314150405220	1	97,06	527
SS220-30	7314150405237	1	102,25	527
SS220-31	7314150405244	1	112,59	527
SS220-32	7314150405251	1	112,59	527
SS220-8	7314150404964	1	33,01	527
SS220-9	7314150404988	1	34,29	527
SS224-17	7314150405398	1	72,47	527
SS224-19	7314150405404	1	75,07	527
SS224-22	7314150405411	1	81,53	527
SS224-24	7314150405428	1	91,88	527
SS224-27	7314150405435	1	97,06	527
SS224-30	7314150405442	1	112,59	527
SS224-32	7314150405459	1	128,13	527
SS224-34	7314150405466	1	141,07	527
SS224-36	7314150405473	1	148,84	527
SS224-41	7314150405480	1	174,72	527
SS224-46	7314150405497	1	207,07	527
SS224-50	7314150405503	1	231,66	527
SS224-55	7314150405510	1	330,02	527
SS224-60	7314150405527	1	386,96	527
SS224-65	7314150405534	1	491,79	527
SS234-16-100	7314150405572	1	51,77	527
SS234-16-200	7314150405589	1	84,12	527
SS234-16-250	7314150405602	1	97,06	527
SS234-24-100	7314150405619	1	112,59	527
SS234-24-200	7314150405626	1	122,94	527
SS234-24-250	7314150405633	1	169,20	527
SS236-08-80	7314150405718	1	61,78	527
SS236-16-80	7314150405701	1	84,12	527
SS236-24-110	7314150405725	1	148,84	527
SS238-08-250	7314150405657	1	113,89	527
SS238-16-250	7314150405640	1	115,18	527
SS238-24-350	7314150405664	1	161,77	527
SS242-08-200	7314150405558	1	148,84	527
SS242-16-245	7314150405541	1	155,30	528
SS242-24-320	7314150405565	1	304,14	528
SS243-08	7314150405688	1	54,97	527
SS243-16	7314150405671	1	128,86	527
SS243-24	7314150405695	1	326,50	527
SS324-1.5	7314150405732	2	4,21	528
SS324-10	7314150405824	1	12,91	528
SS324-2	7314150405749	2	4,21	528
SS324-2.5	7314150405756	2	4,21	528
SS324-3	7314150405763	1	4,52	528
SS324-4	7314150405770	1	4,95	528
SS324-5	7314150405787	1	6,03	528
SS324-6	7314150405794	1	6,68	528
SS324-8	7314150405817	1	10,44	528
SS325-10	7314150405886	1	11,31	529
SS325-12	7314150405879	1	13,99	529
SS325-2.5	7314150405909	2	5,39	529
SS325-3	7314150405862	2	5,39	529
SS325-3.5	7314150405923	2	7,18	529
SS325-4	7314150405848	1	5,92	529
SS325-4.5	7314150405930	1	9,57	529
SS325-5	7314150405893	1	6,46	529
SS325-6	7314150405855	1	8,61	529
SS325-7	7314150405916	1	9,16	529
SS325-8	7314150405831	1	9,69	529
SS400-160	7314150405978	1	59,93	529
SS400-180	7314150405985	1	75,07	529
SS400-200	7314150405992	1	95,77	529
SS402-160	7314150406005	1	64,32	530
SS402-200	7314150406012	1	70,02	530
SS406-160	7314150406029	1	64,71	530
SS406-200	7314150406036	1	74,68	530
SS410-250	7314150406043	1	99,65	530
SS410-300	7314150406050	1	155,30	530
SS412-200	7314150406067	1	97,06	530
SS415-225	7314150406074	1	148,84	530
SS502-1000-FB	7314150406081	1	110,01	530
SS502-1500-FB	7314150406098	1	155,30	530
SS502-2000-FB	7314150406104	1	199,31	530
SS502-2500-FB	7314150406111	1	251,07	530
SS502-3000-FB	7314150406128	1	297,66	530
SS502-3600-FB	7314150406135	1	355,90	530



SS506-1100-FB



SS506-1100-FB	7314150406197	1	128,13	530
SS506-200-FB	7314150406142	1	37,53	530
SS506-300-FB	7314150406159	1	50,47	530
SS506-500-FB	7314150406166	1	54,36	530
SS506-700-FB	7314150406173	1	97,06	530
SS506-900-FB	7314150406180	1	112,59	530
SS603-15-500	7314150406203	1	80,24	530
SS603-19-500	7314150406210	1	111,30	530
SS603-20-500	7314150406227	1	114,42	530
SS603-23-500	7314150406234	1	134,66	530
SS603-23-800	7314150406258	1	207,07	530
SS603-25-600	7314150406241	1	195,57	530
SS603-30-1000	7314150406265	1	452,96	530
SS610-16-160	7314150406272	1	38,83	530
SS610-18-200	7314150406289	1	56,30	530
SS610-24-300	7314150406296	1	176,01	530
SS610-25-400	7314150406302	1	275,66	530
SS610-30-500	7314150406319	1	372,73	530
SUP-20-LAM	7311518258351	4	56,65	563
SUS-2.0-800	7311518123451	4	83,51	600
SW65	7314150442898	6	92,70	64
SW79	7314150442904	4	175,10	63
SW91	7314150442942	4	190,55	63
TAH08-10	7314150305087	1	6,47	477
TAH08-11	7314150305094	1	6,47	477
TAH08-12	7314150305100	1	6,47	477
TAH08-13	7314150305117	1	6,47	477
TAH08-5.5	7314150305032	1	6,47	477
TAH08-6	7314150305049	1	6,47	477
TAH08-7	7314150305056	1	6,47	477
TAH08-8	7314150305063	1	6,47	477
TAH08-9	7314150305070	1	6,47	477
TAH08-H3	7314150305124	1	8,50	477
TAH08-H4	7314150305131	1	8,50	477
TAH08-H5	7314150305148	1	8,50	477
TAH08-H6	7314150305155	1	8,50	477
TAH08-H8	7314150305162	1	8,50	477
TAH08-PH1	7314150305179	1	9,40	477
TAH08-PH2	7314150305186	1	9,40	477
TAH08-PH3	7314150305193	1	9,40	477
TAH08-T10	7314150305223	1	10,58	478
TAH08-T15	7314150305230	1	10,58	478
TAH08-T20	7314150305247	1	10,58	478
TAH08-T25	7314150305254	1	10,93	478
TAH08-T27	7314150305261	1	10,93	478
TAH08-T30	7314150305278	1	10,93	478
TAH08-T40	7314150305285	1	10,93	478
TAH08-T8	7314150305209	1	10,58	478
TAH08-T9	7314150305216	1	10,58	478
TAH1-100-06-2-4	7314150307531	1	19,95	485
TAH1-110-08-1-2	7314150437825	1	22,08	485
TAH1-143-12-1-2	7314150307548	1	25,53	485
TAH1-160-08-1-2	7314150437818	1	19,80	485
TAH1-170-08-1-2	7314150437801	1	20,66	485
TAH1-210-06-2-2	7314150307555	1	23,01	485
TAH1-210-08-1-2	7314150437795	1	24,41	485
TAH1-230-06-2-2	7314150307562	1	12,57	485
TAH1-230-08-1-2	7314150437788	1	25,84	485
TAH111M-10	7314150308538	1	14,33	475
TAH111M-11	7314150308545	1	14,56	475
TAH111M-12	7314150308552	1	14,97	475
TAH111M-13	7314150308569	1	15,00	475
TAH111M-14	7314150308576	1	15,05	475
TAH111M-15	7314150308583	1	15,56	475
TAH111M-16	7314150308590	1	15,85	475
TAH111M-17	7314150308606	1	16,97	475
TAH111M-18	7314150308613	1	18,80	475
TAH111M-19	7314150308620	1	19,61	475
TAH111M-20	7314150308637	1	20,17	475
TAH111M-21	7314150308644	1	21,82	475
TAH111M-22	7314150308651	1	21,99	475
TAH111M-23	7314150308668	1	23,29	475
TAH111M-24	7314150308675	1	24,37	475
TAH111M-25	7314150399611	1	27,37	475
TAH111M-27	7314150308682	1	34,47	475
TAH111M-30	7314150308699	1	42,00	475
TAH111M-32	7314150308705	1	45,29	475
TAH111M-34	7314150308712	1	52,42	475
TAH111M-36	7314150308729	1	74,07	475
TAH111M-41	7314150308736	1	94,06	475
TAH111M-46	7314150308743	1	123,99	475
TAH111M-50	7314150308750	1	140,46	475
TAH111M-55	7314150411573	1	228,79	475
TAH111M-6	7314150308491	1	14,18	475
TAH111M-7	7314150308507	1	14,21	475
TAH111M-8	7314150308514	1	14,24	475
TAH111M-9	7314150308521	1	14,29	475
TAH111Z-1	7314150343362	1	33,48	475
TAH111Z-1.1/16	7314150343379	1	34,82	475



TAH111Z-1.1/2	7314150431830	1	72,51	475
TAH111Z-1.1/4	7314150343386	1	40,63	475
TAH111Z-1.1/8	7314150343393	1	38,47	475
TAH111Z-1.11/16	7314150431854	1	103,73	475
TAH111Z-1.13/16	7314150431878	1	123,05	475
TAH111Z-1.3/4	7314150431861	1	120,49	475
TAH111Z-1.3/8	7314150431816	1	72,52	475
TAH111Z-1.5/16	7314150343409	1	51,56	475
TAH111Z-1.5/8	7314150431847	1	99,65	475
TAH111Z-1.7/16	7314150431823	1	72,52	475
TAH111Z-1.7/8	7314150431885	1	152,66	475
TAH111Z-1/2	7314150343461	1	20,28	475
TAH111Z-1/4	7314150343508	1	16,18	475
TAH111Z-11/16	7314150343522	1	21,67	475
TAH111Z-13/16	7314150343539	1	28,88	475
TAH111Z-15/16	7314150343546	1	30,95	475
TAH111Z-2	7314150431892	1	153,22	475
TAH111Z-2.1/4	7314150431915	1	384,85	475
TAH111Z-2.3/4	7314150431946	1	520,88	475
TAH111Z-2.3/8	7314150413959	1	384,85	475
TAH111Z-2.5/8	7314150431939	1	506,92	475
TAH111Z-2.7/8	7314150431953	1	683,85	475
TAH111Z-3	7314150431960	1	707,62	475
TAH111Z-3/4	7314150343553	1	23,20	475
TAH111Z-3/8	7314150343560	1	19,16	475
TAH111Z-5/16	7314150343591	1	16,41	475
TAH111Z-5/8	7314150343607	1	21,96	475
TAH111Z-7/16	7314150343614	1	19,77	475
TAH111Z-7/8	7314150343621	1	30,41	475
TAH111Z-9/16	7314150343638	1	20,87	475
TAH1150-1/2H/P	7314150307760	1	131,37	488
TAH1177-SCRIBE	7314150307777	1	24,29	488
TAH140	7314150344475	1	72,04	477
TAH141	7314150339433	1	78,53	477
TAH1410	7314150344543	1	88,03	477
TAH142	7314150339440	1	102,87	477
TAH1420	7314150344550	1	97,38	477
TAH143	7314150344482	1	146,74	477
TAH1544	7314150307746	1	20,55	489
TAH16-H10	7314150306176	1	17,73	479
TAH16-H12	7314150306183	1	18,15	479
TAH16-H14	7314150306190	1	19,90	479
TAH16-H17	7314150306206	1	19,08	479
TAH16-H19	7314150306213	1	19,61	479
TAH16-H4	7314150306121	1	16,37	479
TAH16-H5	7314150306138	1	16,37	479
TAH16-H6	7314150306145	1	16,37	479
TAH16-H7	7314150306152	1	16,37	479
TAH16-H8	7314150306169	1	17,73	479
TAH16-T30	7314150306220	1	18,56	479
TAH16-T40	7314150306237	1	21,67	479
TAH16-T45	7314150306244	1	21,67	479
TAH16-T50	7314150306251	1	21,67	479
TAH16-T55	7314150306268	1	27,13	479
TAH16-T60	7314150306275	1	27,13	479
TAH16B-1	7314150306077	1	13,91	478
TAH16B-1.1/16	7314150306084	1	16,75	478
TAH16B-1.1/4	7314150306107	1	16,76	478
TAH16B-1.1/8	7314150306114	1	16,75	478
TAH16B-1/2	7314150305995	1	9,32	478
TAH16B-10	7314150305629	1	8,21	478
TAH16B-11	7314150305636	1	8,21	478
TAH16B-11/16	7314150306022	1	10,79	478
TAH16B-12	7314150305643	1	8,70	478
TAH16B-13	7314150305650	1	9,08	478
TAH16B-13/16	7314150306046	1	11,91	478
TAH16B-14	7314150305667	1	9,53	478
TAH16B-15	7314150305674	1	9,90	478
TAH16B-15/16	7314150306060	1	13,91	478
TAH16B-16	7314150305698	1	10,09	478
TAH16B-17	7314150305704	1	10,48	478
TAH16B-18	7314150305711	1	10,48	478
TAH16B-19	7314150305728	1	10,91	478
TAH16B-21	7314150305735	1	11,50	478
TAH16B-22	7314150305742	1	11,91	478
TAH16B-24	7314150305759	1	13,43	478
TAH16B-25	7314150305766	1	13,63	478
TAH16B-27	7314150305773	1	14,32	478
TAH16B-3/4	7314150306039	1	11,30	478
TAH16B-30	7314150305780	1	15,93	478
TAH16B-32	7314150305797	1	16,25	478
TAH16B-5/8	7314150306015	1	10,48	478
TAH16B-7/8	7314150306053	1	12,32	478
TAH16B-8	7314150305612	1	8,89	478
TAH16B-9/16	7314150306008	1	9,93	478
TAH16BM/22	7314150422357	1	499,12	479
TAH16BZ/17	7314150422340	1	429,80	479
TAH16H-1/2	7314150306329	1	17,46	479
TAH16H-1/4	7314150306282	1	16,06	479



TAH16H-3/8	7314150306305	1	16,06	479
TAH16H-5/16	7314150306299	1	16,06	479
TAH16H-5/8	7314150306343	1	18,36	479
TAH16H-7/16	7314150306312	1	16,53	479
TAH16H-9/16	7314150306336	1	17,89	479
TAH1949M-10-11	7314150308866	1	29,80	476
TAH1949M-12-14	7314150308873	1	33,39	476
TAH1949M-14-17	7314150308880	1	33,39	476
TAH1949M-19-22	7314150308897	1	45,66	476
TAH1949M-24-27	7314150308903	1	66,03	476
TAH1949M-8-9	7314150308859	1	29,80	476
TAH1995M-10	7314150432219	1	25,07	482
TAH1995M-12	7314150432226	1	26,33	482
TAH1995M-8	7314150432202	1	24,28	482
TAH1995Z-1/2	7314150415007	1	27,97	482
TAH1RM-10	7314150414338	1	30,18	475
TAH1RM-11	7314150424306	1	31,84	475
TAH1RM-12	7314150424313	1	32,72	475
TAH1RM-13	7314150414345	1	31,87	475
TAH1RM-14	7314150424320	1	36,17	475
TAH1RM-15	7314150424337	1	37,17	475
TAH1RM-16	7314150414352	1	38,05	475
TAH1RM-17	7314150352210	1	38,05	475
TAH1RM-18	7314150414369	1	39,28	475
TAH1RM-19	7314150352227	1	41,04	475
TAH1RM-21	7314150424344	1	50,80	475
TAH1RM-22	7314150424351	1	49,16	475
TAH1RM-24	7314150352234	1	53,36	475
TAH1RM-27	7314150424368	1	80,87	475
TAH1RM-30	7314150352241	1	95,53	475
TAH1RM-32	7314150424375	1	106,00	475
TAH1RM-6	7314150424269	1	28,94	475
TAH1RM-7	7314150424276	1	28,94	475
TAH1RM-8	7314150424283	1	29,07	475
TAH1RM-9	7314150424290	1	30,08	475
TAH2047-0.8-4	7314150308088	1	27,97	482
TAH2047PR-1-2	7314150308095	1	31,48	482
TAH2101G-125	7314150344581	1	57,36	482
TAH2101G-125C	7314150344598	1	57,36	482
TAH2101G-140	7314150307869	1	52,70	482
TAH2101G-140C	7314150344611	1	60,30	482
TAH2101G-160	7314150307876	1	61,06	482
TAH2101G-160C	7314150344635	1	61,06	482
TAH2101G-180	7314150345106	1	62,69	482
TAH2101G-180C	7314150344666	1	62,69	482
TAH21HDG-200	7314150345649	1	64,02	483
TAH21HDG-200C	7314150345656	1	64,02	483
TAH2223G-150	7314150411597	1	56,58	483
TAH225-PLUS	7314150319978	1	53,76	485
TAH2339-250	7314150536320	1	39,66	484
TAH2427G-200	7314150307883	1	44,77	483
TAH2430G-160	7314150413942	1	43,10	483
TAH2430G-200	7314150307906	1	43,61	483
TAH2484-30	7314150307968	1	15,42	487
TAH2487	7314150320028	1	21,45	489
TAH24B-27	7314150309306	1	25,19	479
TAH24B-30	7314150309313	1	28,27	479
TAH24B-32	7314150309320	1	29,44	479
TAH24B-36	7314150309337	1	34,03	479
TAH24B-38	7314150309344	1	36,24	479
TAH24B-41	7314150309351	1	39,93	479
TAH24B-46	7314150309368	1	47,12	479
TAH24B-50	7314150309375	1	53,24	479
TAH2509	7314150307753	1	94,11	490
TAH2535F2	7314150307784	1	51,18	490
TAH2628G-160	7314150307913	1	56,75	483
TAH2628G-180	7314150307920	1	58,49	483
TAH2628G-200	7314150432363	1	74,65	483
TAH2633/S4	7314150415014	1	122,64	490
TAH2800-150	7314150519330	1	44,81	483
TAH2800-180	7314150424559	1	75,54	483
TAH2820EF2	7314150307708	1	27,56	485
TAH2855	7314150307937	1	205,05	484
TAH2900-180	7314150424566	1	76,17	483
TAH2951-250	7314150432400	1	62,05	484
TAH2953-140	7314150415731	1	57,40	484
TAH2953-300	7314150415748	1	73,02	484
TAH2958-200	7314150320219	1	45,94	484
TAH2958-250	7314150307944	1	49,64	484
TAH2970G-200	7314150343331	1	59,47	483
TAH29M-10	7314150414413	1	79,61	476
TAH29M-11	7314150414420	1	80,24	476
TAH29M-12	7314150424382	1	80,24	476
TAH29M-13	7314150414437	1	80,24	476
TAH29M-14	7314150424399	1	80,24	476
TAH29M-15	7314150424405	1	80,24	476
TAH29M-16	7314150424412	1	80,24	476
TAH29M-17	7314150414444	1	80,85	476
TAH29M-18	7314150424429	1	80,85	476



TAH29M-19	7314150424436	1	80,85	476
TAH29M-20	7314150424443	1	80,85	476
TAH29M-21	7314150414451	1	84,40	476
TAH29M-22	7314150424450	1	84,40	476
TAH29M-23	7314150424467	1	85,03	476
TAH29M-24	7314150424474	1	89,61	476
TAH29M-25	7314150424481	1	90,27	476
TAH29M-26	7314150424498	1	95,17	476
TAH29M-27	7314150424504	1	94,09	476
TAH29M-28	7314150424511	1	97,63	476
TAH29M-29	7314150424528	1	102,17	476
TAH29M-30	7314150424535	1	104,86	476
TAH29M-32	7314150424542	1	109,89	476
TAH29M-6	7314150414376	1	77,12	476
TAH29M-7	7314150414383	1	78,37	476
TAH29M-8	7314150414390	1	79,61	476
TAH29M-9	7314150414406	1	79,61	476
TAH2M-10-11	7314150427772	1	53,07	476
TAH2M-12-13	7314150427789	1	53,67	476
TAH2M-14-15	7314150427796	1	55,05	476
TAH2M-16-17	7314150427802	1	56,37	476
TAH2M-18-19	7314150427819	1	58,22	476
TAH2M-6-7	7314150427758	1	50,14	476
TAH2M-8-9	7314150427765	1	52,17	476
TAH317	7314150319985	1	39,28	485
TAH320	7314150319992	1	28,80	484
TAH325	7314150320004	1	73,07	484
TAH3625PU-50	7314150307579	1	62,53	486
TAH3625W-35	7314150307609	1	52,89	486
TAH3640-250-C	7314150307975	1	33,89	487
TAH3681-11	7314150415038	1	71,49	488
TAH3681-16	7314150415045	1	79,03	488
TAH3681-20	7314150415052	1	97,15	488
TAH3683	7314150352258	1	43,43	487
TAH3734BM-10	7314150308057	1	23,37	487
TAH3734BM-2	7314150343348	1	29,95	487
TAH3734BM-3	7314150307982	1	29,95	487
TAH3734BM-4	7314150308019	1	30,41	487
TAH3734BM-5	7314150308026	1	30,41	487
TAH3734BM-6	7314150308033	1	31,26	487
TAH3734BM-8	7314150308040	1	31,48	487
TAH3739-300	7314150373925	1	34,15	487
TAH3755BM-4	7314150308064	1	16,54	487
TAH380-10	7314150307845	1	71,14	477
TAH380-14	7314150320172	1	94,57	477
TAH380-18	7314150307852	1	135,06	477
TAH380-24	7314150343317	1	200,36	477
TAH396-JT	7314150373932	1	58,37	484
TAH4205H-80-160	7314150411610	1	44,82	489
TAH466-250	7314150307791	1	44,42	488
TAH479-16	7314150307586	1	62,93	486
TAH479-32	7314150307593	1	68,89	486
TAH481-300	7314150307616	1	49,86	486
TAH484-1000	7314150373918	1	62,24	486
TAH484-1500	7314150307623	1	60,26	486
TAH484-2000	7314150319916	1	63,20	486
TAH485	7314150459902	1	60,67	487
TAH486F-700	7314150370658	1	31,89	486
TAH487-5200	7314150307630	1	594,59	487
TAH489-1100	7314150307647	1	204,94	486
TAH489-1800	7314150343294	1	219,51	486
TAH489-2700	7314150319923	1	228,59	486
TAH489-3600	7314150307654	1	252,12	486
TAH489-4500	7314150427567	1	352,14	486
TAH489-5400	7314150319930	1	297,56	486
TAH490-1100	7314150427475	1	162,21	486
TAH490-700	7314150427529	1	131,77	486
TAH490-900	7314150427536	1	137,92	486
TAH52	7314150339730	1	24,68	486
TAH6950	7314150309054	1	51,20	478
TAH6956-1	7314150309061	1	15,15	478
TAH6958B-1	7314150309078	1	44,30	477
TAH6960	7314150305315	1	11,90	477
TAH6961	7314150305322	1	12,91	477
TAH6962	7314150305339	1	16,50	477
TAH6962L	7314150305346	1	37,64	477
TAH6966	7314150305353	1	29,80	477
TAH6M-10-11	7314150370665	1	16,74	476
TAH6M-12-13	7314150370672	1	17,16	476
TAH6M-14-15	7314150400393	1	17,41	476
TAH6M-16-17	7314150400409	1	17,76	476
TAH6M-17-19	7314150370689	1	20,45	476
TAH6M-18-19	7314150400416	1	20,55	476
TAH6M-20-22	7314150400423	1	25,08	476
TAH6M-24-27	7314150400430	1	43,91	476
TAH6M-30-32	7314150400447	1	50,90	476
TAH6M-6-7	7314150427741	1	13,75	476
TAH6M-8-9	7314150400386	1	14,35	476
TAH700-1.5-50	7314150432301	1	54,44	481



TAH700-1.8-50



TAH700-1.8-50	7314150432318	1	54,44	481
TAH700-2.5-50	7314150432325	1	54,92	481
TAH700-3-100	7314150432332	1	54,92	481
TAH701-0-50	7314150432349	1	54,49	481
TAH701-00-50	7314150432356	1	54,49	481
TAH703-10-50	7314150432288	1	54,60	482
TAH703-15-75	7314150432295	1	54,81	482
TAH703-6-50	7314150432240	1	54,63	482
TAH703-7-50	7314150432257	1	54,63	482
TAH703-8-50	7314150432264	1	54,63	482
TAH703-9-50	7314150432271	1	54,68	482
TAH73R-100	7314150503810	1	442,36	489
TAH73R-200	7314150503834	1	457,11	489
TAH73R-300	7314150503858	1	473,96	489
TAH7444SG-M-36	7314150308934	1	66,62	476
TAH7444SG-M-41	7314150308941	1	85,04	476
TAH7444SG-M-46	7314150308958	1	93,23	476
TAH7444SG-M-50	7314150308965	1	104,81	476
TAH7444SG-M-55	7314150308972	1	119,85	476
TAH7445-100A-1	7314150327546	1	326,82	489
TAH7452-2	7314150302543	1	120,65	489
TAH7455-300-1	7314150309412	1	397,31	489
TAH74W9-100	7314150519354	1	260,51	489
TAH782-U	7314150339747	1	23,61	486
TAH7852-1	7314150302550	1	96,31	489
TAH8069	7314150383603	1	52,65	475
TAH8069C	7314150383610	1	54,99	475
TAH8070	7314150347025	1	50,69	475
TAH8070C	7314150383627	1	39,37	475
TAH8071	7314150347032	1	54,69	475
TAH8071C	7314150383634	1	40,77	475
TAH8072	7314150307487	1	50,79	475
TAH8072C	7314150383641	1	44,70	475
TAH8073	7314150319831	1	73,78	475
TAH8073C	7314150383658	1	54,33	475
TAH8074	7314150319848	1	120,60	475
TAH8074C	7314150383665	1	90,80	475
TAH8075	7314150307500	1	189,48	475
TAH8075C	7314150383672	1	129,88	475
TAH8150-1/2	7314150309283	1	81,82	479
TAH8158B-1	7314150309290	1	106,88	478
TAH8160	7314150306367	1	81,85	478
TAH8162	7314150306374	1	100,54	478
TAH8166	7314150306381	1	41,56	478
TAH8224	7314150307951	1	73,52	484
TAH84-PODGER	7314150312221	1	52,46	475
TAH8950N/A	7314150309382	1	203,81	480
TAH8953	7314150309399	1	56,08	479
TAH8961	7314150309405	1	49,21	479
TAH9045-B-250	7314150411634	1	37,07	488
TAH9048-250	7314150411627	1	38,23	488
TAH9070	7314150307517	1	44,59	475
TAH9072	7314150307524	1	63,04	475
TAHBE-8020L	7314150308101	1	19,26	480
TAHBE-8030	7314150308118	1	19,79	480
TAHBE-8040	7314150308125	1	20,68	480
TAHBE-8040S	7314150308132	1	13,16	481
TAHBE-8050S	7314150308149	1	15,70	481
TAHBE-8155	7314150308156	1	29,96	480
TAHBE-8220S	7314150308163	1	10,85	481
TAHBE-8241	7314150308217	1	24,19	480
TAHBE-8252	7314150308224	1	28,34	480
TAHBE-8255S	7314150320226	1	20,08	481
TAHBE-8257	7314150308231	1	35,14	480
TAHBE-8258	7314150308248	1	37,50	480
TAHBE-8260	7314150308255	1	40,78	480
TAHBE-8350	7314150308262	1	21,71	480
TAHBE-8602	7314150308279	1	24,02	480
TAHBE-8610	7314150308286	1	23,71	480
TAHBE-8610S	7314150308293	1	13,96	481
TAHBE-8611	7314150308300	1	23,84	480
TAHBE-8620	7314150308316	1	27,56	480
TAHBE-8620L	7314150308323	1	31,04	480
TAHBE-8620S	7314150308330	1	18,02	481
TAHBE-8623	7314150308347	1	35,00	480
TAHBE-8624	7314150308354	1	39,99	480
TAHBE-8630	7314150308361	1	42,62	480
TAHBE-8630S	7314150320233	1	23,09	481
TAHBE-8640S	7314150320240	1	34,18	481
TAHBE-8810	7314150308378	1	25,29	481
TAHBE-8820	7314150308385	1	29,00	481
TAHBE-8820SL	7314150347827	1	21,69	481
TAHBE-8830	7314150308392	1	42,62	481
TAHBE-8880	7314150432196	1	53,59	480
TAHBE-8910	7314150343713	1	27,11	481
TAHBE-8910S	7314150343799	1	20,01	481
TAHBE-8915	7314150343744	1	28,01	481
TAHBE-8915S	7314150343805	1	25,34	481
TAHBE-8920	7314150343751	1	29,34	481



TAHBE-8920S	7314150343812	1	30,02	481
TAHBE-8925	7314150343768	1	30,68	481
TAHBE-8925S	7314150343829	1	32,02	481
TAHBE-8930	7314150343775	1	32,02	481
TAHBE-8930S	7314150343836	1	33,35	481
TAHBE-9776	7314150432233	1	48,43	482
TAHBE-9777B	7314150307685	1	39,76	482
TAHBE-9787	7314150307692	1	42,57	482
TAHBE64520	7314150307821	1	96,33	490
TAHBFRL11	7314150307739	1	77,61	490
TAHBOD5400	7314150339457	1	51,41	490
TAHBOD5450	7314150339464	1	70,94	490
TAHCRW01	7314150432370	1	151,03	483
TAHCS300	7314150411603	1	37,07	488
TAHLTS-30	7314150432387	1	81,60	488
TAHMK5	7314150411580	1	44,40	476
TAHPINRELEASER	7314150337638	1	47,98	480
TAHSC2RM-13-17	7314150339792	1	54,69	476
TAHSC2RM-15-17	7314150339785	1	66,69	476
TAHSC2RM-19-22	7314150339761	1	73,37	476
TAHSC2RM-27-30	7314150339778	1	120,05	476
TAHSCB140G	7314150308071	1	41,68	485
TAHSR300-MM	7314150415021	1	51,17	488
TAHWBB600	7314150440429	1	39,14	487
TAHWBB700	7314150440436	1	41,68	487
TAM12135	7314150215331	1	404,05	115
TAM12200	7314150215348	1	404,05	115
TAM12340	7314150215355	1	494,63	115
TAM1430	7314150215317	1	362,33	115
TAM38135	7314150215324	1	362,33	115
TAS14H007	7314150423187	1	707,85	111
TAS14H09	7314150423200	1	726,81	111
TAS14S007	7314150423194	1	707,85	111
TAS14S09	7314150423217	1	726,81	111
TASM14H007	7314150539444	1	1.091,80	111
TASM14H09	7314150539437	1	1.122,70	111
TASMB14H007	7314150489664	1	1.606,98	111
TASMB14H09	7314150489671	1	1.644,36	111
TAW12340	7314150274963	1	774,42	105
TAW1412M	7314150423156	1	916,15	105
TAW1430M	7314150422289	1	916,15	105
TAW14340	7314150340842	1	1.039,93	105
TAW24800	7314150368297	1	1.233,30	105
TAW34800	7314150285471	1	1.375,26	105
TAW38135	7314150274956	1	707,66	105
TAW38135M	7314150502295	1	909,38	105
TAW912M	7314150423163	1	809,72	105
TAW9135	7314150340859	1	939,70	105
TAW9135M	7314150502288	1	884,46	105
TAW930M	7314150422319	1	830,65	105
TAWM12340	7314150274925	1	1.201,68	104
TAWM1412M	7314150423149	1	1.052,21	104
TAWM1430M	7314150422655	1	1.064,97	104
TAWM14340	7314150340835	1	1.265,46	104
TAWM24800	7314150368280	1	1.866,87	104
TAWM34800	7314150274932	1	1.729,07	104
TAWM38135	7314150274918	1	1.222,08	104
TAWM38135M	7314150502264	1	1.264,41	104
TAWM912M	7314150423132	1	1.027,38	104
TAWM9135	7314150340828	1	1.177,76	104
TAWM9135M	7314150502271	1	1.239,50	104
TAWM930M	7314150422241	1	1.084,84	104
TAWMB14340	7314150489626	1	1.930,88	104
TAWMB24650	7314150490103	1	2.229,85	104
TAWMB24800	7314150489633	1	2.478,25	104
TAWMB9135M	7314150490110	1	1.818,76	104
TAWMB930M	7314150489640	1	1.706,65	104
TEA003	7314150422180	1	1.568,46	114
TEA010	7314150422197	1	1.568,46	114
TEA030	7314150465781	1	1.493,77	114
TEA030A	7314150522750	1	1.493,50	114
TEA065	7314150472246	1	1.476,96	115
TEA1100	7314150423170	1	1.960,56	115
TEA2100	7314150465972	1	2.444,17	115
TEA350	7314150422210	1	1.459,73	115
TJS003	7314150522477	1	289,43	114
TJS010	7314150522484	1	295,61	114
TJS030	7314150522491	1	313,12	114
TL 00-SA	7314150109579	1	38,26	656
TL 00-SA-ET	7311518279219	1	45,11	659
TL 00-SA-SL	7314150115228	5	19,11	660
TL 000-SA	7314150522934	1	30,99	656
TL 00ACF	7314150522958	1	7,90	663
TL 00B-SA	7314150109555	1	42,47	656
TL 00CFR-SA	7314150115402	1	50,18	658
TL 00D-SA	7314150109562	1	42,47	656
TL 009-SA	7314150109586	1	36,70	656
TL 1-SA	7314150109647	1	36,70	656
TL 1-SA-SL	7314150115235	5	18,36	660



TL 124-SA	7314150110018	1	31,57	662
TL 15A	7314150522972	1	53,54	656
TL 15AGW	7314150522996	1	53,46	656
TL 15AGWHM-SA	7314150523016	1	90,48	656
TL 2-SA-SL	7314150115242	5	18,76	660
TL 242ACF	7314150523030	1	7,90	663
TL 242CFR-SA	7314150523054	1	26,85	658
TL 249 ACF	7314150115174	1	15,16	663
TL 249CFR-SA	7314150115143	1	50,18	658
TL 259 ACF	7314150115167	1	15,16	663
TL 259 CFR-SA	7314150115150	1	50,18	658
TL 259ACP	7314150465590	1	106,79	663
TL 259ASV	7314150465569	1	13,03	663
TL 259CPR-SA	7314150523078	1	28,11	658
TL 259SVR-SA	7314150523092	1	42,18	658
TL 2A ACF	7314150115457	1	15,16	663
TL 2A-SA	7314150110100	1	37,50	656
TL 2A-SA-ET	7314150523115	1	34,26	659
TL 2A-SA-SL	7314150115259	5	18,76	660
TL 2ACFR-SA	7314150115419	1	50,18	658
TL 3-SA	7314150110162	1	36,70	657
TL 3-SA-ET	7311518279356	1	45,11	659
TL 3-SA-SL	7314150115266	5	18,36	660
TL 34A-SA	7314150524068	1	40,53	657
TL 3C-SA	7314150110148	1	36,70	657
TL 3C-SA-ET	7314150523139	1	34,63	659
TL 3C-SA-SL	7314150115273	5	18,36	660
TL 4-SA-SL	7314150115280	5	20,40	660
TL 475-SA	7314150110032	1	37,41	662
TL 5-SA	7314150110247	1	44,49	657
TL 5-SA-ET	7314150523153	1	38,14	659
TL 5-SA-SL	7314150115297	5	22,26	660
TL 51S-SA	7314150110209	1	41,21	657
TL 578-SA	7314150110438	1	32,84	662
TL 582-SA	7314150110452	1	32,84	662
TL 5A-SA-SL	7314150115303	5	22,26	660
TL 5ACF	7314150115464	1	15,16	663
TL 5ACP	7314150465606	1	106,79	664
TL 5ASV	7314150465576	1	106,79	663
TL 5B-SA	7314150110223	1	47,77	657
TL 5CF-SA	7314150523177	1	25,72	658
TL 5CFR-SA	7314150115426	1	50,18	658
TL 5CPR-SA	7314150523191	1	28,11	658
TL 5SVR-SA	7314150523214	1	28,11	658
TL 6-SA	7314150523238	1	40,53	657
TL 648-SA	7314150110049	1	33,53	662
TL 649-SA	7314150110063	1	33,44	662
TL 65A-SA	7314150110278	1	42,85	657
TL 7-SA	7314150110292	1	47,77	657
TL 7-SA-ET	7314150523252	1	40,03	659
TL 7-SA-SL	7314150115310	5	23,87	661
TL 7A-SA	7314150110285	1	47,77	657
TL 7A-SA-ET	7314150523283	1	40,03	659
TL 7A-SA-SL	7314150115327	5	24,07	661
TL 7ACF	7314150115471	1	15,16	664
TL 7ACP	7314150465613	1	106,79	664
TL 7ASV	7314150465583	1	106,79	664
TL 7CFR-SA	7314150115433	1	50,18	659
TL 7CPR-SA	7314150523306	1	28,11	659
TL 7SVR-SA	7314150523320	1	28,11	659
TL AA-SA-ET	7314150523344	1	27,99	659
TL AA-SA-SL	7314150115334	5	11,21	660
TL AC-SA-SL	7314150115341	5	18,40	660
TL MM-SA-SL	7314150115365	5	11,21	661
TL SM 103-SA	7314150110773	1	40,25	662
TL SM 104-SA	7314150110780	1	40,25	661
TL SM 105-SA	7314150110797	1	40,25	661
TL SM 107-SA	7314150110810	1	40,25	661
TL SM 108-SA	7314150110827	1	40,25	661
TL SM 109-SA	7314150110834	1	40,25	661
TL SM 110-SA	7314150110841	1	40,25	661
TL SM 111-SA	7314150110858	1	40,25	661
TL SM 115-SA	7314150110896	1	40,25	662
TL SM 117-SA	7314150110919	1	40,25	662
TL SM106-SA	7314150523368	1	23,71	661
TL SM116-SA	7314150523382	1	23,71	661
TL SM116-SA-ET	7314150523405	1	40,53	659
TL SS-SA	7314150109937	1	36,70	657
TL SS-SA-SL	7314150115358	5	18,36	660
TR0325M03X-50	7314150501632	5	22,55	148
TR0636M06X-65	7314150501663	5	41,96	148
TR0650M06X-80	7314150501694	5	47,14	148
TR0860M08X-110	7314150507269	5	62,06	148
TR4.530M06X-90	7314150501755	5	40,29	148
TRX 8180	7314150112272	5	56,51	654
TSS120	7314150347063	1	219,12	112
TSS600	7314150346417	1	219,12	112
W-S-1.5	7311518140816	4	20,13	601
W-S-2.0	7311518140823	4	25,65	601



W-S-2.5	7311518140830	4	31,83	601
W-T-2.0	7311518140847	4	57,94	601
WBB1000	7314150431502	4	41,55	612
WBB1200	7314150431519	4	48,08	612
WBB1500	7314150431526	4	64,08	612
WBB400	7314150315215	10	19,41	612
WBB500	7314150315222	10	20,71	612
WBB600	7314150315239	10	22,00	612
WBB700	7314150315246	6	23,94	612
WBB800	7314150340972	6	27,18	612
WBF380	7314150315253	12	20,71	612
WBMF190	7314150315260	24	10,29	612
WBMF190IP	7314150457960	15	10,62	612
WBP-3P-3FMF	7314150444335	1	67,17	612
WBP-3P-6FMF	7314150453115	1	77,00	613
WBP-3P-96F	7314150453108	1	148,09	613
WBP300	7314150315161	20	37,53	612
WBP500	7314150315178	12	41,41	612
WBP625	7314150315185	12	54,36	612
WBP710	7314150315192	10	60,82	612
WBP900	7314150315208	6	89,30	612
WC-HOL	7314150333158	1	4,13	573
WPH 2-50	7314150520428	1	136,99	609
WPH 3-20	8412814125435	1	33,29	609
WPH 3-30	8412814125442	1	44,71	609
WR1	7314150167425	50	4,66	543
WR1-MM	7314150220069	50	4,67	543
WR2	7314150167432	25	6,21	543
WR2-12	7314150185627	25	6,21	543
WR2-MM	7314150220038	25	7,48	543
XLARGE	7314150437412	1	6.863,17	375
XXL	7314150504152	1	7.956,75	374
ZHVIDEOBAT	8414909180244	1	69,95	360
ZHVIDEOCHA	8414909180237	1	28,56	360



Bimetal y Metal duro

		Anchura de la sierra de cinta							
		≤ 20 mm €	27 mm €	34 mm €	41 mm €	54 mm €	67 mm €	80 mm €	100 mm €
BIMETAL	3851 SANDFLEX® Cobra	6,70	7,47	8,55	8,55	17,82	21,12	21,12	*
	3851 SANDFLEX® Cobra PSG	*	7,47	8,55	8,55	17,82	*	*	*
	3853 SANDFLEX® Top Fabricator™	6,70	7,47	8,55	8,55	17,82	21,12	*	*
	3854 SANDFLEX® King Cobra PHG	*	7,47	8,55	8,55	17,82	21,12	21,12	*
	3857 SANDFLEX® Easy-Cut	6,70	7,47	8,55	*	*	*	*	*
	3858 PHX	*	*	8,55	8,55	17,82	21,12	21,12	*
METAL DURO	3860 Unset carbide	*	7,47	8,55	8,55	17,82	21,12	21,12	21,12
	3868 Carbide Triple Set® "Xtra"™	*	7,47	8,55	8,55	17,82	21,12	21,12	*
	3869 Carbide Triple Set®	6,70	7,47	8,55	*	*	*	*	*
	3881 Carbide Triple High Quad	*	*	8,55	8,55	17,82	21,12	21,12	21,12

Condiciones de Venta

1. Las presentes Condiciones Generales estarán en vigor desde 02-2024 y vienen a sustituir y dejar sin efecto a todas las Condiciones Generales anteriormente aplicadas.

2. Nuestros productos se identifican, exclusivamente, por sus referencias. Por ello, los pedidos deben mencionar, claramente en cada caso, la referencia y el número de unidades de la misma que se desea adquirir. Una vez aceptado el pedido, la obligación de SNA Europe Industries Iberia, S.A. queda limitada al suministro de dichas unidades de la referencia solicitada. Las dimensiones y características técnicas de los productos que se incluyen en nuestro catálogo comercial, son meramente ilustrativas y están sujetas a modificaciones, por lo que SNA Europe Industries Iberia, S.A. recomienda a sus clientes que, antes de formular un pedido, comprueben que la referencia solicitada se ajusta, en cuanto a dimensiones y demás características a sus necesidades.

3. SNA Europe establece un importe mínimo por pedido de 100 € para la aceptación de los mismos.

4. Los pedidos inferiores a 450 € en Península y 680 € para Canarias, Ceuta y Melilla, se enviarán a portes pagados, cargando en factura el coste de este servicio.

5. Los precios para envíos a las provincias españolas fuera de la península se entienden para mercancía puesta en el puerto de destino (C & F).

6. La elección del medio de transporte será por cuenta de SNA Europe Industries Iberia, S.A.

7. Los clientes tienen la obligación de examinar los productos servidos a su recepción, a fin de comprobar su conformidad con el pedido en cuanto a la referencia o referencias servidas y el número de unidades entregadas. Si existiera alguna disconformidad, el cliente deberá ponerlo de manifiesto, bien rechazando la mercancía si su disconformidad es total, bien recibéndola parcialmente y haciendo constar en el albarán de entrega su queja en cuanto al producto rechazado en el caso de disconformidad parcial. La firma del albarán de entregas, sin salvedad alguna, supondrá la aceptación de la mercancía y la conformidad del cliente en cuanto a la cantidad y referencia(s) servida(s), todo ello sin perjuicio de la garantía de producto aquí prevista.

8. La transmisión de la propiedad de la mercancía en favor del cliente no tendrá lugar hasta el momento de la efectividad del completo pago de su precio, con independencia de que la misma haya sido entregada y puesta a disposición del cliente. En este caso, y hasta la efectiva transmisión de la propiedad mediante el pago, el cliente se abstendrá de realizar cualquier acto de disposición sobre la mercancía o de almacenarla y/o utilizarla de forma tal que pueda sufrir algún menoscabo, siendo responsable frente a SNA Europe Industries Iberia, S.A. del estado de la misma en este tiempo. En el supuesto de que, llegado el vencimiento del pago, este no se haga efectivo por el cliente, SNA Europe Industries Iberia, S.A. tendrá la facultad alternativa de exigir el pago del precio, con sus intereses o la devolución de la mercancía, sin perjuicio en cualquiera de ambos casos de las indemnizaciones de daños y perjuicios a la que por ley tenga derecho.

9. La mercancía será servida en función de las circunstancias del pedido (Número de unidades y clase de la referencia solicitada) y de la disponibilidad de producto de SNA Europe Industries Iberia, S.A. en el momento. Si el cliente precisa que la entrega se realice en un plazo determinado deberá ponerlo de manifiesto en su escrito de pedido, no habiendo lugar a ninguna reclamación por retraso en la entrega, salvo que expresamente se pacte otra cosa.

10. Forma de pago: A 60 días fecha factura. Los clientes que tengan día de vencimiento fijo, se les girará al más próximo a los 60 días fecha factura, de forma que todos los giros quedarán comprendidos entre los 45 y 75 días f.f.

11. Los pedidos, una vez aceptados por SNA Europe Industries Iberia, S.A., serán irrevocables y no podrán ser anulados o modificados de ninguna manera por el cliente, salvo que medie expreso acuerdo en dicho sentido con SNA Europe Industries Iberia, S.A. Si un pedido, por la especial naturaleza de su objeto u otras circunstancias, requiere alguna clase de cambio en los procesos de fabricación y/o envasado normalmente seguidos por SNA Europe Industries Iberia, S.A., se considerará como definitivo e irrevocable en todos sus conceptos desde el mismo momento de su emisión por el cliente, viniendo éste obligado a la recepción de la mercancía en todo caso. De no hacerlo así y rehusar la mercancía SNA Europe Industries Iberia, S.A. podrá exigirle el precio del pedido, más un 50% del mismo, en concepto de penalización.

REPOSICIÓN DE GARANTÍA

1. Todos los productos del catálogo están amparados por la Garantía Total contra cualquier defecto de fabricación o material, de forma que los clientes tendrán derecho a la reposición de la pieza o piezas defectuosas siempre que el defecto tenga su origen directo en la fabricación o de material de la misma.

2. El derecho de reposición se limita a la sustitución de la pieza defectuosa por otra nueva y no comprenderá abono de ninguna clase, siendo todos los gastos de la reposición, en particular el transporte, de cargo del cliente.

3. La Garantía Total no ampara los defectos provenientes del desgaste o de la mala conservación y/o utilización de los productos por el cliente.

4. El plazo de garantía es de un año a partir de la fecha de compra en el caso de los productos sujetos a desgaste normal con el uso tales como cuchillas, puntas, brocas, y otros productos consumibles. En el caso de multiplicadores de par, la garantía no se aplicará en los casos en los que el producto haya sido sometido a esfuerzos superiores a sus valores nominales máximos.

5. Para el correcto ejercicio de este derecho el cliente deberá comunicar por escrito a SNA EUROPE INDUSTRIES IBERIA, S.A. el defecto y las piezas afectadas, indicando los datos relativos a la compra (fecha y número de factura). En el plazo de 30 días a contar desde la recepción de dicha comunicación, SNA EUROPE INDUSTRIES IBERIA, S.A. enviará a su representante de plaza a las instalaciones del cliente, a fin de suscribir conjuntamente la documentación relativa a las piezas defectuosas. Inmediatamente después las mismas o una muestra escogida por el representante de plaza, serán remitidas a SNA EUROPE INDUSTRIES IBERIA, S.A. a fin de que su Departamento de Calidad certifique el defecto. En el supuesto de que el informe del Departamento de Calidad confirme el defecto, SNA EUROPE INDUSTRIES IBERIA, S.A. lo comunicará al cliente, anunciando la reposición de las piezas defectuosas.

6. La reposición se llevará a cabo en el menor plazo de tiempo posible y como norma se producirá junto con el más próximo envío de mercancía al cliente.

7. A la recepción de las piezas repuestas, el cliente deberá suscribir un documento manifestando su conformidad con la reposición efectuada y se renuncia a cualquier reclamación ulterior a SNA EUROPE INDUSTRIES IBERIA, S.A. por dicho motivo.



Contacto

Argentina

A.M. de Justo 1750 3° A
C1107AFJ - Capital Federal
Buenos Aires
Tel: +54 (11) 4313-1004
Fax: +54 (11) 4893-3553

Australia

3 Cooper Street, Smithfield,
NSW 2164
Tel: +61 (0) 2 8787 5700
Fax: +61 (0) 2 9756 6130

Беларусь

ЗАО "Эс-Эн-Эй Европа Индастриз Бисов"
220075 СЭЗ "Минск"
ул. Селицкого, д. 8А
Телефон +375 (17) 389 79 50
info.by@snaeurope.com

Belgium

Branch of SNA Europe (Benelux) BV
De Kleetlaan 12А Pegasus Park
1831 DIEGEM
Tel: +32 (0)2 726 03 03
info.be@bahco.com

Chile

Av. Americo Vesputio 2760-D
Conchali - Santiago - Chile
Tel: + 56 2 623 0203
Fax: + 56 2 623 5395

Česká republika

SNA Europe s.r.o.
Holadnská 2/4
639 00 Brno
Tel: +420 537 022 520
Fax: +420 537 022 200

Danmark

Vallensbækvej 40,
2605 Brøndby
Tel: +45 4363 0330
Fax: +45 4396 2456

Deutschland

Willetstraße 10
40822 Mettmann
Tel: +49 (0) 2104 833 83 0
Fax: +49 (0) 2104 833 83 7999

España

c/ Hilanderas, 1
(P.O. Box / Ardo de Correos nº 5)
C.P. 20303 Irún
Tel: +34 902 235 100 / +34 943 649 111
Fax: +34 943 649 120

Ελλάδα

Λ. Βουλιαγμένης 604Γ
167 77 Ελληνικό, Αθήνα
Τηλ: +30 210 9914263
Fax: +30 210 9914587

Export

Antigua Carretera de Altube Km 5,5
P.O.Box 307
01080 VITORIA (Spain)
Tel: +34 945269711
Fax: +34 945165040

France

ZAC de l'Hoirie
20 rue Charles Lacretelle
CS 60101
49072 Beaucouzé cedex
Tél: +33 (0) 2 41 22 98 40
Fax: +33 (0) 2 41 22 98 50

Italia

SNA EUROPE Italia S.p.A.
Via Georges Bizet, 13/15
20092 Cinisello Balsamo MI - Italia
Tel. +39 02 3024161
info.it@snaeurope.com

Казахстан

050000, Алматы,
ул.Шевченко 1656/72г, оф.217
Тел/факс +7 727323 63 39

Nederland

Vossenbeemd 113
5705 CL Helmond
Tel: +31 (0) 492 58 23 82
info.nl@bahco.com

New Zealand

Unit 3/25 Highbrook Drive
East Tamaki
Auckland
Tel: +64 9-273 46 50
Fax: +64-9-273-2453

Norge

Box 800
1306 Sandvika
Tel: +47 40 49 66 00

Österreich

Vienna, Nineteen, Mooslackengasse 17
A - 1190 Wien
Tel: +49 (0) 2104 8 33 83 0
Fax +49 (0) 2104 833 83 79 99

Polska

ul. Marynarska 15
02-674 Warszawa
Tel.: +48 (0) 22 6070510
Fax: +48 (0) 22 6070521

Россия

ООО "Эс-Эн-Эй Юроп (РУС)"
141407 г. Химки
ул. Панфилова вл.21, стр.1
Телефон +7 (495) 221 58 51
info.ru@snaeurope.com

Portugal

SNA Europe [Industries] LDA
R. Maria Julia M. Ramos - Junqueira
4480-254 Vila Do Conde
Tel. +351 252 650 131
Fax. +351 252 650 160

Slovenská republika

SNA Europe s.r.o.
Karadžičova 8/A
821 08 Bratislava
Tel: +421 (0)2 5939 6124
Fax: +421 (0)2 5939 6217

SRBIJA

Vermax-alati doo
Ul. Drage Spasić 35
11000 Beograd
Tel: +381 11 2360 500
Tel: +381 11 2360 900
Fax: +381 11 2361 147
e-mail: office@vermax.rs

Suomi

SNA Europe Oy
PL 6580
00002 Helsinki
Finland
Tel: +358 207 433 510
Fax: +358 207 433 525

Sverige

SNA Europe Industries AB
Box 83
SE-745 22 Enköping
Tel: +46 (0) 171-47 82 00
Fax: +46 (0) 171-47 82 38

Schweiz / Suisse

Willetstraße 10
40822 Mettmann
Tel: +49 (0) 2104 833 83 0
Fax: +49 (0) 2104 833 83 7999

Türkiye

Girne Mah. Maltepe Küçük San. Sitesi
F Blok No:19 Maltepe
Istanbul
Tel: +90 (0) 216 367 10 21
Fax: +90 (0) 216 367 11 71

Украина

«Бахко Бисов Свенска Акциеболаг»
SNA Europe [Ukraine & Moldova]
Телефон +38 067 441 16 09
офис 555, улица Армянская, 6А
Киев, Украина

United Kingdom

Moorhead Way, Bramley,
Rotherham, South Yorkshire S66 1YY
Tel: +44 (0) 1709 731731
Fax: +44 (0) 1709 731741

Garantía

Para información sobre la garantía visite la página web local www.bahco.com/es_es



Este catálogo comprende nuestra gama actual de productos. De manera regular se realizan cambios tanto en la gama de productos como en el conformado final, formas, diseños y designaciones de los mismos. Estas modificaciones no serán necesariamente notificadas.

Las ilustraciones y croquis han sido reproducidos para ser lo más precisos posibles. Sin embargo, en la elaboración de un catálogo, los mismos pueden diferir respecto a los propios productos y a las especificaciones técnicas.

Las indicaciones de peso deben entenderse como pesos netos aproximados, y sirven principalmente para facilitar el cálculo de los costes de transporte y franqueo.

Este catálogo reemplaza todas las especificaciones y gamas previas.

La propiedad intelectual de este catálogo pertenece a SNA Europe.

Los extractos, reimpresiones o copias de los contenidos solo se pueden realizar con nuestra autorización.

2024





www.bahco.com

M-320-PRI-24



7 314150 546763

Este catálogo tarifa es válido únicamente para España